

MAGNETOSCOPE VCR 6100



VCR-6100

Magnéscope VHS-HQ SECAM à chargement frontal.

Compatibilité Canal + (2 prises Péritel).

Programmation 6 événements sur 1 mois.

Télécommande infrarouge avec double système de programmation :

- codes à barre, utilisables avec la plupart des magazines TV.
- Programmation conversationnelle sur écran Easy Programmer.

Double système d'indexation (manuel / automatique au début et à la fin de chaque enregistrement) vous permettant de retrouver facilement le début d'un film ou un endroit quelconque sur la bande.

Touche d'enregistrement instantané.

Recherche rapide avant-arrière avec visualisation.

- Alimentation : 220 V.

- Consommation : 34 Wh.
- Dimensions : L420 x H90 x P315 mm.
- Livré avec télécommande.

Pour toute information appelez le 46.26.08.83 ou composez le 3615 AMSTRAD sur votre minitel.



TABLEAU CARACTERISTIQUES GAMME VIDEO

		VCR 4600	VCR 4800	VCR 6000	VCR 6100	TVR 2	TVR 3	
	Système	VHS	VHS	VHS	VHS	VHS	VHS	
	Standard	SECAM	SECAM	SECAM	SECAM	SECAM	SECAM	
	Norme	L	L	L	L	L	L	
	Circuit HQ	OUI	OUI	OUI	OUI	OUI	OUI	
	Nbre de têtes	2	2	2	2	2	2	
Affichage								
	Compteur	OUI	OUI	OUI	OUI	OUI	OUI	
	Heure	OUI	OUI	OUI	OUI	OUI	OUI	
	N° chaîne	OUI	OUI	OUI	OUI	OUI	OUI	
	Heure de début/fin d'enregistrement	OUI	OUI	OUI	OUI	OUI	OUI	
	Date de programmation	-	-	-	-	-	OUI	
	Témoin de programmation	OUI	OUI	OUI	OUI	OUI	OUI	
Tuner magnétoscope								
	Chaînes mémorisables	32	32	32	32	16	32	
	Système de recherche des émetteurs	OUI	OUI	OUI	OUI	-	OUI	
	Synthèse de tension	OUI	OUI	OUI	OUI	OUI	OUI	
Utilisation courante								
	Recherche visuelle rapide avant/arrière à deux vitesses (x3 & x5)	OUI	OUI	OUI	OUI	OUI	OUI	
	Pause sur image	OUI	OUI	OUI	OUI	OUI	OUI	
	Rembobinage automatique en fin de bande	OUI	OUI	OUI	OUI	OUI	OUI	
	Indexation manuelle	-	-	-	OUI	-	-	
	Indexation automatique de début et fin d'enregistrement	-	-	-	OUI	-	-	
Programmation								
	Nombre de programmations par périodes	6/14	6/14	6/14	6/1 mois	6/14	6/14	
	Programmation directe	OUI	OUI	OUI	OUI	OUI	OUI	
	Programmation quotidienne et hebdomadaire	OUI	OUI	OUI	OUI	OUI	OUI	
	Programmation par télécommande	-	OUI	CONVERSATIONNELLES		-	-	
	Programmation par code à barres	-	-	-	OUI	-	-	
Télécommande								
	Affichage à cristaux liquides	OUI	OUI	OUI	OUI	OUI	OUI	
	Conversationnelle (questions/réponses)	-	-	OUI	OUI	-	-	
	Lecteur de code à barres intégré	-	-	-	OUI	-	-	
	Indexation manuelle	-	-	-	OUI	-	-	
	Recherche visuelle rapide avant/arrière	OUI	OUI	OUI	OUI	OUI	OUI	
	Avance/retour rapide	OUI	OUI	OUI	OUI	OUI	OUI	
	Pause/image	OUI	OUI	OUI	OUI	OUI	OUI	
	Mise en veille	OUI	OUI	OUI	OUI	OUI	OUI	
Divers								
	Antenne 75 Ohms co-axiale	OUI	OUI	OUI	OUI	OUI	OUI	
	Prises péricels	2	2	2	2	2	2	
	Compatibilité Canal +	OUI	OUI	OUI	OUI	OUI	OUI	
	Alimentation secteur	220 V/50 Hz	220 V/50 Hz	220 V/50 Hz	220 V/50 Hz	220 V/50 Hz	220 V/50 Hz	
	Consommation	37	37	34	34	86	110	
	Poids (Kg)	6,5	6,5	5,7	5,7	16	26,5	
	L	420	420	420	420	370	480	
	Dimension en mm h	100	100	90	90	410	510	
	p	310	310	315	315	365	465	
Partie téléviseur								
						Tube	36 cm	51 cm
							90 °	90 °
						Glace de protection	-	OUI
						Incrustation des chaînes	OUI	OUI
						Volume, sélecteur de chaîne, M/A en façade	OUI	OUI
						Répétition de la lecture cassette	OUI	OUI
						Nbre de chaînes	-	16
						Prise péricel	-	OUI

AMSTRAD

FIDELITY

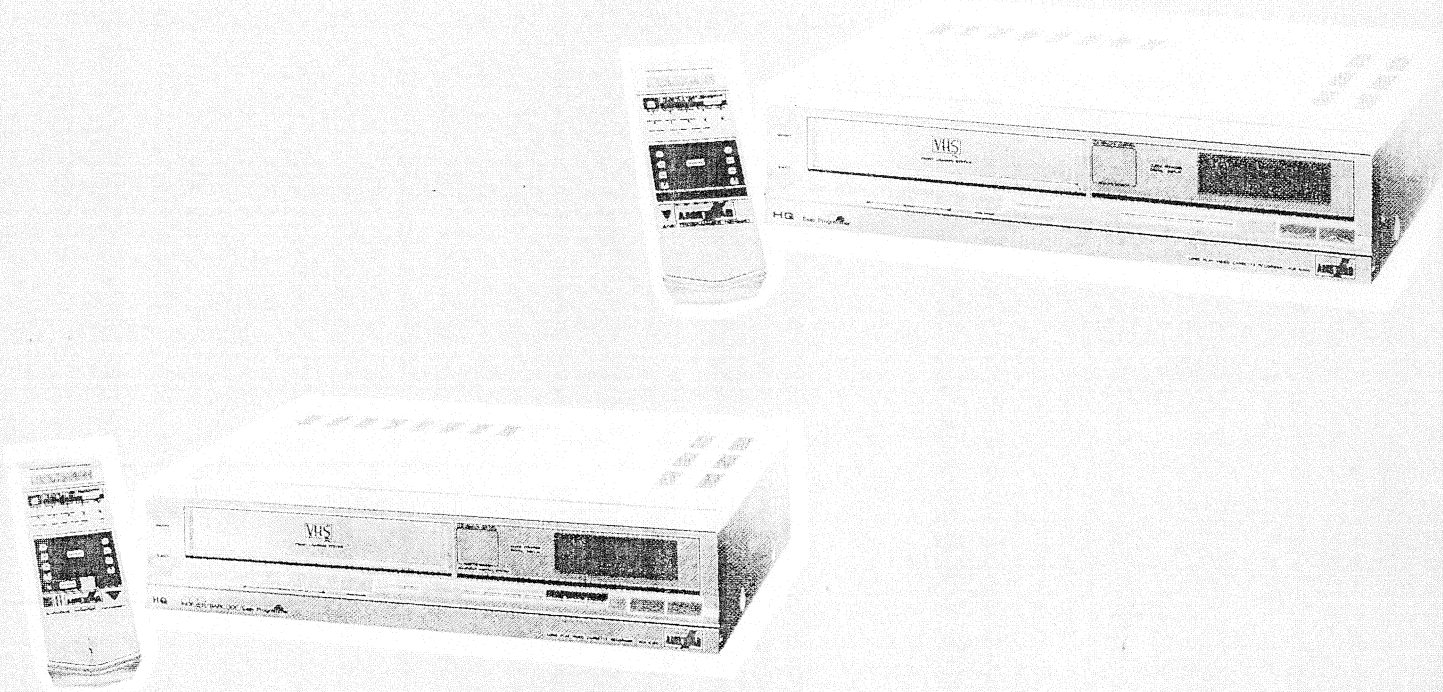

VCR6000/6100 VIDEO CASSETTE RECORDER SERVICE MANUAL

4-2 CLEANING

1. CLEANING OF VIDEO HEAD

Head cleaning by using a chamois skin.

— Procedure —

- (1) Remove the top cabinet.
- (2) Put on a glove (thin type) to avoid touching the upper drum and lower drum with bare hand.
- (3) Put a few drops of alcohol on the Chamois skin, and by slightly placing it against the head tip, allow the upper drum to turn the right and left.

— Remark —

- (1) The video head is of very hard material, but since it is very thin, avoid cleaning it vertically.
- (2) Wait for the cleaned part to dry out, before operating the unit.
- (3) Do not reuse the stained chamois skin.

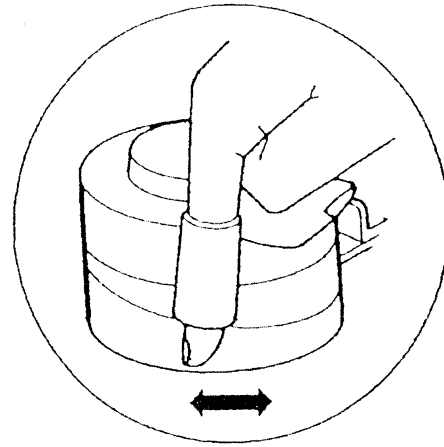

2. CLEANING OF AUDIO CONTROL HEAD

Head cleaning by using a chamois skin.

— Procedure —

- (1) Remove the Top Cabinet.
- (2) Put a few drops of alcohol on the chamois skin. Clean up the audio control head, being careful not to damage the upper drum and other tape running parts.

— Remark —

- (1) Avoid cleaning audio control head vertically.
- (2) Wait for the cleaned part to dry well, before operating the unit.

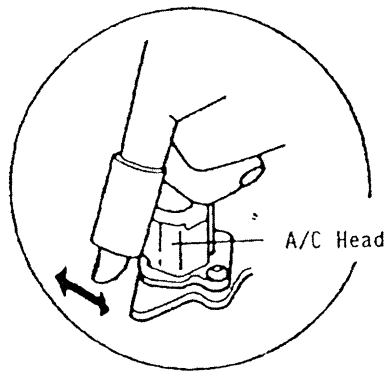

5. MECHANICAL ADJUSTMENT VCR6000

5-1 TAPE TRANSPORT ADJUSTMENT FLOW CHART

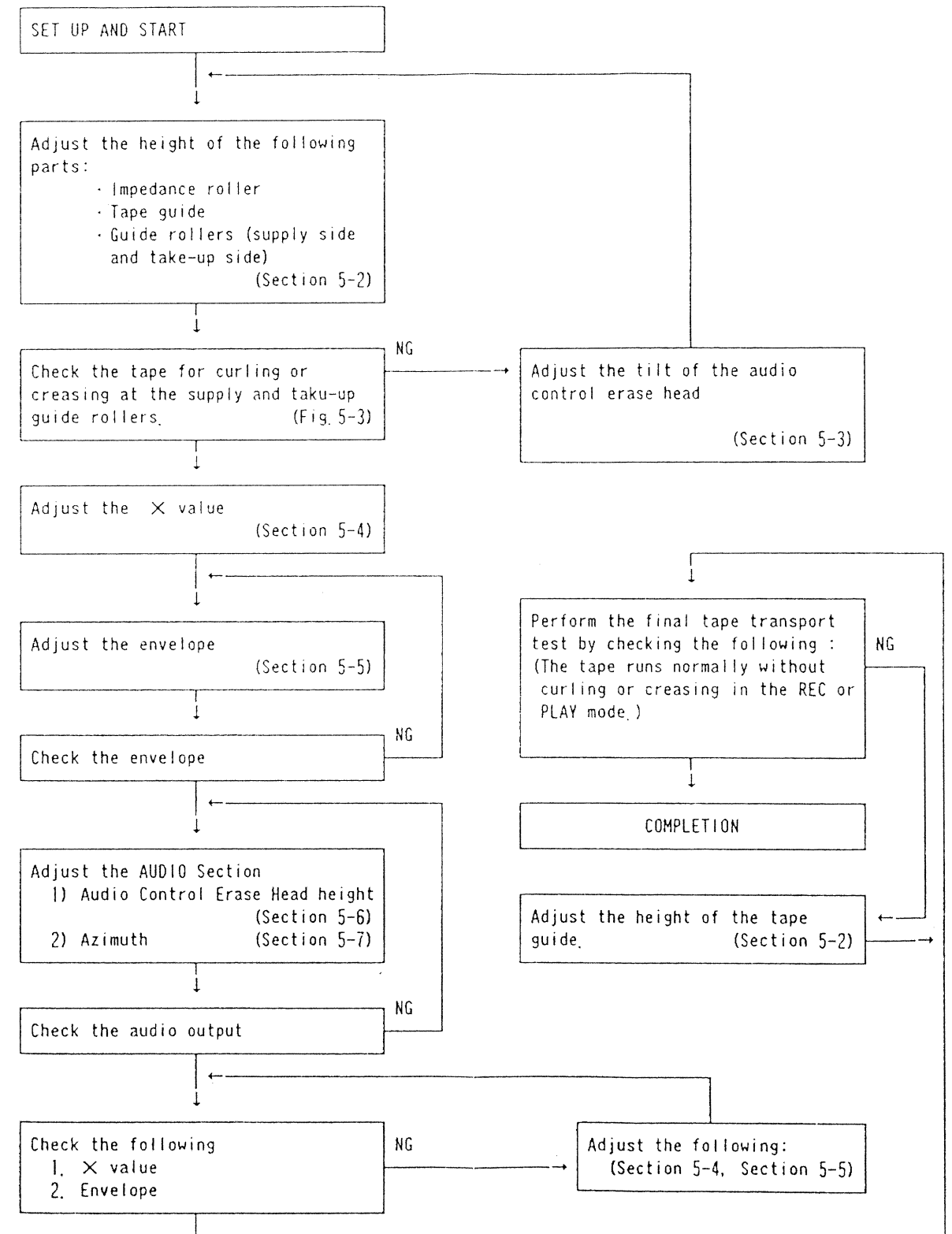

WAVE FORMS VCR6000/6100

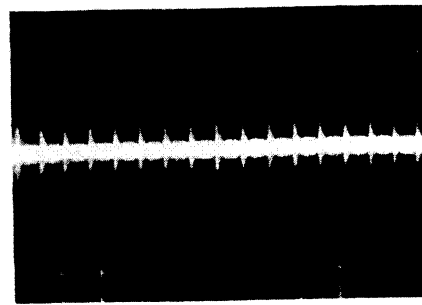

① 0.1mS/div 5mV/div
Mode : REC
Test Tape : Blank Tape
HIC51 Pin 25

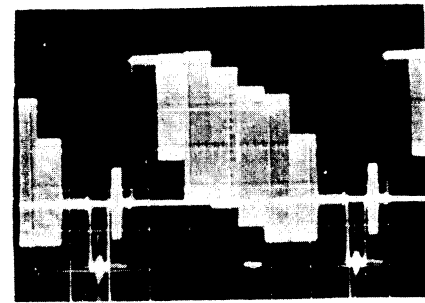

② 10mS/div 20mV/div
Mode : REC
Test Tape : Blank Tape
TP-21

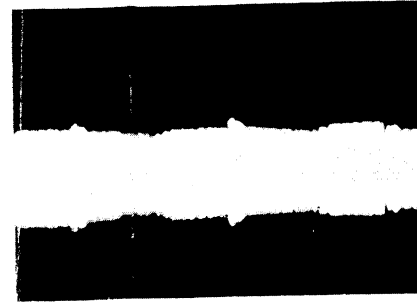

③ 5mS/div 20mV/div
Mode : PLAY
Test Tape : F6-A
HIC51 Pin 23

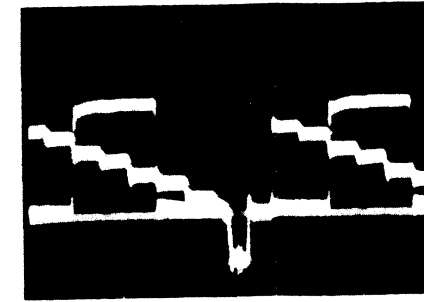

④ 10mS/div 20mV/div
Mode : PLAY
Test Tape : F6-A
TP-6

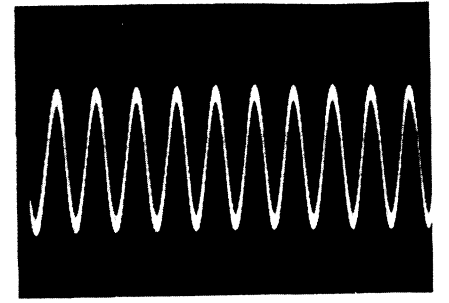

⑤ 0.2uS/div 5mV/div
Mode : PLAY
Test Tape : F6-A
HIC101 Pin 6

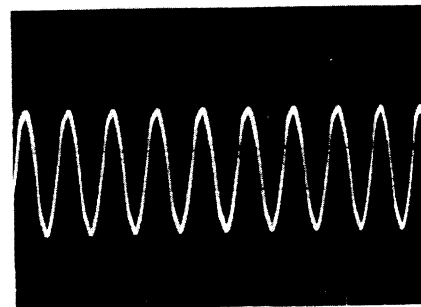

⑥ 0.2uS/div 20mV/div
Mode : PLAY
Test Tape : F6-4
HIC101 Pin 1



⑦ 2mS/div 10mV/div
Mode : PLAY
Test Tape : F6-A
IC1 Pin 9



⑧ 20uS/div 10mV/div
Mode : REC
Test Tape : Blank Tape
HIC101 Pin 18

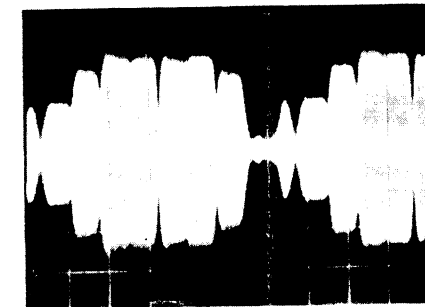

⑨ 10uS/div 20mV/div
Mode : PLAY
Test Tape : F6-A
HIC51 Pin 19

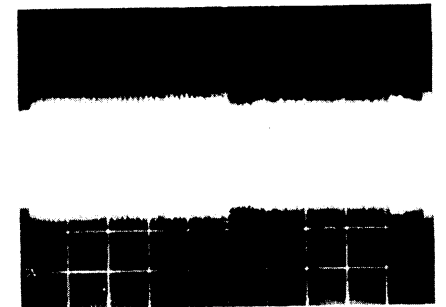

⑩ 2mS/div 10mV/div
Mode : PLAY
Test Tape : F6-A
IC1 Pin 12

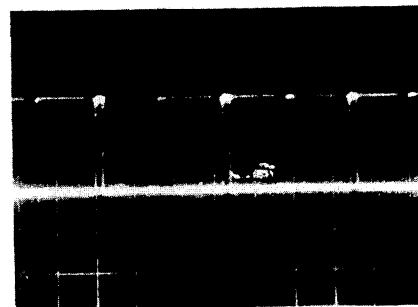

⑪ 20uS/div 0.2V/div
Mode : PLAY
Test Tape : F6-A
TP101

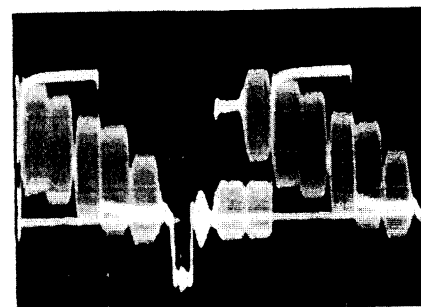

⑫ 10uS/div 10mV/div
Mode : PLAY
Test Tape : F6-A
HIC51 Pin 14

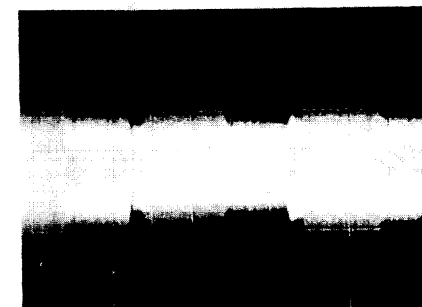

⑬ 5mS/div 10mV/div
Mode : PLAY
Test Tape : F6-A
HIC101 Pin 17

6-2 SYSTEM CONTROL/SERVO/TIMER VCR6000

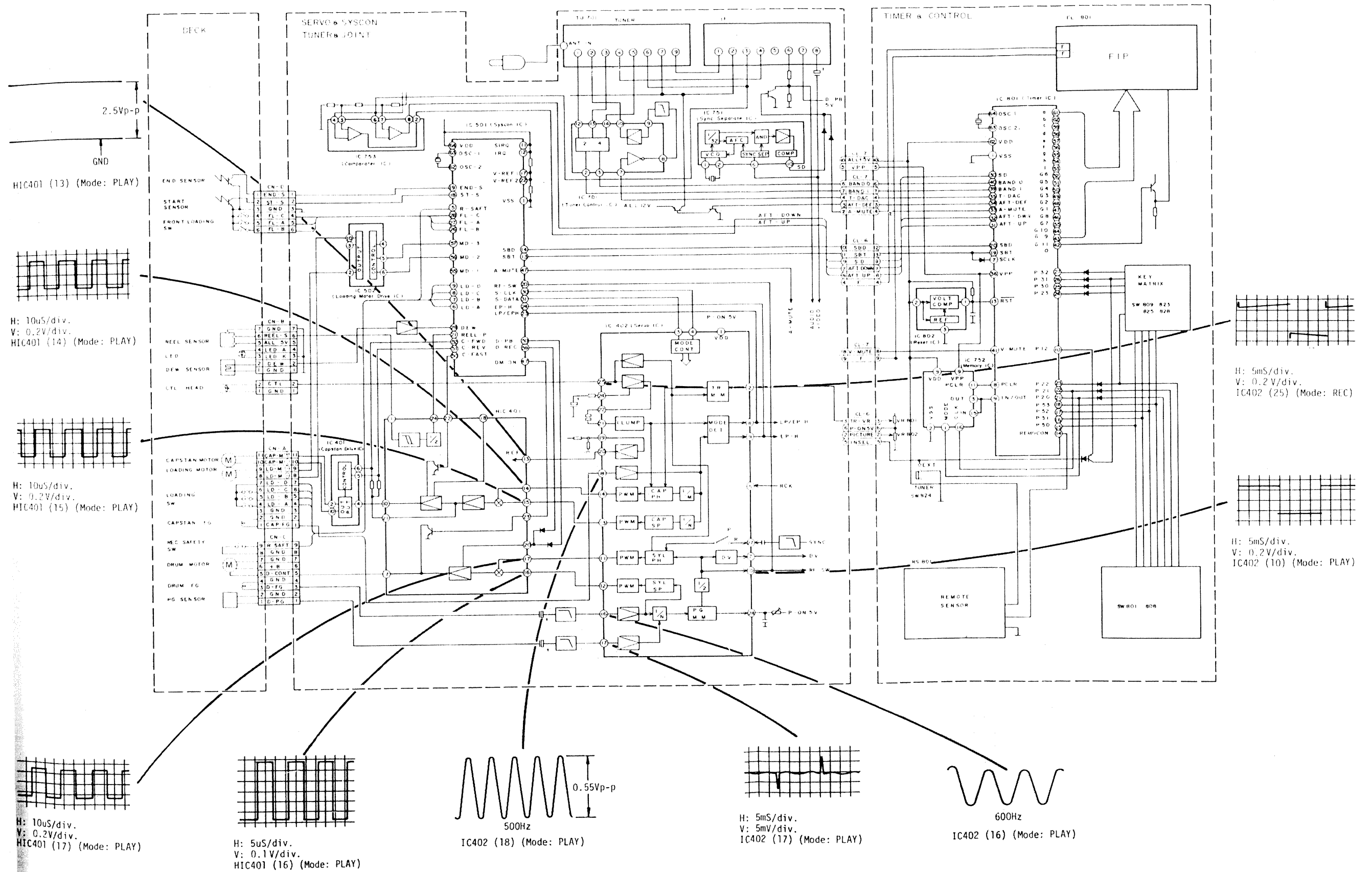

6-2 SYSTEM CONTROL/SERVO/TIMER VCR6100

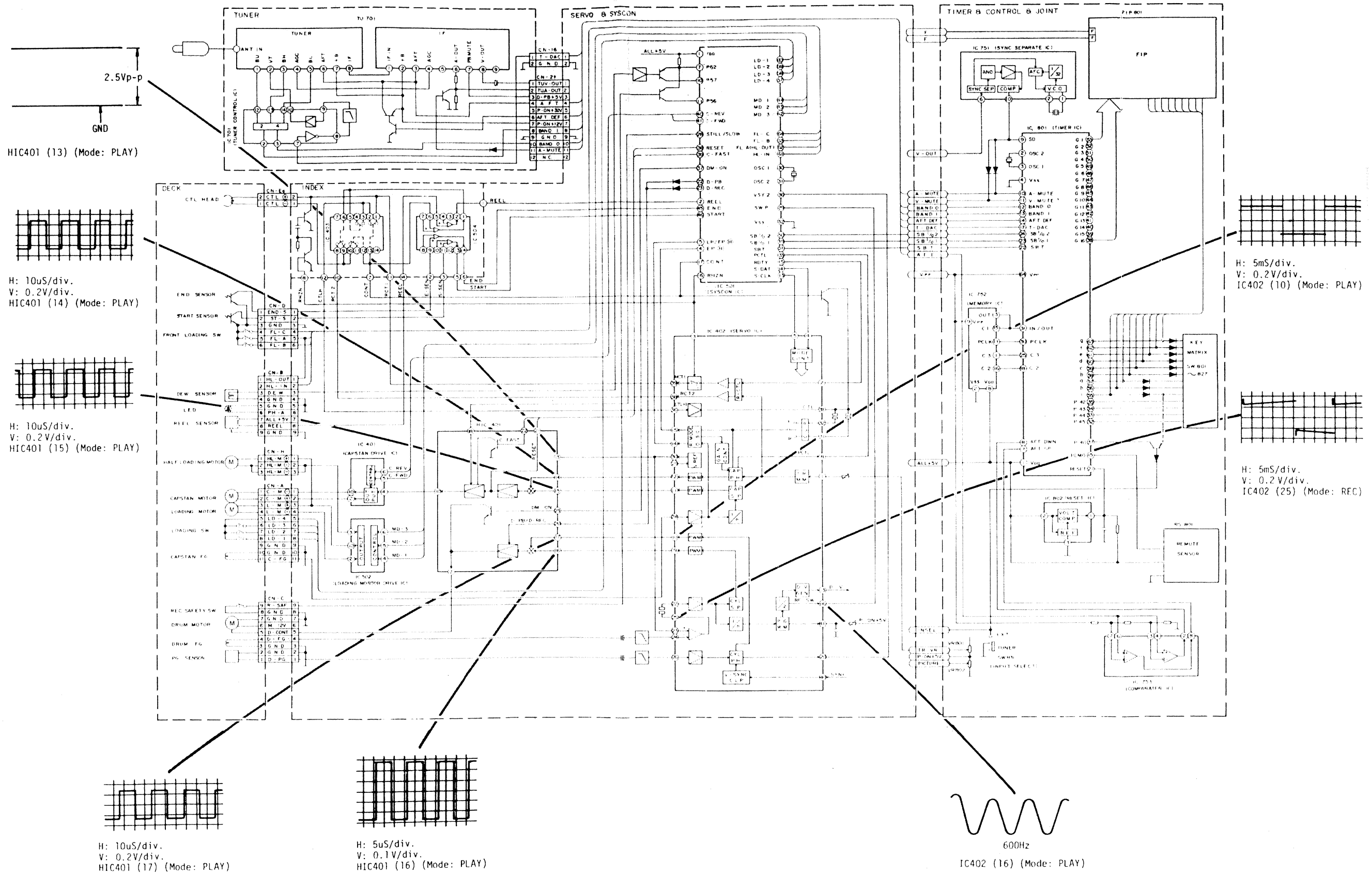

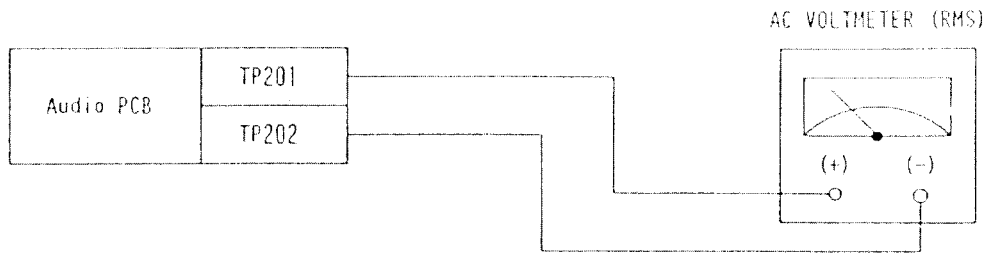

Fig. 8-5

No.	Item	Test Point	Adjustment point	Method	Connection Figure
8-5	REC. Bias Current	TP201 TP202	VR201	<ol style="list-style-type: none"> 1. Set the REC status by the blank tape. (Do not set the PAUSE. In PAUSE mode, the bias oscillation is stopped.) 2. Connect the AC voltmeter to TP201 and TP202. 3. Adjust by VR201 so that the voltage becomes 22 mV. 	Fig. 8-5

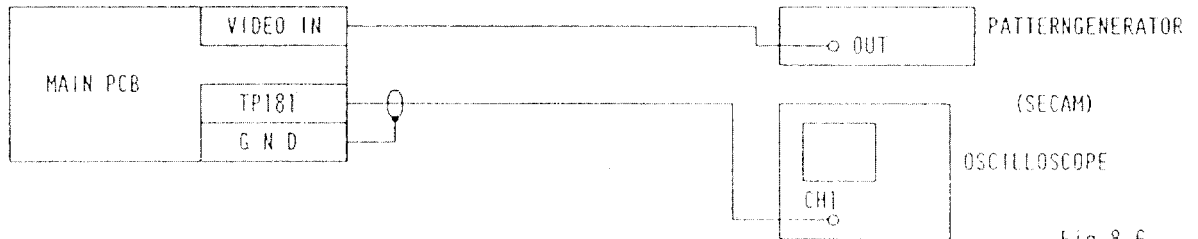
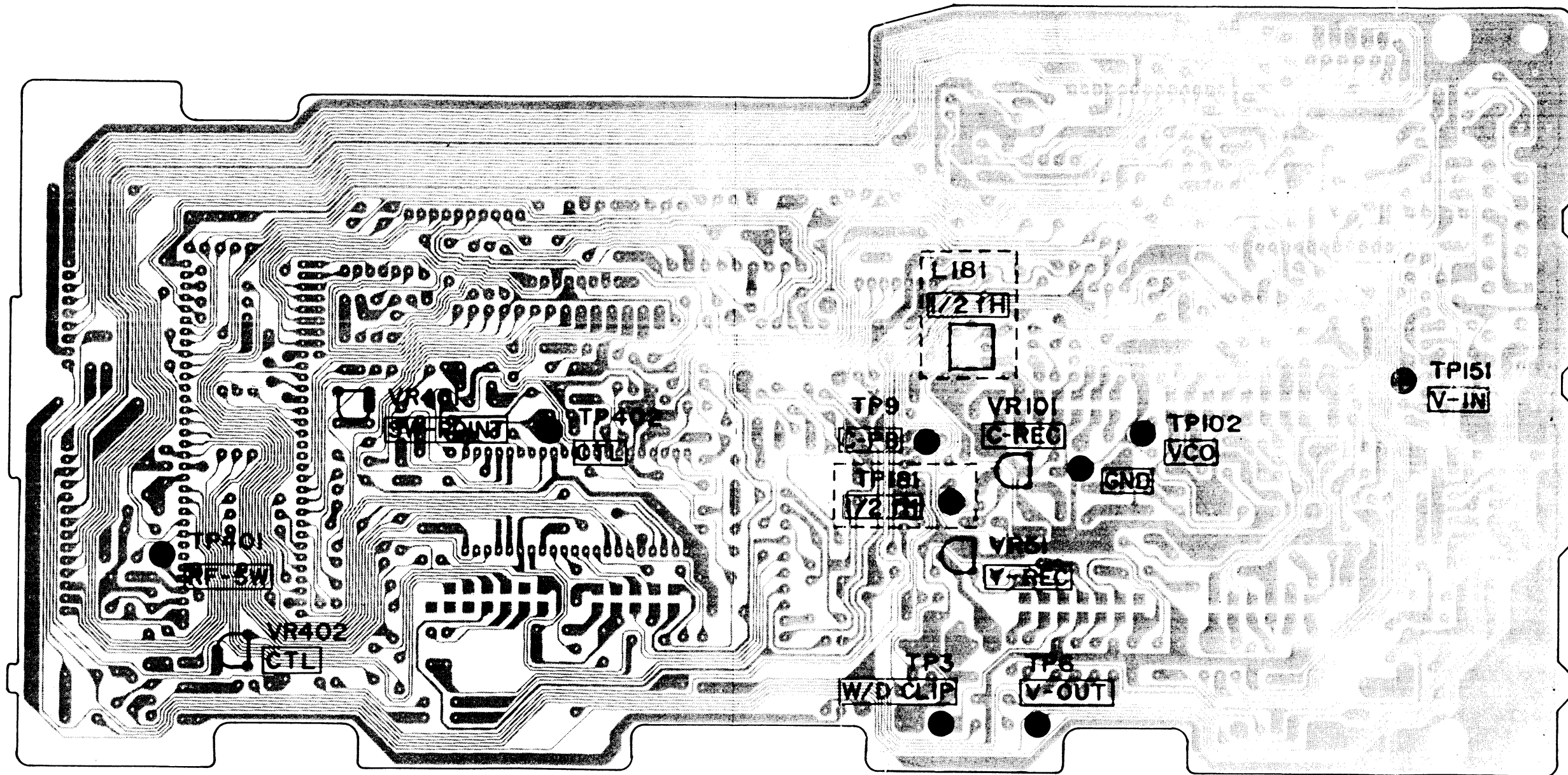

Fig. 8-6

* Note : Require this adjustment for ME-SECAM model only.

9. TEST POINT

9-1 MAIN P.C.BOARD VCR6100



9-2 TIMER P.C.BOARD VCR6000

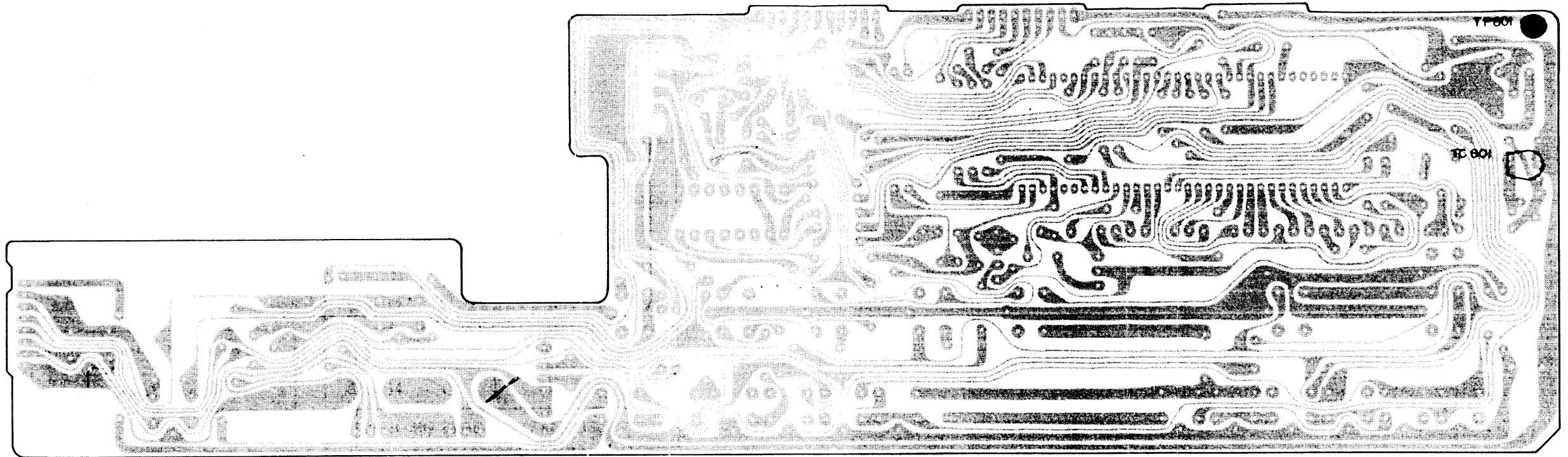

9-2 TIMER P.C.BOARD VCR6100

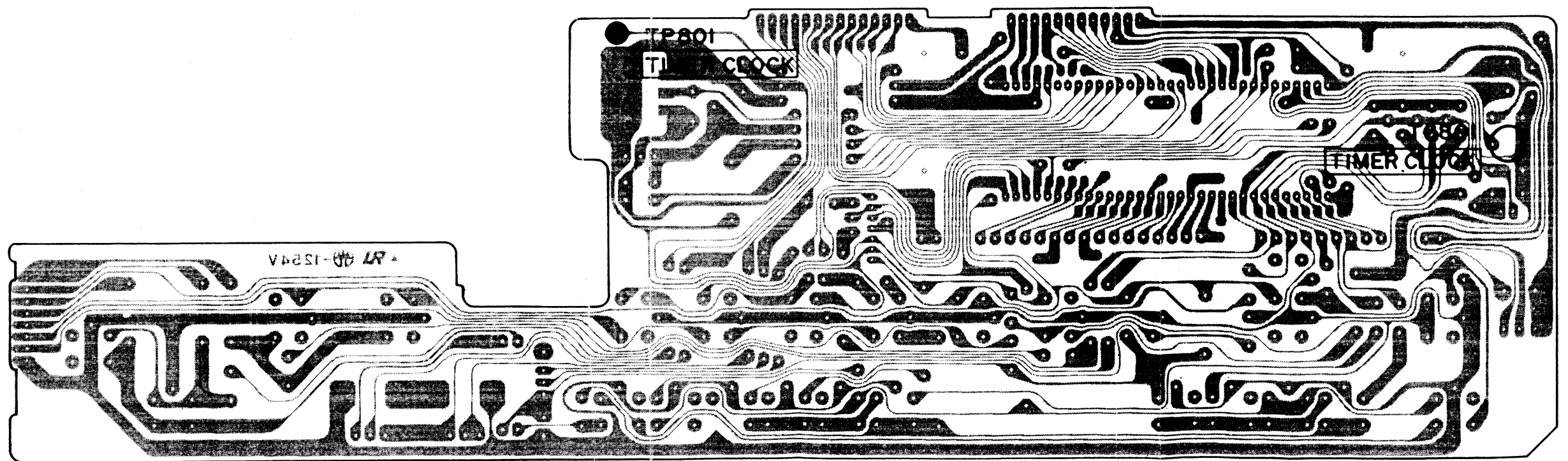

9-3 HEAD AMP P.C.BOARD VCR6000

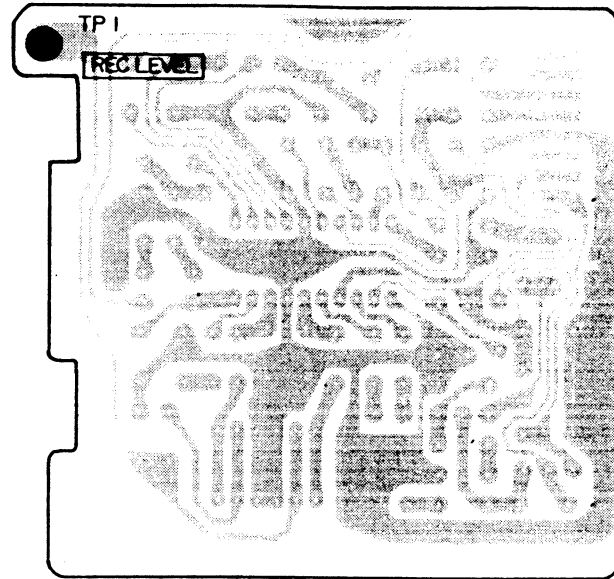

9-4 AUDIO P.C.BOARD VCR6000

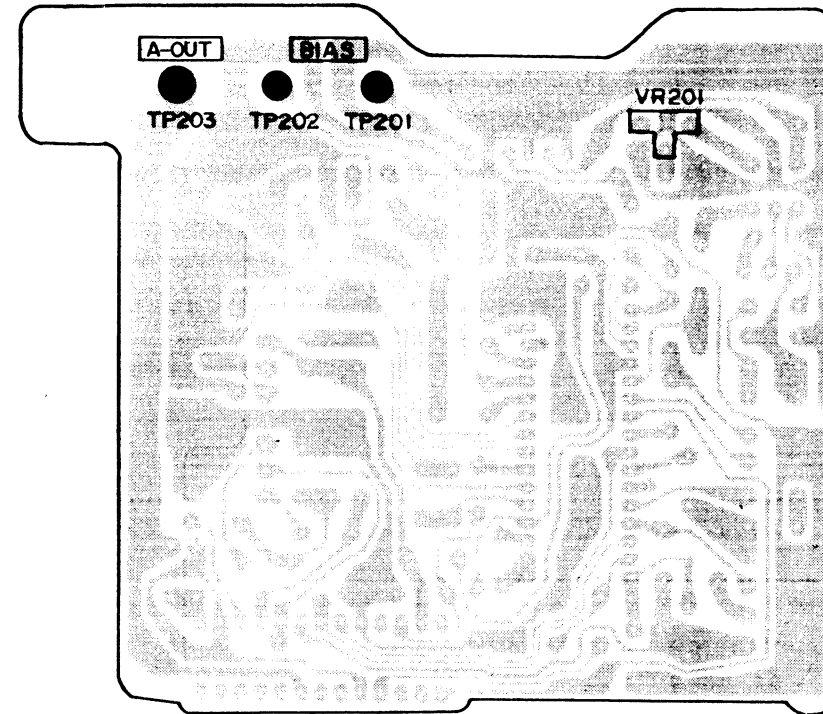

9-3 HEAD AMP P.C.BOARD VCR6100

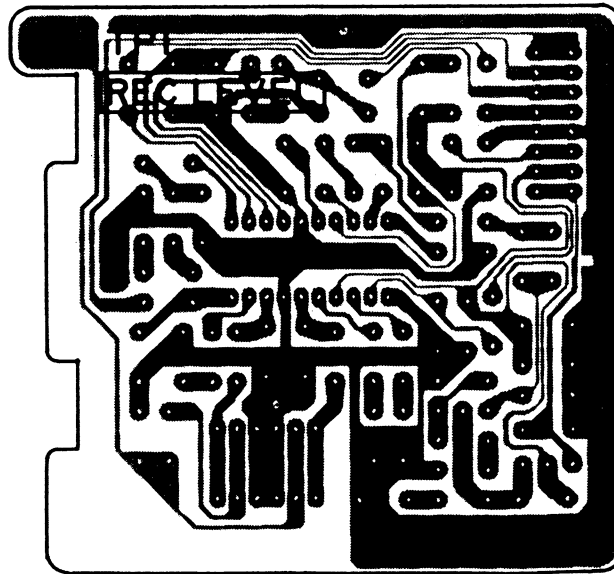

AUDIO P.C.BOARD VCR6100

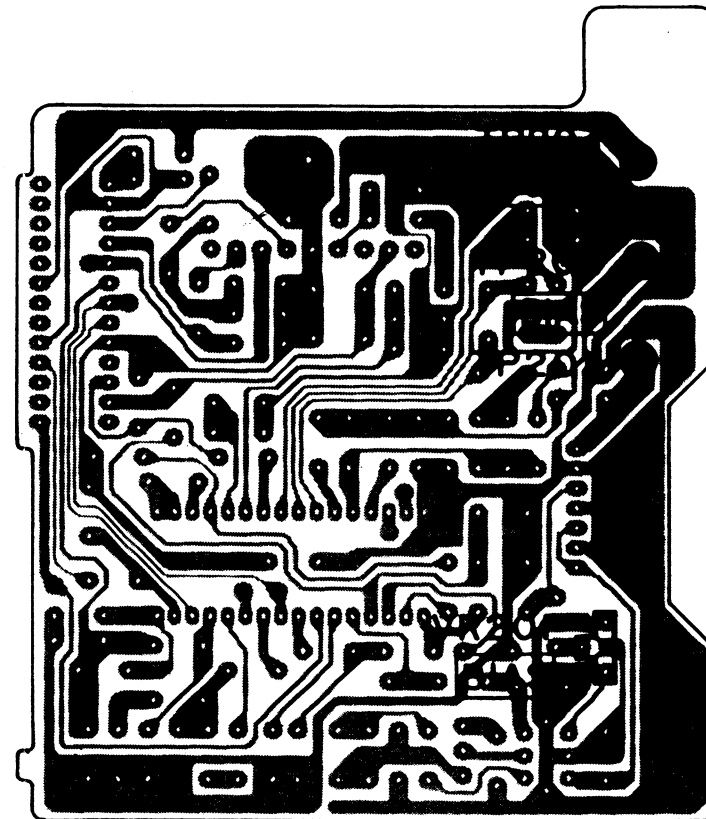

11-1-1 MAIN P.C.BOARD TOP VIEW VCR6000

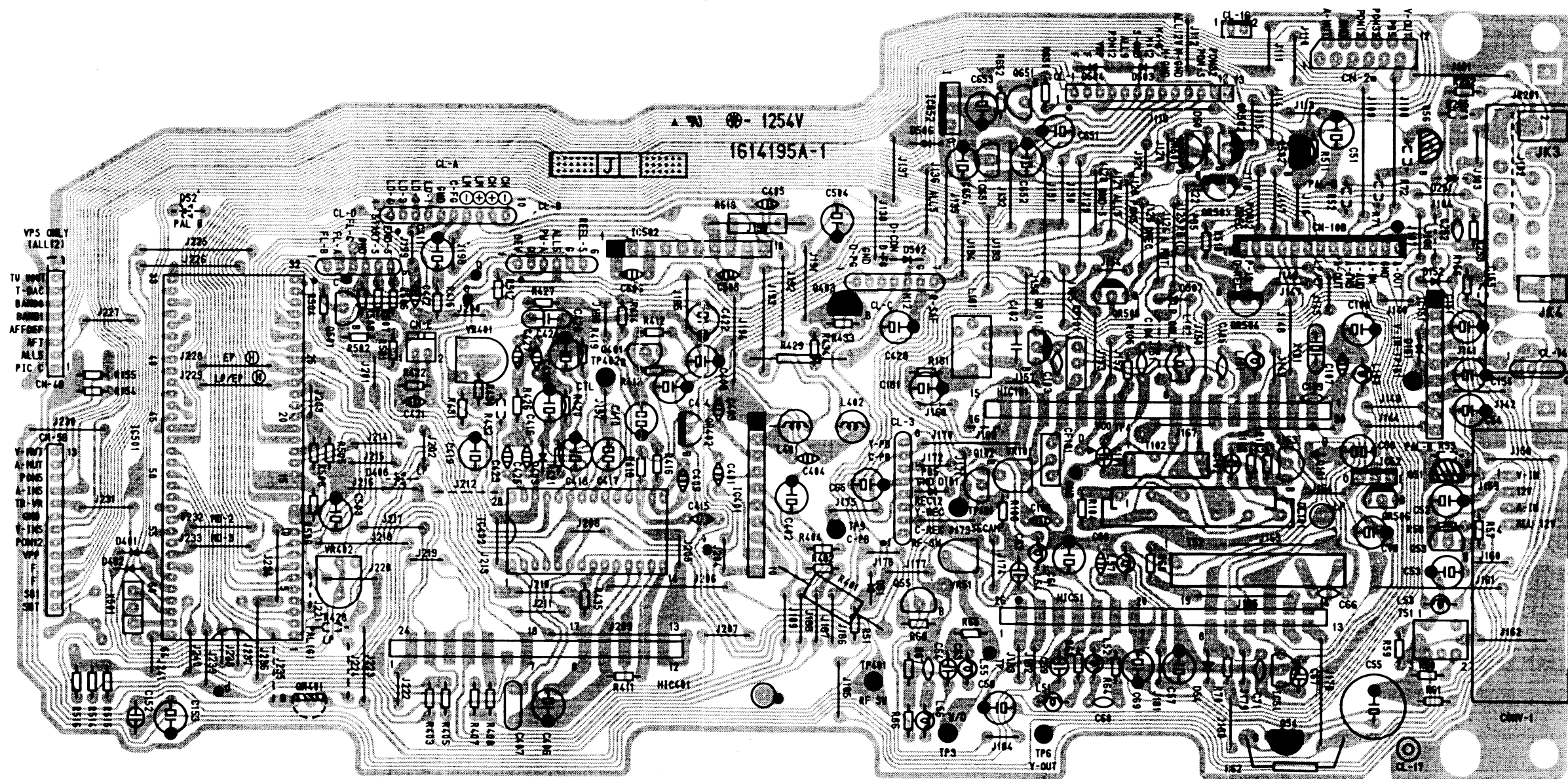

MAIN P.C.BOARD BOTTOM VIEW VCR6000

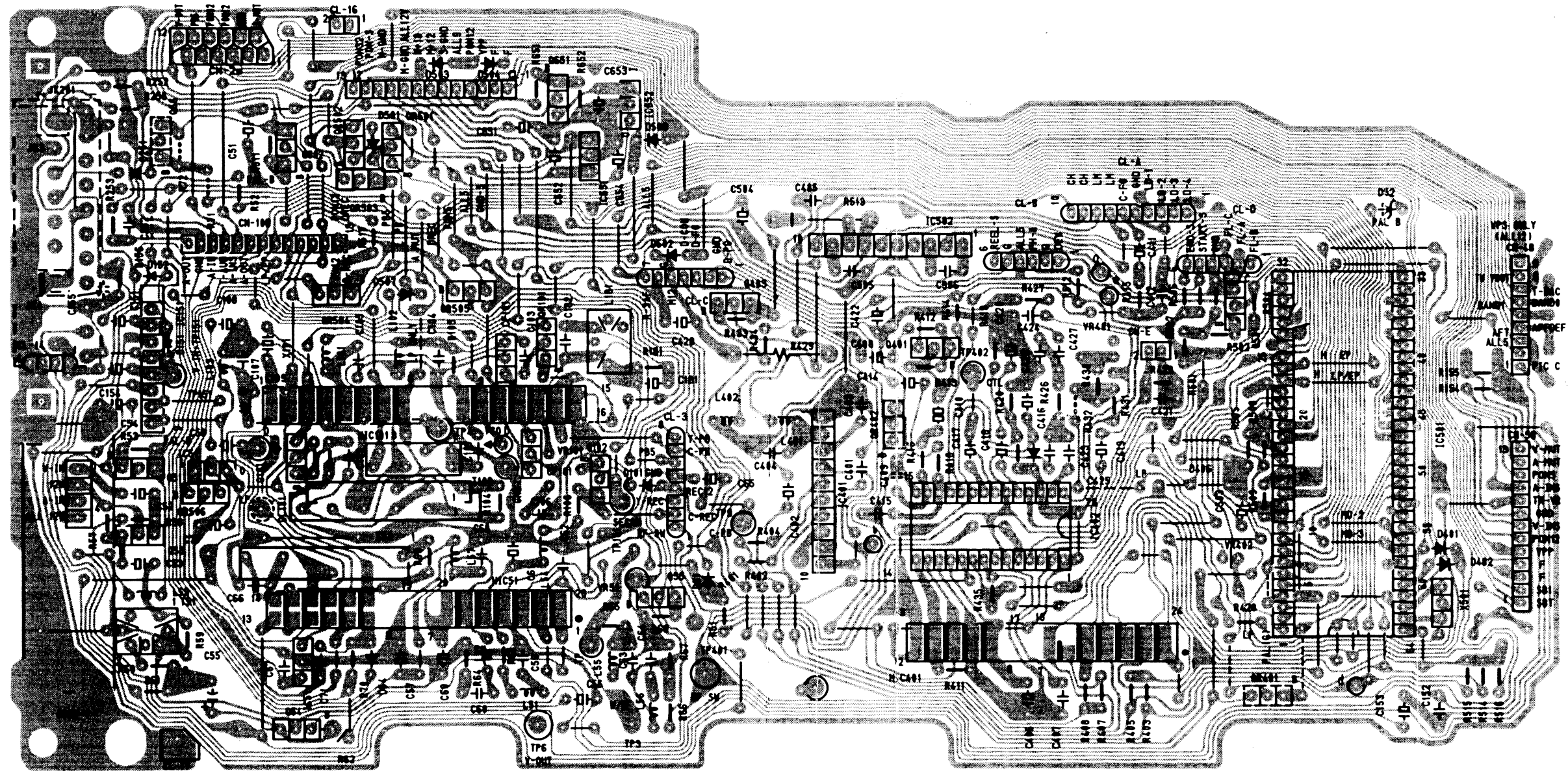

MAIN P.C.BOARD TOP VIEW VCR6100

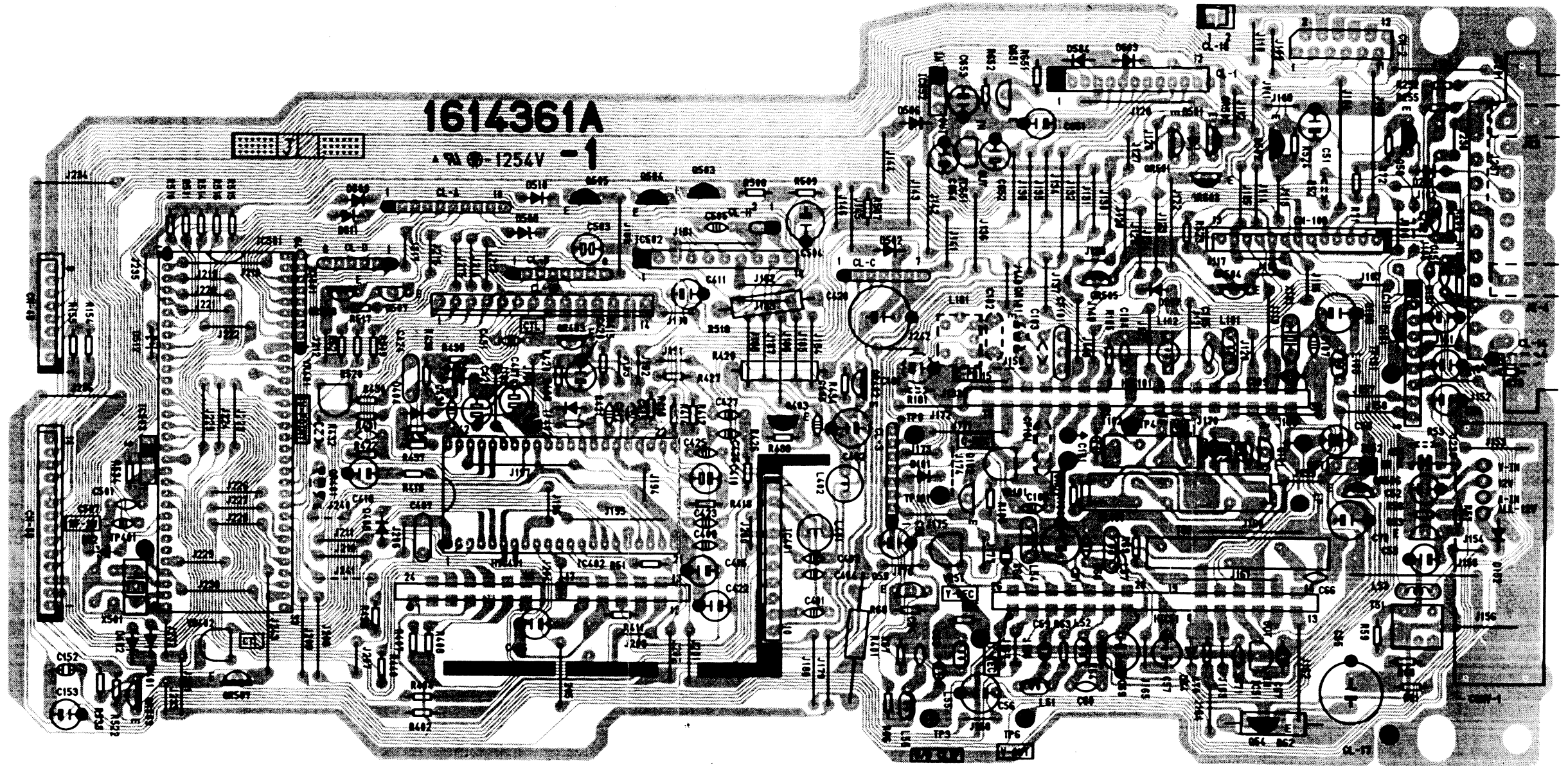

ALL DIAGRAMS ON THIS PAGE REFER TO VCR6000

11-3-1 HEAD AMP P.C.BOARD TOP VIEW

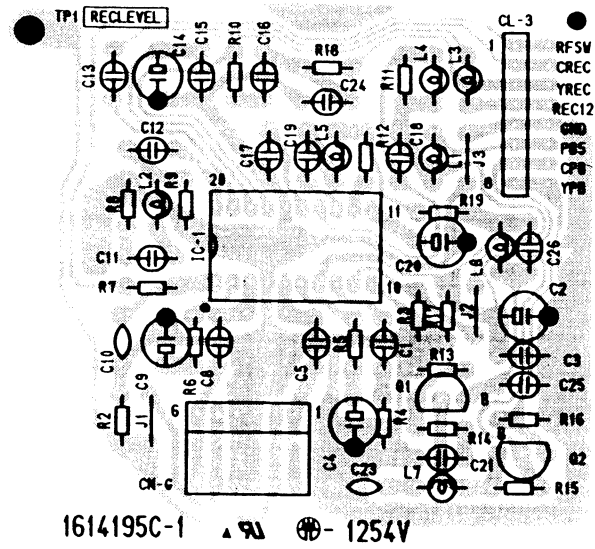

11-3-2 HEAD AMP P.C.BOARD BOTTOM VIEW

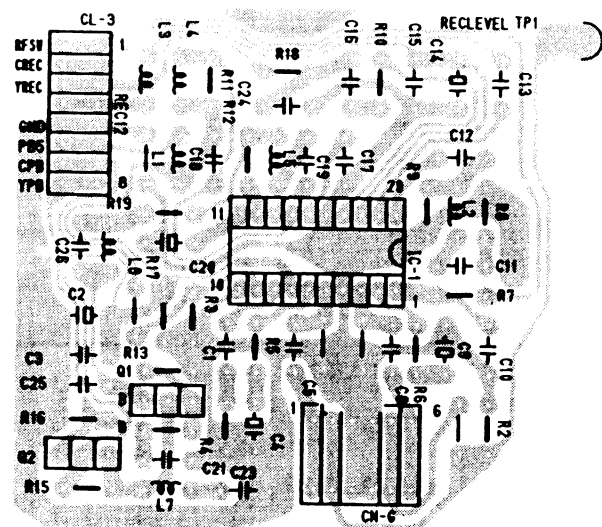

11-2-1 AUDIO P.C.BOARD TOP VIEW

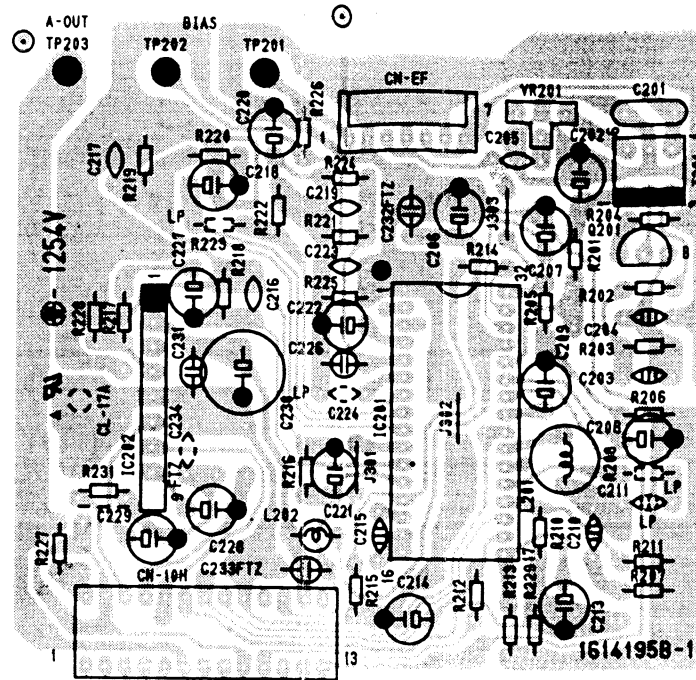

11-2-2 AUDIO P.C.BOARD BOTTOM VIEW

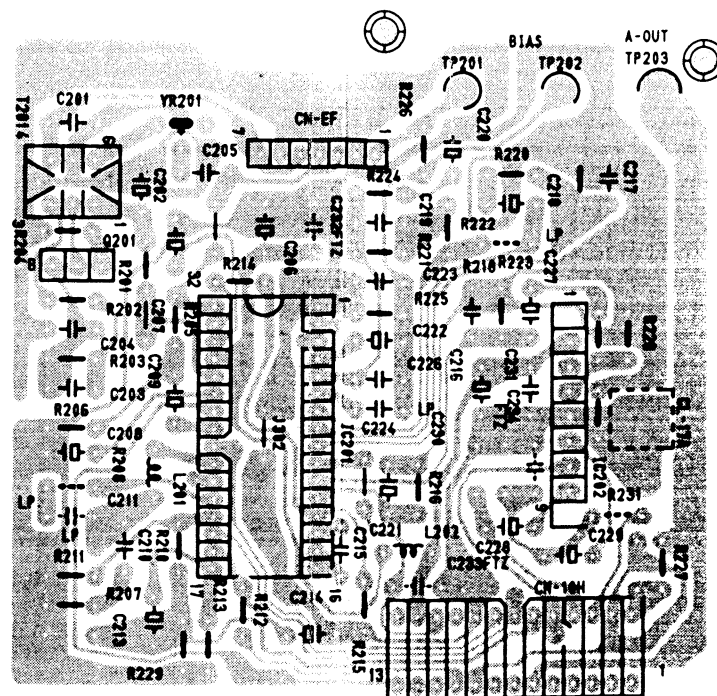

11-4-1 CONNECTOR A
P.C.BOARD TOP VIEW

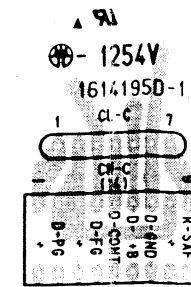

11-4-2 CONNECTOR A
P.C.BOARD BOTTOM VIEW

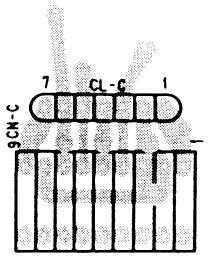

11-5-1 CONNECTOR B
P.C.BOARD TOP VIEW

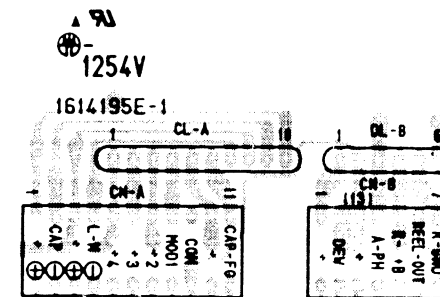

11-5-2 CONNECTOR B
P.C.BOARD BOTTOM VIEW

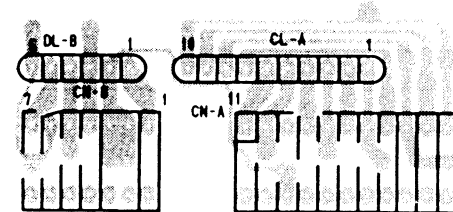

11-6-1 CONNECTOR C
P.C.BOARD TOP VIEW



11-6-2 CONNECTOR C
P.C.BOARD BOTTOM VIEW

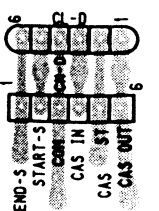

ALL DIAGRAMS ON THIS PAGE REFER TO VCR6100 ONLY

11-2-1 AUDIO P.C.BOARD TOP VIEW

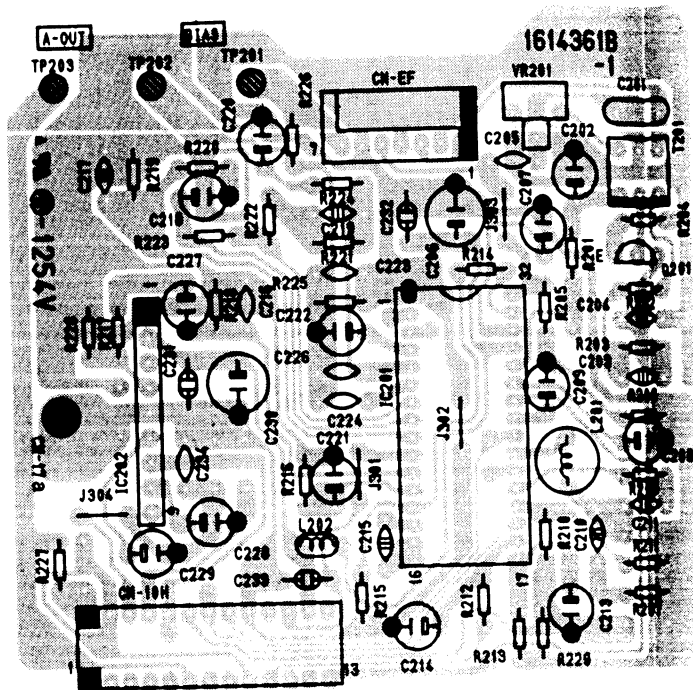

11-2-2 AUDIO P.C.BOARD BOTTOM VIEW

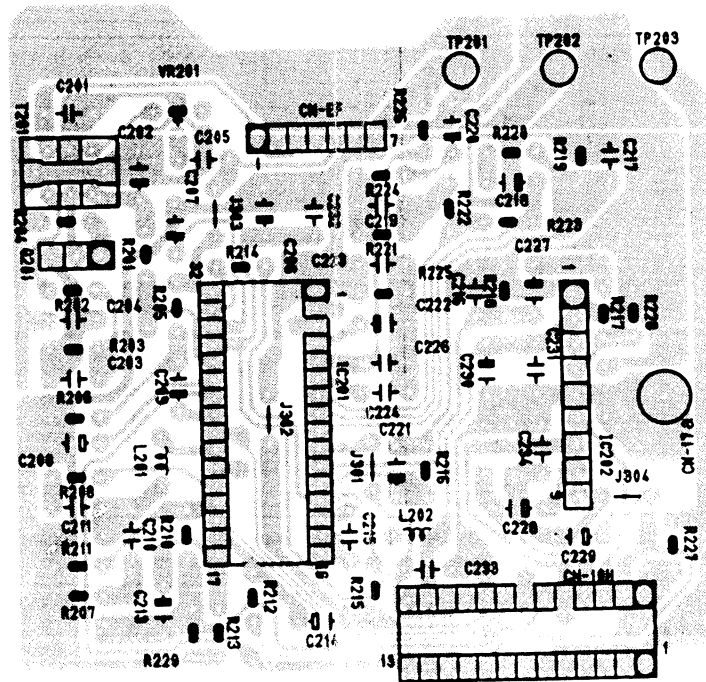

11-12-1 INDEX P.C.BOARD TOP VIEW

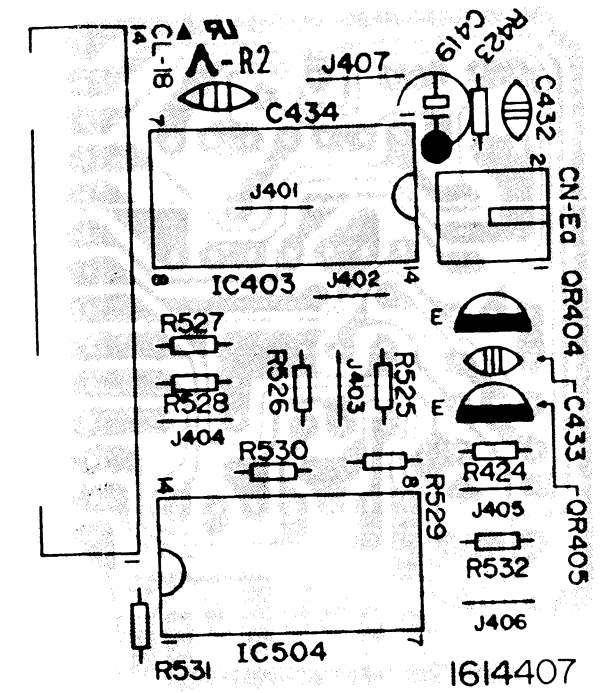

11-3-1 HEAD AMP P.C.BOARD TOP VIEW

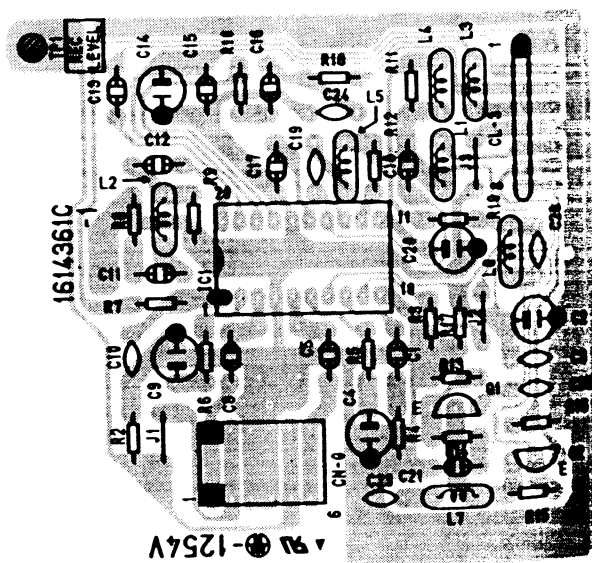

11-3-2 HEAD AMP P.C.BOARD BOTTOM VIEW

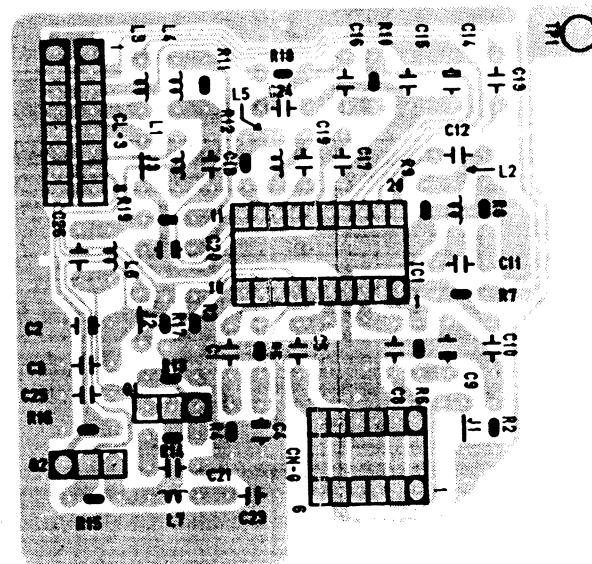

11-12-2 INDEX P.C.BOARD BOTTOM VIEW

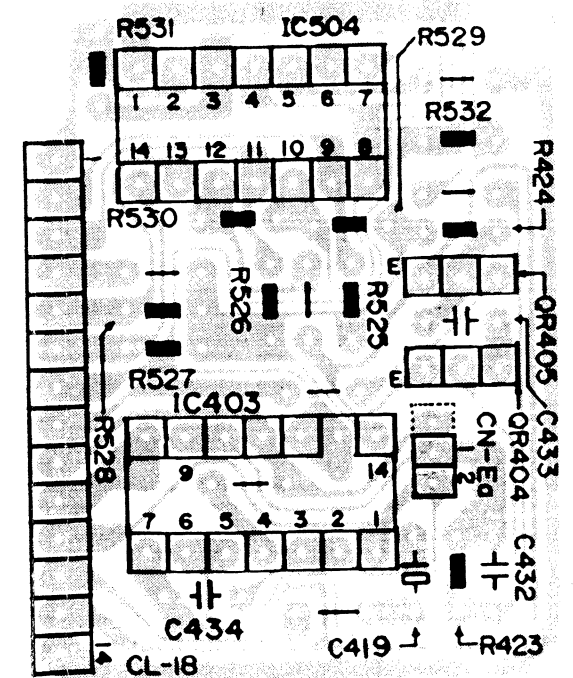

11-4-1 CONNECTOR A
P.C.BOARD TOP VIEW

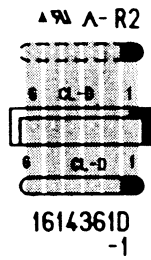

11-4-2 CONNECTOR A
P.C.BOARD BOTTOM VIEW

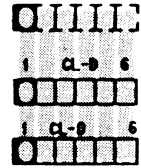

11-6-1 CONNECTOR C
P.C.BOARD TOP VIEW

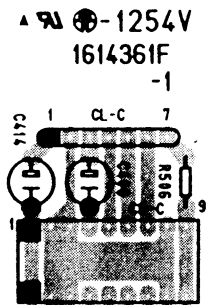

11-6-2 CONNECTOR C
P.C.BOARD BOTTOM VIEW

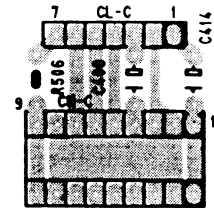

S PAGE REFER TO VCR6100 ONLY

A **11-5-1 CONNECTOR B**
EW **P.C.BOARD TOP VIEW**

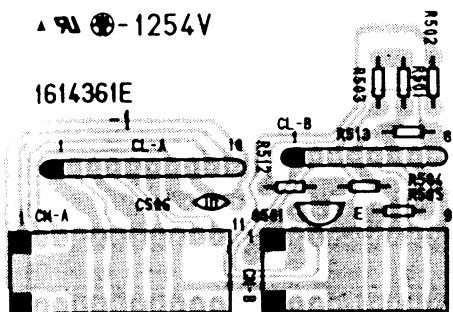

11-5-2 CONNECTOR B
P.C.BOARD BOTTOM VIEW

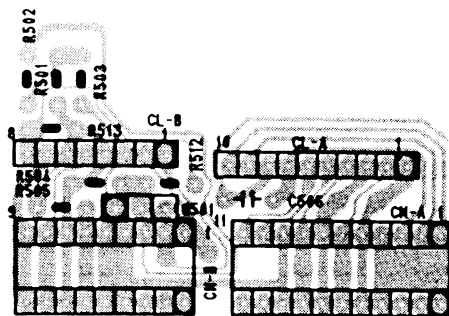

C **11-7-1 CONNECTOR D**
EW **P.C.BOARD TOP VIEW**

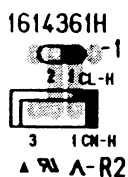

11-7-2 CONNECTOR D
P.C.BOARD BOTTOM VIEW

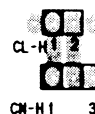

11-9-1 TIMER P.C.BOARD TOP VIEW VCR6100

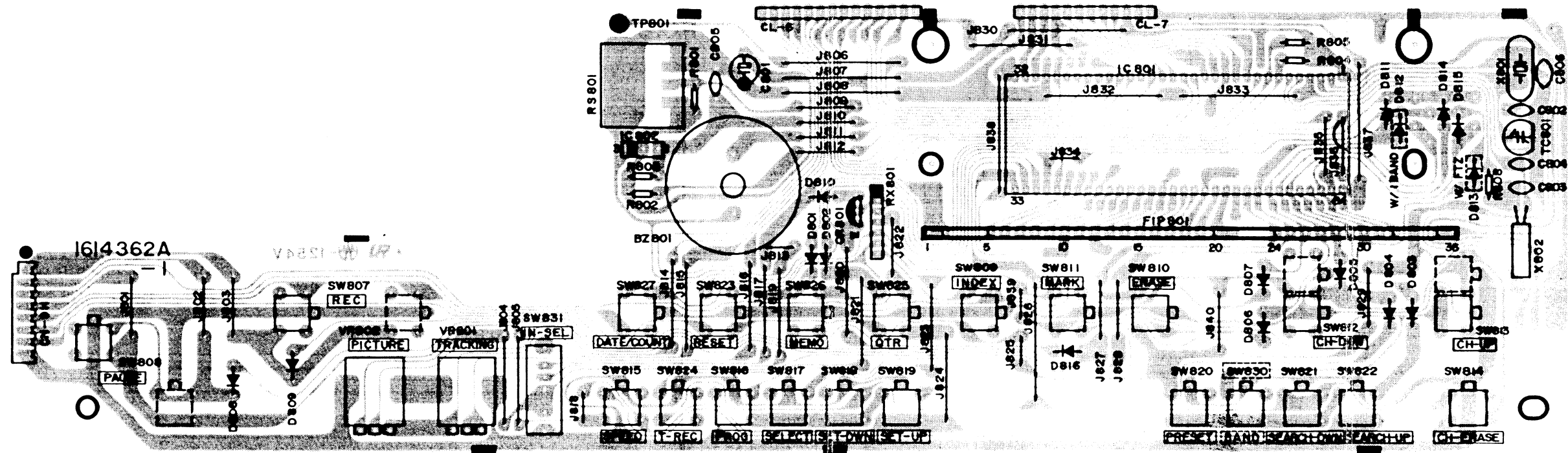

11-8-2 TIMER P.C.BOARD BOTTOM VIEW VCR6100

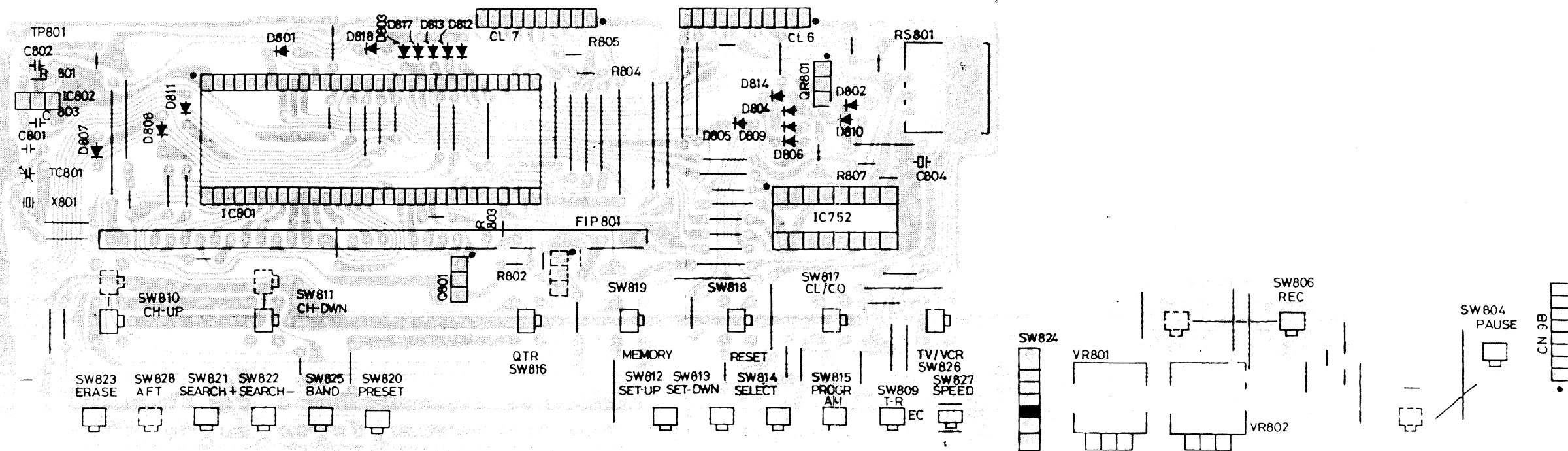

11-9-1 TUNER P.C.BOARD TOP VIEW

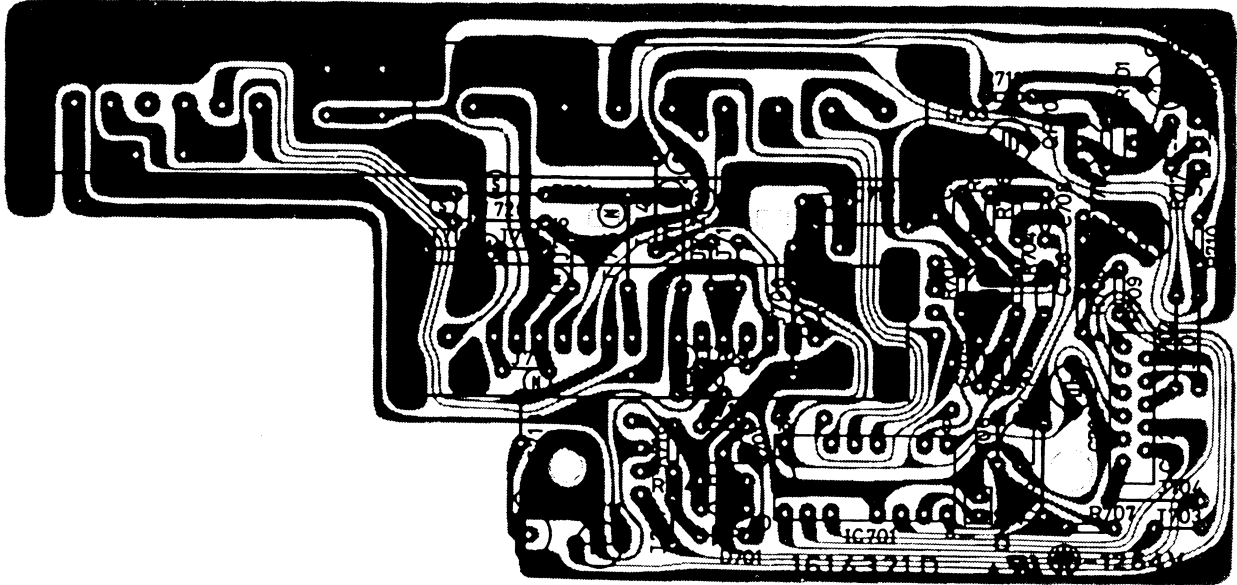

11-10-1 JOINT P.C.BOARD TOP VIEW

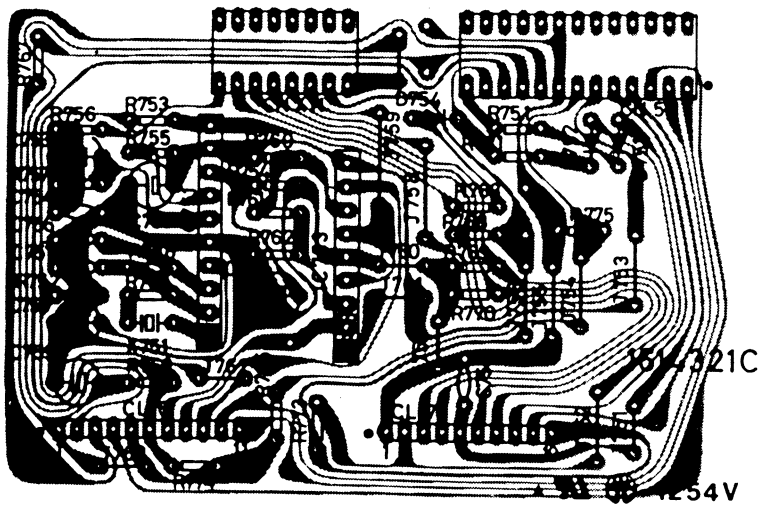

THIS PAGE REFER TO VCR6000 ONLY

11-9-2 TUNER P.C.BOARD BOTTOM VIEW

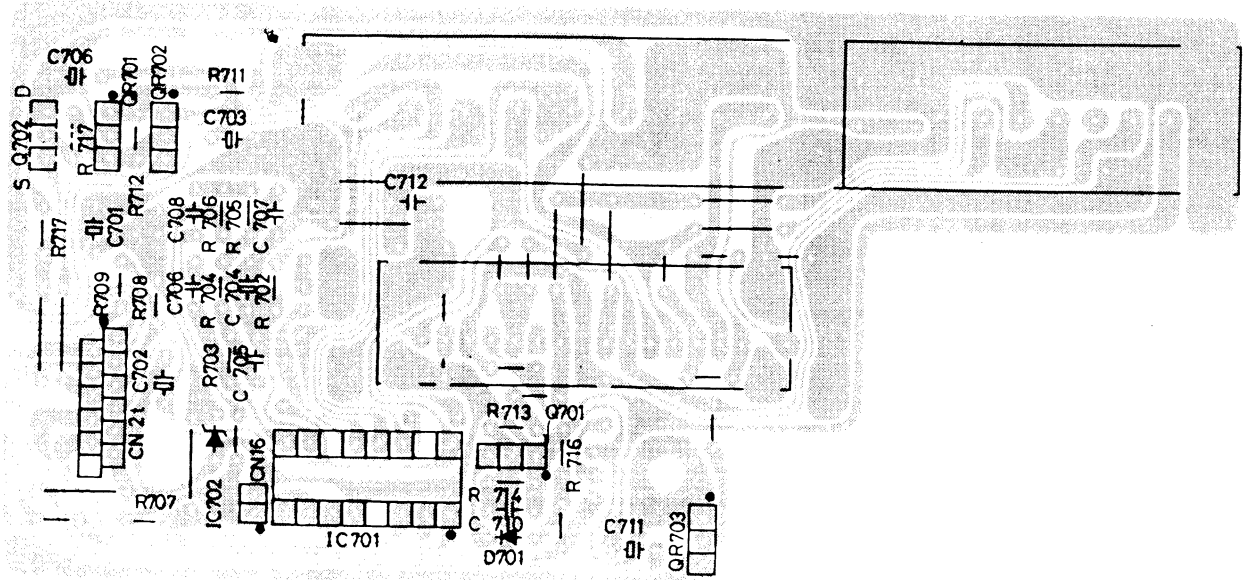

11-10-2 JOINT P.C.BOARD BOTTOM VIEW

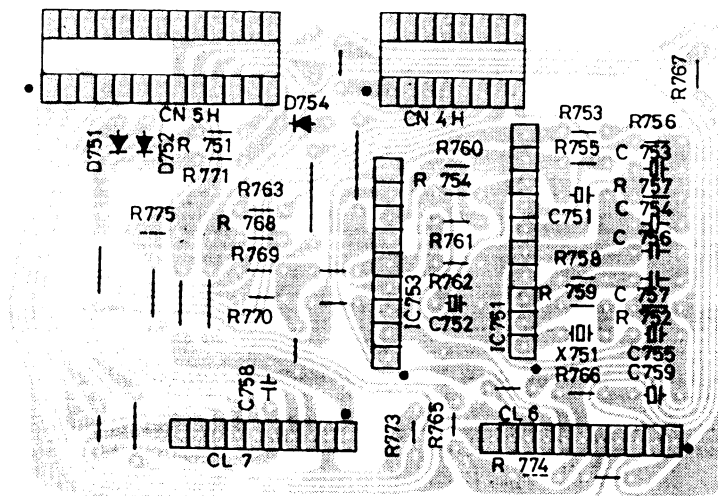

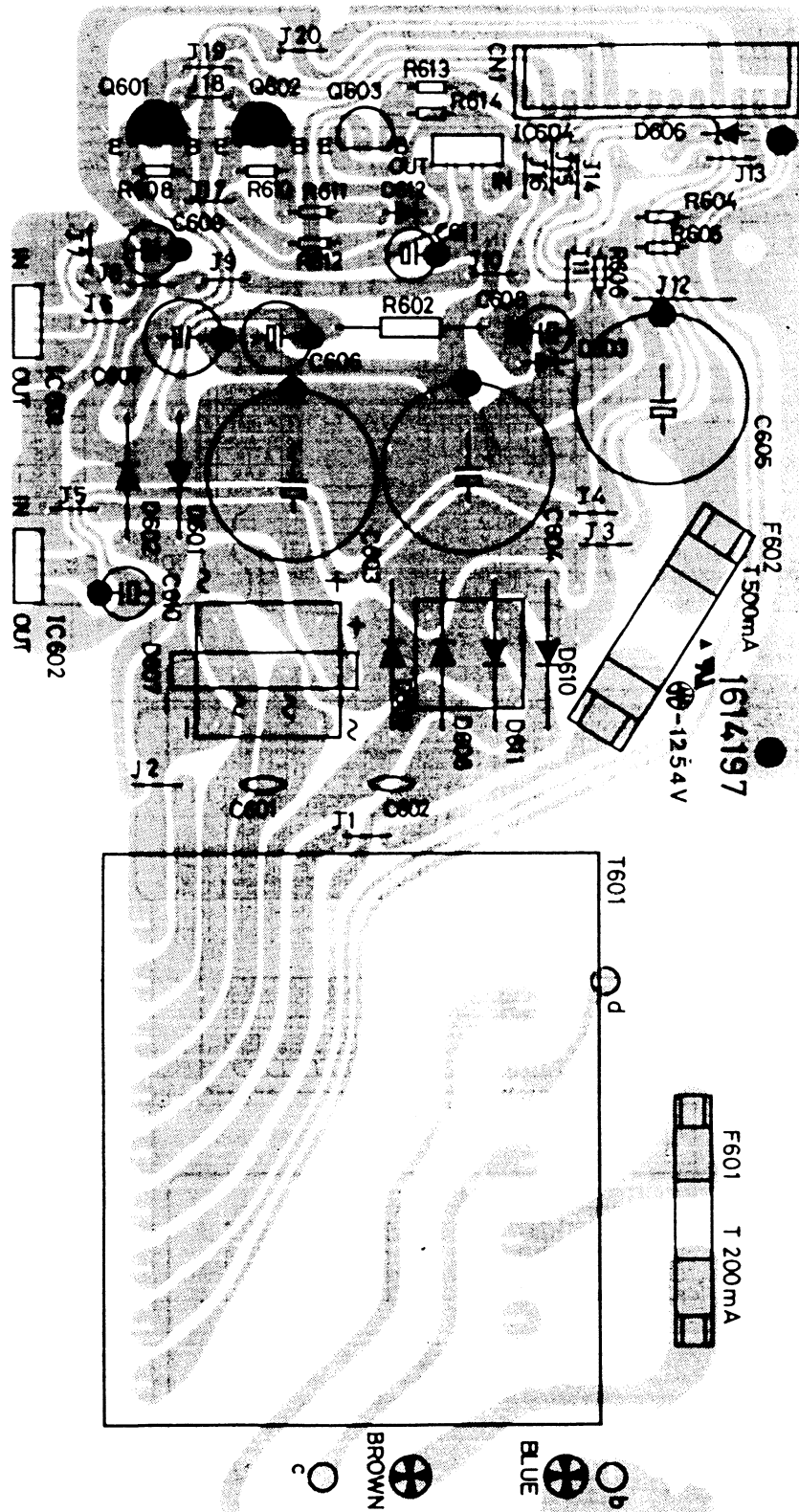

11-11-2 POWER SUPPLY P.C.BOARD BOTTOM VIEW VCR6000/6100

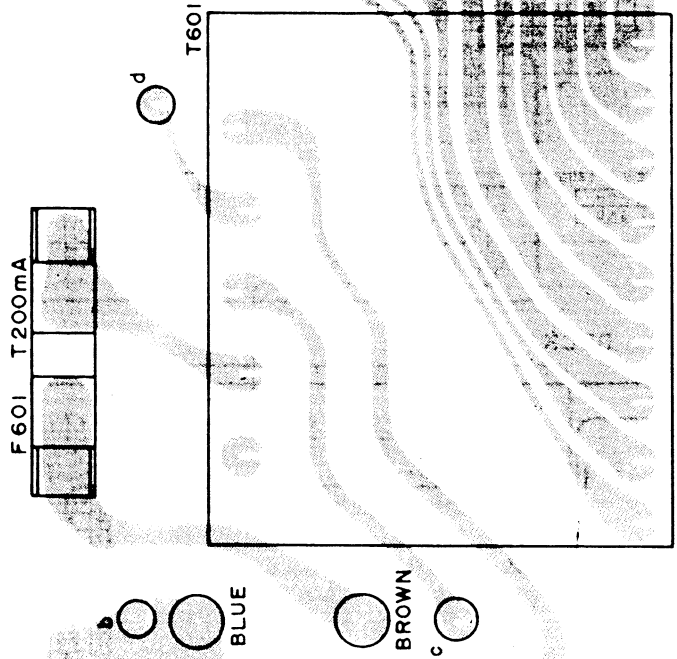
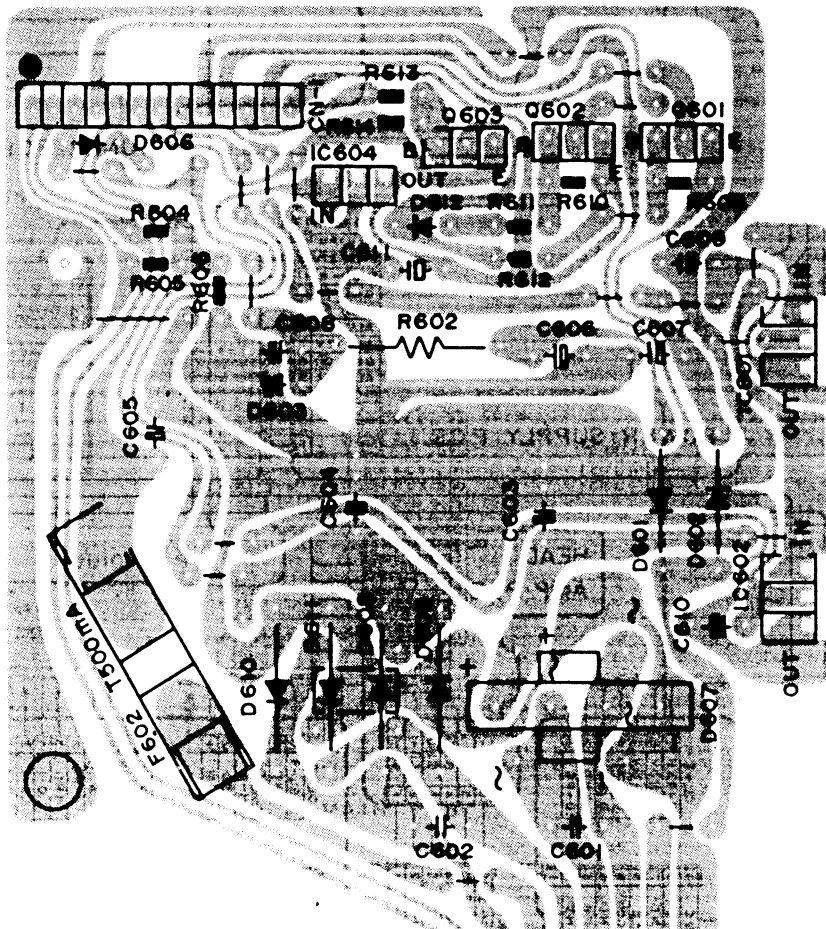

12. WIRING DIAGRAM VCR6100

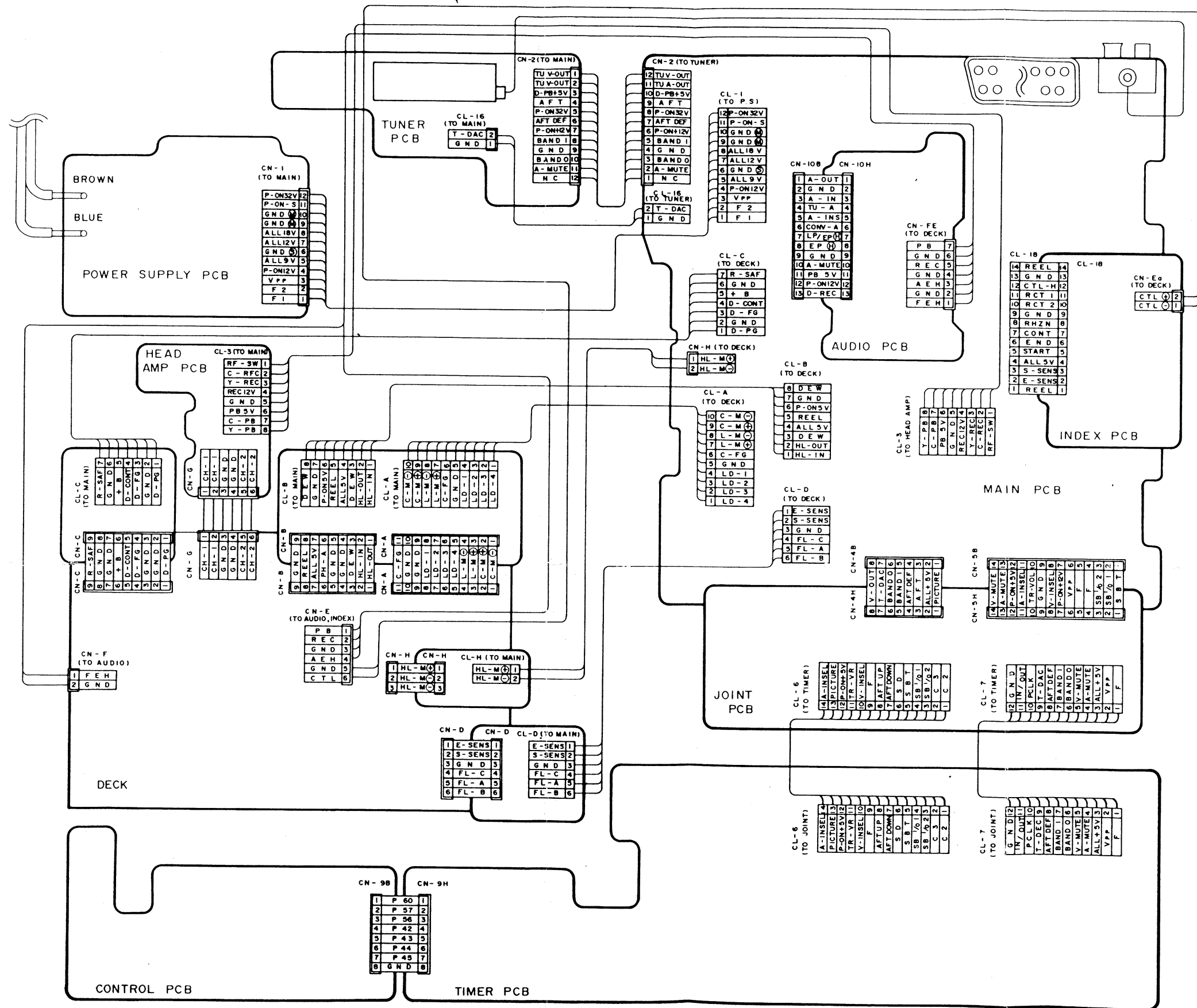

VCR6100 SYSTEM CONTROL TIMING CHARTS

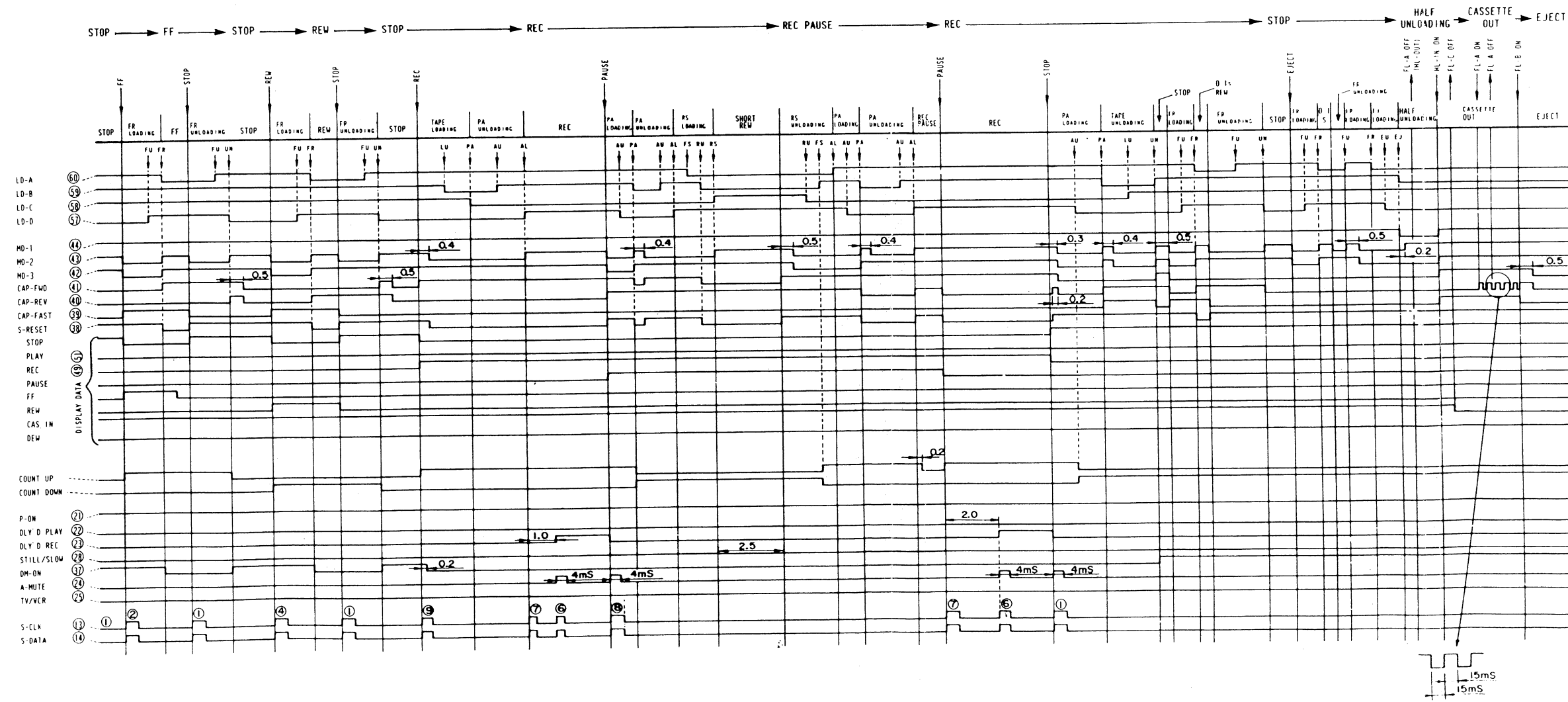
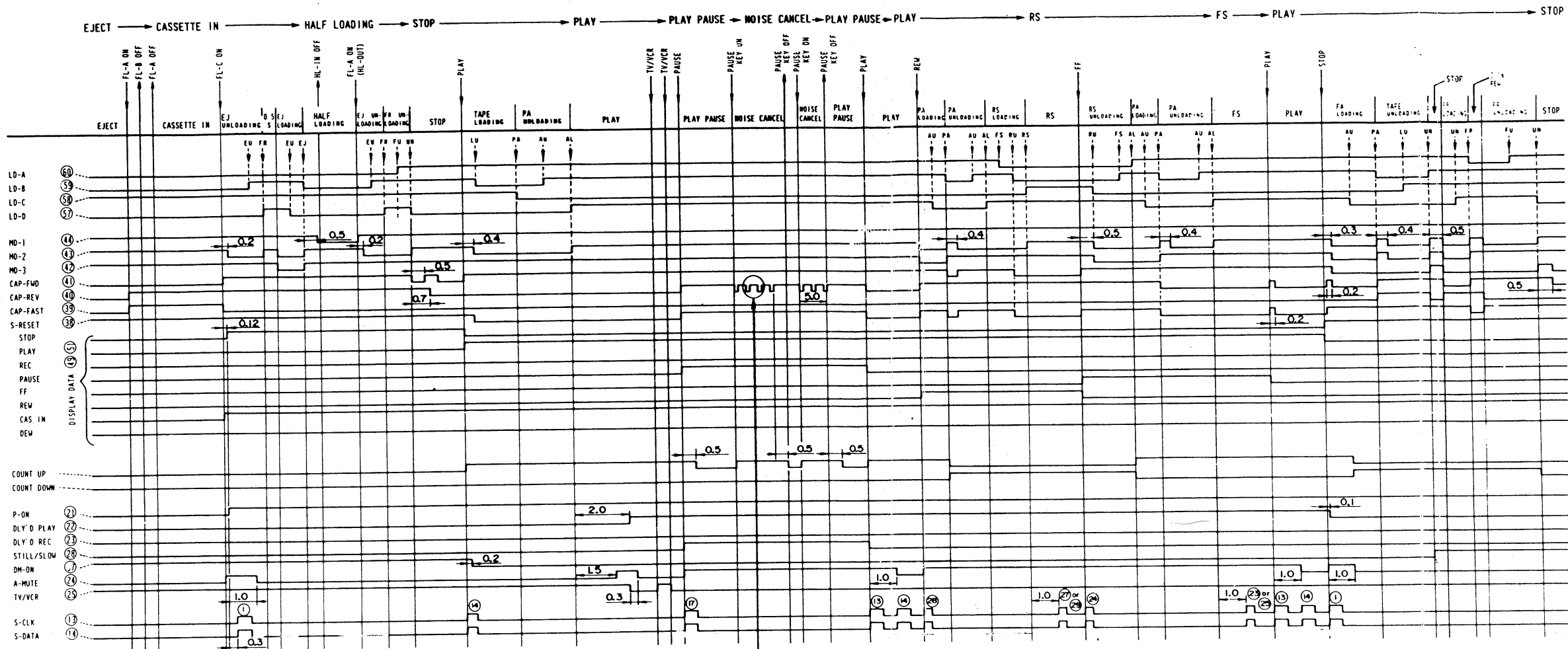

VCR6100 SYSTEM CONTROL TIMING CHART

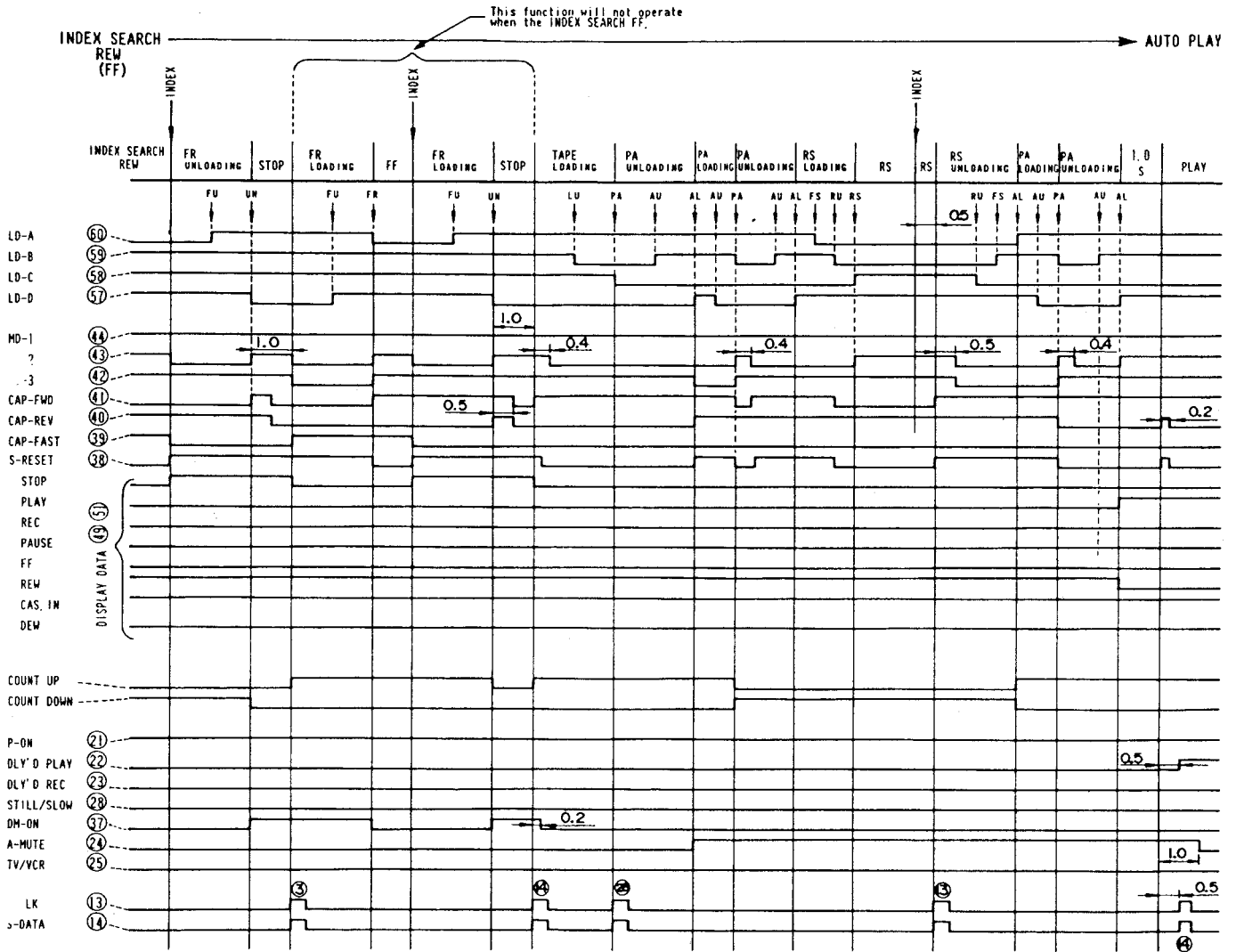

LEAD IDENTIFICATIONS VCR6000

AN78L05
MJM78L05A

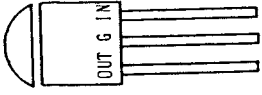

2SA934
2SB1010
2SD1384
2SB892
2SD1207
2SC2060
2SD400

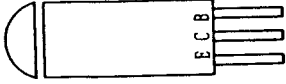

2SC2808
2SC2058
2SA1038
2SA1016K

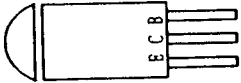

AN7812F
MJM7812FA
AN7818F
AN78M05
μPCT7818HF

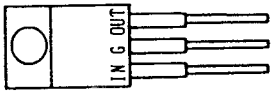

L5631
μPCS74J

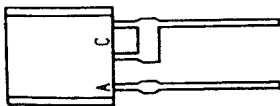

A: Anode
C: Cathode

DTA124
DTC124
DTA143XS
DTA114VS
2SC3400
2SA1346

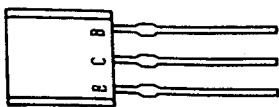

2SA933
2SC1740
2SA608SP
2SA1317
2SC336SP
2SC2839
2SD1466SR
2SD1012

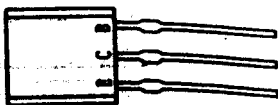

AN3331K

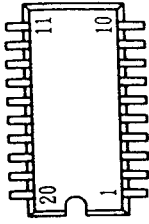

MJM2233S

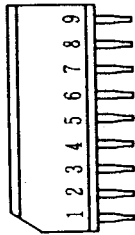

LA7913
HM1225

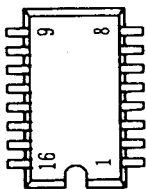

HM1280Q

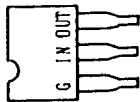

2SK128TAP0
2SK304

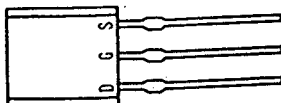

14DM363

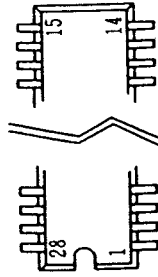

LA7210

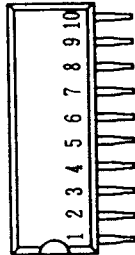

AM6913
BA7021
MJM2903S
BA6933M

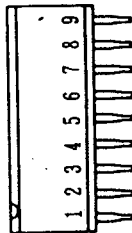

14DM348
14DM332A

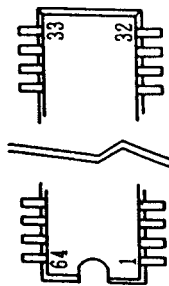

BA7767S
BA7767AS

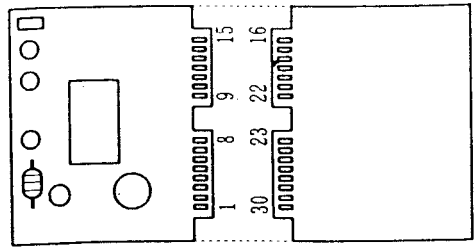
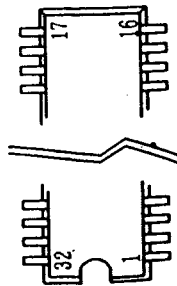

1812421
(VIDEO-C)
HIC 101

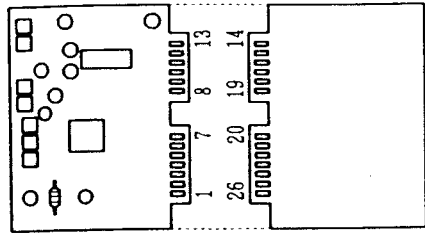

1812119
(VIDEO-Y)
HIC 51

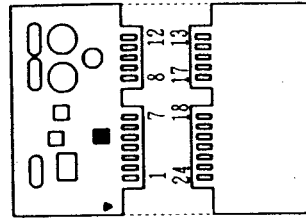

1812455
(SERVO)
HIC 401

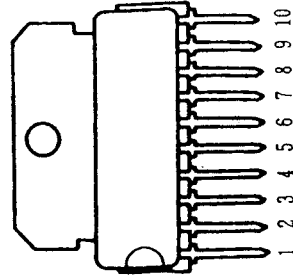

BA6219B
BA6209

MECHANICAL ASSEMBLY EXPLODED ' (PLEASE NOTE: ALL PARTS WITH PREI

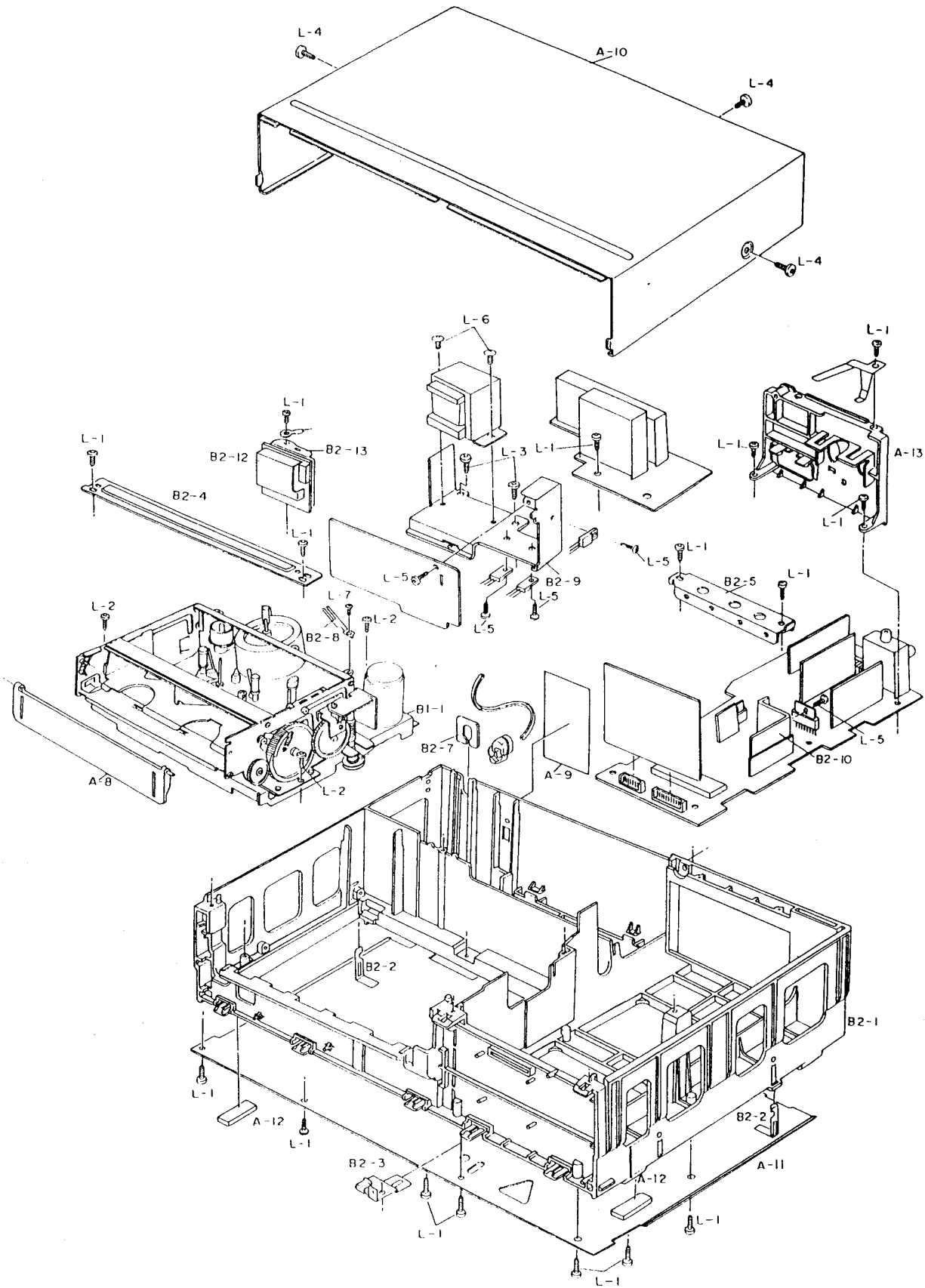

**ODED VIEWS AND PARTS LISTS
H PREFIX * REFER TO VCR6100)**

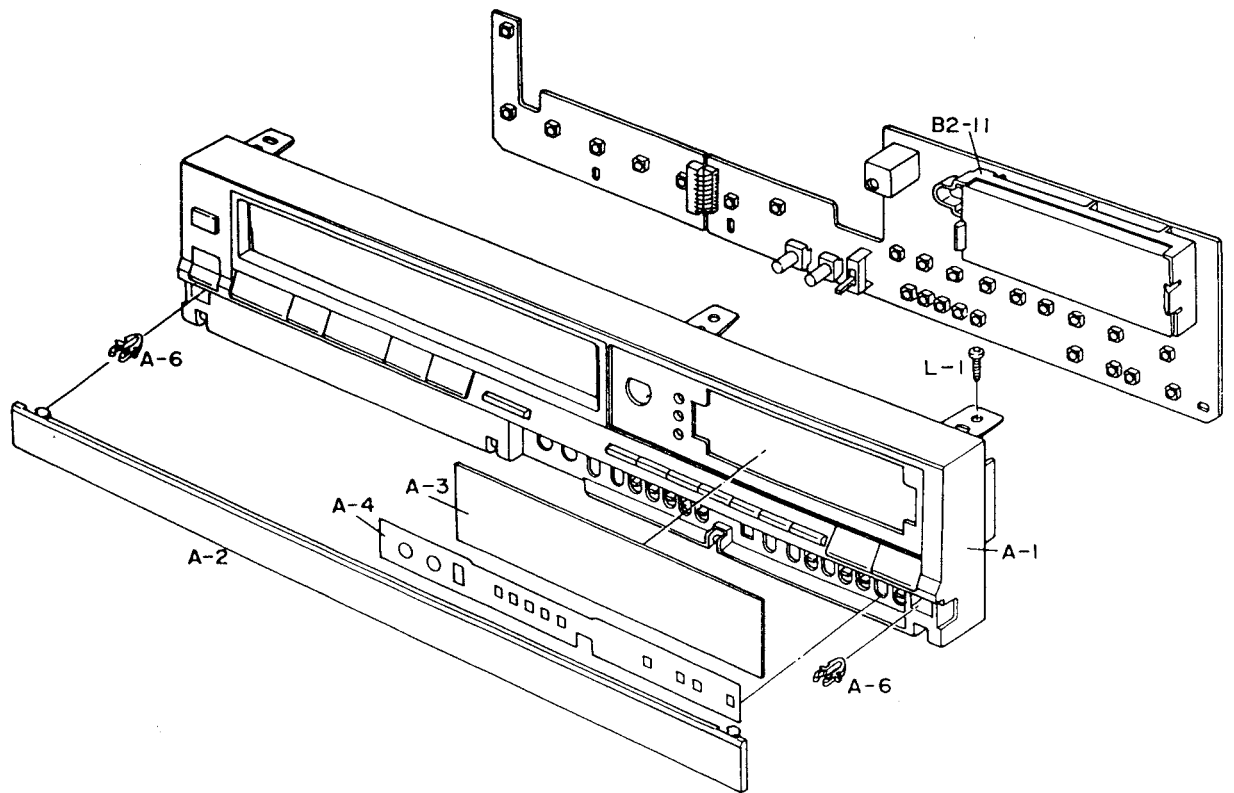

FRONT PANEL ASSEMBLY PARTS LIST

Ref. No.	Description	Part No.
A-1X	Front Panel Assembly VCR6000	153049
A-1X*	Front Panel Assembly VCR6100	153312
A-2	Door Timer VCR6000	153050
A-2*	Door Timer VCR6100	153313
A-6	Latch	153031
A-10	Cabinet Top	153052
A-11	Panel Bottom	153053
A-12	Foot	151455
	Jack Board	153054
	Label Warning	153055
B2-1	Cabinet Main	153057
	Ground Plate Main	153058
	Ground Plate PCB	153059
	Holder Deck Angle	152015
	Holder Supporter	153060
	Plate Ground (RF Converter)	153061

**MECHANICAL EXPLODED VIEW
(PLEASE NOTE: ALL PARTS)**

Ref. No.	Description	Part No.
1	Cylinder Assembly	153062
2	Drum Upper	153063
3	Drum Assembly Lower	153064
4	Mount Cylinder	153065
5	PCB Assembly Video Out	153066
6, 9	Screw, W Sems, M2.6 x 6	
7	Motor TM82	153067
8	Screw, Sems, M2.6 x 20	
10	Screw, Bind Sems, M3 x 8	
12	Screw, Camera, M2 x 5	
13	Screw, Cap, M2.6 x 3	
14	Ground Drum	153068
15, 18	Screw, C Tapping, M2.6 x 5	
16	Bracket Drum Ground	153069
17	P.C.B. Assembly DM	153070
20	Washer, Tooth Lock, M2.6	
51	Loading Base	153071
52	Block (L) Loading	153072
53	Block (R) Loading	153073
54	SIS, Roller Post	150724
55	SI Roller Post	153314
56	Screw, Cup, M2.6 x 3	
57	Screw, Set, M2.0 x 3	
58	Screw, S Tapping, M2.6 x 5	
59	Plate (L) Loading	153074
60	Boss Loading	153075
61	Spring (L) Loading Gear	153076
62	Gear (L) T Loading	153047
63	Plate (R) Loading	153077
64	Spring (R) Loading Gear	153078
65	Gear (R) T Loading	153079
66	Washer, Polyslider, $\phi 2.6 \times \phi 6 \times 10.5$	
198	Spring, Back Tension	153080
205	Plate BT Actuate	153081
206	Lever BT Actuate	153082
207	Collar BT Actuate Plate	153083
209	Collar	153084
210	Screw, S Tapping Camera, 2.6 x 3.5	
211	Screw, S Tapping 2.6 x 5	
341	Switch Leaf	153085
342	Screw, S Tapping, M2.6 x 5	
343	Wire	
344	Holder Wire	
345	Lamp Holder Assembly	153086
345*	Lamp Holder Assembly	

**VIEWS AND PARTS LIST VCR6000/6100
(S WITH PREFIX * REFER TO VCR6100)**

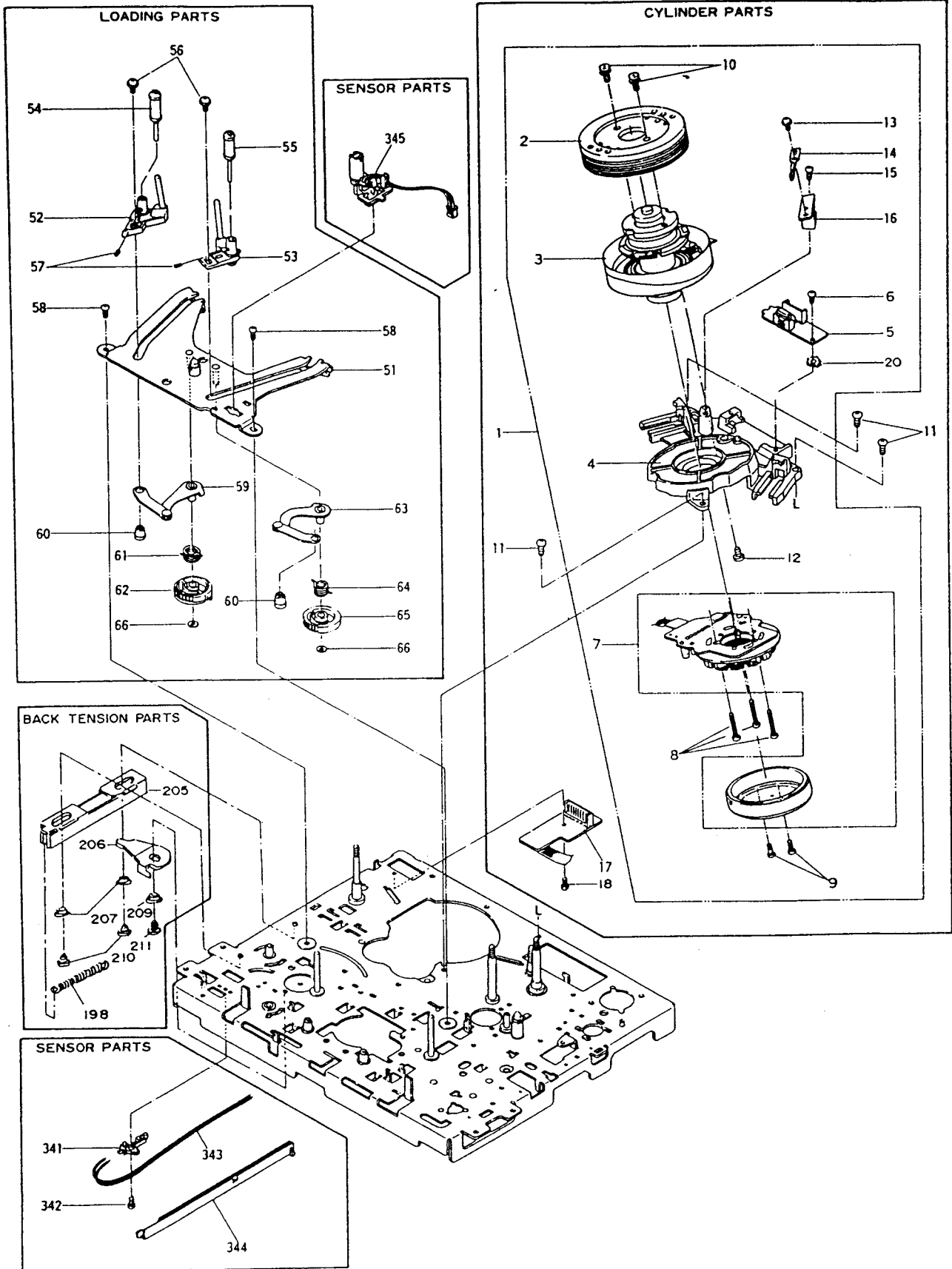

Please note: Reference numbers with * prefix are for m

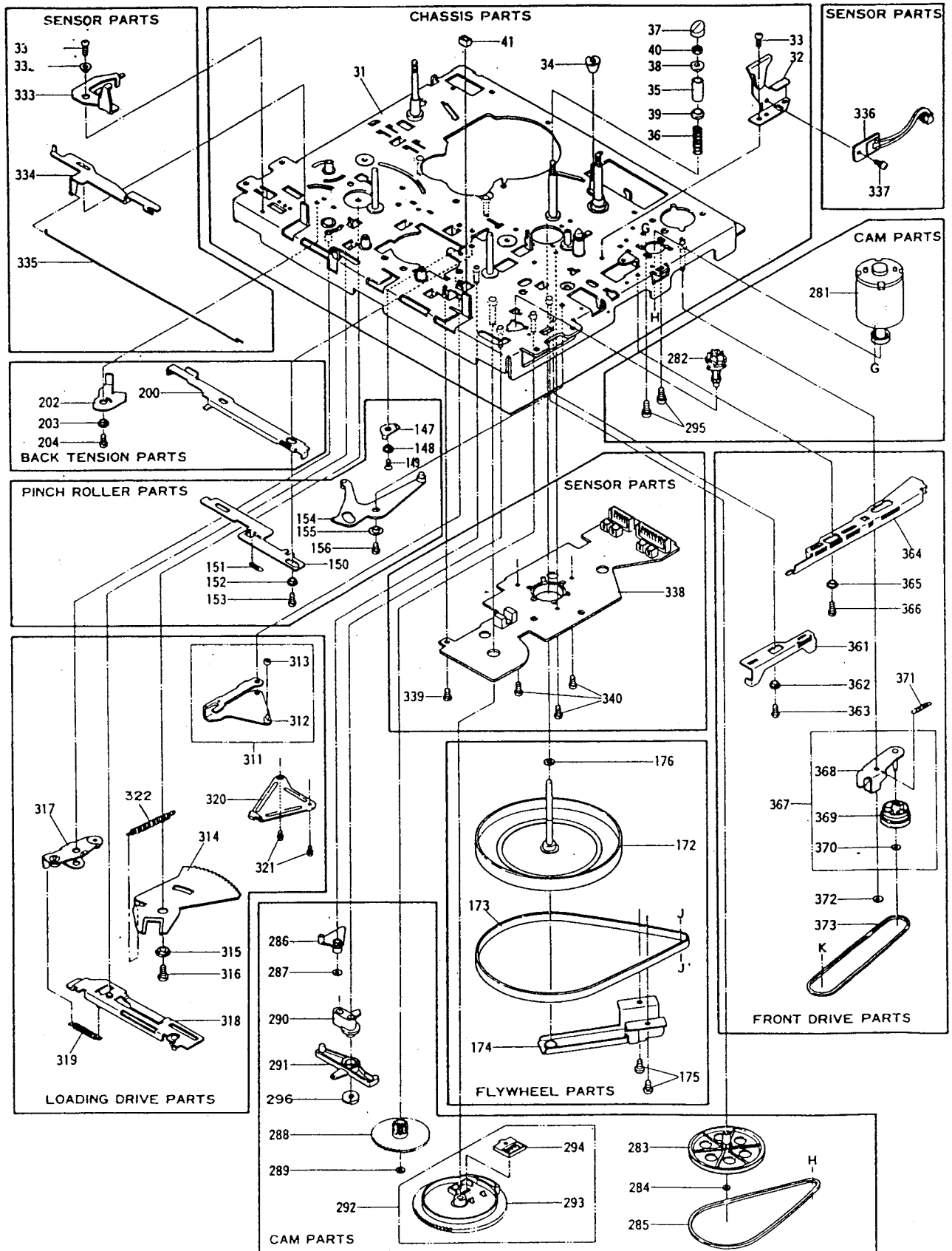

Ref.	Description	Part No.
81	Head Base Assembly	153133
82	Head Ace	153134
83	Base Head	153135
83*	Base Head	
84	Screw Azimuth Spring	
85	Spring Azimuth	151268
86, 95	Nut, Nylon, M3	150754
87	Collar, Adjust	153255
88	Screw, Pan Head, M2.6 x 7	
89	Screw, Set, M3 x 5	
90	Spring Head	153136
90*	Spring Head	153256
91	Plate Assembly Full Erase	153137
92	Head Full Erase	150759
93	Plate Full Erase	153138
94	Screw, Flange Bind, M2 x 3	
96	Roller Impedance	153139
97	Sleeve Impedance Roller	153140
98	Flange (A) Tape Guide	153141
99	Spring Tape Guide Flange	153142
100	Washer, Plain, $\phi 3 \times \phi 8 \times t0.5$	
101	Spring FE Plate	153143
102	Plate FE Slide	153144
103	Spring FE Actuate	153145
104	Lever FE Actuate	153146
105	Washer, Polyslider, $\phi 2.1 \times \phi 5 \times t0.5$	
121	Reel Assembly	153147
122	Washer, $\phi 3.1 \times \phi 6 \times t0.5$	
131	Arm Assembly Pinch Roller	153148
132	Arm Pinch Roller	153149
133	Screw, Pan Head, M2.6 x 4	
134	Roller (A) Pinch	150768
135	Washer, Polyslider, $\phi 5 \times \phi 8 \times t0.5$	
136	Screw, Sems, M2.6 x 4	
137	Collar	153084
138	Angle P Actuate	153150
139	Holder P Angle	153151
140	Spring P Roller	153152
141	Plate (A) P Slide	153153
142	Collar	
143	Screw, S Tapping, M2.6 x 5	
144	Joint Plate	153154
145	Arm P Actuate	153155
146	Spring P Actuate Arm	153156
157	Plate (B) P Slide	153157
171	Motor Assembly Capstan	153158
177	Housing Assembly Metal	153159
178	Screw, S Tapping, M2.6 x 8	
179	Screw, Sems, M3 x 4	
191	Arm Back Tension	153160
192, 194	Screw, S Tapping, M2.6 x 4	
193	Support Back Tension	153161
195	Collar Band Holder	153162
196	Band BT	153163
197	Spring Band Holder	153164
199	Washer, Polyslider, $\phi 2.1 \times \phi 4 \times t0.5$	
208	Spring BT Actuate Plate	153165

Ref.	Description	Part No.
221	Plate Assembly	153196
222	Plate Semi Assembly	153197
223	Screw, Sems, M2 x 4	
224	Screw, S Tapping, M2.6 x 4	
225	Washer Wave	
226	Gear Reel Drive	153198
227	E Ring S 1.5	150734
263	Brake Take-Up Soft	153199
265	Screw, Camera, M2 x 3	
266	Collar Take-Up Soft Brake Arm	153200
266*	Collar Take-Up Soft Brake Arm	153218
268	Spring Take-Up Soft Brake Arm	153201
228	Washer, Nylon, $\phi 3.1 \times \phi 6 \times t0.3$	
229	Clutch Assembly	153202
230	Washer, Nylon, $\phi 2.98 \times \phi 6 \times t0.3$	
231	Pulley Assembly Middle	153203
232	Washer, Polyslider, $\phi 2.6 \times \phi 6 \times t0.5$	
233	Belt Drive	153204
239	Gear Assembly P	153205
234	Arm Assembly P Gear	153206
235	Gear Play	153207
238	Washer, Polyslider, $\phi 1.6 \times \phi 3.8 \times t0.3$	
240	Gear Assembly RF	153208
236	Arm Assembly RF Gear	153209
237	Gear FF	153210
253	Spring Brake Arm	153211
255	Arm Assembly S Brake	153212
251	Shoe Brake	153213
252	Arm S Brake	153214
256	Arm Assembly T Brake	153215
256*	Arm Assembly T Brake	153251
254	Arm T Brake	153216
254*	Arm T Brake	153252
257	Lifter Brake	153217
257*	Lifter Brake	153201
258	Actuator L Brake	153218
259	Hook Trigger	153219
260	Lever Trigger	153220
261	Plate Brake	153221
262	Brake Actuator Base	153222
264	Brake S Soft	153223
267	Spring L Brake Actuator	153224
269	Spring S Soft Brake	153225
270	Washer, Polyslider, $\phi 2.1 \times \phi 5 \times t0.5$	
271	Spring Trigger Lever	153226
272	Arm, Brake Actuator	153253
531	Plate RG Slide	153227
532	Spring RG Slide	153228
533	Collar RG Slide Plate	153229
534	Screw, Sems, M2 x 4	
535	Base RG Slide	153230
536	Arm Semi Assembly RG	153231
537	Washer, Polyslider, $\phi 2.6 \times \phi 6 \times t0.5$	
538	Arm, RG Actuate	153232
538*	Arm RG Actuate	153232
539	Washer, Polyslider, $\phi 2.1 \times \phi 5 \times t0.5$	
540	RG Actuator	153233

with * prefix are for model VCR6100 only.

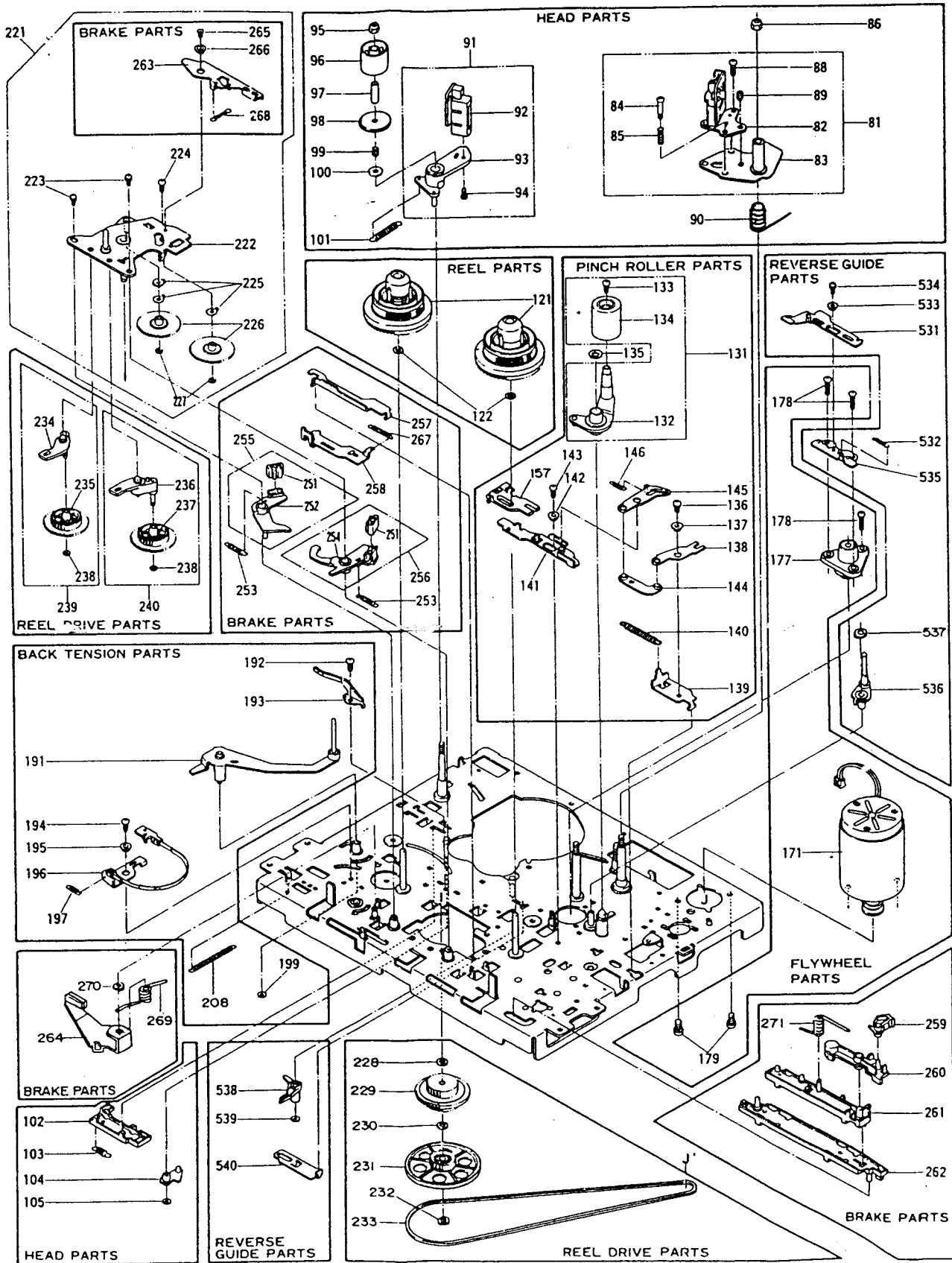

please Note: Reference numbers with * prefix are for model

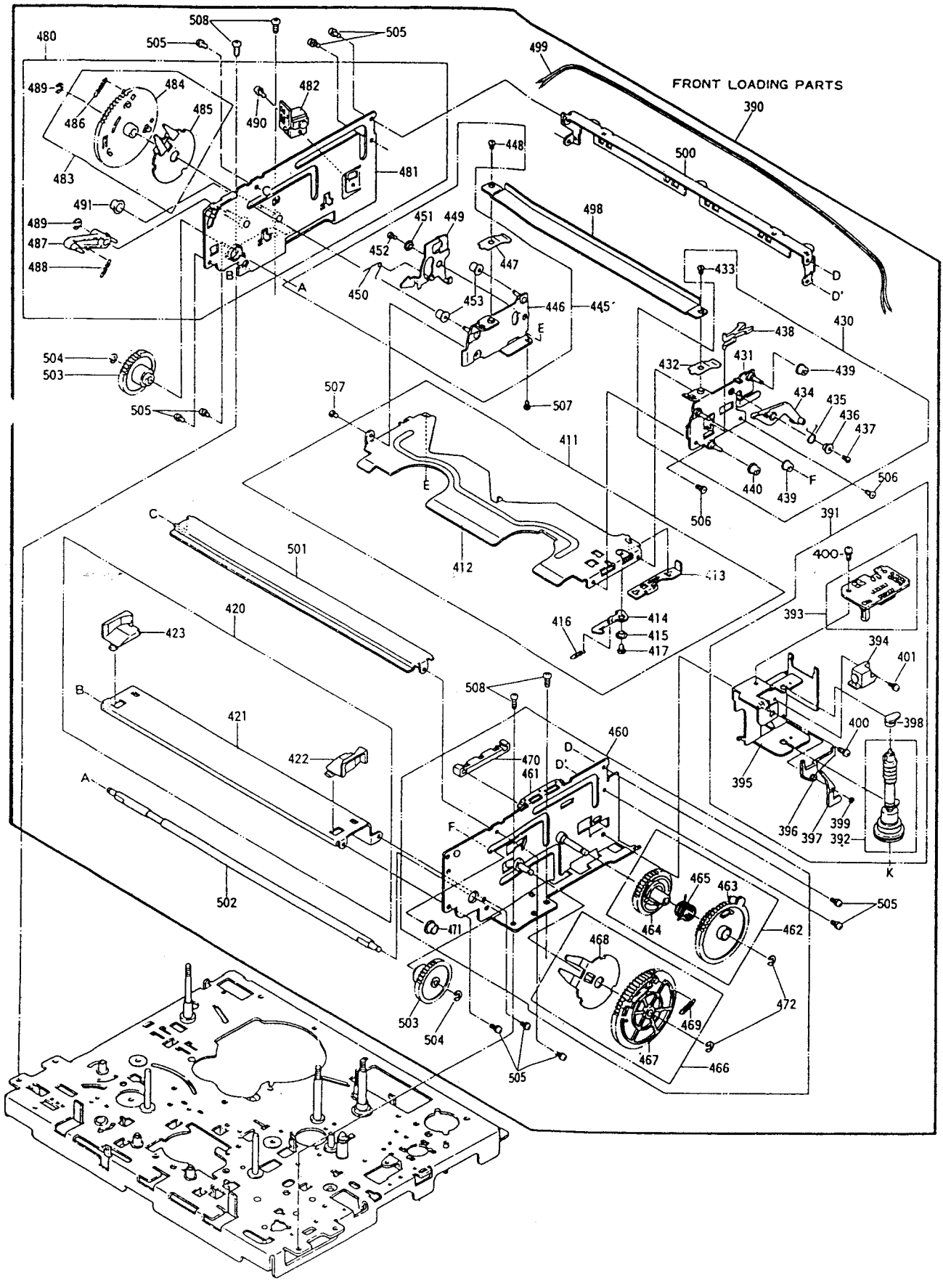

are for model VCR6100 only.

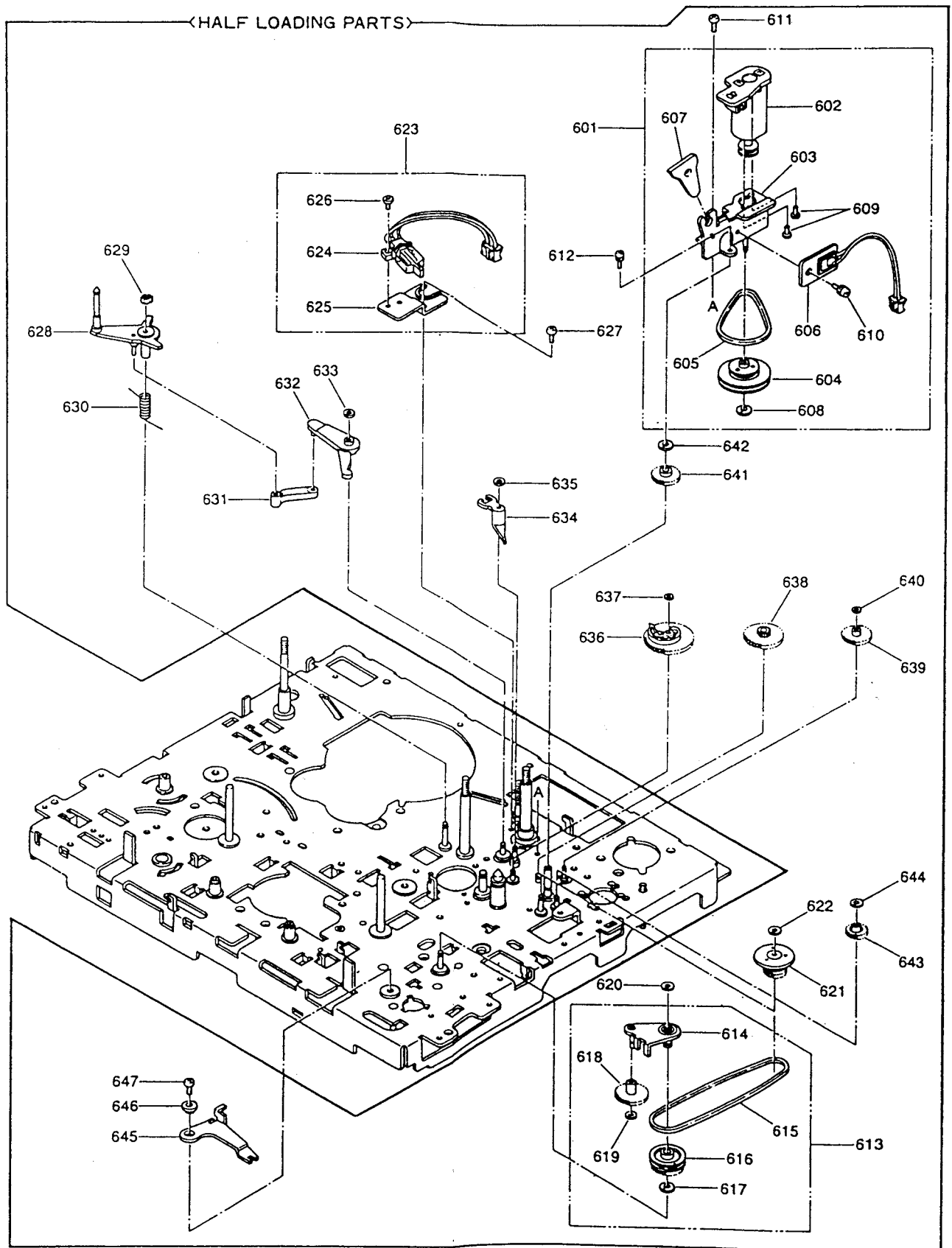

ELECTRICAL PARTS LIST

(PLEASE NOTE: ALL NUMBERS WITH PREFIX * REFER TO VCR6100)

Circ. Ref	Description	Part No.
Coils		
L1, 3, 53, 54, 57, 202	Coil 100uH 2101	150391
L2	Coil 27uH 5270	153019
L4	Coil 33uH 5330	153020
L5	Coil 47uH 5470	153021
L7,56	Coil 180uH 5181	153016
L8	Coil 18uH 5180	153018
L51	Coil 22uH 5220	153013
L52*	Coil 39uH 5390	152051
L52, 55	Coil 82uH 5820	153015
L101	Coil 330uH 2331	151424
L102	Coil 680uH D491	152052
L103	Coil 68uH 5680	153014
L103*	Coil 68uH 5680	153300
L201	Coil 18mH M500	153022
L401, 402	Coil 200uH J441	153017
T51	Eq Coil 1810585	152055
T201	Audio Osc Coil 113M686	152056
Filters		
T51*	Equalizing Coil 0585	
T52	Filter LPF 3MHz 0805	151748
T101	Filter LPF 1.5MHz D621	153023
T102	Filter BPF 4.43MHz 0804	151788
DL101	Filter Comb 2112	151746
CF101	Filter Ceramic 5.06MHz 0497	150653
X101	X'Tal 4.43MHz 1259	153024
X501	Res Ceramic 3.58MHz 2206	153026
X501*	Res Ceramic 8MHz 2791	153301
X751	Res Ceramic 500kHz 1103	153025
X801*	X'Tal 4.19MHz 1191	153027
X802*	X'Tal 32kHz 1100	153302
Potentiometer		
VR51, 101	Semi Fix 1kΩ 777	153303
VR201	Semi Fix 100kΩ 956	153304
VR401	Semi Fix 200kΩ Metal 832	153305
VR402	Semi Fix 200kΩ 786	163306
VR801	Potentiometer 250kΩ 661	152069
VR802	Potentiometer 20kΩ 703	152070
Switches		
SW801-827 824*	Switch Push 2101	153028
SW824, 831*	Switch Slide 1752	153029
Jacks		
JK201	Scart Jack 548	153030
Miscellaneous		
RS801	Remote Sensor	153031
	FIP Holder	153032
FIP801	FIP 16-MT-14GK	153033
Conv-1	RF Conv	153034
BZ801*	Piezo Buzzer PKM22EPP-4001	153307
	RCA Plug Cord	153035
	Cushion	153036
	Shield Plate Top	153037
	Shield Plate Bottom	153038
T601	Power Transformer	153039
	AC Cord	153040
	Cord Stopper	153041
	Fuse Holder	153042
F601	Fuse T-200mA	153043
F602	Fuse T-500mA	153044
TU701	Tuner IF	153045
	Remote Control Box VCR6000	153046
	Remote Control Box VCR6100	153308
	Instruction Book	UI-VCR6000
	Instruction Book	UI-VCR6100
	RF Cord	153048
TC801	Trimmer Capacitor 20pF	153309
RX501*	Resistor Network 100kΩ x 8	153310
RX801*	Resistor Network 100kΩ x 6	153311

Ref. No.	Description	Part No.
IC's		
IC1	IC AN3331K Head Amp	152034
IC51, 651	IC AN78L05/NJM78L05A Voltage Regulator	190731
IC52, 652	IC AN78N05 Voltage Regulator	151710
IC151	IC BA7021 Video Selector	153001
IC201	IC BA7767S Linear Audio	153003
IC202	IC NJM223S Audio Selector	153004
IC401	IC BA6219B Linear Capstan Drive	150608
IC402	IC MN6748 Servo Control	152047
IC402*	IC MN6747VBB Servo Control	153289
IC403*	IC MN4066/BU4066 Analog Switch	153290
IC501	IC MN158461 System Control	152048
IC501*	IC MN18881FVBD System Control	153293
IC502	IC BA6209 Linear Motor Drive	150611
IC502*	IC BA6238A Linear Motor Drive	153291
IC503*	IC MN1280	153292
IC504	IC AN6912/LA6339	152399
IC601	IC 7818F Regulator 3 Pin	151416
IC602, 604	IC AN7812F Regulator	151707
IC701	IC LA7913 Tuner Select	152025
IC702	IC L5631 Regulator	152028
IC751	IC LA7210 Tuner Select	152027
IC752	IC MN1225 Memory	152032
IC753	IC AN6913	153006
IC801	IC MN15283FVBH	153005
IC801*	IC MN187163FVBC Micro Processor	153295
IC802	IC MN1280R/Q Reset	151411
HIC51	IC Hybrid Y 2119 Luminance	152029
HIC101	IC Hybrid C 2421 Colour HIC	152030
HIC401	IC Hybrid Servo 2455	153002
HIC401*	IC Hybrid Servo 2240	153294
Transistors		
Q1	TR 2SC2058QR/2SC2839EF	151417
Q2	TR 2SC1740QR/2SC536SP	50016
Q53, 55, 101, 102, 401, 501	TR 2SC536SPEF	50016
Q54, 503-505*	TR 2SA933QR	150874
Q56	TR 2SA1317ST	152037
Q201	TR 2SC2060Q/2SD400F	50002
Q403, 602	TR 2SB892ST	150339
Q502	TR 2SA934QR	151095
Q507, 801	TR 2SC1740QR	50016
Q601	TR 2SA1016KFG	153007
Q603	TR 2SC2808RS	153008
Q651	TR 2SD1207ST	152049
Q701	TR 2SD1012FG	152041
Q702, 703	TR 2SK128TAPQ	152040
QR402, 403*, 501, 504, 507*, 508, 509*, 701*, 702*	TRDTC124ES/2SC3400	152050
QR404*, 405* 506*	TR DTA114YS	153296
QR502, 505	TR DTA143XS	152043
QR503, 701	TR DTA124ES/2SA1346	151422
QR506	TR DTA124XS	153010
QR801	TR DTA124ES	151442
Diodes		
D51, 54, 101, 151, 152, 401-406, 501-504, 506, 507, 509-511 701, 751, 752, 754	D 1SS254	150624
D251, 801-816	D US1040M	150624
D508, 606	DZ UZ6.2BSC	153298
D601, 602	D ISR35-200A/1N4003/GP10-4003	152073
D603	DZ MTZ30A	152074
D607	D KBL02L/RS403L/S4VB20	152075
D608-611	D IN4003	152073
D612	D ISS252/DS446/US1090M	153011

Description	Circuit Reference	Part No.
Resistors (All resistors are 1/5W unless otherwise stated)		
4.7Ω	R2, 204	152146
22Ω	R201	152156
47Ω	R202	152160
68Ω	R61	152162
82Ω	R73, 156	152164
100Ω	R226, 419, 604, 605	152166
150Ω	R431	152168
180Ω	R224, 505*, 512	152169
270Ω	R14, 104	152171
390Ω	R8, 63	152173
470Ω	R4, 11, 227	152174
560Ω	R6, 19, 58, 207, 208, 422*	152175
680Ω	R9, 65	152176
750Ω	R759	152177
820Ω	R12, 756	152178
1kΩ	R5, 10, 15, 60, 64, 69, 105, 418, 440*, 506*, 509*, 512*, 758, 763	152179
1.2kΩ	R59, 503, 611, 651	152180
1.5kΩ	R3, 67, 218, 253, 411, 434, 708, 766, 768	152181
1.8kΩ	R13, 103	152182
2.2kΩ	R16-18, 68, 106, 252, 255, 414, 416, 422, 802	152183
2.7kΩ	R402, 404, 423*, 514-516	152184
3.3kΩ	R412*, 413*, 517, 711, 804, 805	152185
3.6kΩ	R510, 523*	152186
3.9kΩ	R211, 712	152187
4.7kΩ	R51, 71, 214, 408, 415, 424*, 501, 532*, 751, 771, 773	152188
5.6kΩ	R102, 213, 223	152189
6.8kΩ	R66, 203, 435, 519-521*	152190
7.5kΩ	R407*	152191
8.2kΩ	R219	152192
10kΩ	R7, 154, 206, 212, 222, 228, 229, 407, 414*, 420, 421, 426, 427, 505, 508, 533*, 652, 709, 716, 752, 753, 801*, 807	152194
12kΩ	R231, 437*, 438*, 529*, 530*, 760-762	152195
13kΩ	R432	
15kΩ	R713, 765	152196
18kΩ	R57	152197
22kΩ	R205, 210, 217, 220, 252, 255, 606, 613, 614, 702, 755, 767	152198
33kΩ	R215, 225, 430, 707, 803	152200
39kΩ	R403, 405	152201
47kΩ	R72, 412, 428, 433, 436*, 439*, 504, 507*, 508*, 509, 511, 513-516*, 522*, 524*, 527*, 529*, 534*, 608, 612, 714, 769, 770, 777-779, 801, 802-805*	152203
56kΩ	R70, 710	152204
82kΩ	R502	152207
100kΩ	R155, 531*, 610, 754, 780, 781	152209
220kΩ	R525*, 526*, 703-705, 808*	152213
330kΩ	R757	152215
390kΩ	R221	152216
470kΩ	R413, 506, 507, 706	152217
1MΩ	R216, 717	152223
Oxide Film Resistors		
1.5Ω/1W	R429	150903
3.3Ω/1W	R513, 518*	151608
3.3Ω/2W	R401	153315
330Ω/1W	R62	151593
1.2kΩ	R602	153316
Polyester Film Capacitors		
0.015uF/50V	C706, 707	152389
0.033uF/50V	C424	151600
0.047uF/50V	C201	152089
0.15uF/50V	C407	152648

Description	Circuit Reference	Part No.
Ceramic Capacitors		
7pF	C802	153317
10pF	C62, 801	150873
12pF	C11	150873
22pF	C18, 25	150511
27pF	C26	150513
30pF	C803, 804	153318
33pF	C59	24029
56pF	C21	810311
68pF	C63	150516
82pF	C24	150517
100pF	C19, 226, 760*	24016
120pF	C60	150482
150pF	C64	151304
220pF	C66, 71, 105, 155*, 205	400107
270pF	C104, 754	150491
330pF	C234*, 756	150518
390pF	C23	153320
1000pF	C10	151645
0.001uF	C216, 710, 757	150518
0.0012uF	C224	153321
0.0018uF	C223	153322
0.0022uF	C434*	152644
0.0039uF	C252	153323
0.0082uF	C432*	153324
0.01uF	C1, 3, 12, 13, 15-17, 101, 102, 231, 805, 806	810312
0.022uF	C67, 109*, 152, 231-233, 601, 602, 758, 802, 803	21027
0.033uF	C5, 8	153325
0.047uF	C712*, 758*	152645
0.056uF	C433*	153326
Semi-Conductive Capacitors		
0.0033uF/25V	C217	151581
0.0047uF/25V	C425, 426	151582
0.01uF/25V	C203, 204, 210, 219, 421, 431*, 501*	152084
0.015uF/25V	C211	153327
0.022uF/25V	C409	151585
0.033uF/25V	C409*	151586
0.033uF/50V	C705, 708	152086
0.047uF/16V	C68*, 106, 107*, 412	152087
0.047uF/25V	C415, 430*	151311
0.1uF/12V	C215, 423, 427	152646
0.1uF/25V	C401, 403-405, 505, 506, 507*	150887
Electrolytic Capacitors		
0.1uF/50V	C703, 704	150908
0.22uF/50V	C153, 406	152546
0.47uF/50V	C227, 752, 755	151641
1uF/50V	C4, 9, 20, 213, 218, 408, 411, 414, 652, 654, 753	20062
1uF/50V NPO	C410, 417*, 429*	153328
2.2uF/50V	C214, 503	151598
2.2uF/50V NPO	C417	152079
3.3uF/50V	C208	152080
4.7uF/25V	C209, 419*	20065
4.7uF/25V (AXI)	C222	153329
4.7uF/25V NPO	C503	153330
8.2uF/16V	C418	153331
10uF/16V	C53, 54, 57, 151, 154, 220, 228, 229, 416, 420, 651, 653, 709	20148
10uF/16V NPO	C58	20037
22uF/16V	C65, 606	151308
33uF/16V	C207	20026
47uF/6.3V	C221, 419, 759	151327
47uF/10V/16V	C422	20027
47uF/16V	C14, 51, 52, 202, 610, 611, 751	20027
47uF/25V	C609*	151640
47uF/35V	C608, 701	152081
47uF/63V	C607*	152096
100uF/6.3V	C801*, 804	153297
100uF/16V	C56, 206, 230, 504, 702	20028
100uF/25V	C402*	20028
220uF/6.3V	C2, 61, 108	151309
330uF/6.3V	C69, 70	152082
470uF/16V	C428*	1400248
1000uF/6.3V	C55, 711	20118
2200uF/25V	C604*	151310
2200uF/35V	C603*	152097
3300uF/16V	C605*	152098

17-1 AUDIO/HEAD AMP/POWER SUPPLY VCM8000/0100

5mV
20uS

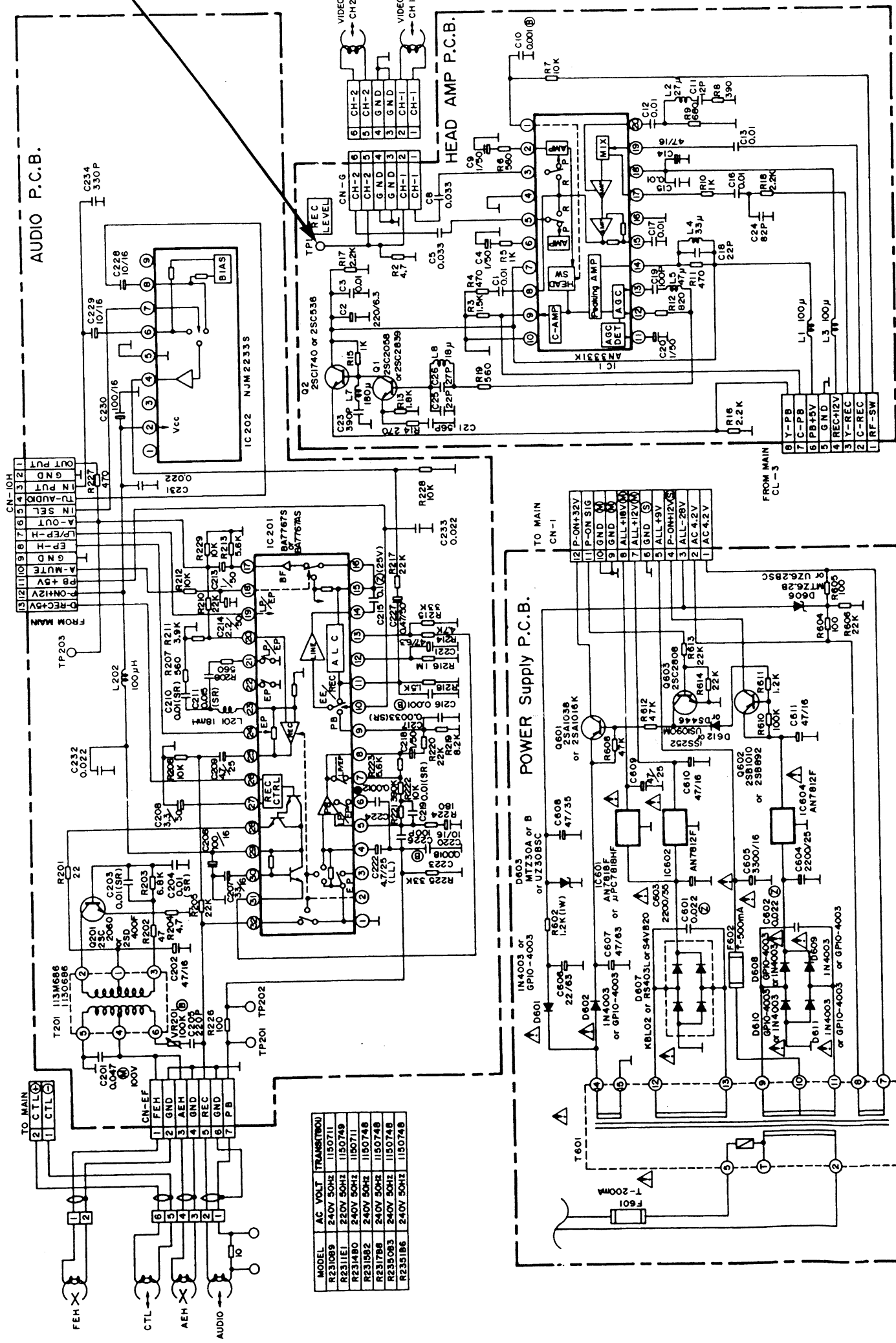

MODEL	AC VOLT	TRANSISTOR
R2310B9	240V 50HZ	I150711
R2311E1	220V 50HZ	I150749
R2314B0	240V 50HZ	I150711
R2315B2	240V 50HZ	I150748
R2317B8	240V 50HZ	I150748
R2350B3	240V 50HZ	I150748
R2351B6	240V 50HZ	I150748

17-2 TIMER/CONTROL/TUNER/JOINT VCR6000

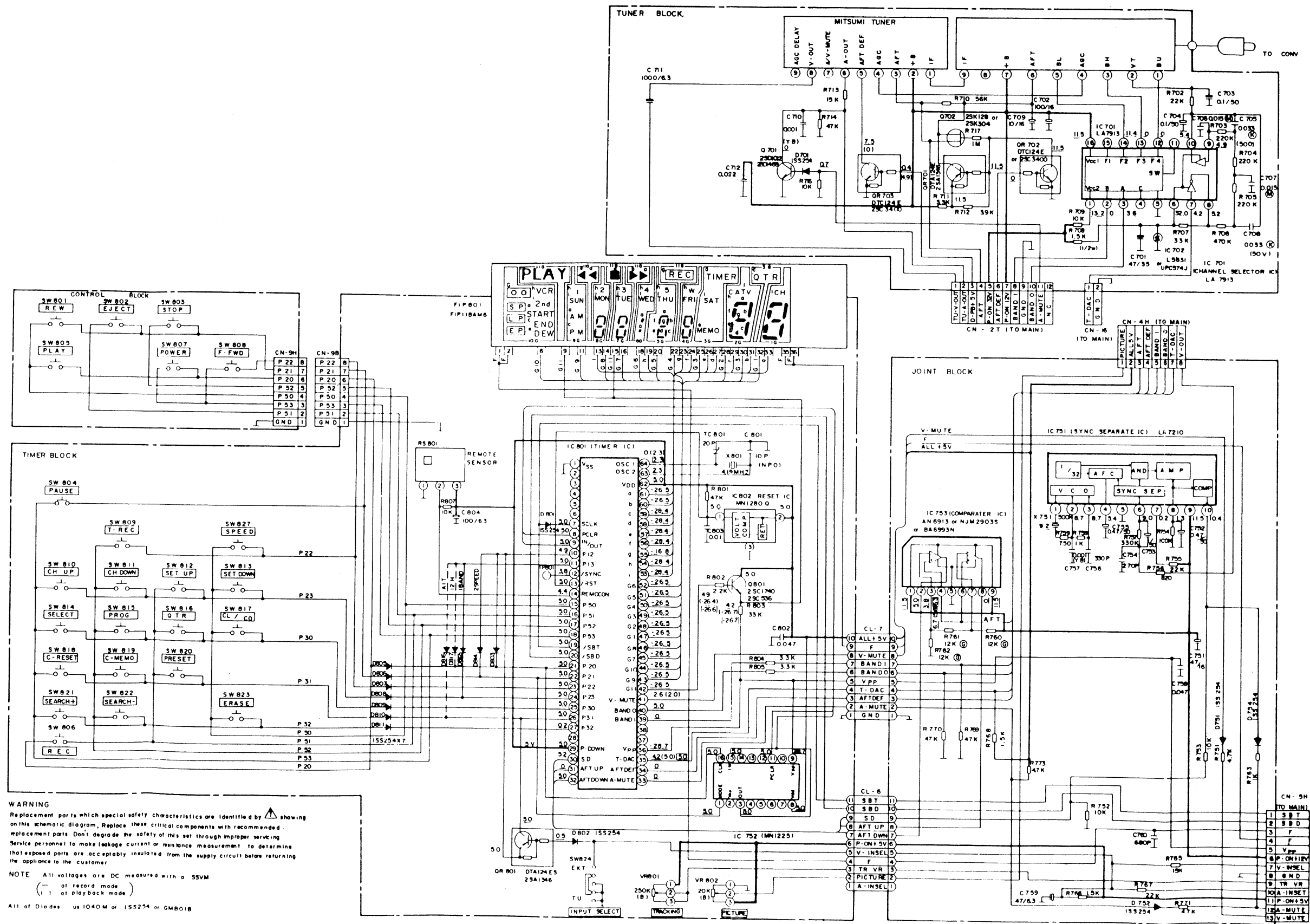

WARNING
 Replacement parts which special safety characteristics are identified by showing on this schematic diagram. Replace these critical components with recommended replacement parts. Don't degrade the safety of this set through improper servicing. Service personnel to make leakage current or resistance measurement to determine that exposed parts are acceptably insulated from the supply circuit before returning the appliance to the customer.

NOTE All voltages are DC measured with a 55VM
 () at record mode
 (|) at playback mode

All Diodes: us 1040M or 1S5254 or GM801B

17-2 TIMER/CONTROL/TUNER/JOINT VCR6100

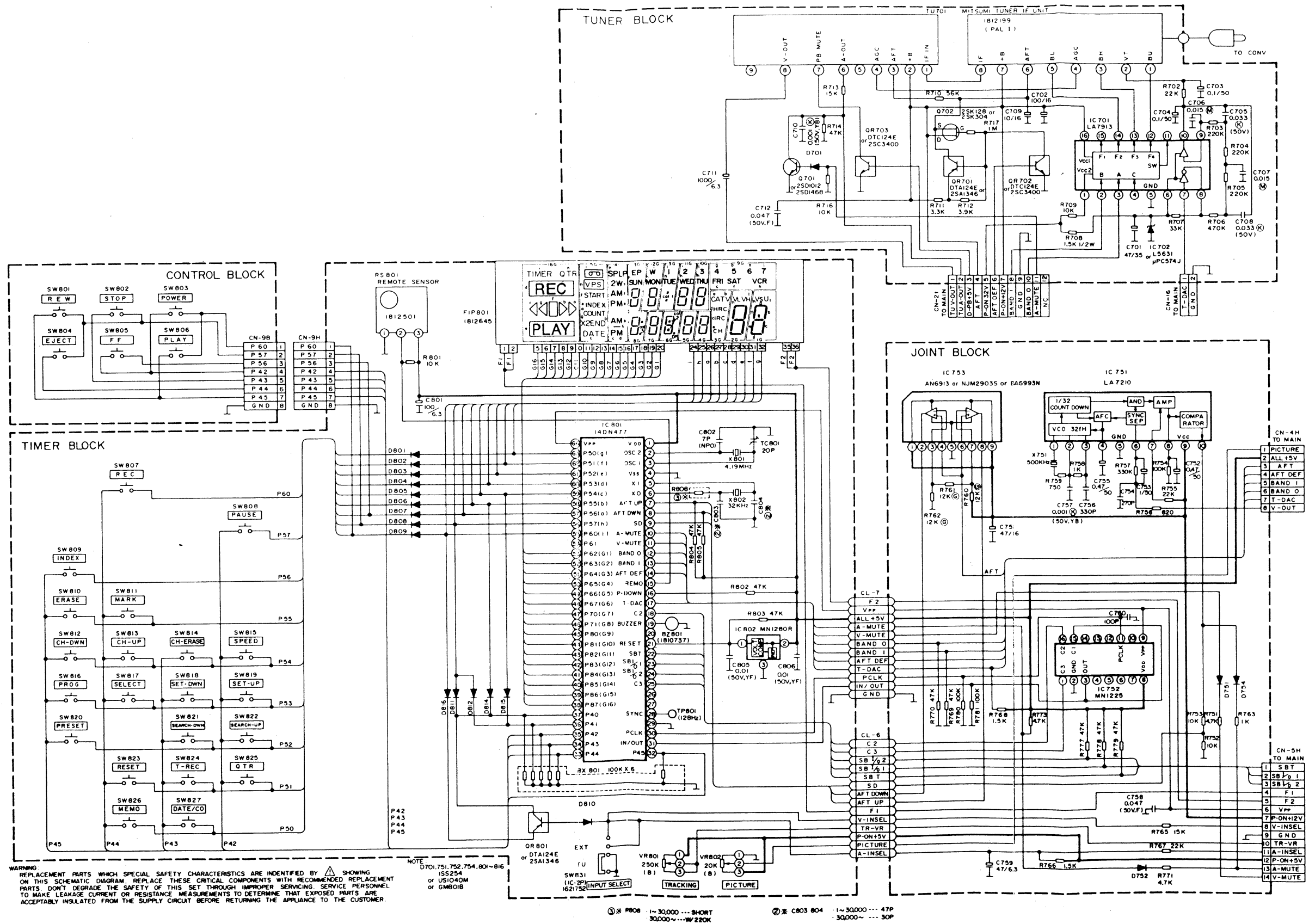

WAVE FORMS

THIS INFORMATION REFERS TO VCR6100 VIDEO/SERVO/SYSTEM CONTROL SCHEMATIC DIAGRAM. ILLUSTRATED ON PAGE 120.



1ch (CTL)
0.2v/div.
2ch (RF SW)
0.2v/div.
5ms/div.

PLAY MODE



10mV/div.
10uS/div. REC MODE

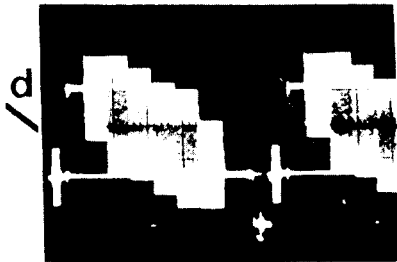

10uS/div.
20uV/div. E-E MODE

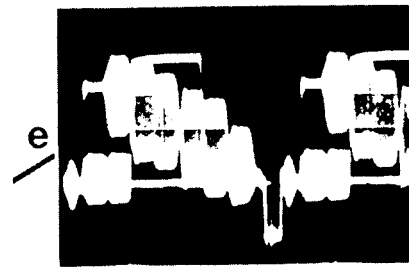

10uS/div.
20mV/div. PLAY MODE

WARNING:

REPLACEMENT PARTS WHICH HAVE SPECIAL SAFETY CHARACTERISTICS ARE IDENTIFIED BY Δ SHOWING ON THIS SCHEMATIC DIAGRAM. REPLACE THESE CRITICAL COMPONENTS WITH RECOMMENDED REPLACEMENT PARTS. DON'T DEGRADE THE SAFETY OF THIS SET THROUGH IMPROPER SERVICING. SERVICE PERSONNEL SHOULD MAKE LEAKAGE-CURRENT OR RESISTANCE MEASUREMENTS TO DETERMINE THAT EXPOSED PARTS ARE ACCEPTABLY INSULATED FROM THE SUPPLY CIRCUIT BEFORE RETURNING THE APPLIANCE TO THE CUSTOMER.

NOTES:

1. ALL RESISTANCE VALUES ARE INDICATED BY Ω .
2. ALL CAPACITANCE VALUES ARE INDICATED BY μ .
3. VOLTAGES ARE MEASURED WITH SSVV CATED TO CHASSIS GROUND AT NO S NOTED. (SEE VOLTAGE CHART.)
4. CAPACITOR TYPES ARE (PL) - POLY. (M) - MYLAR, OTHERS ARE CERAMIC.

WAVE FORMS

THIS INFORMATION REFERS TO VCR6000 VIDEO/SERVO/SYSTEM CONTROL SCHEMATIC DIAGRAM.
ILLUSTRATED ON PAGE 119.

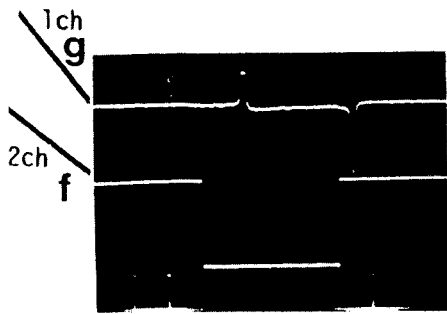

1ch (CTL)
0.1mV/div.
5mS/div. PLAY MODE

2ch (RF SW)
0.2mV/div.
5mS/div. PLAY MODE

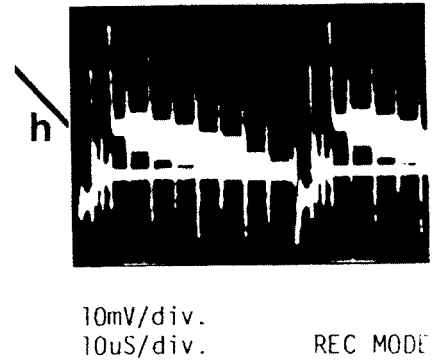

10mV/div.
10uS/div. REC MODE

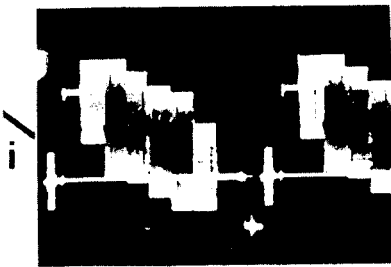





10uS/div.
20uV/div. E-E MODE



10uS/div.
20mV/div. PLAY MODE

NOTE: All voltages are DC measured with a SSVM.
The DC voltage measured at E-E mode.

- ( : at record mode.)
- ( : at playback mode.)
- ( : Fusing resistor
- ( : Safety material

Ω IN OHM (K = 10³, M=10⁶).
FED IN μF (P = 10⁻⁶ μF).
1 (Z: > 10K OHM) FRONT POINT INDIC-
GIONAL CONDITION UNLESS OTHERWISE
ROPYLANE, (SC) = SEMI-CONDUCTIVE.

VCR6000 VIDEO/SERVO/SYSTEM CONTROL SCHEMATIC DIAGRAM. FOR WAVE FORMS SEE PAGE 118.

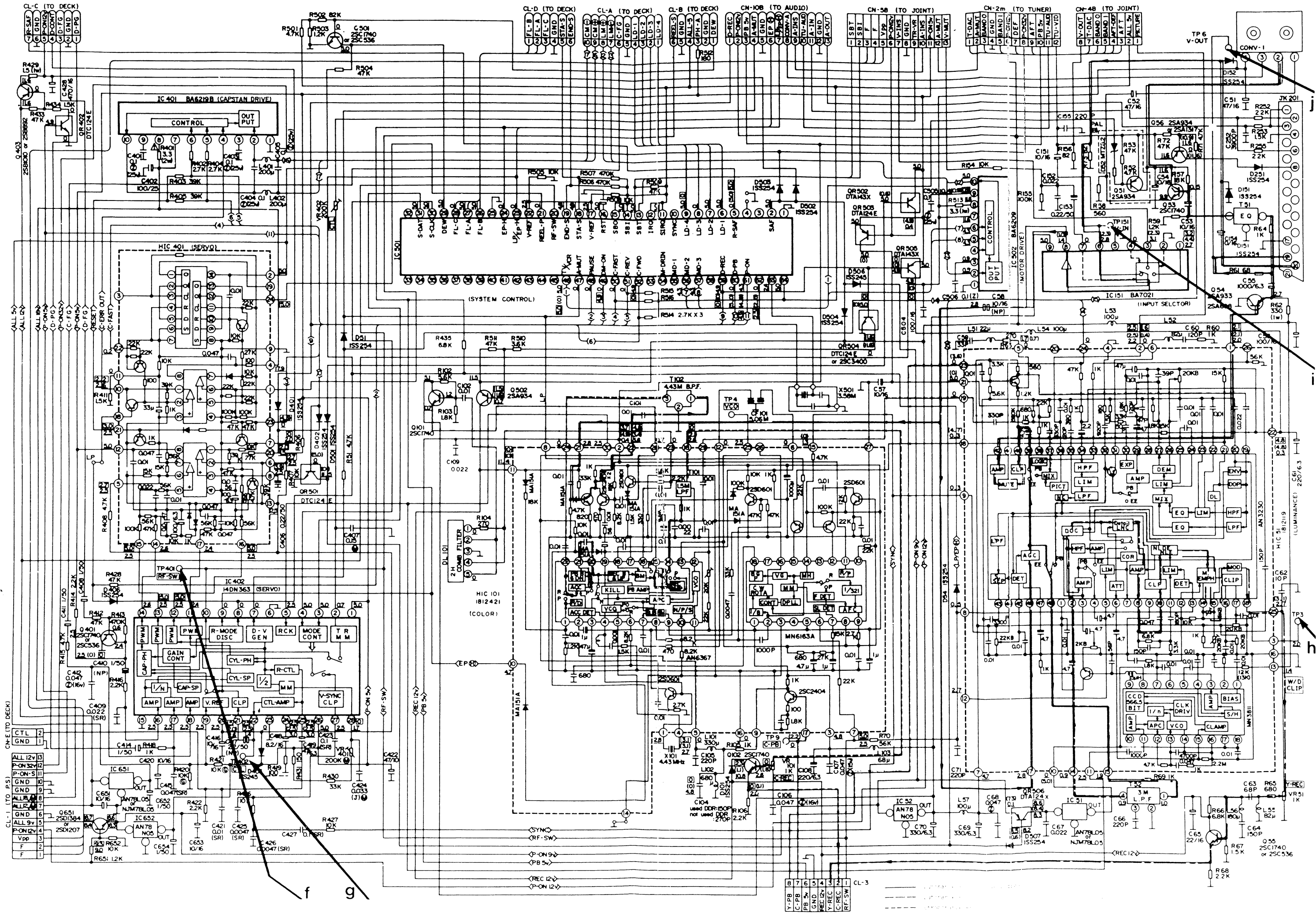

VCR6100 VIDEO/SERVO/SYSTEM CONTROL SCHEMATIC DIAGRAM. FOR WAVE FORMS SEE PAGE 118.

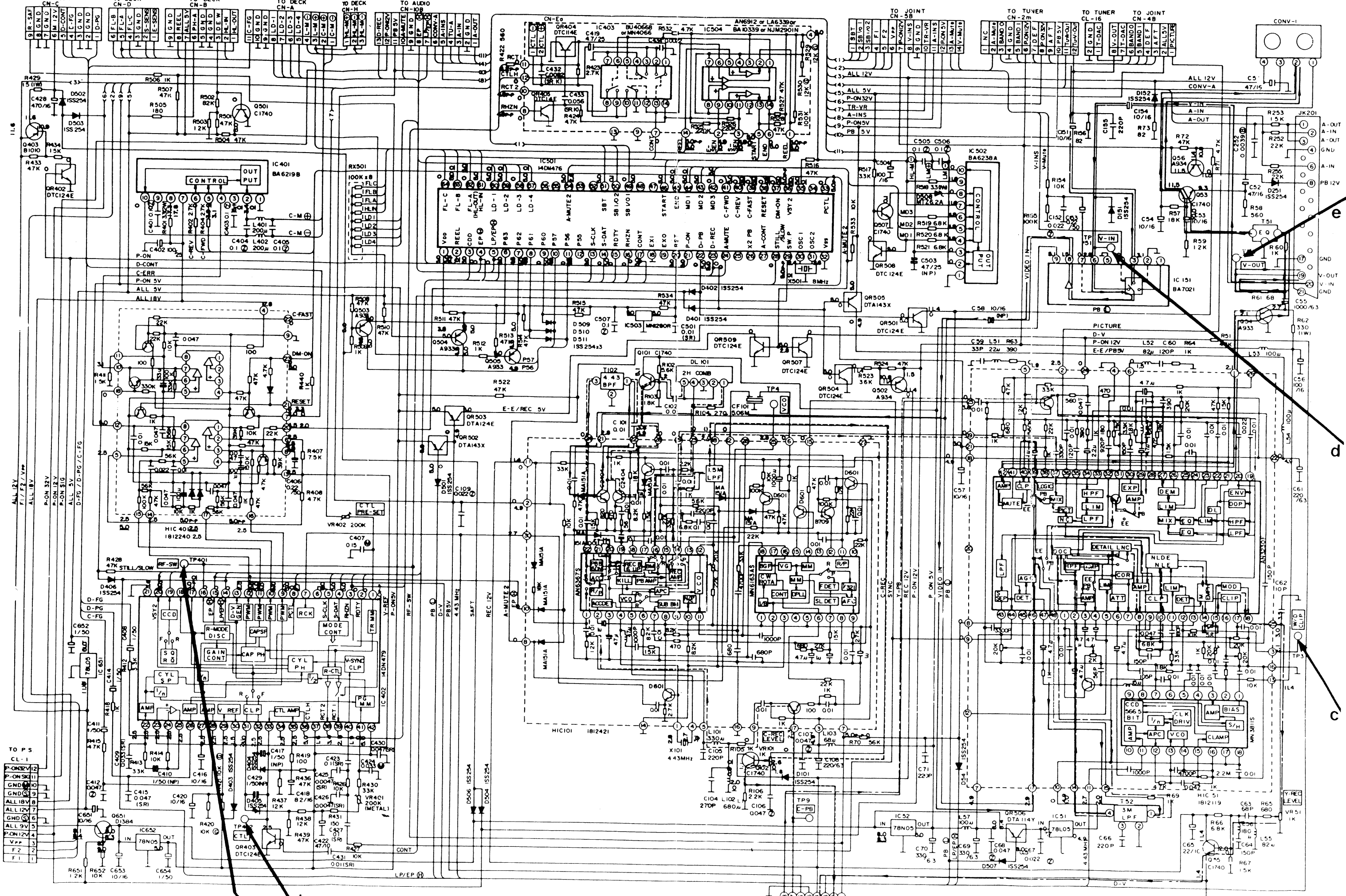

a b

--- Luminance + Chrominance (PLAY)
 - - - Luminance (REC)
 . . . Chrominance (REC)

TO HEAD AMP
 CL-3

c
 d
 e