

Amstrad



MEGAPC3H40
WITH GAMES CARD
PC14DSM
14" DUAL SYNCH COLOUR MONITOR
SERVICE MANUAL

Amstrad MegaPC 386SX

Specification

Processor and Clock Speed	PC Mode: 25MHz 80386sx Mega Mode: 8MHz 68000
Main on-board Memory	1Mb RAM on-board
Memory Expansion	Up to 16Mb via 4 SIMM sockets
Hard Drive - fitted as standard	40Mb Fast Access (28ms)
Floppy Disk Drive - fitted as standard	3.5" 1.44Mb
Disk Drive Bays	1 x 3.5" third height FDD bay 1 x 3.5" half height HDD bay
Expansion Slots	2 x 16 bit, $\frac{2}{3}$ length ISA slots - one populated and one free
Graphics	Super VGA** (VGA, EGA, CGA, MDA and Hercules Compatible)
Video Memory	256Kb (user expandable up to 512Kb)
Maximum Resolution	**PC Mode: 1024 x 768 pixels Mega Mode: 320 x 224
On-screen Colours	PC Mode: Up to 256 (max) from a total palette of 262,144 Mega Mode: Up to 64 (max) out of total palette of 512
Sound Capability	PC Mode: Full Ad-Lib sound Mega Mode: Full Megadrive Stereo Sound
External Interfaces	Parallel Port, Twin RS232C Serial Ports, PS/2 type Keyboard Socket, PS/2 type Mouse Socket, External VGA Monitor Port, External VGA Monitor Power Socket, PC analogue Joystick port, 2 Sega compatible Games Paddle ports, Megadrive compatible cartridge slot, MegaCD compatible connector, Stereo Headphones socket
Power Supply	50W 110/220-240V Auto-Switching
System Unit Dimensions	325mm (W) x 78mm (H) x 292mm (D)
Keyboard	102 key high quality PS/2 type
Supplied Accessories	Two button PS/2 type PC Mouse, precision analogue PC Joystick, Sega compatible Games Paddle
Supplied Software	MS-DOS 5.0, Amstrad Desktop User-friendly Graphical Interface with on-screen interactive Tutorial
Colour Monitor	14" Hi-Res Dual Sync Colour with in-built stereo speakers
Monitor Compatibility	Full VGA with Ad-Lib sound, full Megadrive with stereo sound
Monitor Graphics Resolution	PC Mode: 640 x 480 Mega Mode: 320 x 224

**PC Graphics capabilities dependant on monitor type used.

NOTE FOR ENGINEERS

THIS SERVICE MANUAL COVERS MEGAPC3H40 GAMES CARD ONLY

**PLEASE NOTE, THE MAIN CPU UNIT IS SAME AS
PC7386SX, ANY REPAIRS TO THIS SECTION, REFER TO
PC7386SX SERVICE MANUAL PT. NO. 273930**

MEGAPC3H40 MANUFACTURED UNDER LICENCE FROM SEGA

MEGAPC3H40.

REF. NO.	DESCRIPTION.	PT. NO.
CABINET PARTS 1ST		
A-1X	FRONT PANEL ASSY COMPLETE	274026
A-2	LED LENS A	
A-3	LED LENS B	
A-4	VR KNOB	273892
A-5	KBD MOUSE COVER	
A-6	FOOT	274038
A-7	FRONT SLIDE DOOR	273955
A-8	RATING LABEL	
A-9	HDD SETUP LABEL	
A-10	SERIAL NO. LABEL	
A-11	SLOT COVER	273956
A-12	SL VR KNOB	274027
A-13	SL KNOB GUIDE	274028
A-14	DOOR SWITCH GUIDE	274029
A-15	CARTRIDGE DOOR A	273957
A-16	RESET BUTTON	274030
A-17	BOTTOM	
A-18	COVER	273893
A-19	REAR CHASSIS ASSY	
A-20	REAR CHASSIS	
A-21	REAR CHASSIS BRACKET	
A-22	VR BRACKET	
A-23	EXPANSION SLOT COVER	273914
A-24	CARTRIDGE DOOR B	274037
A-25	LICENSE LABEL	
A-26	JOYSTICK LABEL	
B-1	FDD BRACKET	
B-2	BAR	
B-3	JACK HOLDER	
B-4	BRAND LABEL	
B-5	SHIELD PLATE A	
B-6	SHIELD PLATE B	
B-7	DOOR SPRING	273958
B-8	JACK COVER	
B2-1	PCB HOLDER L	
B2-2	PCB HOLDER R	
B2-3	EXPANSION BRACKET	
B2-4	EDGE CAP	
B2-5	D-SUB HOLDER	
B2-6	INSULATION SHEET L	
B2-7	INSULATION SHEET R	
ICS		
U3	IC FM OPERATOR YM3812-F	273964
U12	IC SEGA 315-5487	273963
U11A	IC NE5680N TIMER	174042
U31,32	IC NJM2070M AMP	273968
U5,22	IC LM324 SPM	273967
U6	IC DAC YM3014B-F	273965
U18	IC CPU MC68HC000FN8	273966
U13	IC Z80 Z0840004PSC DIL	40080
U16,17	IC HM534612P-12 VRAM	274039
U19,20	IC 65256BLFP-10 DRAM CLOCK	274040
MISCELLANEOUS		
	SET POLY PACKING	273972
	PADDLE PAD	274031
	MOUSE MSPS2	272710
	PADDLE SP-7	273991
	JOYSTICK AJ-5	273990
	COMPLETE KEYBOARD ASSY UK	273895
	COMPLETE KEYBOARD ASSY AU	273901
	MAINS LEAD UK	270053
	MAINS LEAD AU	274032
	USER INSTRUCTIONS	274033
DE-1	HDD 40MB SEAGATE	273908
DE-2	FDD 3.5" SONY	273723
DE-3	POWER SUPPLY UNIT	273888
DE-4	256K SIMM MODULE	272201
DE-5	IC 80386SX-25	273932
DE-6	CPU PCB MAIN	273894
DE-7	LED GREEN RT-2553YQ	
DE-8	LED AMBER RT-2553A	
DE-9	VROT 500 GB	273922
DE-10	SPRAKER	273923
DE-11	6P-MINI DIN JACK	
DE-18	98P CARD-EDGE CONNECTOR	274035
DE2-4	D-SUB CONNECTOR 9P	
DE2-5	MICRO SWITCH KB001	273959
DE2-6	PUSH SWITCH AL001	273960
DE2-7	SLIDE SWITCH AL008	273961
DE2-8	SLIDE VR 10KQ	274036
F-1	34P FDD CABLE	273925
F-2	40P HDD CABLE	273926
U15	CRYSTAL 53.2034MHZ	274041
	COMPLETE KEYBOARD UK	273895
	COMPLETE KEYBOARD AUSTRALIA	273901
	TR 25C1815 Y	170447
	TR 25A1015 Y	170453

MEGA PC EXPLODED VIEW

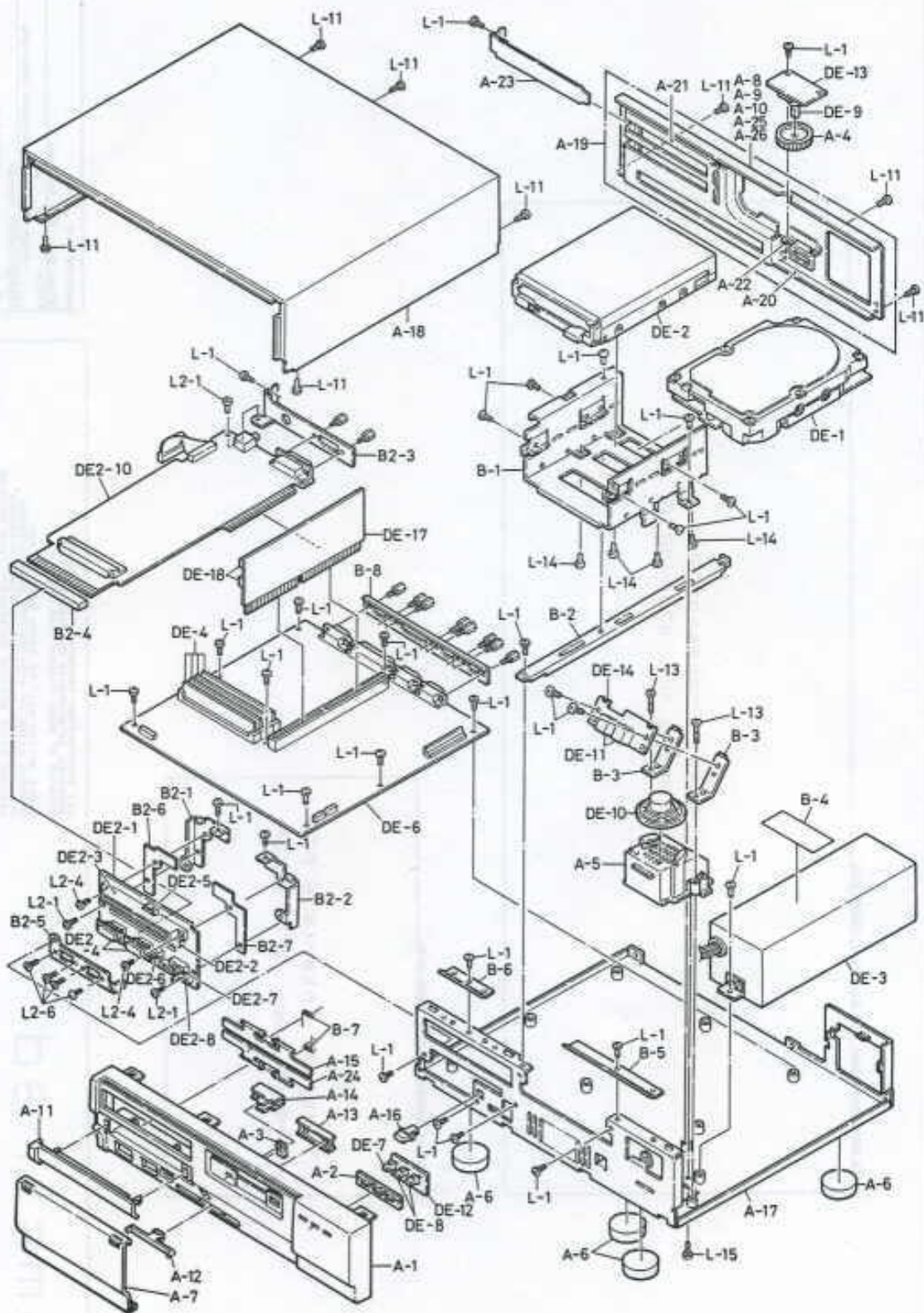

Main Bus Processor PCB Circuits (7300-100)

Games Processor PCB
Drawing No. 4700-001P

Vertical Interface PCB (7300-800)

Vertical Interface PCB
Drawing No. 4700-002P

All information contained in this set of drawings is the property of Amstrad PLC. No part of this set of drawings may be reproduced, stored in a retrieval system, or transmitted in any form or by any means, electronic, mechanical, photocopying, recording, or by any information storage or retrieval system, without prior written permission from Amstrad.

Amstrad PLC
Drum, R., - Rob. Hopkins
Title
Mega-PC System Circuit Diagrams
Size
Document Number
7000-000
REV
0
DATE
1988-08-01
1
1

Amstrad

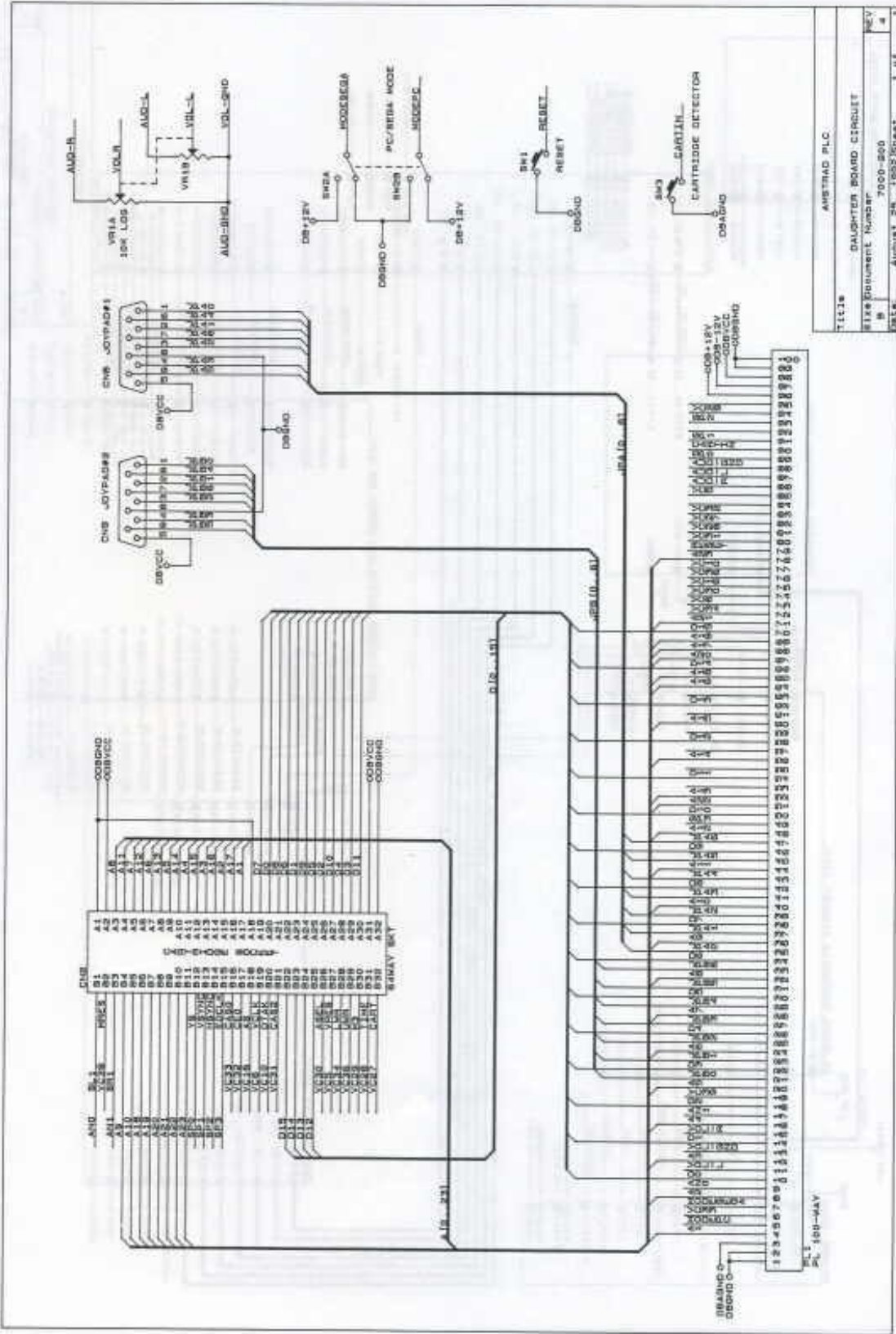

TITLE AMSTRAD PLC
 DAUGHTER BOARD CIRCUIT
 Drawn Number 7000-200
 REV 1
 DATE August 25, 1982 Sheet 1 of 1

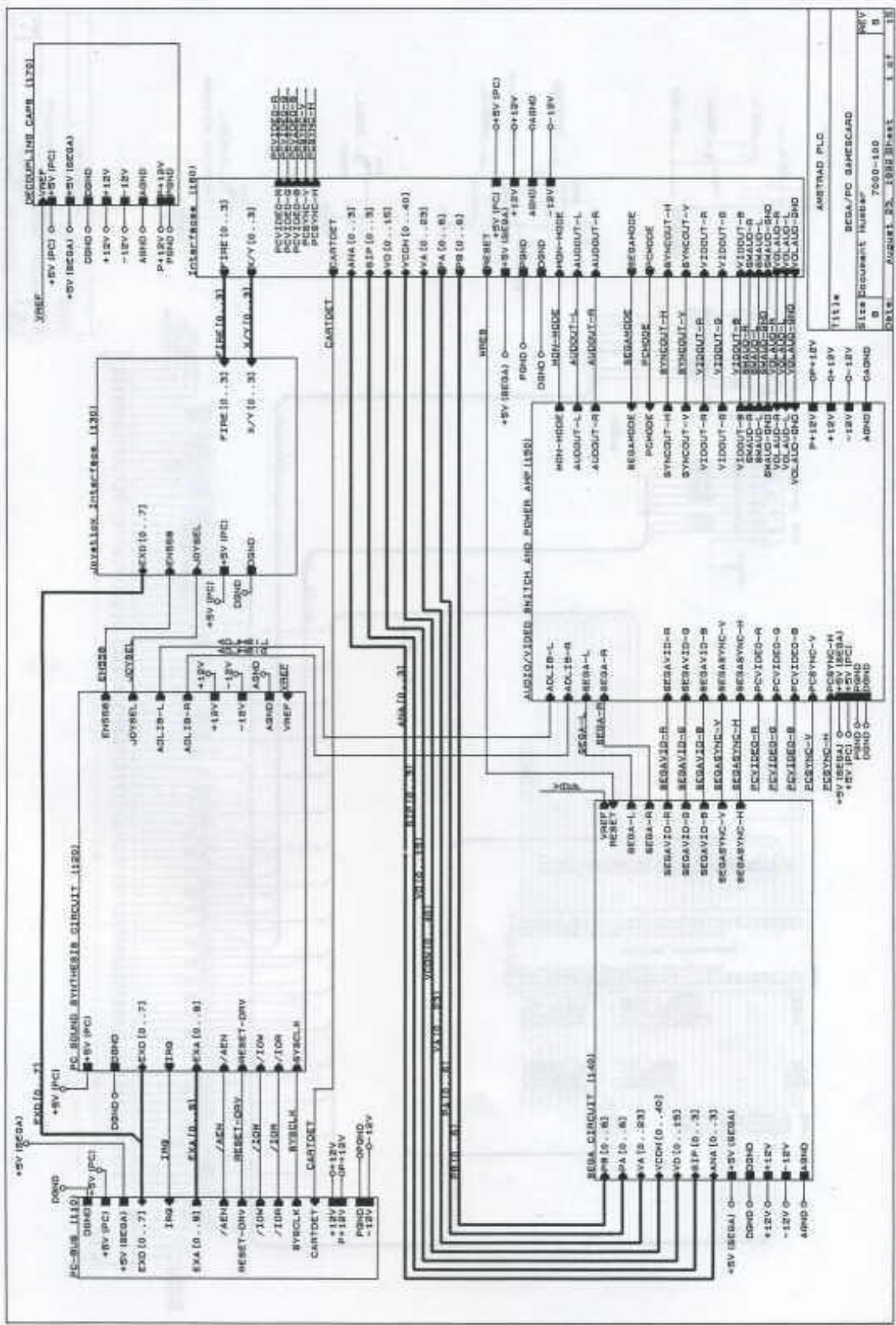

DATE: August 25, 1988 Sheet 1 of 18

AMSTRAD PLC

SEGA/PC GAMECARD

Size Encountered: 7600-100

REV: B

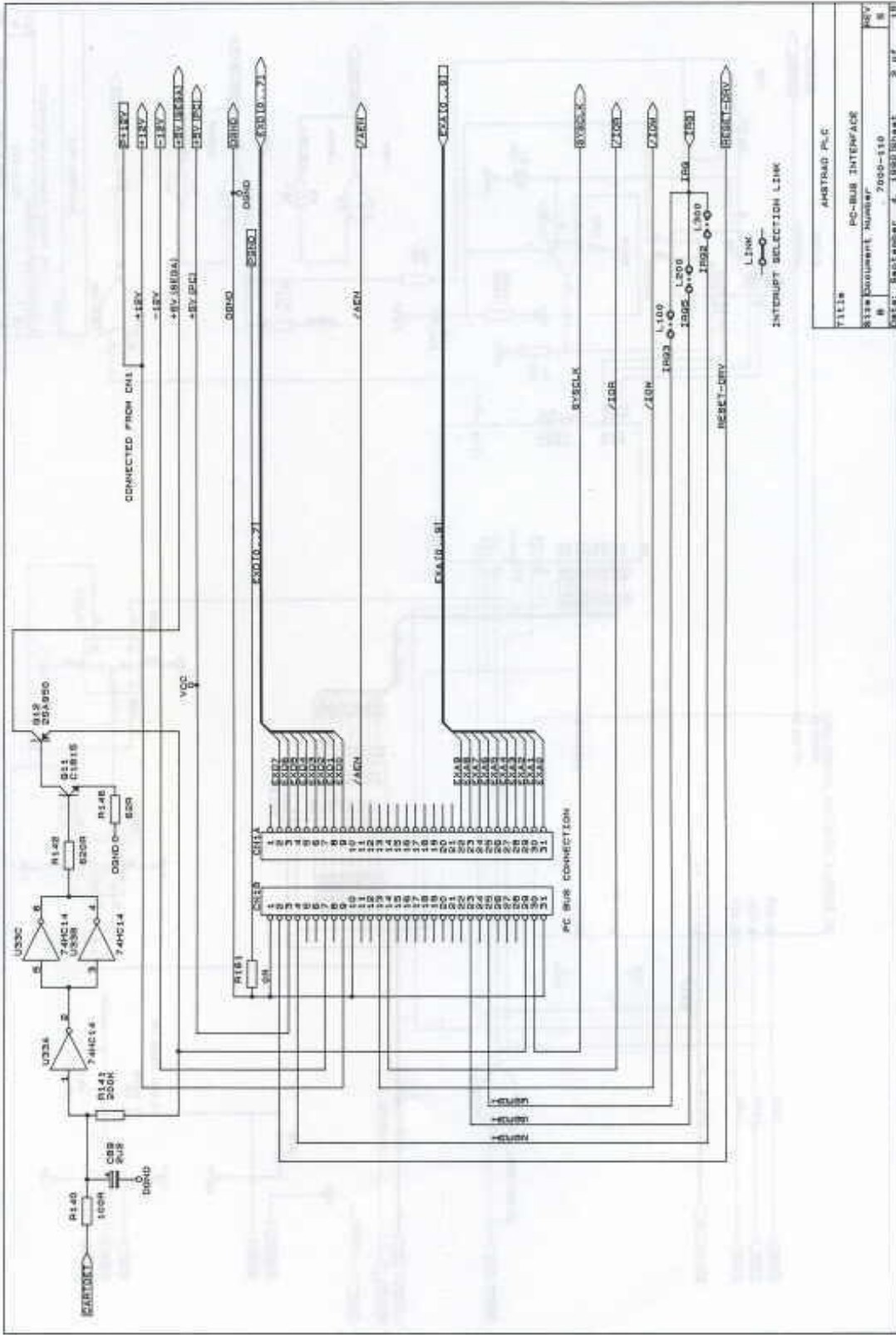

TITLE	AMSTRAD P.C.
SIZE	PC-BUS INTERFACE
DOCUMENT NUMBER	2000-110
REV	1
DATE	SEP 81
SHEET	2 OF 3

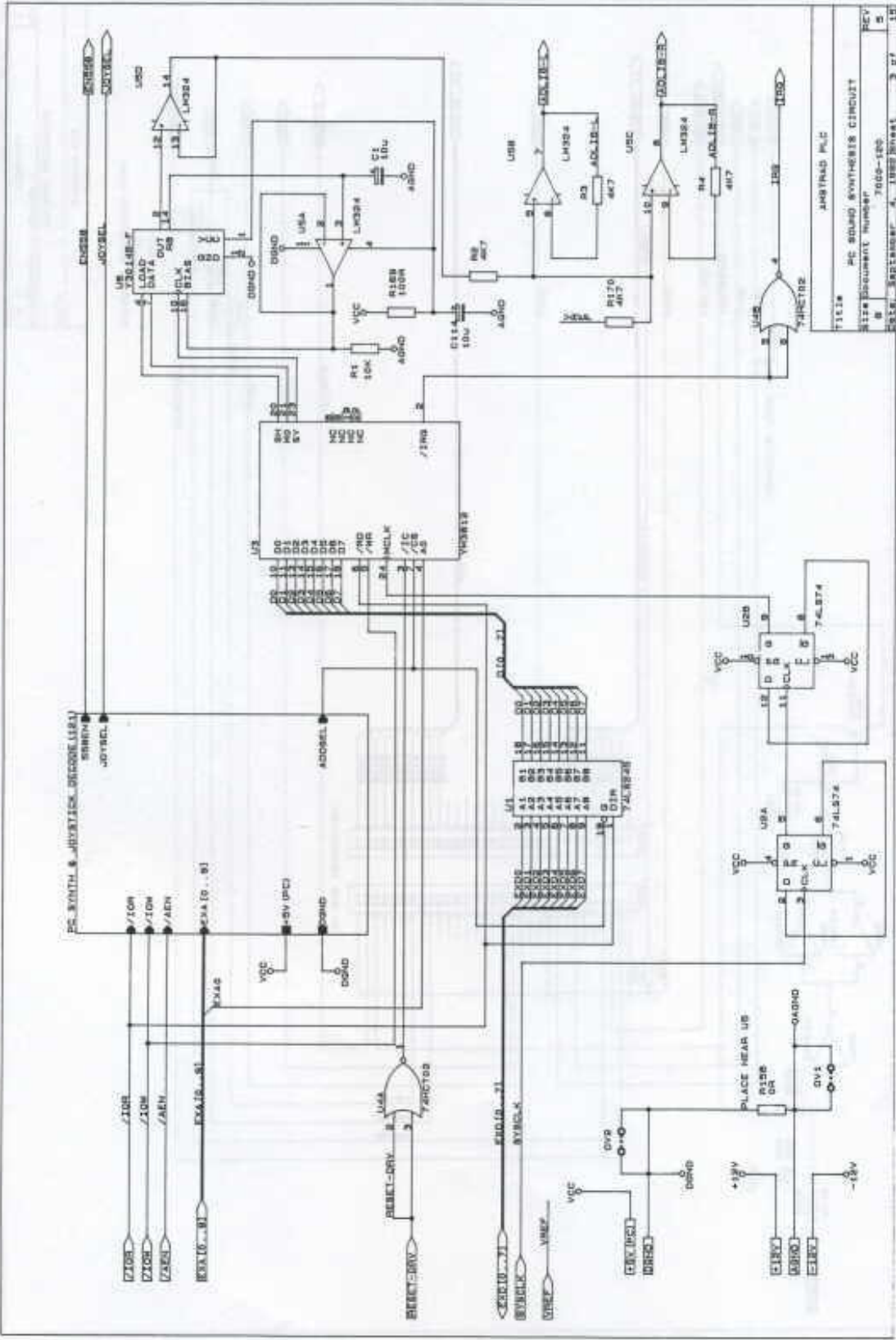

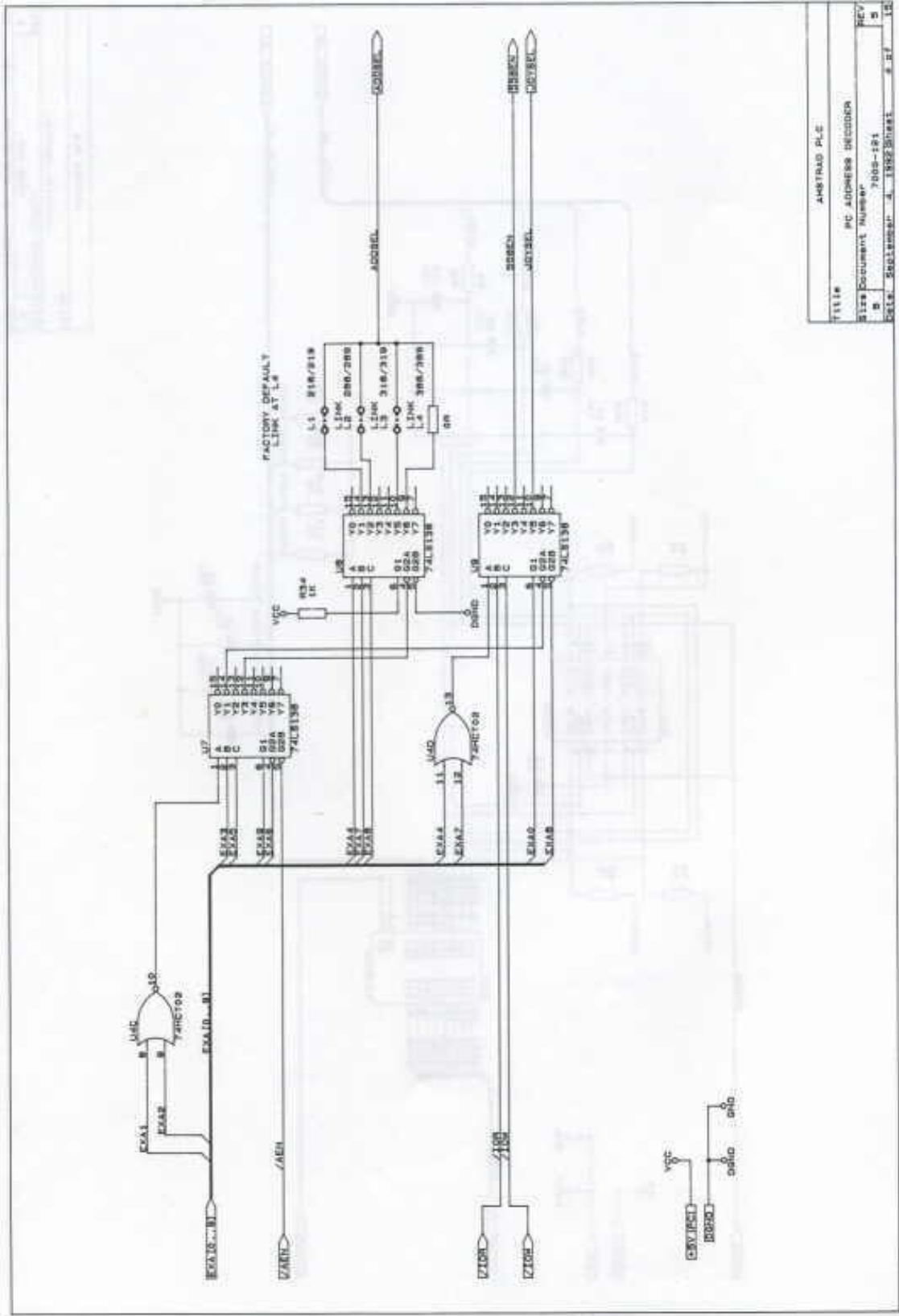

Title		AMSTRAD PLC
Size		PC ADDRESS DECODER
Doc. Number	7000-121	REV
Doc. Submitter	J. THOMPSON	REV
		REV

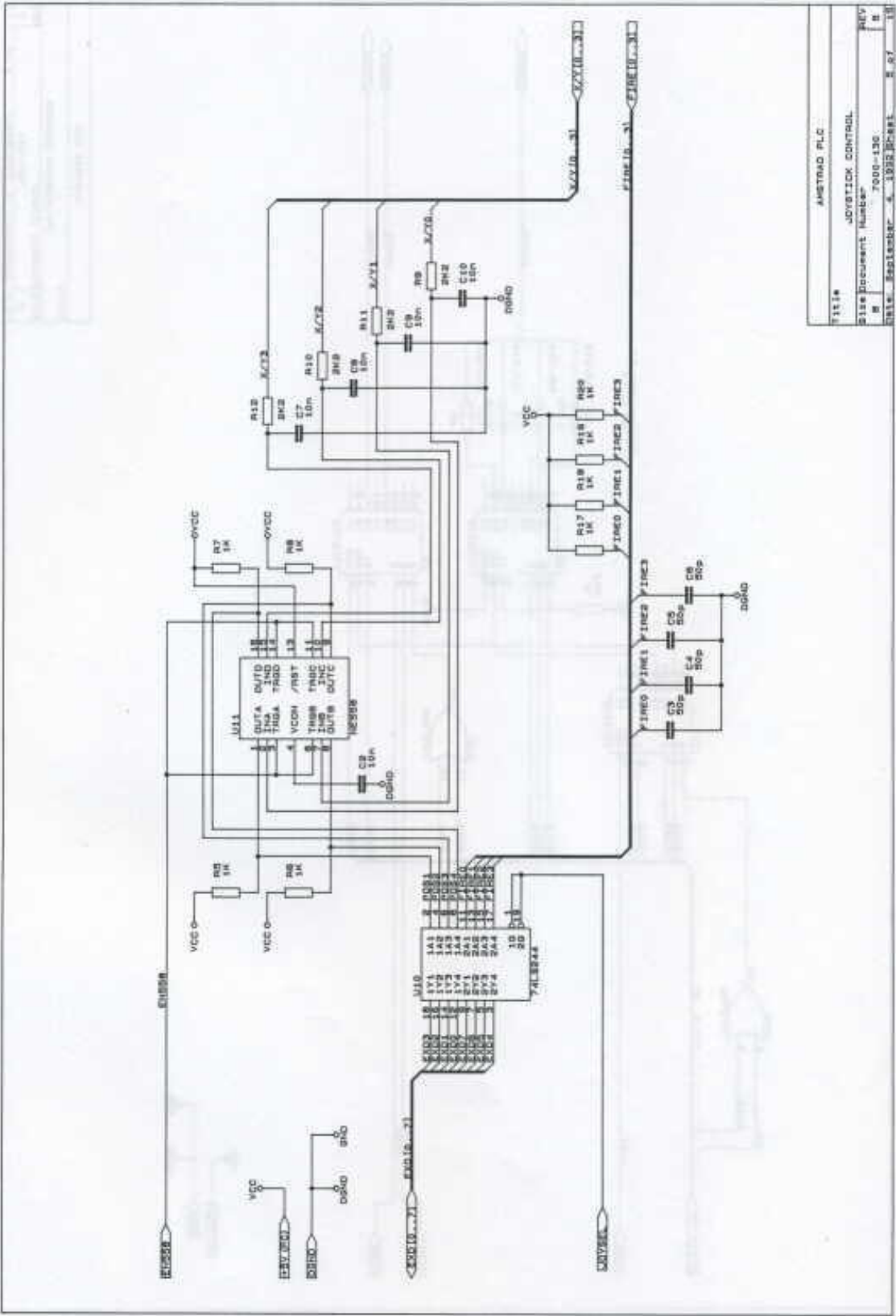

File#	ALMTRAD PLC
Size	JOYSTICK CONTROL
Document Number	7000-130
Rev	M
Date	April 1988
Drawn by	R. J. ...

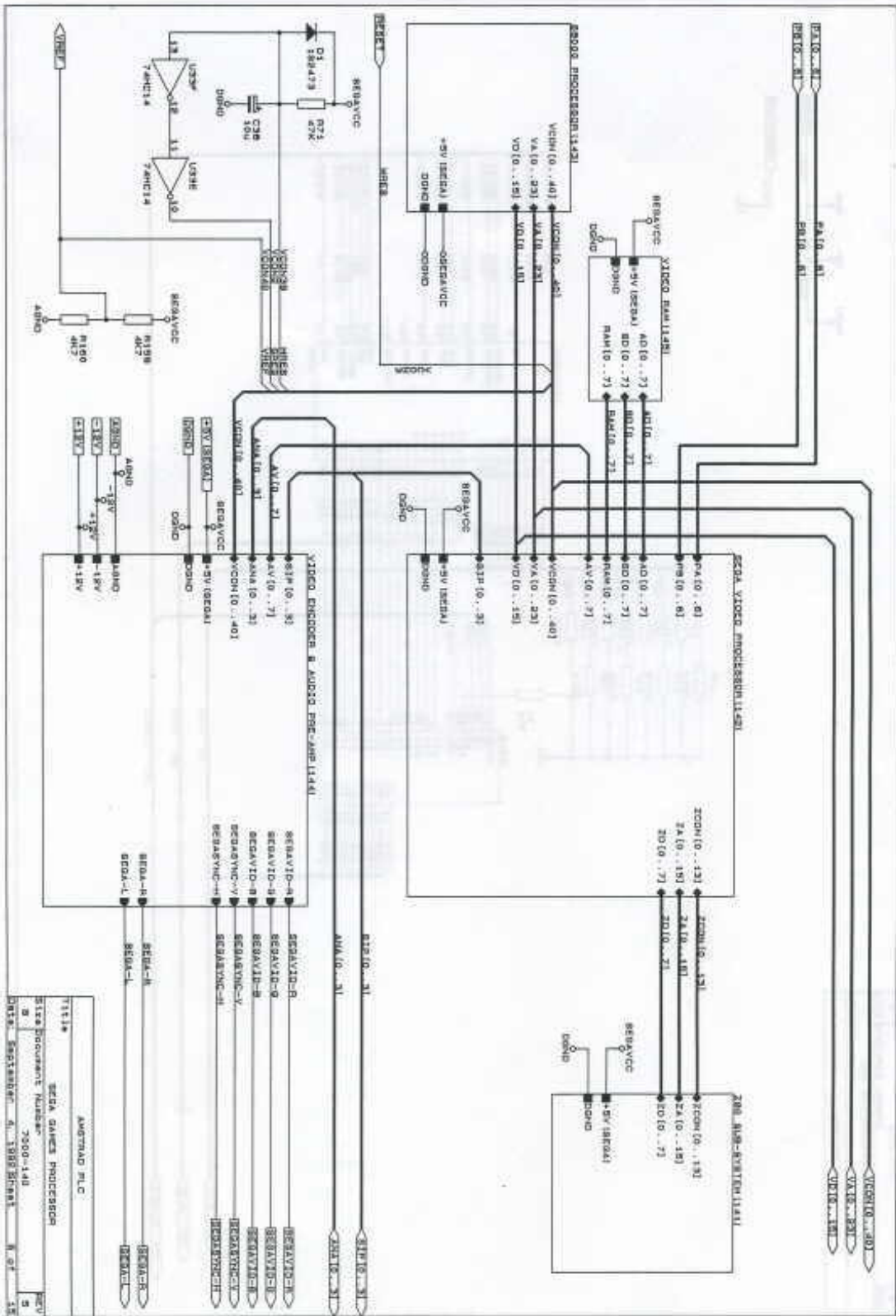

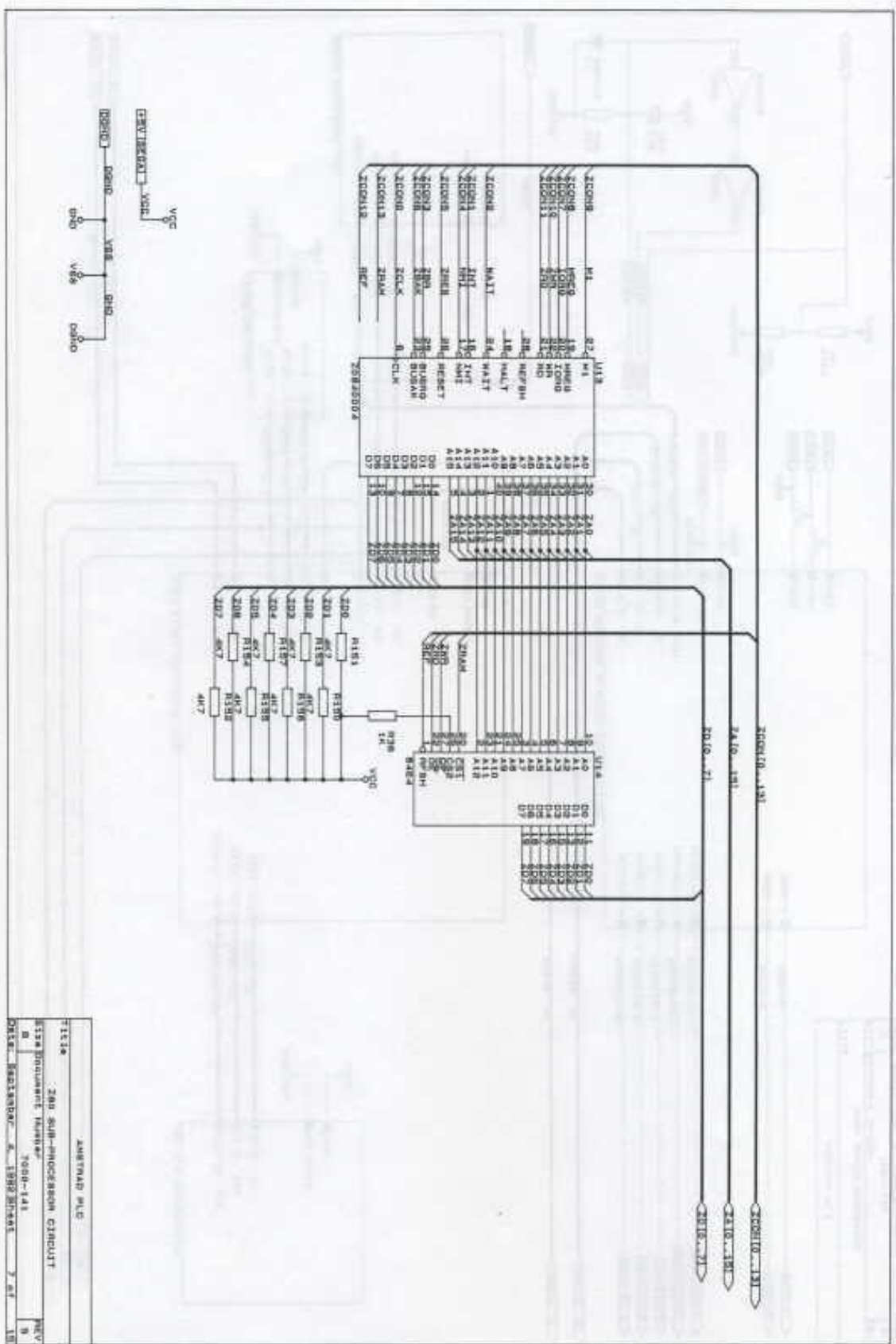

FILE: 280 BIT SHIFTER.CIR
 SHEET: 1 OF 1
 DATE: 1998-11-11 10:00:00
 AUTHOR: 280 BIT SHIFTER

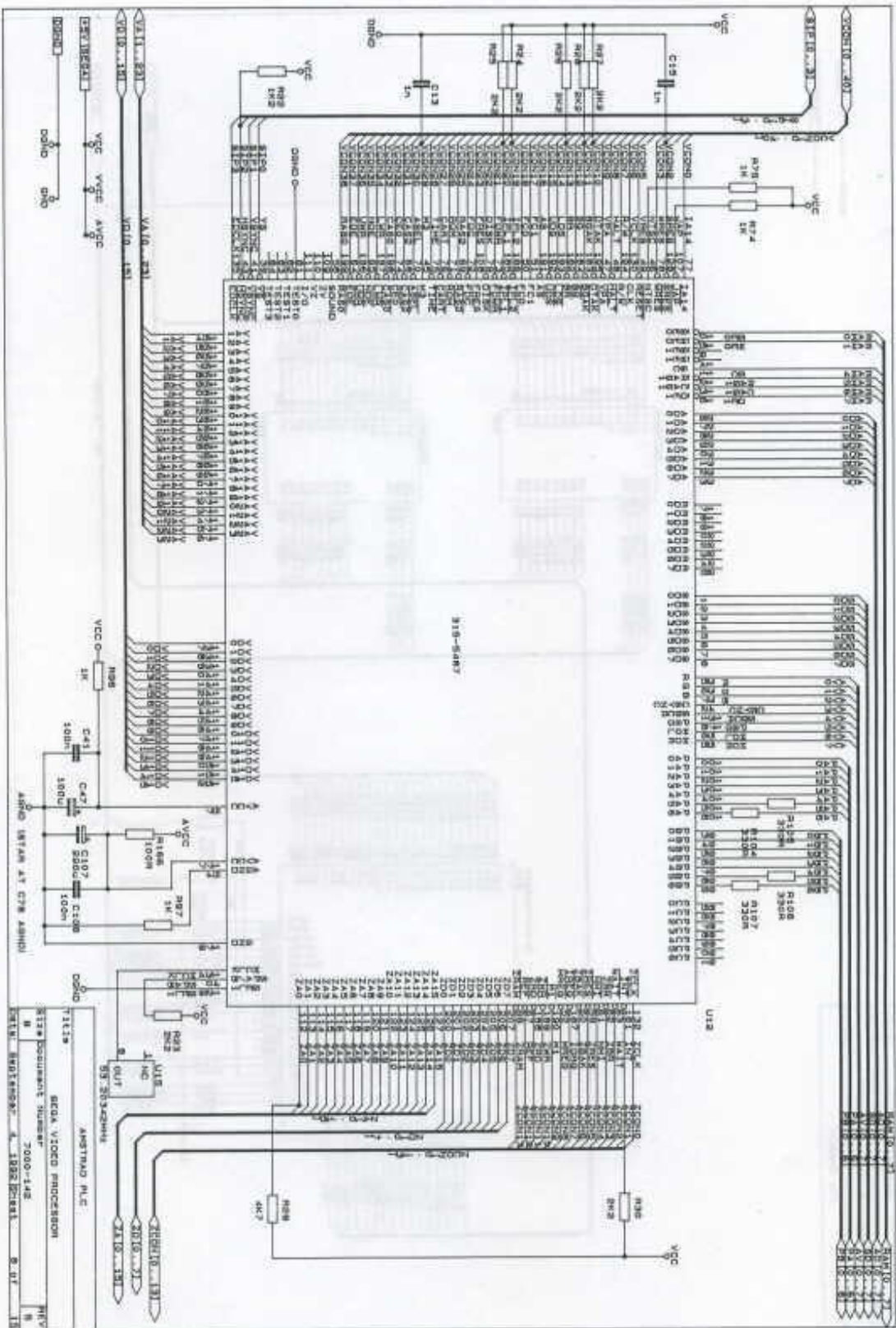

TITLE: BECA VIDEO PROCESSOR
 SIZE: Document Number: 7000-142
 REV: M
 DATE: 11/82
 DRAWN: B. UT
 DESIGNED: S. 1982

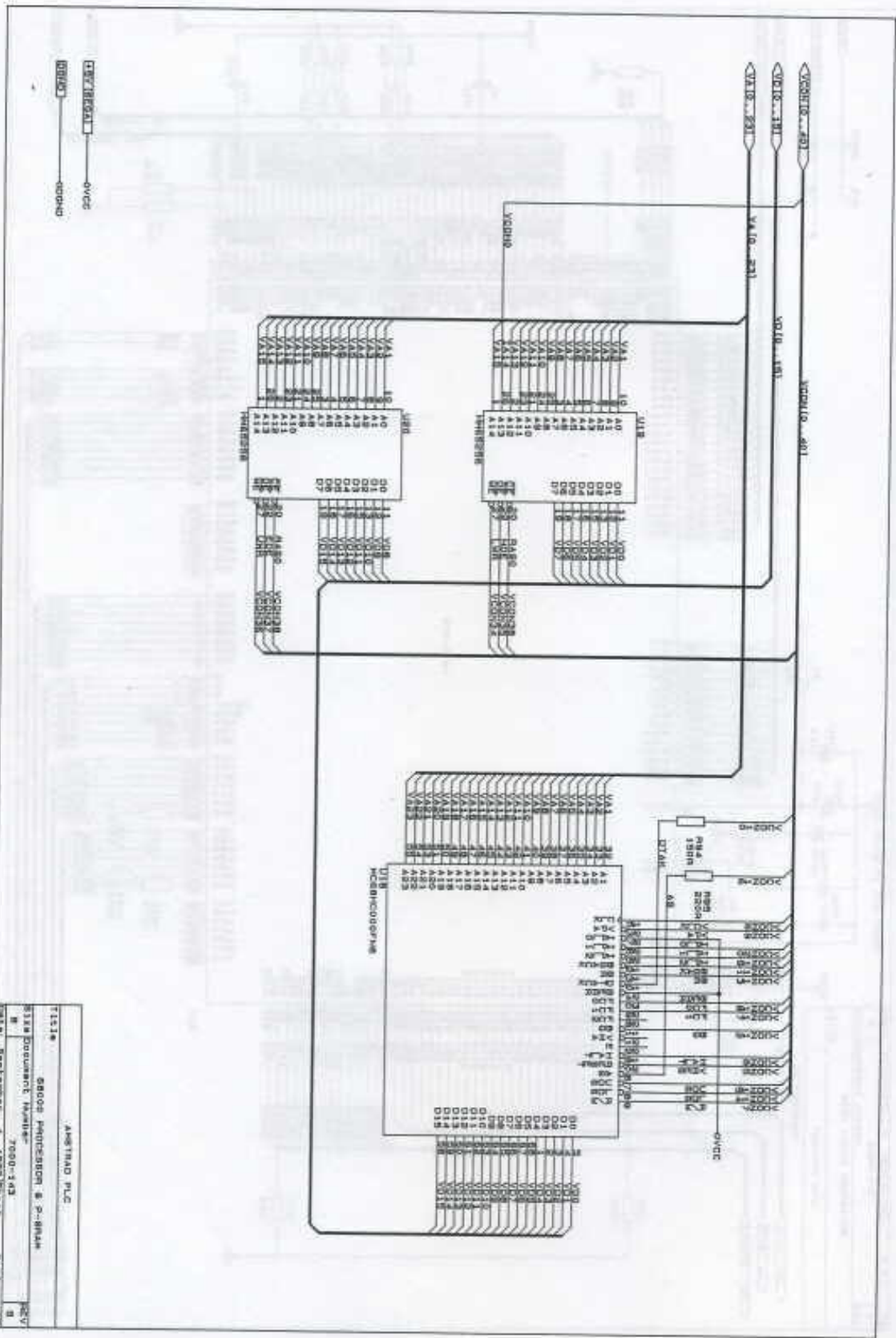

ABSTRAD PLC
 FILE# 58004 PHOTOSECTION 5 P-8944
 Star Document Number 7000-143
 1 1
 2 1
 3 1
 4 1
 5 1
 6 1
 7 1
 8 1
 9 1
 10 1
 11 1
 12 1
 13 1
 14 1
 15 1
 16 1
 17 1
 18 1
 19 1
 20 1
 21 1
 22 1
 23 1
 24 1
 25 1
 26 1
 27 1
 28 1
 29 1
 30 1
 31 1
 32 1
 33 1
 34 1
 35 1
 36 1
 37 1
 38 1
 39 1
 40 1
 41 1
 42 1
 43 1
 44 1
 45 1
 46 1
 47 1
 48 1
 49 1
 50 1
 51 1
 52 1
 53 1
 54 1
 55 1
 56 1
 57 1
 58 1
 59 1
 60 1
 61 1
 62 1
 63 1
 64 1
 65 1
 66 1
 67 1
 68 1
 69 1
 70 1
 71 1
 72 1
 73 1
 74 1
 75 1
 76 1
 77 1
 78 1
 79 1
 80 1
 81 1
 82 1
 83 1
 84 1
 85 1
 86 1
 87 1
 88 1
 89 1
 90 1
 91 1
 92 1
 93 1
 94 1
 95 1
 96 1
 97 1
 98 1
 99 1
 100 1

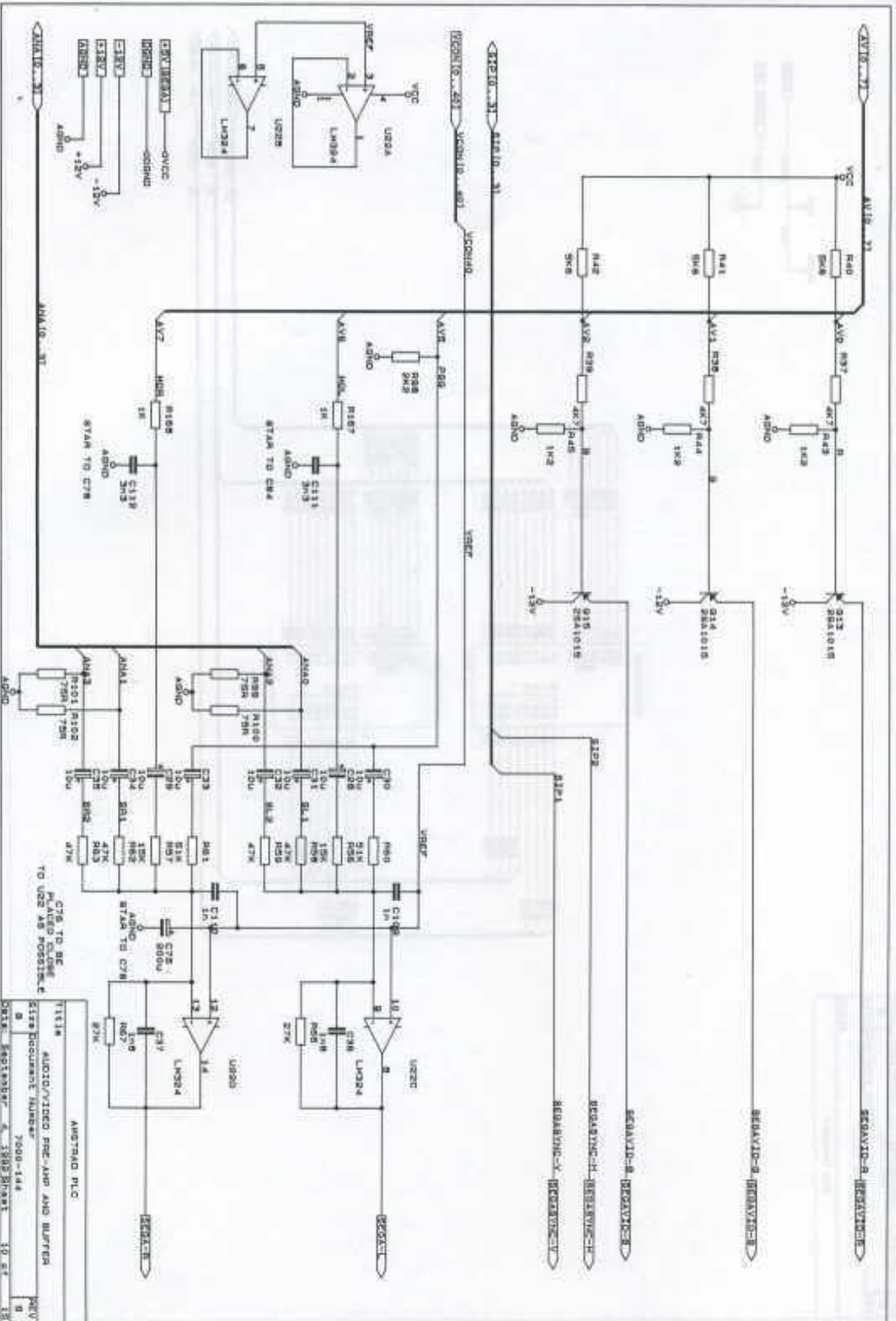

TITLE: AUDIO/VIDEO PRE-AMP AND BUFFER
 SIZE: 1000-144
 DATE: SEPTEMBER 4, 1982 SHEET 10 OF 10

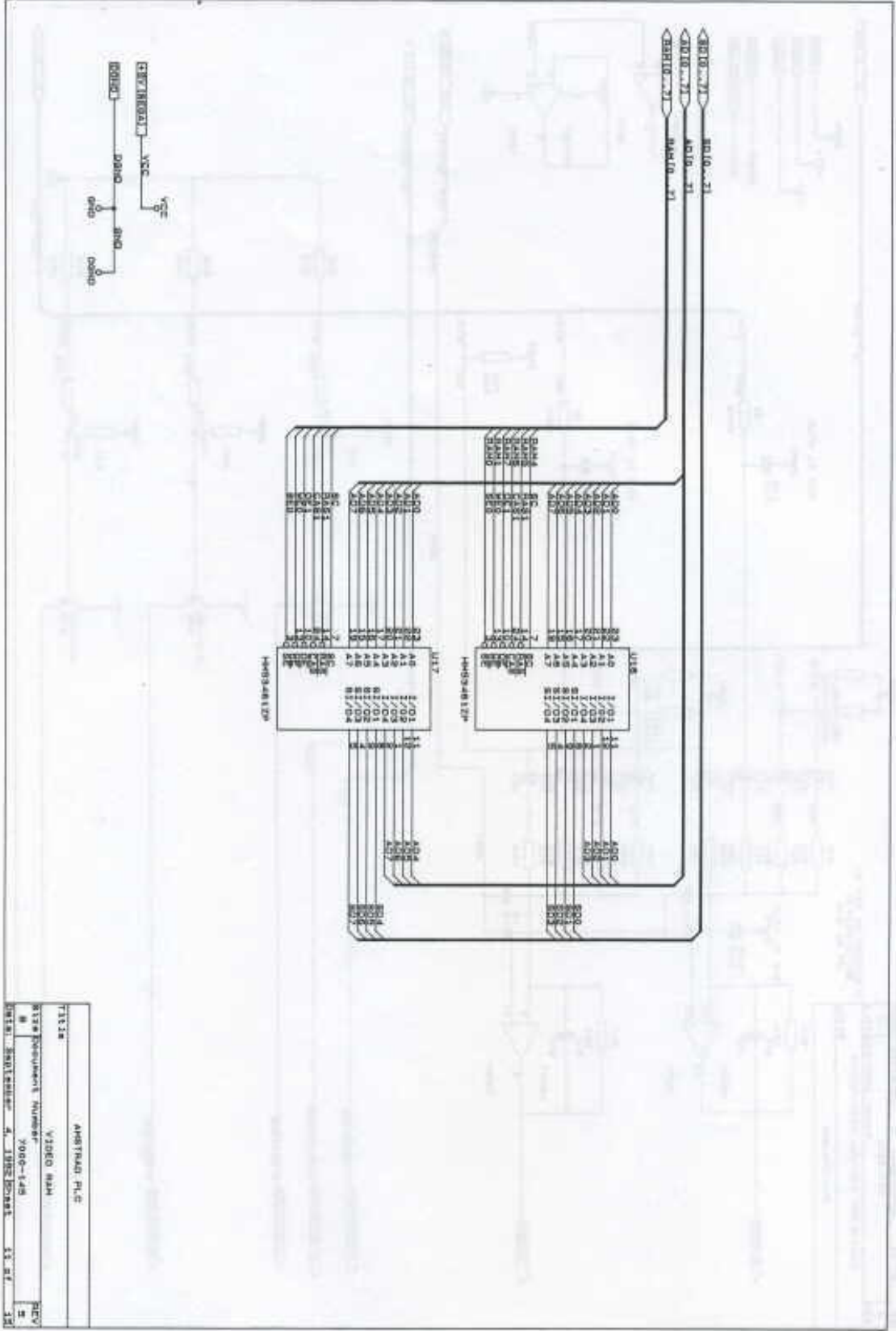

ABSTRACT P.L.C.	
TYPE	V1000 N4H
TYPE Equipment Number	7000-148
REV	1
DATE	APR 1982
DESIGN	11.17

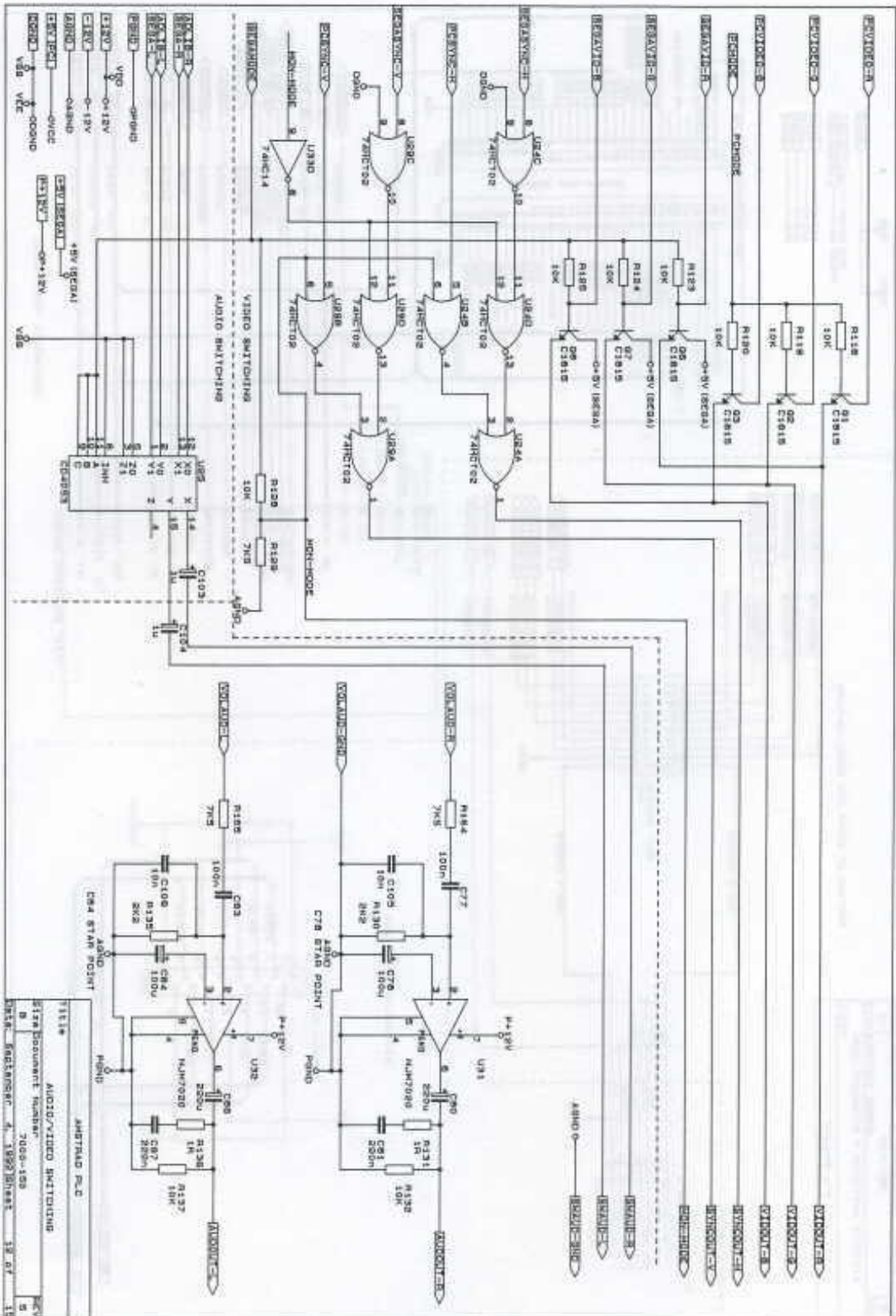

TITLE: AUDIO/VIDEO SWITCHING
 Size: Document Number: 2000-108
 SHEET: 18 OF 18

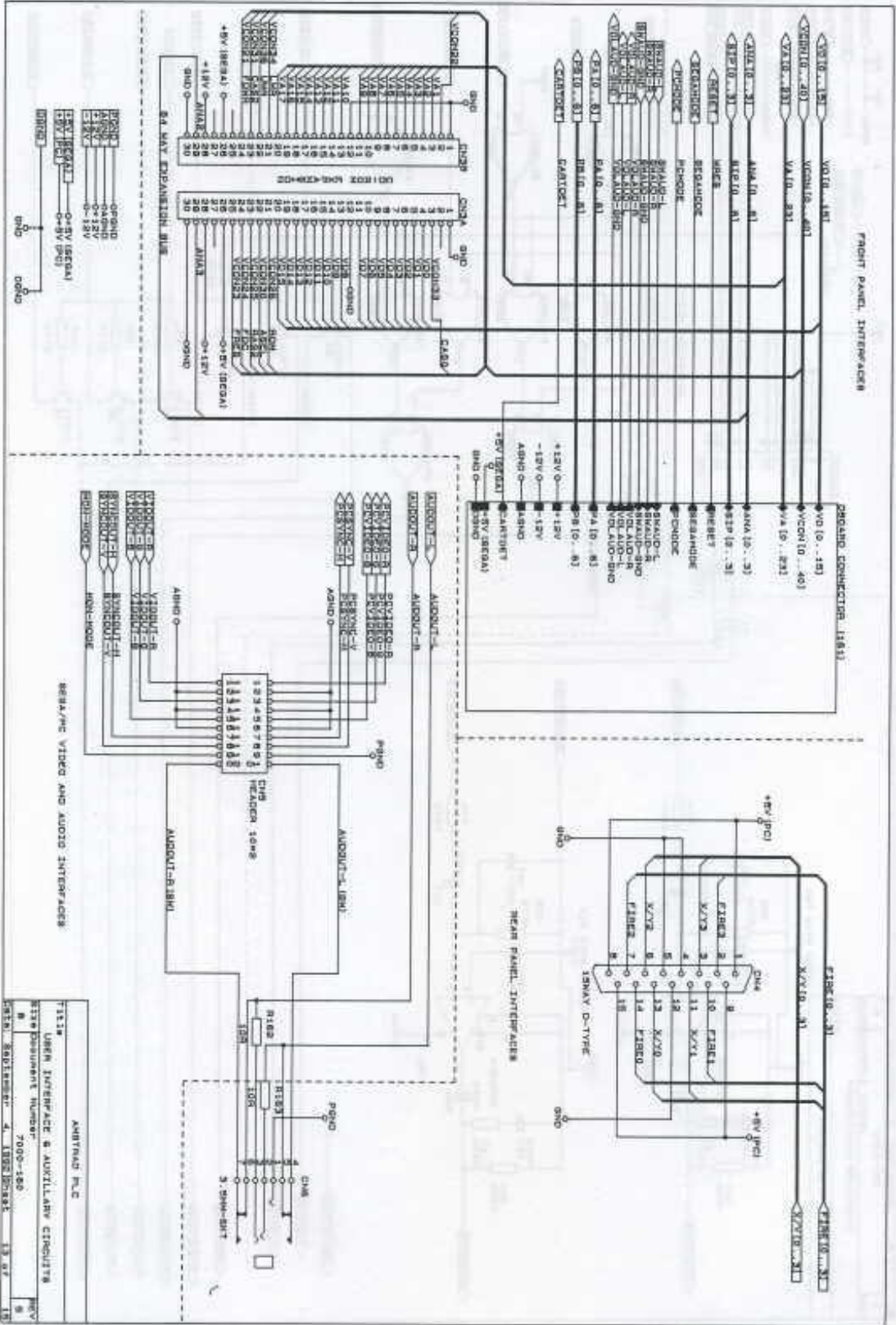

ARMYNAID P.L.C.
 URN INTERFAC & AUXILIARY CIRCUITS
 Site Procurement Number: 7000-180
 REV: 9
 DATE: 2018/01/13 13:07

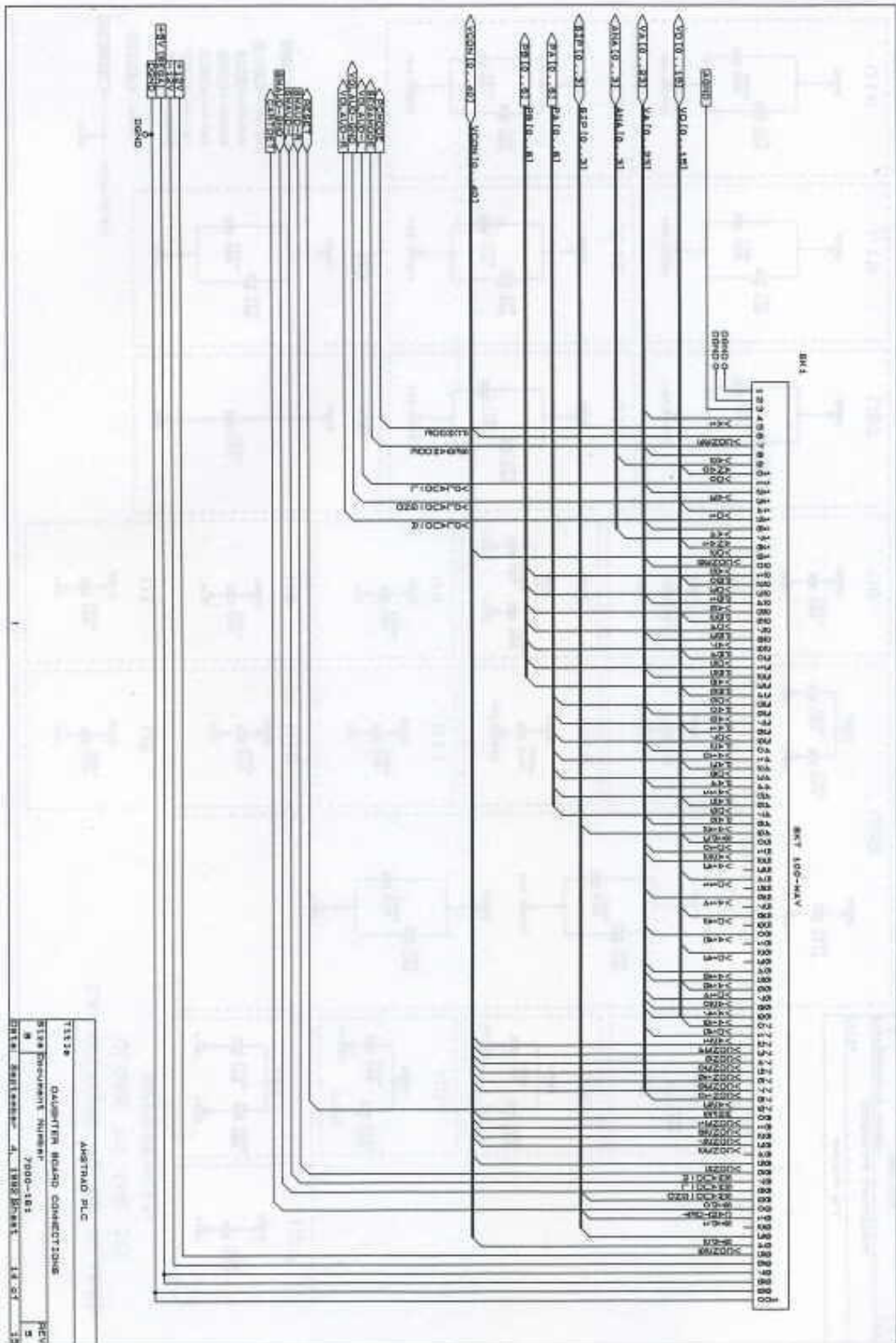

T1318
 DAUGHTER BOARD CONNECTIONS
 7000-181
 REV 1
 DATE 08/15/88
 14 OF 18

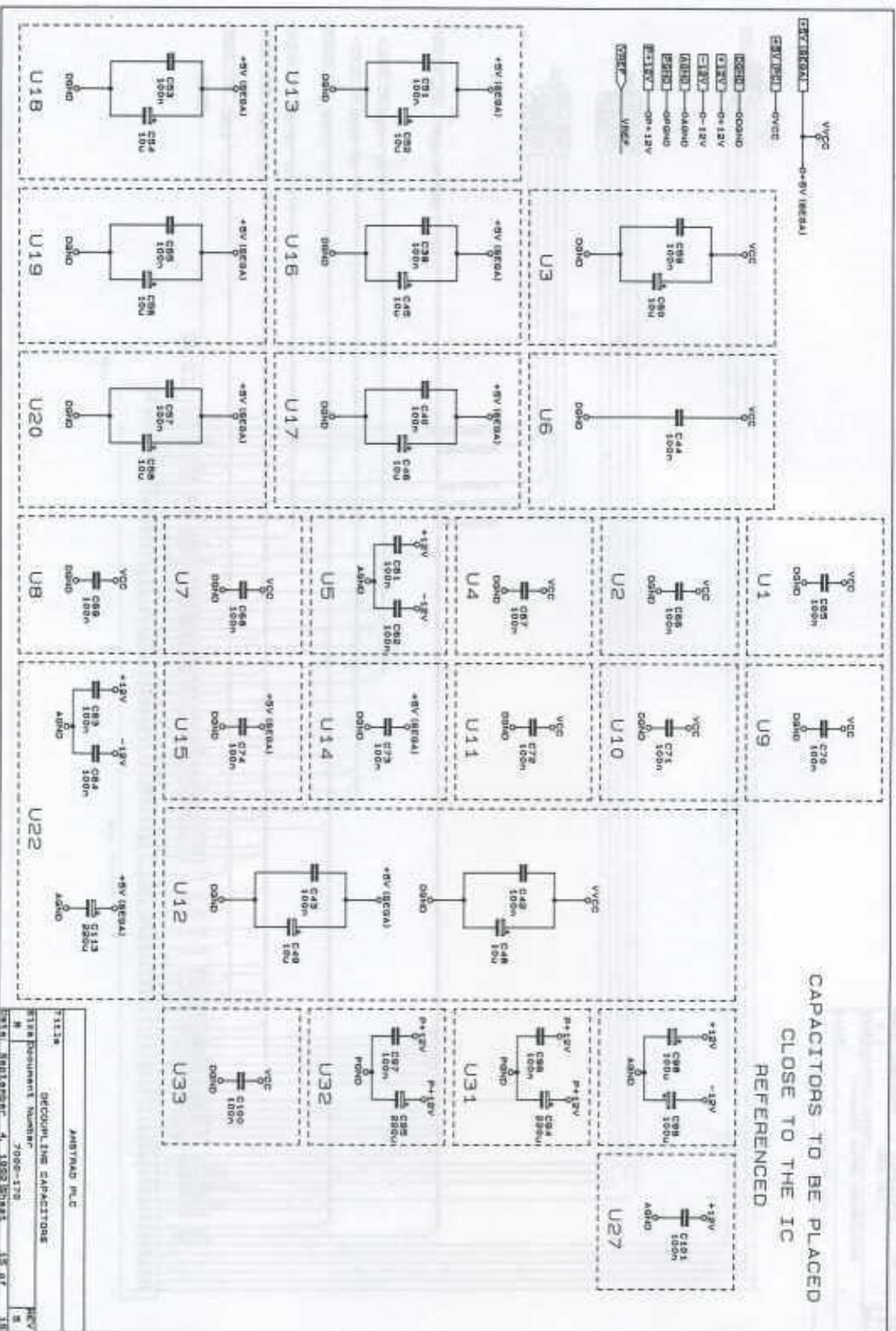

CAPACITORS TO BE PLACED
CLOSE TO THE IC
REFERENCED

7112*	ANIRYAD P.L.C.	REV
DECOUPLING CAPACITORS		1
*SIR Document Number 7000-178		1
SIR, BELLEFOSSE, 4, 1982 STREET		18 OF 18

GAMES CARD TOP VIEW

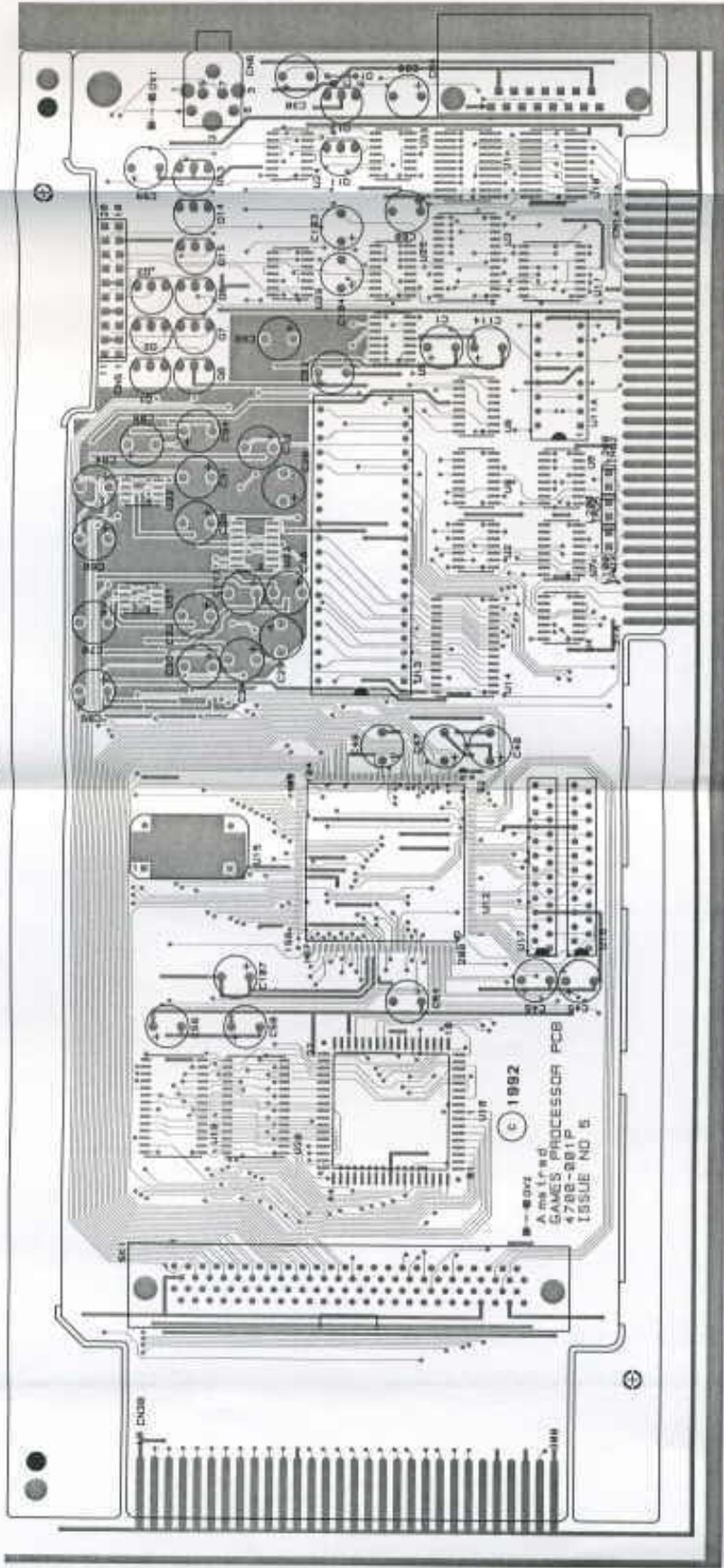

GAMES CARD BOTTOM VIEW

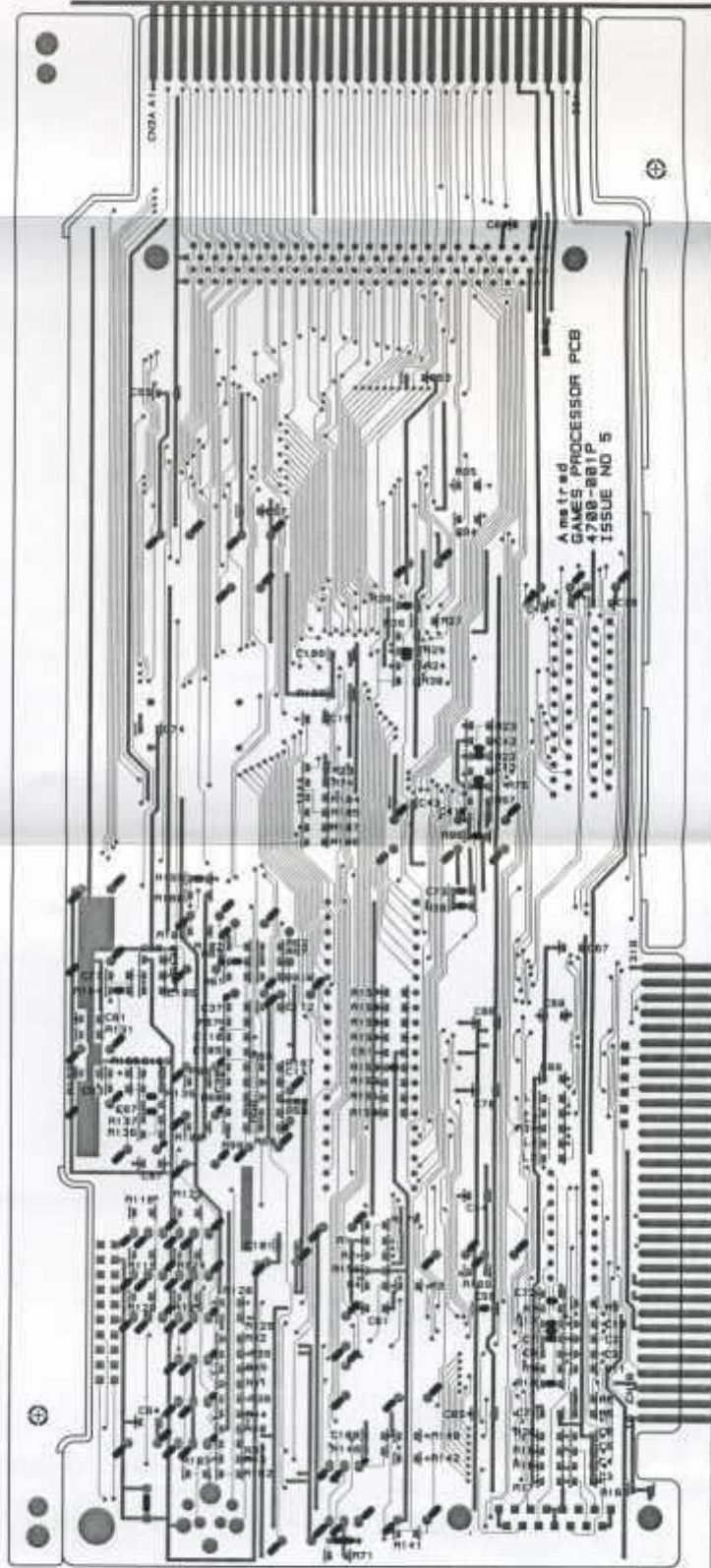

Alignment Procedure

Model : 14" Dual Sync Monitor PC14DSM

1. Preparation

1) Testing Equipment

Amstrad Mega PC & Test Program (KENVGA.EXE)

2) Set monitor so that CRT faces to East and to be safe from abnormal Magnetism.

3) Position of Volume before adjustment

Screen volume : at center
 Brightness volume (VR902) : at center
 Contrast VR (VR901) : at maximum
 Sub contrast VR (VR103) : 1/4 from Minimum
 R Bias VR (R817), G Bias VR (R827), B Bias (R807) : 1/4 from minimum
 Other volumes : at center

2. Adjustment

2-1. H Centering

- 1) Without connecting signal cable
- 2) Adjust screen VR so that RASTER can be seen slightly.
- 3) Adjust S002 (H.RASTER CENT.SWITCH) so that Raster can be at center of the screen.

2-2.H.Hold & H.PHASE

- 1) Connect signal cable
- 2) Get game mode screen from Mega PC (Mode select signal (PIN15) : High)
- 3) Short each side of R502 by 1 F 50V Condenser to break H.Sync.
- 4) Adjust VR508 (H.Hold 1) and position on the point where flow of screen stops.
- 5) Get VGA mode (Mode select Signal (PIN15) : Low)
- 6) Adjust VR509 (H.Hold 2) and position on the point where flow of the screen stops.
- 7) Remove Condenser which is connected to R502.
- 8) Adjust V904 (H Phase) so that data area is at center horizontally
- 9) Adjust V508 (H Hold1) so that screen is at the center after getting Game mode.
- 10) Check if screen is at center after getting VGA mode.

2-3 FOCUS

- 1) Get "H" character screen
- 2) Adjust Focus volume of FBT so that Focus is optimum at B zone.

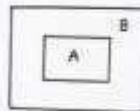

2-4. SIDE PINCUSHION

- 1) Get cross hatch screen of 480 mode.
- 2) Adjust VR434 (Side pincushion) so that left & right of screen is straight.

2-5 V.Linearity

- 1) Get cross hatch pattern at 480 mode
- 2) Adjust VR422 so that vertical cross hatch intervals are same.

2-6. V.Center

- 1) Get cross hatch pattern at VGA 480 mode.
- 2) Adjust VR903 (V.Center) so that screen is at center vertically.

2-7. H.Size

- 1) Get cross hatch pattern at VGA 480 mode.
- 2) Adjust H.Width coil (L504) so that horizontal size is 240 +/-9(mm).
- 3) Adjust VR906 (H.size) to get screen as follow in Game mode. (Game : Space Harrier II)

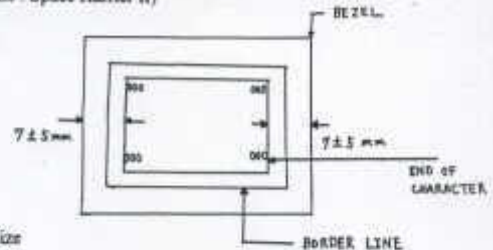

2-8. V.Size

- 1) Get cross hatch screen at VGA 480 mode.
- 2) Adjust VR905 (V.Size 1) so that vertical size is 180 +/-9(mm).
- 3) Get cross hatch screen at VGA 400 mode.
- 4) Adjust VR410 (V.size 2) to get vertical size 180 +/-9 (mm).
- 5) Get cross hatch screen at VGA 350 mode.
- 6) Adjust VR411 (V.size 3) so that vertical size is 180 +/-9 (mm).
- 7) Get game mode (Game : Space Harrier II).
- 8) Adjust VR412 as follow

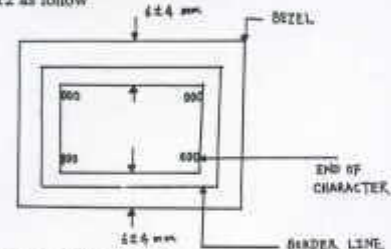

- 9) Check vertical size at all modes again.

2-9 WHITE BALANCE

- 1) Get all black screen at VGA 480 mode
- 2) turn screen VR clockwise until one of R,G,B colours appears.
- 3) Turn Bias volume until colour of screen becomes dark gray
- 4) Adjust screen VR until Raster disappears.
- 5) Get bright white screen at VGA 480 mode.
- 6) Position TV colour Analyzer at center of white screen. Check the axis of X,Y.
 Turn R gain VR (VR121) so that Axis X can be 0.313 +/- 0.03.
 Turn G gain VR (VR131) so that Axis Y can be 0.329 +/- 0.03
- 7) Adjust Contrast VR so that brightness can be 5.0 FT-L.
 Turn R Bias VR (R817) so that X axis can be 0.313 +/- 0.03.
 Turn G Bias VR (R827) so that Y axis can be 0.329 +/- 0.03.
- 8) Turn contrast VR and check if Axis X,Y are within spec. If not, repeat 6),7).
- 9) Get cross hatch screen at VGA 480 mode and turn contrast VR at maximum. Turn SUB Brightness VR (VR961) until Raster disappears.
- 10) Get Bright white screen at VGA 480 mode, check if brightness is over 100 NIT (29Ft-L). If not, adjust Sub contrast VR (VR103).

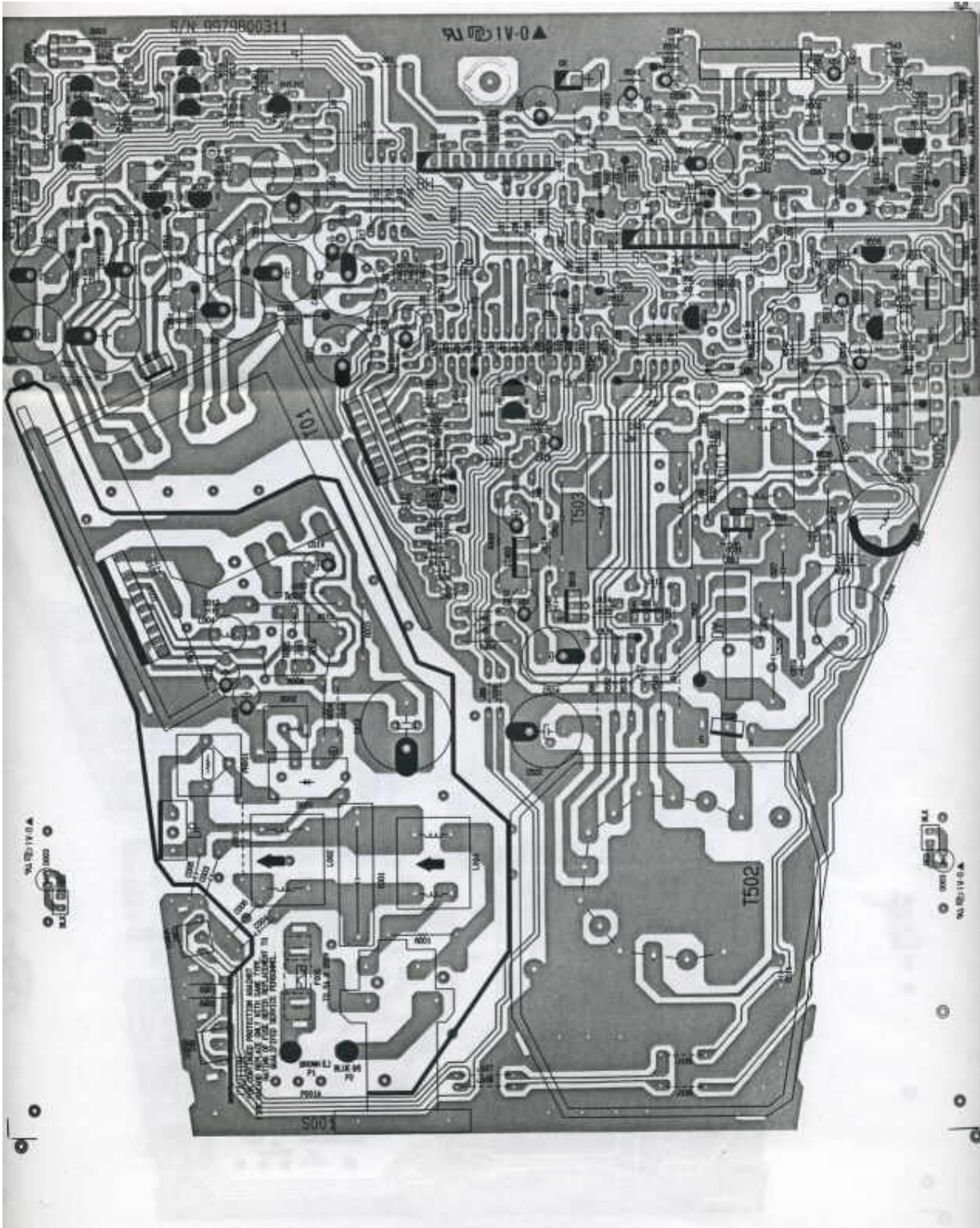

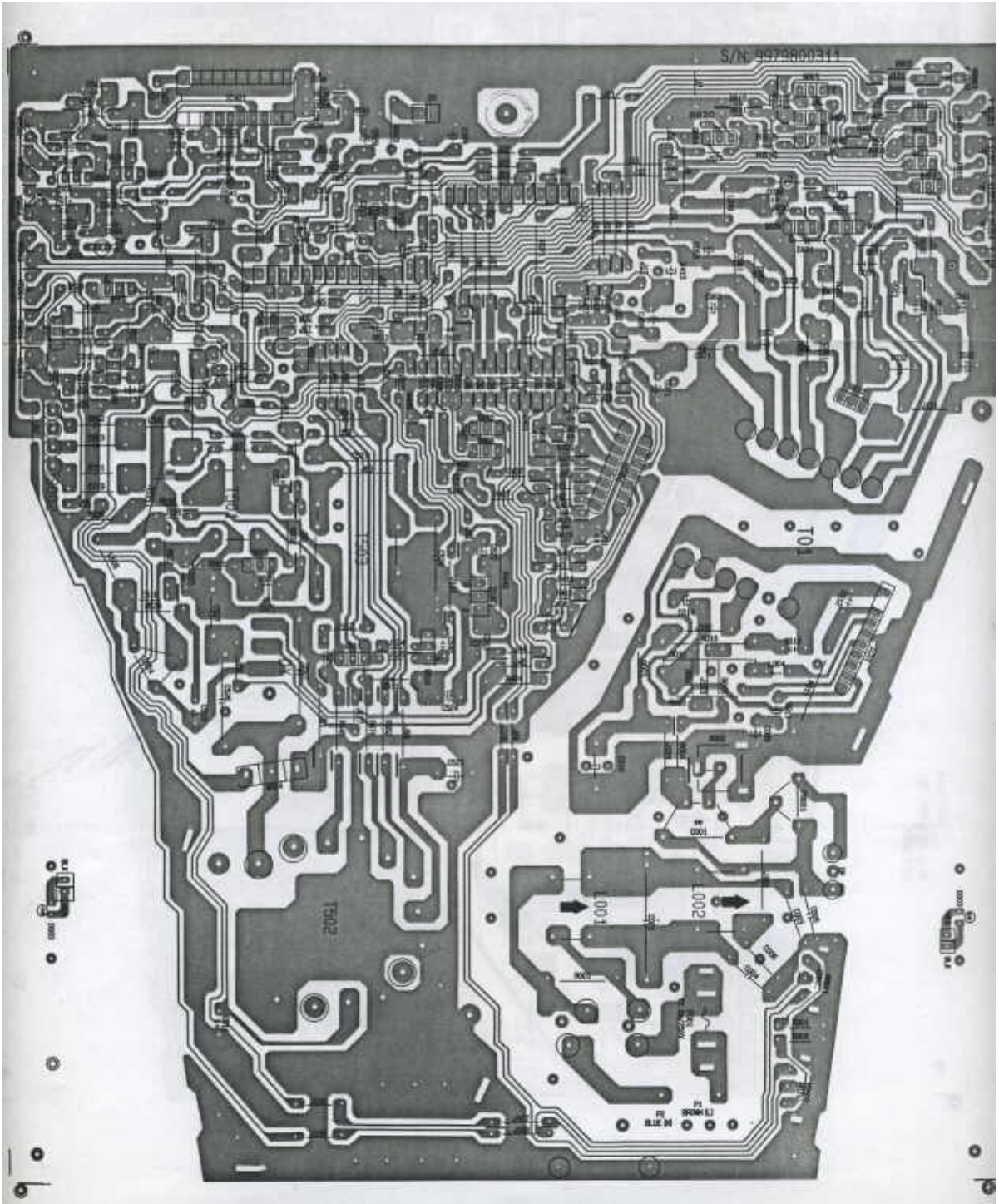

S/N 9979800311

T01

T002

L001

L002

IN 27.0
IN 28.0
IN 29.0
IN 30.0

AUDIO PCB TOP VIEW

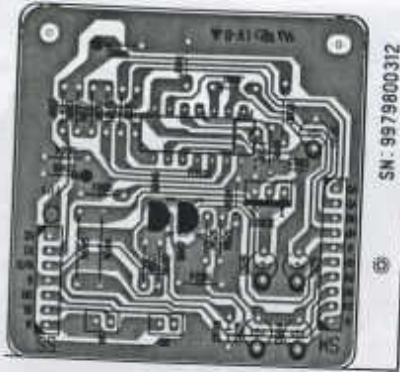

AUDIO PCB BOTTOM VIEW

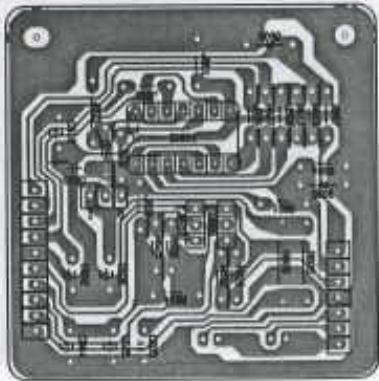

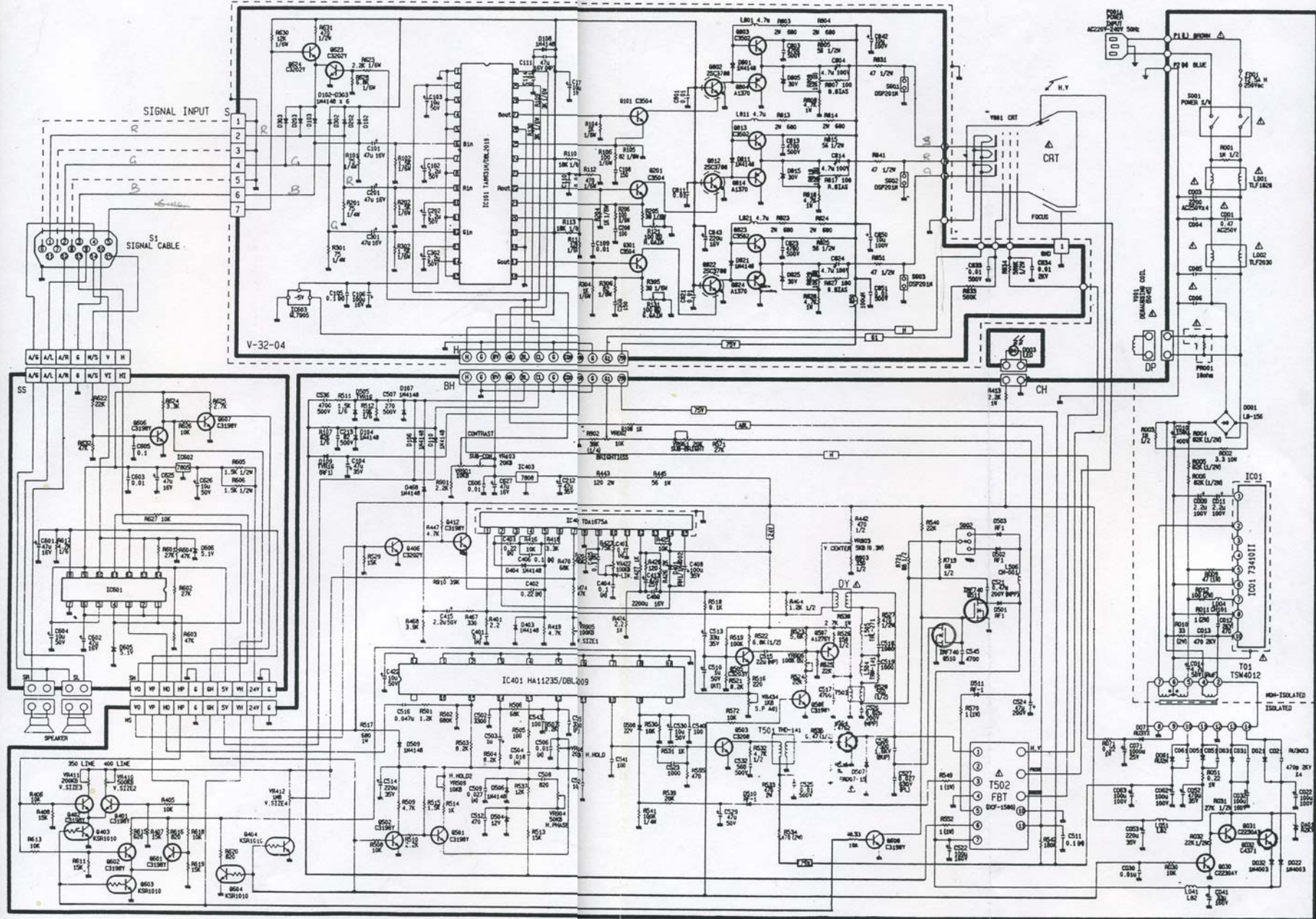

MAIN SCHEMATIC DIAGRAM

CABINET EXPLODED VIEW

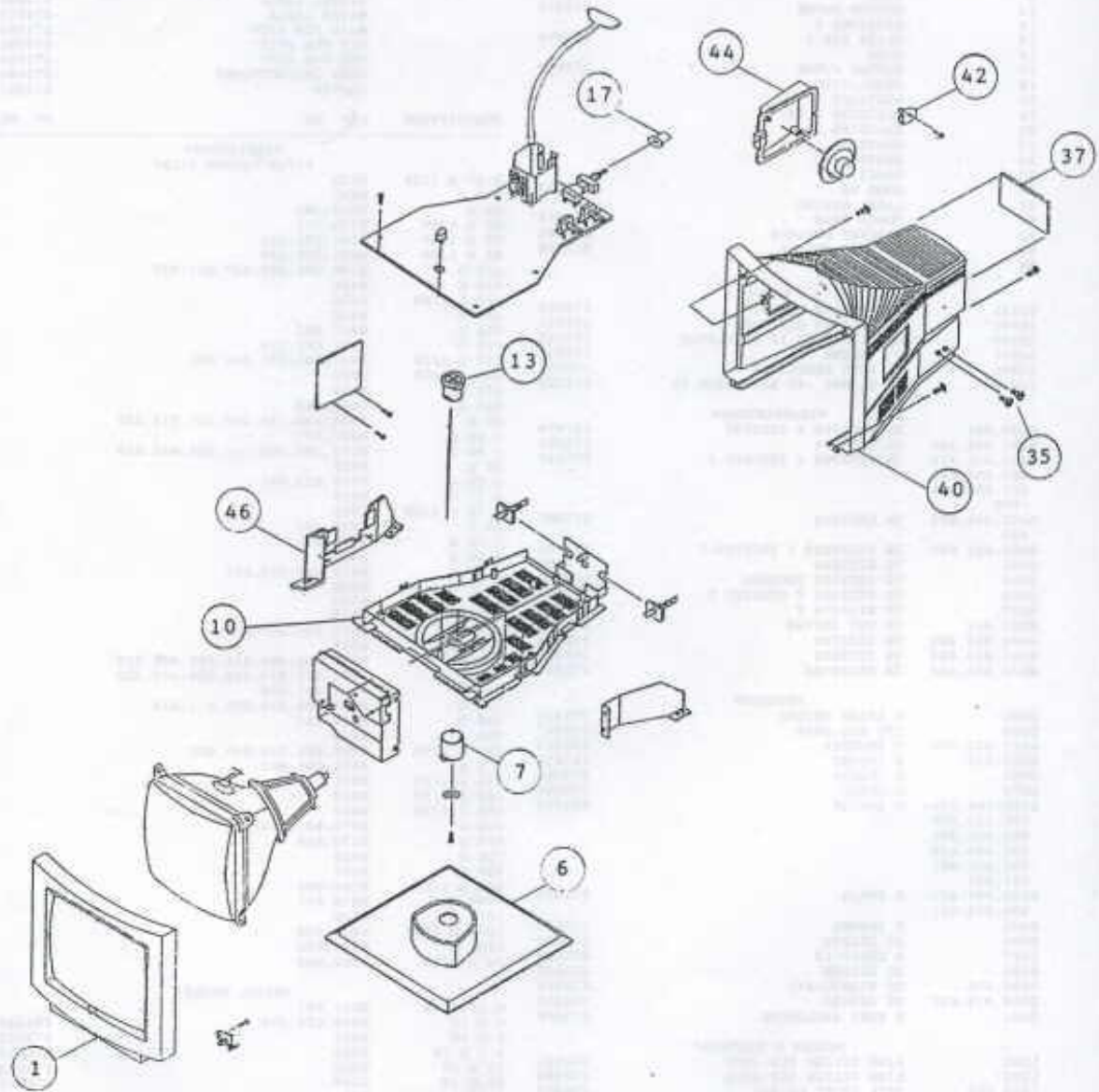

PC14DSM.

REF. NO.	DESCRIPTION	PT. NO.
CABINET PARTS LIST		
1	COVER FRONT	272973
2	SCREW CRT MOUNTING	
3	RUBBER WASHER	
4	BRAND INLET	
5	BASE STAND	272589
6	SLIDE PAD B	272978
7	SCREW TAPTITE 4X14MFXH	
8	FOOT	272982
9	BOTTOM COVER	273975
10	RETAINER B	
11	SLIDE PAD A	272978
12	BUSH	
13	SLIDE PAD A	272978
14	BUSH	
15	SLIDE PAD B	272978
16	BUSH	
17	BUTTON POWER	273977
18	INSULATION	
19	HEATSINK A	
20	HEATSINK C FBT	
21	HEATSINK B	
22	HEATSINK D	
23	HEATSINK A	
24	HEATSINK B	
25	HEATSINK C	
26	HEATSINK D	
27	HEATSINK A	
28	HEATSINK B	
29	HEATSINK C	
30	HEATSINK D	
31	SHAFT	
32	KNOB VR	273978
33	LABEL RATING	
34	COVER REAR	273974
35	BRACKET SPEAKER	273995
36	SPEAKER HOLDER	273996
37	SUPPORTER L	
ICS		
IC101	IC T8831F DBL2018	175348
IC401	IC DBL2009 HA11235	175346
IC403	IC GL7908 8V 1A REGULATOR	175323
IC801	IC 74LS86 TTL	175935
IC802	IC 7805 REGULATOR	190731
IC803	IC GL7905 -5V REGULATOR 1A	272124
TRANSISTORS		
Q030.031	TR KTC1025 Y 2SC2230	241578
Q101.201.301	TR 2SC3804	175354
Q401.402.412	TR KTC3198 Y 2SC1815 Y	170447
501.502.506		
601.602.606		
-608		
Q403.404.503	TR K8H1010	273997
604		
Q406.623.624	TR KTC3202B Y 2SC1959 Y	272602
Q503	TR KTC3208	273998
Q504	TR 2SC4762 2SC3882	273999
Q505	TR KTC3203 Y 2SC2120 Y	272603
Q507	TR KTA1278 Y	274000
Q510.511	TR FET 1BF740	274001
Q802.812.822	TR 2SC3788	272598
Q803.813.823	TR 2SC3502	175352
Q804.814.824	TR 2SC1370E	272997
DIODES		
D001	D 1N156 BRIDGE	272610
D003	LED KLG-COSE	175327
D021.031.051	D 1N56H45	274003
D022.032	D 1N4003	187856
D061	D 1S1834	274002
D071	D BUZYX	274004
D102-104.106-108.110.203	D 1N4148	270754
203.302.303		
403.404.408		
506.509.801		
811.821		
D109.501-503	D TVN1G	274005
505.510.511		
D401	D 1N4002	175943
D504	DZ D212MB	272905
D507	D ERD07-15	272608
D508	DZ D222BM	272506
D605.606	DZ BZX83C-5V1	272604
D806.815.825	DZ D2398M	272607
DA01	D R2KY AVALANCHE	274006
COILS & FILTERS		
L001	LINE FILTER TLF-1828	272983
L002	LINE FILTER TLF-2030	272984
L004.850	COIL CHOKE CN-101	274007
L041.051	COIL CHOKE L-82	274008
L504	COIL N LINEARITY TBL-271	274009
L505	COIL WIDTH TRW-141	274010
L508	COIL CHOKE CR-001	274011
L801.811.821	COIL PEAKING 4.7UH	272991
VARIABLE RESISTORS		
VR103.508.961	VR5F 20K Q 1203	272620
VR121.131	VR5F 100 Q 1101	272613
VR410	VR5F 500K Q 1504	272620
VR411	VR5F 200K Q 1204K	272617
VR412	VR5F 1M Q 1105 0.1W	274012
VR422.905.906	VR5F 100K Q 1104	272615
VR434	VR5F 1K Q 1102	272621
VR809	VR5F 10K Q 1103	272622
VR801	VR0T 10KB Q 3016B	272624
VR802	VR0T 10KB Q 3017B	272624
VR803	VR5F 5K Q 15023 0.3W	272618
VR804	VR5F 50K Q 5X2.5 1803	272619
VR809.819.829	VR5F 10K Q 1102M EVN49C	272622

DESCRIPTION	REF. NO.	PT. NO.
MISCELLANEOUS		
F001	FUSE TL 3.5A 250V	202251
PR001	POSISTOR PTH451C26	272993
S001	SW POWER PUSH WE-4A	272979
S002	SW LEVER P12T21	272994
T01	TX-SMPS TSW-4012	273987
T501	TX H DRIVE THD-141	273988
T502	TX FBT DCF-1580 E	273990
T503	TX SPC TPC-141	274013
V001	COIL DEGAUSS 5045	272985
V801	CRT M34NRM2X13	273982
	SPEAKER 3" 8Q	274014
S001-03	SURGE PROTECTOR ODSP-201M-S008	274015
V801C	CRT SOCKET S008628	272594
	SIGNAL CABLE	273989
	WAISS CABLE	274016
	MAIN PCB ASSY	273983
	CRT PCB ASSY	273985
	SUB PCB ASSY	273984
	USER INSTRUCTIONS	273980
	CARTON	273981

DESCRIPTION	REF. NO.	PT. NO.
RESISTORS		
1/GW CARBON FILM		
0.47 Q 1/2W	R535	
2.2 Q	R401	
39 Q	R200.305	
68 Q 1/2W	R719.721	
75 Q 1/4W	R101.201.301	
82 Q 1/6W	R105.306.536	
100 Q	R106.206.505.807.817.827	
120 Q	R428	
150 Q 1/2W	R526	
220 Q	R816	
330 Q	R467.903	
470 Q	R112.442.555	
470 Q 1/2W	R527.631.831.841.851	
560 Q 1/2W	R528	
620 Q	R615	
820 Q	R616.520	
1K Q	R104.108.204.304.427.514.531	
1.5K Q	R604.501	
1.5K Q	R102.202.302.511.515.605.606	
2K Q	R426	
2.2K Q	R510.623.801	
2.7K Q	R825	
2.7K Q 1/2W	R522	
3K Q	R109.130	
3.3K Q	R419.624	
3.9K Q	R468	
4.7K Q	R419.447.509.617	
4.7K Q 1/2W	R532	
5.6K Q	R523	
6.8K Q	R628	
8.2K Q	R503.504.507.521	
9.1K Q	R618	
10K Q	R030.405.406.416.425.508.512.520.572.612.618.626.627.833	
12K Q	R114.537.830	
15K Q	R407.408.513.529.611.618	
18K Q	R110.113	
20K Q	R538	
22K Q 1/2W	R032.524.525.540.622	
27K Q	R571.601.602	
27K Q 1/2W	R031	
39K Q 1/4W	R910	
39K Q 1/4W	R907	
47K Q	R474.603.604.632	
68K Q	R470.506	
75K Q	R423	
82K Q	R107	
82K Q 1/2W	R004-006	
100K Q	R519.541	
180K Q	R542	
560K Q 1/4W	R833.834	
680K Q	R420.502	
1M Q 1/2W	R001.003	

DESCRIPTION	REF. NO.	PT. NO.
METAL OXINE		
0.22 Q 1W	R051.071	
1 Q 1W	R545.552.570	175925
1 Q 2W	R011	273003
2.2 Q 1W	R424	274018
33 Q 2W	R010	170411
47 Q 1W	R009	176548
56 Q 1/2W FP	R805.815.825	193413
56 Q 1W	R445	
100 Q 2W	R012	176744
120 Q 2W	r443	
470 Q 2W	R533.534	273004
680 Q 1W	R517803.804.813.814.823.824	274010
2.2K Q 1W	R413	274017
2.7K Q 1W	R538	
4.7K Q 1W	R800.818.828	273002
CEMENT		
3.3 Q 10W	R002	274025
CAPACITORS		
CERAMIC		
82pF 500V	C213	273005
100pF	C208.540-542.801	
120pF	C308	
150pF	C108	
270pF 500V	C507	175345
470pF	C512	

470pF 2KV	G012,013,021,021,051,061	176751
560pF 500V	C532	175876
820pF	C508	
1000pF 500V	C518,519,523	
2200pF 250VAC	IC003-006	
4700pF	C606	
4700pF 500V	CS17,536,803,813,823	175981
0.01uF	G030,109,110,114,602,821	
0.01uF 500V	CS25,606,811,833,851	175886
0.01uF 2KV	CR34	272464
0.1uF	CR05	
Line Across		
0.47uF 250VAC	IC001	194214
ELECTROLYTIC		
1uF 50V	CS03,510	
2.2uF 50V	C102,202,302,415	
2.2uF 100V	C009,011	
4.7uF 50V	C014	
4.7uF 100V	CR04,814,824	
10uF 50V	C103,422,530,626	
10uF 100V	CR42,850	
22uF 16V	CS16	
33uF 35V	CS13	
33uF 160V	C041	
47uF 16V	C101,111,201,601,.602,625,627	
47uF 25V	C413	
47uF 35V	C104,212	
47uF 50V	C529	
47uF 200V	C524	
100uF 16V	C106,117	
100uF 35V	C408	
100uF 100V	C022,062,063	
100uF 160V	C032,522	
150uF 400V	C010	
220uF 16V	CR43	
220uF 35V	C053,514	
470uF 35V	C052	
1000uF 25V	C071	
2200uF 16V	C409	
MYLAR		
3300pF	CS02,505	
7500pF 1.6KV	CS26	
0.01uF	CS06	
0.018uF	CS04	
0.027uF	CS03	
0.027uF 630V	CS27	
0.047uF	CS16	
0.1uF	C105401,404-407,511	
0.22uF	C4,2,4,3	
0.47uF 200V	CS21	
0.82uF 200V	CS20	

CAUTION!

Danger of explosion if battery is incorrectly replaced.
Replace only with the same or equivalent type
recommended by the equipment manufacturer. Discard
used batteries according to manufacturer's instructions.

ADVERSE!

Lithiumbatteri – Eksplosionsfare ved fejlagtig håndtering.
Udskiftning må kun ske med batteri af samme fabrikat og
type. Levér det brugte batteri tilbage til leverandoren.

VAROITUS!

Paristo voi räjähtää, jos se on virheellisesti asennettu.
Vaihda paristo ainoastaan laite-valmistajan suosittelemaan
tyyppiin. Hävitä käytetty paristo valmistajan ohjeiden
mukaisesti.

ADVARSEL!

Lithiumbatteri – Eksplosjonsfare. Ved utskifting benyttes
kun batteri som anbefalt av apparatfabrikanten. Brukt
batteri returneres apparatleverandoren.

WARNING!

Explosionsfara vid felaktigt batteribyte. Använd samma
batterityp eller en ekvivalent typ som rekommenderas av
apparatillverkaren. Kassera använt batteri enligt
fabrikantens instruktion.