

AMSTRAD

PERSONAL COMPUTER

PC1640



User Instructions



PLC

Tree

Tree / F -> PRM
or Global DIR / W -> PRM

1/W G.D.P.S \015~ Condensed print. Macro
cccc

AMSTRAD PC USER MANUAL

Copy - Filename - PRM

Batch file

Copy con - Name - BAT

F6 to end.

©Copyright 1987, AMSTRAD plc and Locomotive Software Ltd

Neither the whole nor any part of the information contained herein, nor the product described in this manual may be adapted or reproduced in any material form except with the prior written approval of AMSTRAD plc ('AMSTRAD').

The product described in this manual and products for use with it are subject to continuous development and improvement. In particular, there may be differences between the messages displayed on your screen and those shown here.

All information of a technical nature and particulars of the product and its use (including the information and particulars in this manual) are given by AMSTRAD in good faith. However, it is acknowledged that there may be errors or omissions in this manual.

AMSTRAD welcomes comments and suggestions relating to the product or this manual.

All correspondence should be addressed to: Customer Services

AMSTRAD plc
Brentwood House
169 Kings Road
Brentwood
Essex CM14 4EF
Tel: (0277) 230222

01277-236100

All maintenance and service on the product must be carried out by AMSTRAD authorised dealers. AMSTRAD cannot accept any liability whatsoever for any loss or damage caused by service or maintenance by unauthorised personnel. This manual is intended only to assist the reader in the use of the product, and therefore AMSTRAD shall not be liable for any loss or damage whatsoever arising from the use of any information or particulars in, or any error or omission in, this manual or any incorrect use of the product.

Written by Jean Gilmour, Locomotive Software, revised for PC1640 by Des Gallivan including material by Rupert Goodwins and Roland Perry.

Published by AMSTRAD

First Published 1986
Revised for PC1640 1987
Second Edition 1987

GEM, GEM Desktop, GEM Draw, GEM Paint, DOS Plus, CP/M and CP/M-86 are trademarks of Digital Research Inc
MS-DOS® is a registered trademark of Microsoft® Corporation
IBM is a registered trademark of International Business Machines Corp
Wordstar is a trademark of MicroPro International Corporation
1-2-3 and Lotus are trademarks of Lotus Development Corp
VT52 is a trademark of Digital Equipment Corp
Locomotive BASIC 2 and Mallard BASIC are trademarks of Locomotive Software Ltd
AMSTRAD PC, PCW8256, PCW8512, CPC464, CPC 664 and CPC6128 are trademarks of Amstrad plc

AMSTRAD is a registered trademark of AMSTRAD plc
Unauthorised use of the trademark or word AMSTRAD is strictly forbidden

Preface

The PC1640 is designed to operate with a wide range of software described, for example, as 'for the IBM PC and Compatibles' or 'for the Amstrad PC and Compatibles'.

The PC1640 is available with a choice of three displays. Having made your choice of display, this preface is intended to help you understand what software you can now use. The differences between the displays can be expressed as the number of colours and dots they are capable of showing. More dots give better quality text and graphics (pictures, graphs etc).

Unfortunately, some software is not capable of displaying graphics on the PC MD display, or of using the higher resolution capabilities of the PC ECD display. You should check carefully with your dealer regarding the availability of software for your particular display. Sometimes the software will adapt to your display automatically. Sometimes you will be required to install the software (tell the software what display you have), before you use it; in this case you may have to re-install the software if you subsequently use it on a PC with a different display.

Software which never uses graphics ('text only' software) will normally operate automatically on all displays, but some will still require installing. You should consult the instructions supplied with the software.

GEM software, which uses windows, icons and the mouse, will operate perfectly on all displays. The software automatically adjusts to the number of colours and dots on the screen.

Here is a simple summary of the capabilities of each display, and some jargon words you may encounter when installing software:

PC MD Black and white. 252000 dots (720×350).

Tell your software that you have a 'Monochrome Display Adapter (MDA)' or 'Monochrome Monitor' or 'Hercules Graphics Card' or 'Enhanced Graphics Adapter (EGA) with Monochrome Monitor'.

PC CD Up to 16 colours, 128000 dots (640×200) &
2 colours, 128000 dots (640×200) &
4 colours, 64000 dots (320×200)

Tell your software that you have a 'Colour Graphics Adapter (CGA)' or 'Colour Monitor' or 'Enhanced Graphics Adapter (EGA) with Standard Colour Monitor'.

PC ECD Up to 16 colours (chosen from 64), 224000 dots (640×350) &
16 colours, 128000 dots (640×200) &
2 colours, 128000 dots (640×200) &
4 colours, 64000 dots (320×200)

Tell your software that you have an 'Enhanced Graphics Adapter (EGA) with Enhanced Monitor', or any of the options shown for the PC CD display above.

You cannot use software specially designed for the PC1512 extra high resolution graphics on any PC1640 display. Other PC1512 graphics software will normally operate with both the PC1640 CD and ECD displays. GEM software or 'text only' software for the PC1512 will normally operate on all PC1640 displays.

INTRODUCTION

The AMSTRAD PC is a powerful 16-bit personal computer, which you can use both in the office and in the home. For example, it could help you to prepare letters or to carry out routine office tasks at work, it could help you budget ahead and so keep in credit at the bank, and it can run computer games when you want to relax.

The AMSTRAD PC has been designed so that it can run the same programs as many of today's microcomputers. For example, it can run the same programs as an IBM PC. You could, for example, take the disk you use to run your word processing program on an IBM PC and use it directly in your AMSTRAD PC.

The AMSTRAD PC is supplied to you with:

- Microsoft's MS-DOS Version 3.2
- Digital Research's GEM Version 2.0
- Locomotive Software's BASIC 2

MS-DOS's role is to supervise the work your AMSTRAD PC carries out. It also provides tools for keeping your stored information and programs organised.

GEM presents the facilities of your machine and the facilities of your programs graphically - through pictures and menus on the screen. You tell your AMSTRAD PC what you want to do by just pointing to the relevant part of the screen display and clicking a button on the PC's mouse.

An increasing number of programs take advantage of the facilities provided by GEM. But running these programs isn't the only use to which you can put GEM: you can use it to load and run all the other programs you buy for your AMSTRAD PC and you can use it in keeping your work organised. The part of GEM that helps you with all these tasks is called the GEM Desktop - because it is designed to make working with your computer as easy as working at a desk.

Locomotive BASIC 2 is provided for when you want to write your own programs. BASIC 2 is a powerful, GEM-based programming system that helps you:

- to write fully structured programs involving complex data manipulation and filehandling, with the aid of a menu-driven program editor

- to manipulate text and graphics on the screen - lines, arcs, circles, ellipses, pie charts etc. etc.
- to use LOGO-like turtle graphics, for example in educational applications

About this manual

This manual is in five parts.

- **Part I: Fundamental aspects of using the AMSTRAD PC**
- **Part II: Using the GEM Desktop**
- **Part III: Using MS-DOS Commands**
- **Part IV: Introduction to Locomotive BASIC 2**
- **Appendices**

Each Part starts with its own contents list, describing the chapters it contains. The subdivisions within any chapter are called sections.

Part I describes how to connect up the various parts of your AMSTRAD PC and then takes you through your first steps in using your PC. It also tells you about the disks and the programs you should buy for your AMSTRAD PC and how to use these. This part of the manual includes an introduction to computing for anyone using a microcomputer for the first time.

Part II describes how to use the GEM Desktop to carry out tasks on your AMSTRAD PC. It covers both the techniques involved in using GEM software and the actions needed to, for example, transfer a program from one disk to another. Each type of job is described in a separate chapter.

Part III describes how to carry out a broader range of tasks by typing instructions to MS-DOS. You may also need this older style of working to run programs that haven't been set up for running under GEM. Each type of job is described in a separate chapter, with details of the commands involved given at the end of each section.

Part IV provides a brief introduction to the BASIC 2 programming language - taking you on a guided tour of this GEM-based BASIC and summarising its wide range of facilities. (We have also published a comprehensive guide to Locomotive BASIC 2, which includes an introduction to writing programs for those with little or no experience of using the BASIC programming language, while a

Technical Reference on BASIC 2 is available from Locomotive Software.)

Appendices at the end of the manual give pointers to more advanced use of your AMSTRAD PC system.

If you want to use your PC simply to run programs you buy, then all the information you need to get these running is given in Part I of the manual. The programs' own user guides should tell you everything else you need to know.

Whilst you would normally run versions of programs specifically intended for the AMSTRAD PC, it will generally be possible to run programs intended for the IBM PC and for PC compatibles. Again all the information you will need will either be in Part I of this manual or in the programs' own user guides.



CONTENTS

Part I: Fundamentals of using the AMSTRAD PC

- | | | |
|----------|---|------------|
| 1 | Fundamentals of computing | 1 |
| | What is a computer; How your disks are organised; Bringing your filing system up to date | |
| 2 | Setting up the AMSTRAD PC | 7 |
| | Fitting the mains plug; Setting up the System Unit; Connecting the Display to the System Unit; Connecting the joystick to the keyboard | |
| 3 | Preparing for future use | 15 |
| | First steps; Setting the AMSTRAD PC's internal clock; Backing-up your AMSTRAD PC disks; Learning more about the system | |
| 4 | About disks | 53 |
| | Floppy disks; What type of disks?; How to handle disks; Inserting a disk; Releasing a disk; Hard Disk use and operation | |
| 5 | What the AMSTRAD PC can be used for | 65 |
| | Including: Starting to use Locomotive BASIC 2; Using GEM Paint; Running a GEM-based program; Running a standard DOS program; Running 'Turnkey' programs | |
| 6 | Using GEM to organise your disks | 81 |
| | Copying a disk; Preparing a new disk for use; Copying a file; Deleting a file; Renaming a file; Finding out how large a file is; Finding out how much room there is on a disk; Starting to edit a file | |
| 7 | Using MS-DOS to organise your disks | 95 |
| | Copying a disk; Preparing a new disk for use; Copying a file; Deleting a file; Renaming a file; Finding out how large a file is; Finding out how much room there is on a disk; Starting to edit a file | |
| 8 | Fundamentals of using the AMSTRAD PC | 107 |
| | The Startup procedure; Switching off; Resetting the AMSTRAD PC; About filenames; Using wildcards to specify a number of files; About folder and directory names; Specifying a path; Cleaning the AMSTRAD PC | |

Part II: Using the GEM Desktop

- | | | |
|-----------|---|--------------------------|
| 1 | Introducing GEM | 117 |
| 2 | GEM techniques
Manipulating mouse buttons, icons, menus, windows (title bar, scroll bar), Dialog boxes; What to do when you change disks; Leaving GEM Desktop | 121 |
| 3 | Running programs under GEM
including: Installing programs; Configuring programs; Returning to the GEM Desktop | 149 |
| 4 | Organising your work
Organising your files How GEM shows files and folders; Ways of sorting the directory; Finding out what is stored in a folder; Getting brief information about files
Disk housekeeping Creating a new folder; Copying files and folders; Deleting files and folders; Renaming files; When names conflict; Protecting important files | 155
163 |
| 5 | Processing your disks
Copying disks; Preparing new disks for use | 173 |
| 6 | Using the Desktop accessories
The clock: reading the clock, setting the clock, setting the alarm; The calculator | 177 |
| 7 | The Desktop menus
The File menu; The Options menu; The Arrange menu; The Desktop menu | 185 |
| 8 | Personalising GEM
Setting the features you want; Saving the Desktop | 189 |
| 9 | Outputting pictures and documents
Overview of OUTPUT; Displaying one or more files; Setting up an Output List; Setting up an Output Device; Starting output; OUTPUT menu summary; Using the print spooler | 193 |
| 10 | Alternatives to using the mouse | 217 |

Part III: Using MS-DOS Commands

1	Introducing MS-DOS	219
	Starting to use MS-DOS; Using MS-DOS commands; More about – system prompt, command name, command tail; When commands fail	
2	Overview of MS-DOS commands	227
	Tasks to use MS-DOS commands for: Running programs, Organising your work, Tailoring the AMSTRAD PC to your needs; Some practice in using MS-DOS commands	
3	Conventions	235
4	Running programs	239
	4.1 Running a program	
	4.2 Shortcuts at the keyboard	
	4.3 Redirecting input and output	
	4.4 Setting up a sequence of commands	
5	Organising your work	301
	5.1 Putting files into groups	
	5.2 Disk housekeeping	
	5.3 Protecting your files	
6	Processing disks	347
	6.1 Preparing new disks for use (Formatting)	
	6.2 Copying disks	
	6.3 Checking disks	
	6.4 Comparing disks	
7	Tailoring the AMSTRAD PC to your needs	359
	7.1 Setting up Input and Output Devices	
	7.2 Personalising your PC	
	7.3 Setting the AMSTRAD PC's clock	
8	MS-DOS command summary	379

Part IV: Introduction to Locomotive BASIC 2

- 1 An Introduction to BASIC 2** **387**
What BASIC 2 is for; Entering BASIC 2; Using BASIC 2; Leaving BASIC 2
- 2 A Guided Tour of BASIC 2** **393**
Running a program from the Desktop; Drawing circles, boxes, ellipses...; Different ways of outputting text; Preparing a program
- 3 The BASIC 2 Menus and Function keys** **399**
3.1 The File menu
3.2 The Program menu
3.3 The Edit menu
3.4 The Fonts menu
3.5 The Colours menu
3.6 The Patterns menu
3.7 The Lines menu
3.8 The Windows menu
3.9 The BASIC 2 menu
3.10 The Function keys
- 4 BASIC 2 Commands** **405**
4.1 Commands for manipulating data
4.2 Program control
4.3 Input and Output of data
4.4 Screen Graphics
4.5 Turtle Graphics
4.6 Advanced features of BASIC 2

APPENDICES

- Appendix I: Buying and Installing programs** **413**
Suitable programs; Selecting which system software to use; First steps; Making the software convenient to use; Using the mouse
- Appendix II: Setting up the Battery Backed RAM** **421**
The initial default values; To change the default values; Changing the batteries

Appendix III: The AMSTRAD PC character sets	428
To find the key that produces a particular character; To find the internal code for a particular character; The special fonts	
Appendix IV: The AMSTRAD PC hardware	433
The display; The keyboard; Device names	
Appendix V: Expanding your AMSTRAD PC	445
Installing a printer; Communications links; Installing an expansion board; Adding a joystick; Re-configuring system software	
Appendix VI: Reference material on the AMSTRAD PC	459
Guides to the software; Guides to the hardware	
Appendix VII: Troubleshooting	461
Trouble during Startup or when resetting your PC; When commands fail; Trouble with the keyboard; Trouble with a disk drive; Trouble with a printer; Trouble with a mouse; GEM messages; Disk and Device errors; System messages; Hardware error messages	
Appendix VIII: Using GEM Paint	477
Appendix IX: The AMSTRAD PC System Disks	481
The files stored on each disk and when they are used	

INDEX

End User Licence Agreements

100
101
102
103
104
105
106
107
108
109
110
111
112
113
114
115
116
117
118
119
120
121
122
123
124
125
126
127
128
129
130
131
132
133
134
135
136
137
138
139
140
141
142
143
144
145
146
147
148
149
150
151
152
153
154
155
156
157
158
159
160
161
162
163
164
165
166
167
168
169
170
171
172
173
174
175
176
177
178
179
180
181
182
183
184
185
186
187
188
189
190
191
192
193
194
195
196
197
198
199
200

201
202
203
204
205
206
207
208
209
210
211
212
213
214
215
216
217
218
219
220
221
222
223
224
225
226
227
228
229
230
231
232
233
234
235
236
237
238
239
240
241
242
243
244
245
246
247
248
249
250
251
252
253
254
255
256
257
258
259
260
261
262
263
264
265
266
267
268
269
270
271
272
273
274
275
276
277
278
279
280
281
282
283
284
285
286
287
288
289
290
291
292
293
294
295
296
297
298
299
300

301
302
303
304
305
306
307
308
309
310
311
312
313
314
315
316
317
318
319
320
321
322
323
324
325
326
327
328
329
330
331
332
333
334
335
336
337
338
339
340
341
342
343
344
345
346
347
348
349
350
351
352
353
354
355
356
357
358
359
360
361
362
363
364
365
366
367
368
369
370
371
372
373
374
375
376
377
378
379
380
381
382
383
384
385
386
387
388
389
390
391
392
393
394
395
396
397
398
399
400

PART I: USING THE AMSTRAD PC

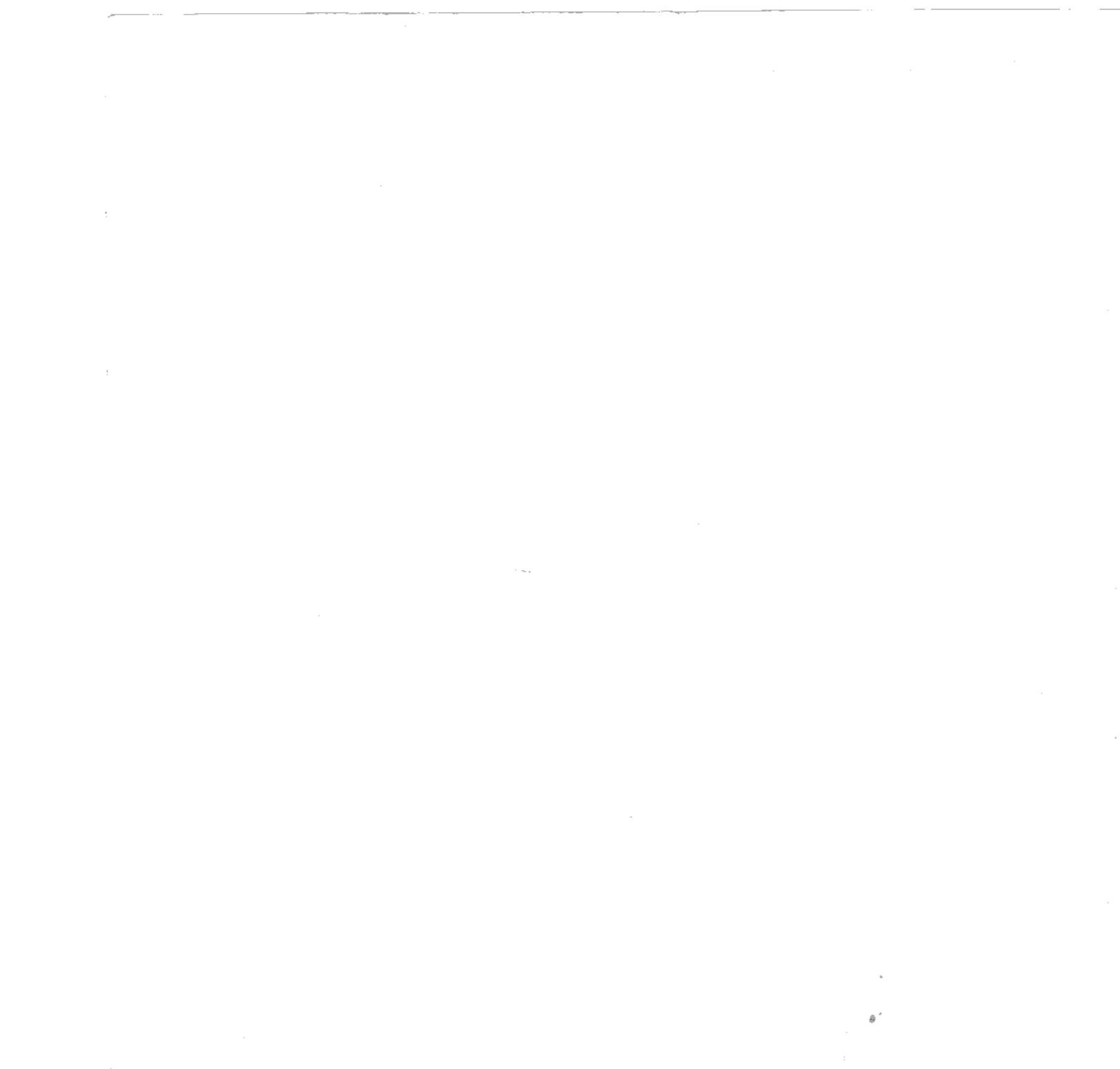

CONTENTS

1. <i>Fundamentals of computing</i>	1
What is a computer	1
How your disks are organised	2
Bringing your filing system up to date	4
2. <i>Setting up the AMSTRAD PC</i>	7
Fitting the mains plug	8
Setting up the System Unit	9
Connecting the Display to the System Unit	10
Connecting the keyboard and the mouse	12
Connecting a joystick to the keyboard	13
Connecting a printer to your PC	14
3. <i>Preparing for future use</i>	15
Single Drive PC	17
Dual Drive PC	21
Hard Drive PC	26
First steps	34

Backing-up your AMSTRAD PC disks 38

Learning more about the system 42

Finding your way about

Running the DOODLE program

Seeing more of the doodle

Changing where the doodle is

Moving the doodle in the window

A more sophisticated doodle

Leaving DOODLE

Switching off 52

4. About disks 53

4.1 Floppy Disks 53

4.1.1 What type of disks 53

Important features of disks

4.1.2 How to handle disks 55

4.1.3 Inserting a disk into a floppy disk drive 56

4.1.4 Releasing a disk from a floppy disk drive 57

4.2 Hard Disks 57

4.2.1 General operation of the Hard Disk PC 57

4.2.2 Command Reference 59

4.2.3 Hard Disk Operating Systems 62

4.2.4 Transporting the Hard Disk PC 63

5. What you can use your AMSTRAD PC for	65
5.1 Starting to use Locomotive BASIC 2	67
5.2 Starting to use GEM Paint	70
Creating a special GEM Paint disk	
Starting a new picture	
Changing an existing picture	
5.3 Running a GEM-based program	73
5.4 Running a popular DOS program	74
From the GEM Desktop	
Using a MS-DOS command line	
5.5 Using a 'Turnkey' program	78
Switch on and run	
Running the program when your PC is already on	
6. Using GEM to organise your disks	81
6.1 Copying a disk	82
6.2 Preparing a new disk for use	84
6.3 Copying a file	85
6.4 Deleting a file	88
6.5 Renaming a file	90
6.6 Finding out how large a file is	91
6.7 Finding out how much unused storage space there is on a disk	91
6.8 Using the Editor to create or change a text file	92

1. FUNDAMENTALS OF COMPUTING

This chapter is designed to introduce newcomers to the sort of tasks that can be carried out on a computer and to some of the jargon that you may read or hear. If you are keen to start using your AMSTRAD PC, don't bother to read this chapter now - go on to Chapter 2. Come back to this chapter later if you have never used a microcomputer or if you haven't used a DOS operating system before.

What is a computer?

A computer is a complex system of electronics that is used to store, manipulate and retrieve data for you. This data can take a variety of forms. For example, it can be:

- **numbers** (if you are using the computer as a highly sophisticated calculator)
- **text** (if you are using the computer as a 'word processor')
- **a mixture of the numbers and text**

The data is manipulated through sequences of instructions known as programs. Each program carries out a specific task or series of tasks. It might, for example, maintain your telephone list or it might process your accounts for you. Programs that do such tasks are often described as Applications.

The electronics is called the computer's hardware; the programs are called its software.

To run your programs, your computer needs some special software known as the Operating System. This has the job of interpreting your instructions and getting the computer to carry out tasks for you. The operating system is often described as 'breathing life into the computer' - to remind you that it has to be loaded into the computer before any program can be run. The AMSTRAD PC's operating system is called MS-DOS often abbreviated to DOS.

To tell your AMSTRAD PC what programs you want run or tasks carried out, you need a means of 'talking' to the operating system. It also needs to 'talk back' to you to tell you the result of its operations, report errors and tell you that it is ready for another instruction.

To achieve this, the computer has:

- a **keyboard** through which you can type in information and instructions
- a **Display screen** through which the operating system can send you messages and display results

The information and instructions supplied to a computer are called Input and the messages and information produced by the computer are called Output. Because you use the keyboard to supply information, the keyboard is described as an Input Device. Similarly, the Display screen is described as an Output Device because it is used to display information produced by the computer.

The keyboard isn't the only way instructions can be provided to your PC. The AMSTRAD PC has a little hand-held unit called a Mouse which you can use with

some programs to point to items displayed on the screen. So the mouse is an Input Device too.

The AMSTRAD PC also has connectors for a printer (an Output Device) and for a communications link (both an Input and an Output Device). You may hear Input and Output Devices being called Peripherals, just as you may hear the connectors being called Ports.

So that the operating system can interpret your instructions, there needs to be a set of rules about how your instructions should be given and standard ways in which your computer replies to you. These go together to form what is called the Interface. The AMSTRAD PC offers you a choice of ways of working through its two interfaces:

- **the GEM Graphics Interface**, which uses pictures to represent the options available to you
- **the DOS Command Interface**, which responds to commands typed in at the keyboard

While a program is running, both the data being processed and the necessary instructions are held in the computer's memory (which is known as its RAM). Some special programs, known as the operating system's Internal Commands, are held in the memory all the time you are running programs. All other programs have to be read into the computer's memory each time they are used and are erased from memory the moment the program has finished.

There is only a limited amount of storage space in a computer's RAM and any information held in RAM is lost the moment the computer is switched off.

A permanent way of storing programs and data for your AMSTRAD PC is provided by floppy and hard disks. (You may also see these referred to as Diskettes or Discs.) You make the information on the disks available to your computer by inserting the disks in the disk drives and telling your PC to read the information into its memory. You can also instruct the computer to record information stored in its memory on a disk - by 'writing the data to the disk'.

Each of these processes involves making a copy of the information: writing to the disk makes a copy of the information in the computer's memory on the disk and reading from a disk makes a copy in the computer's memory of the information stored on the disk. Information written on a disk stays on the disk until it is either overwritten or deliberately erased.

How your disks are organised

Programs and data are kept in files, both in the computer's memory and on disks. Each file typically contains either a program or a quantity of related data, and each file has a name to identify it by.

The way computer files are organised when they are stored on a disk is most easily understood by comparing your disks with a filing cabinet.

Each computer file is like an individual letter or a document in the filing cabinet. Indeed, the GEM software often calls a file that contains data a document. Each disk is like a drawer of the filing cabinet and putting a disk into a drive is like opening one drawer of the filing cabinet. The number of disk drives you have can be thought of as the number of drawers in the filing cabinet that you can have open at the same time.

Just as you keep the letters and documents in a filing cabinet in folders, so you keep computer files on a disk in folders. The folder on the computer disk also contains a list of the items that have been put in that folder. This list is called a directory and, for this reason, the folders are often called Directories.

You could keep everything in one folder both in the filing cabinet and on your computer disk but then you would have so many different items in the folder that it would become increasingly difficult to find the file or letter you want. To make the files more manageable, you group them into different folders.

The first thing you see when you pull open a drawer or put the disk in the drive is a set of folders. The only clue you have to their contents is the name the folder has.

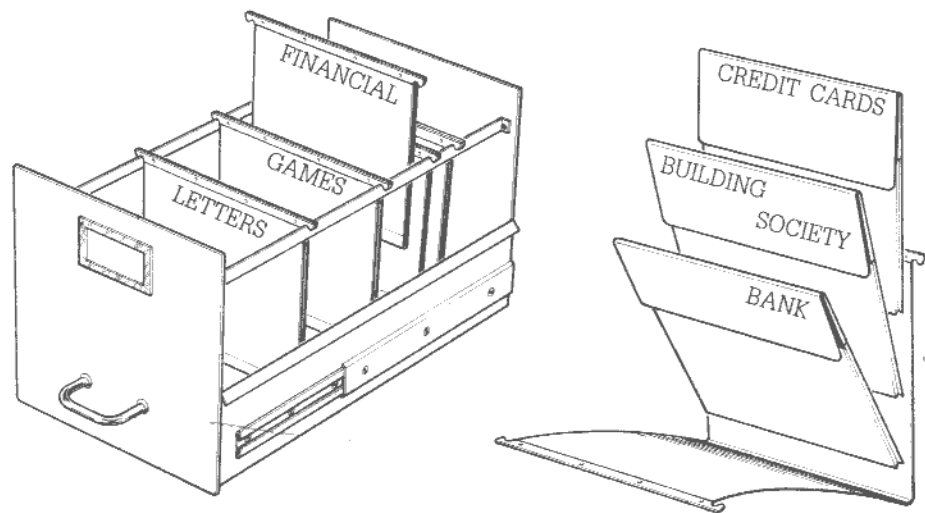

If you select a particular folder from your filing cabinet and open it, you will see either a number of documents or further folders (or a mixture of the two). Similarly, if you open a folder on your computer disk, you will see either a number of files or further folders. The further folders divide up the contents of the main folder once again into more manageable groups.

To see what was in one of the new set of folders, you would once again select the folder and open it - whether you were handling the contents of the filing cabinet drawer or the contents of your disk.

The standard way of representing this pattern of folders is by a sort of family tree, starting at the top with the tree's Root and then branching out into the folders used to group the files on the disk. The folders in our filing cabinet would be represented as:

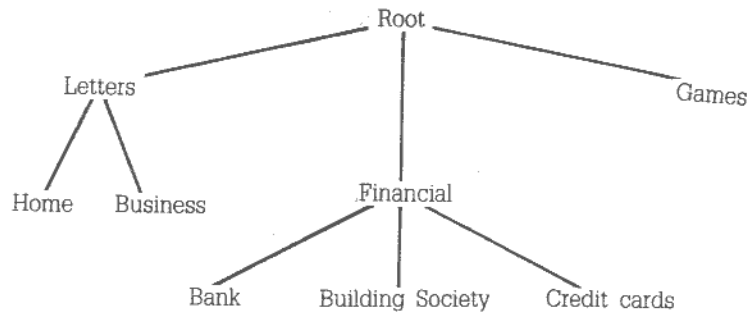

On a computer disk there would be a directory for each folder, just holding details of items on the next level down the tree. For example:

- the Root directory will just have the entries 'Letters', 'Financial' and 'Games'
- the 'Financial' directory will just have the entries 'Bank', 'Building Society' and 'Credit cards' (plus the names of any files sitting alongside these three folders in the Financial folder)

If you think about it, the Root directory always summarises the entire contents of the disk.

Before we leave this section, a couple of definitions. Just as you generally select one folder from your filing cabinet to use at a time, so you select one main directory to work with at any one time. This directory is known as the Default Directory (because it is the directory your PC assumes you want to work with unless you tell it otherwise). Similarly, you select one disk drive as the principal drive you are working with: this drive is known as the Default Drive.

Bringing your filing system up to date

Sorting out the files you have stored on disk is like sorting out a filing cabinet - something you do to ensure that you are keeping the information you want in the places you want and not wasting space by storing information you no longer need. The processes involved are often called Disk Housekeeping.

The operations you can carry out are:

- creating new folders
- deleting folders you no longer want
- creating new files
- editing existing files to bring them up to date
- deleting files you no longer want
- copying files
- renaming files

Creating a new folder is like putting a new folder into your filing cabinet drawer, ready to hold either new documents or documents you move to the new folder.

Deleting a folder is equivalent to throwing away an existing folder, contents and all.

Creating a file is just like producing a new letter or document and then storing it in the appropriate folder in the filing cabinet. Your accounting program, for example, may generate invoices which you would store in separate files in a single folder on your disk - just as you would store individual invoices you drew up by hand.

Editing a file produces an up to date version of a document and replaces the old document with this new version. Files are edited by running a special program called a text editor and using this to change your file.

Copying a file or a document is equivalent to taking a photocopy of an existing letter and storing this in a folder in another part of your filing system. Neither the original letter nor the original file is in any way changed by the copying process, and in both cases, you can either keep the same name for the copy or give it a new one. However, if you decide to keep the copy in the same folder as the original, you will need to give the copy a different name.

Renaming a file is equivalent to giving a letter a new reference number but leaving it in the same folder. However, files are often all you can rename: you typically can't rename a folder on a disk in the same way that you can relabel a folder in the filing cabinet.

Deleting a file is equivalent to taking a letter out of the filing cabinet and throwing it into the fire. The information that was stored in the file cannot be recovered.

2. SETTING UP YOUR AMSTRAD PC

This chapter describes how to set up your AMSTRAD PC. However experienced you are in using microcomputers, you are advised to follow ALL the instructions given both in this chapter and in Chapter 3, which describes how to prepare for your future use of the AMSTRAD PC. If you rush on too quickly to running programs, you risk corrupting the software supplied with your AMSTRAD PC: the consequence of this will be that you have to buy new copies of this software from your dealer.

To set up and use your AMSTRAD PC, you will need a clear, dust-free area on a desk or table that is about 4ft wide and 3ft deep.

The boxes in which your AMSTRAD PC is supplied should contain the following:

- Box 1** – an AMSTRAD PC System Unit, with built-in disk drive(s) in the front panel
- a Keyboard
 - a Mouse
 - four AA size Batteries (slotted into the System Unit packaging)
 - a Manual
 - four 5¼ inch Floppy Disks

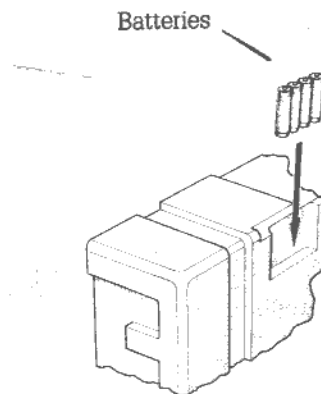

- Box 2** – an AMSTRAD PC Display (Enhanced Colour, Colour or Monochrome)

Before you read any further, unpack both boxes and check that you have all these items. If any item is missing, consult your dealer. Save all the packing materials in case you want to transport your PC elsewhere at some later date.

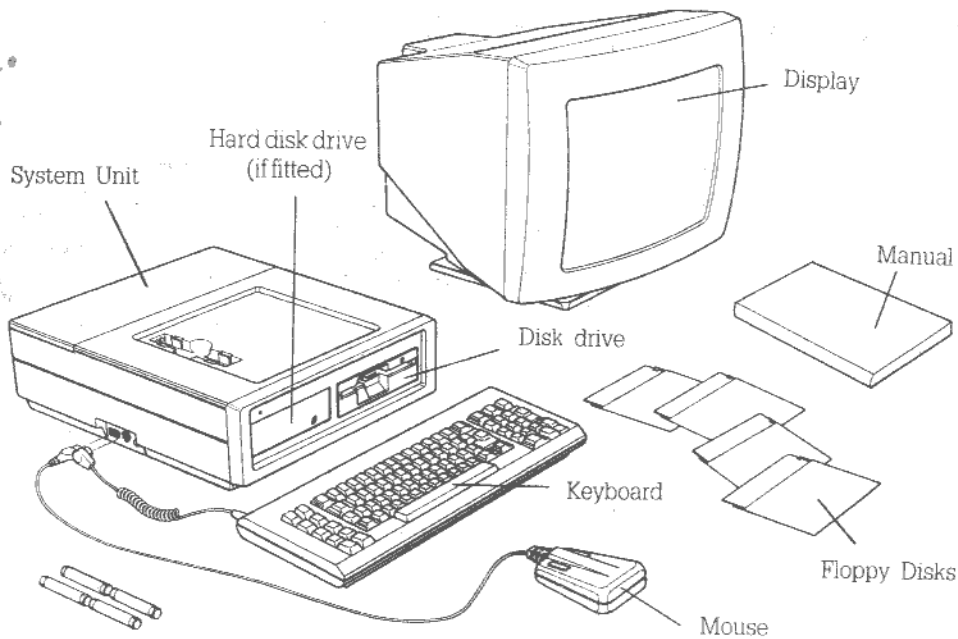

If you have a floppy disk PC you will also need at least four new blank floppy disks. Ask your dealer for 5¼ inch double-sided double-density soft-sectored 48tpi disks. (These are the same disks as those used in an IBM PC.) Buy disks that are labelled to show who produced them. Don't buy cheap unlabelled disks. If you read the cartoon sheet that comes with this manual, you will find this contains useful information about buying and using disks for your AMSTRAD PC.

Fitting the mains plug

The AMSTRAD PC operates from a 220–240Volt 50Hz AC mains supply.

Fit a proper mains plug to the mains lead on the Display. If a 13Amp (BS1363) plug is used, a 5Amp fuse must be fitted. The 13Amp fuse supplied in a new plug must not be used. If any other type of plug is used, a 5Amp fuse must be fitted either in the plug or in the adaptor or at the distribution board.

WARNING – THIS APPARATUS MUST BE EARTHED

IMPORTANT: The wires in the mains lead are coloured in accordance with the following code:

Green and Yellow	: Earth
Blue	: Neutral
Brown	: Live

As the colours of the wires in the mains lead of this apparatus may not correspond with the coloured markings identifying the terminals in your plug, proceed as follows:

The wire which is coloured green-and-yellow must be connected to the terminal in the plug which is marked with the letter 'E' or by the safety earth symbol \perp or coloured green or green-and-yellow.

The wire which is coloured Blue must be connected to the terminal which is marked with the letter 'N' or coloured black.

The wire which is coloured Brown must be connected to the terminal which is marked with the letter 'L' or coloured red.

IMPORTANT: DO NOT PLUG YOUR AMSTRAD PC INTO THE MAINS SUPPLY YET

Disconnect the mains plug from the supply socket when not in use.

Do not attempt to remove any screws or to open the casing of either the Display or the System Unit. Always obey the warning on the rating label on the back of the Display.

WARNING - LIVE PARTS INSIDE. DO NOT REMOVE ANY SCREWS.

Setting up the System Unit

Place the System Unit on your table with the disk drive(s) to the front. For each disk drive in turn:

Turn the drive door handle anticlockwise from a vertical position to a horizontal one.

This opens the drive.

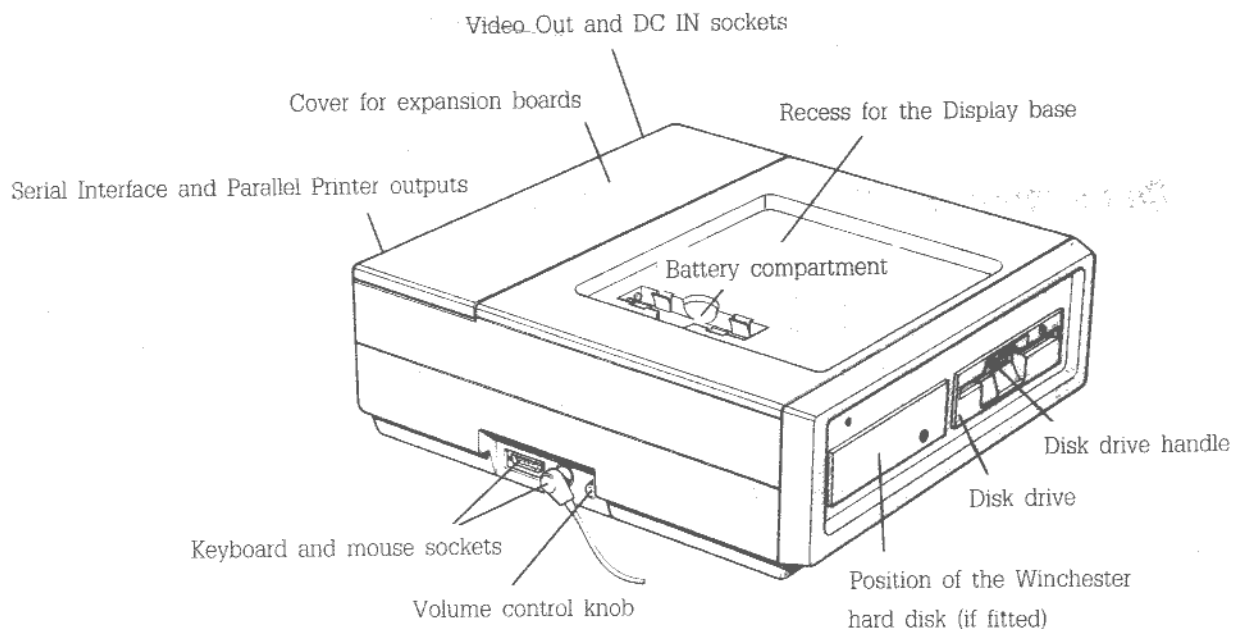

Inserting the batteries

- 1 Slot the four AA batteries into the battery compartment on the top of the System Unit as shown below.**

Check that you put each battery the right way round, with its positive (+) end over the plus sign inside the battery housing.

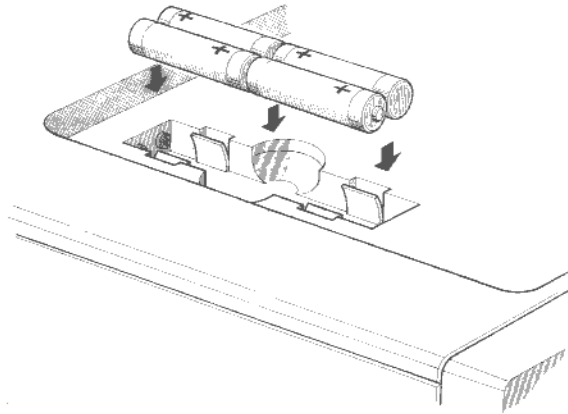

The batteries are used to power a special area of your PC's memory which is used for storing information that needs to be carried over from one time you use your PC to another – for example, the setting of the date and time clock or the details of the communications links you have attached to your PC. This section of the memory, called the Battery-Backed RAM, is constantly powered from batteries to ensure this information isn't lost.

These batteries will need changing about once a year, and we recommend that you replace the batteries with new ones on a regular basis before the old batteries have gone flat. How to go about changing the batteries is described in Appendix II.

Connecting the Display to the System Unit

- 1 Check that the Display is not plugged into the mains supply.**
- 2 Place the Display on top of the System Unit. The base of the Display fits into the recess in the top of the System Unit.**
- 3 Insert the 9-pin plug on the end of the VDU Cable leading from the back of the Display into the socket marked 'Video Out' on the back panel of the System Unit. (Illustrated below.)**
- 4 Insert the 14-pin plug on the end of the DC Cable leading from the back of the Display into the socket marked 'DC IN' on the back panel of the System Unit. (Illustrated below.)**

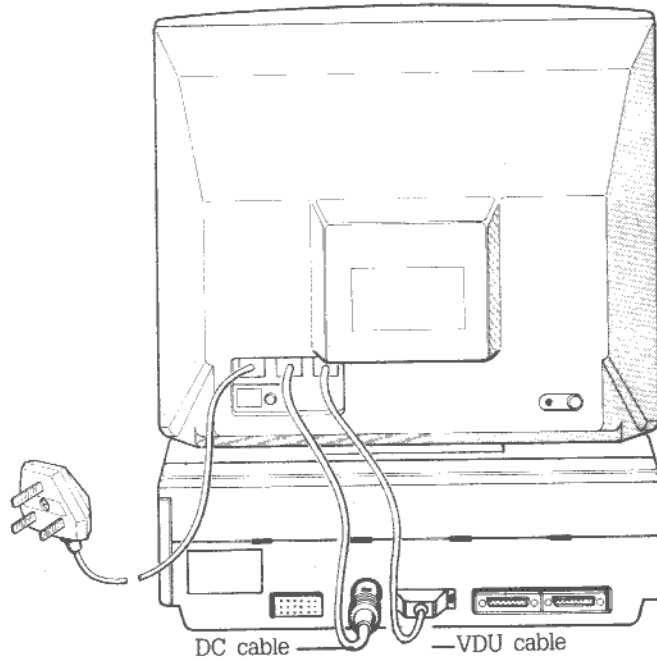

5 Arrange the System Unit and keyboard on your table, ready for use. Swivel the Display so that its screen is at a suitable angle. (You can always adjust it again later.)

IMPORTANT: If you look at the screen of the Display you will notice a red transparent label. Read the label and follow the instructions given, depending on the type of Display you have got with your PC i.e. Enhanced Colour (ECD), Colour (CD), or Monochrome (MD).

Monochrome:

If you have a Black and White (Monochrome), Display all you have to do is check that the Display Selector Switches on the back of the System Unit have been set as shown below. These switches are factory set before shipping so you should not have to make any adjustment.

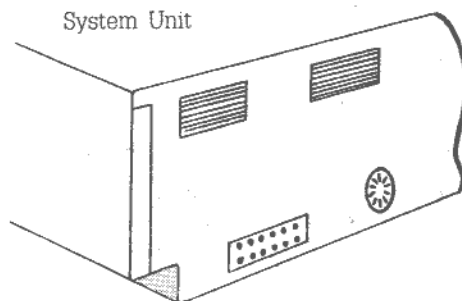

Monochrome Display

Display Selector Switches



Colour:

Configure the Display Selector Switches on the back of the System Unit as shown in the diagram below if you have a Colour Display with your PC.

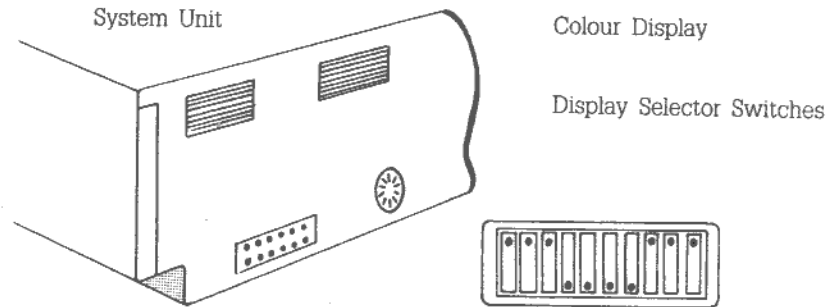
**Enhanced Colour:**

If you have an Enhanced Colour Display then configure the Display Selector Switches on the rear of the System Unit as shown.

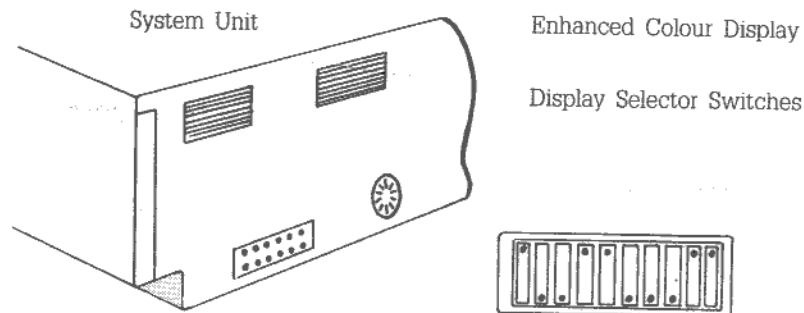

An Enhanced Colour Display can be operated as if it was a Colour Display if required, how to do this is explained in Appendix IV. (You may wish to do this in order to use certain software packages.)

Connecting the keyboard and the mouse to the System Unit

- 1 Check that your PC is not plugged into the mains supply.
- 2 Connect the keyboard to the System Unit by inserting the right-angled plug at the end of the keyboard cable into the socket marked 'Keyboard' on the left hand panel of the System Unit.

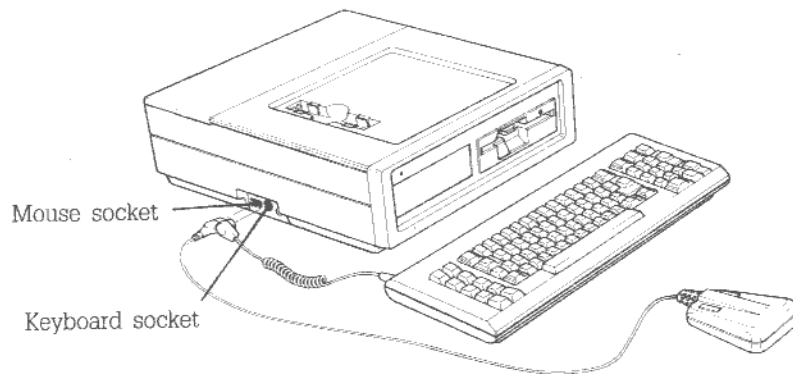

- 3 Connect the mouse to the System Unit by inserting the 9-way 'D-type' plug on the end of the mouse lead into the socket marked 'Mouse' on the lefthand panel of the System Unit.

Connecting a joystick to the keyboard

Some of the software you buy may use a joystick or you may want to use a joystick instead of the cursor keys. You can use any Industry Standard joystick with your AMSTRAD PC.

When you want to use your joystick, connect it by inserting the 9-way 'D-type' plug on the end of the joystick cable into the socket on the back of the keyboard.

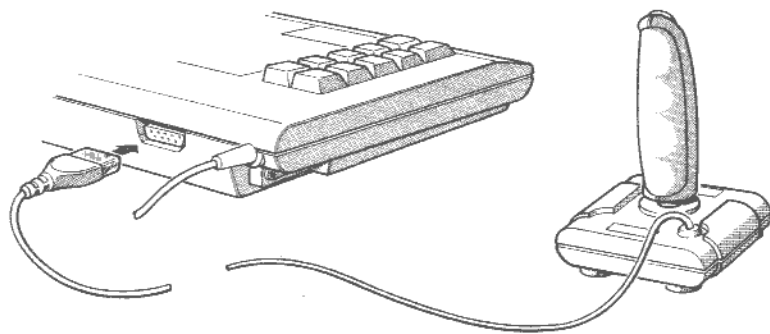

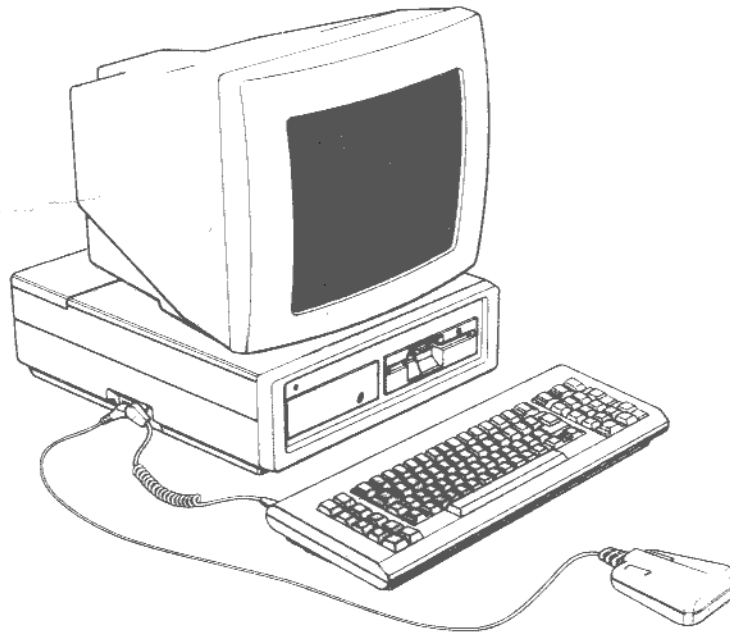

Connecting a printer to your PC

If you have a printer, you may well want to connect this to your AMSTRAD PC.

The first requirement is for a suitable cable to connect your printer to your PC. If you have a Serial printer, you will need a cable that connects your printer to the Serial Interface connector on the back of the System Unit. If you have a Parallel (or Centronics) printer, you will need a cable that connects your printer to the Parallel Printer connector on the back of the System Unit. Your dealer will be able to tell you what type of cable you need.

If your printer is a parallel graphics printer that is compatible with the IBM Personal Graphics Printer (for example, the AMSTRAD DMP3000), you can use the printer straight away. Your AMSTRAD PC has been set up ready for this kind of printer.

If your printer is of some other type, you will need to set up your PC specifically for your printer. How to do this is described in Appendix V, but don't try to do this until you have:

- **finished preparing your PC as described in Chapter 3**
- **learnt the basics of using the DOS operating system as described in Part III**

If you are a newcomer to computing and want to use the printer as soon as possible, we would advise you to seek the help of someone with a lot of experience in using the MS-DOS Operating System.

3. PREPARING FOR FUTURE USE

This chapter tells you how to prepare for future use of your AMSTRAD PC. However experienced you are in using microcomputers, you are advised to follow ALL the instructions given here: there are NO shortcuts. If you rush on too quickly to running programs, you risk corrupting the software supplied with your AMSTRAD PC: the consequence of this will be that you have to buy new copies of this software from your dealer.

Note: (i) If, in following these instructions, things happen that aren't explained here or you see messages that are nothing like the ones described here, turn to Appendix VII: "Troubleshooting" and see if you can find out what has gone wrong. If you can't, consult your dealer.

(ii) The instructions given here use the mouse. If you aren't able to use the mouse for some reason, you can still do this preparatory work. The keys to press instead of using the mouse are given in Chapter 10 of Part II of this manual.

Start with

- the mains plug out of the supply socket
- the power switch on the back of the Display in its OFF position (fully released)
- no disk in any floppy disk drive.

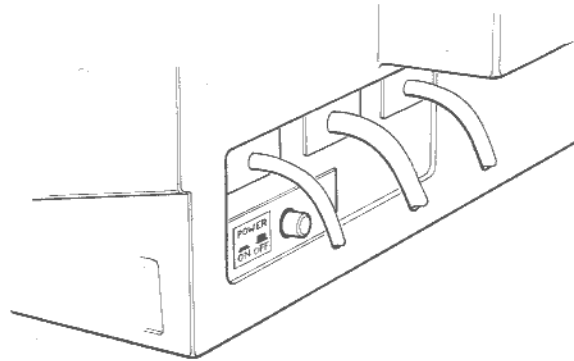

Plug the Display into the mains supply.

Turn the machine on by pressing the power switch. The message **Please wait...** should appear on the screen.

Your AMSTRAD PC then goes through a built-in system check. If all is well, your PC will beep and a message similar to the following will shortly appear on the screen.

AMSTRAD PC 640K (v3)

(c)1987 AMSTRAD plc

Please set date and time

Please set User Options (If required)

If you do not hear a bleep or you feel the bleep is too loud, adjust the Volume Control. This is situated on the lefthand side of the System Unit, next to where the keyboard and the mouse are plugged in. Setting the Volume Control approximately in the middle of its range should suit most people.

If you have not connected the keyboard properly, or something is holding down keys on the keyboard, the following message will appear:

Check keyboard and mouse

Clear away anything resting on the keyboard and check that the keyboard is properly connected to the System Unit. Check that the connector on the end of the keyboard cable is firmly plugged into the socket on the side of the System Unit. Similarly, check that the mouse is properly connected and that the mouse buttons aren't held down by anything. The message should disappear if you clear the problem.

Adjust the brightness and contrast of the messages on the screen to a comfortable level with the aid of the Brightness control and the Contrast control on the righthand panel of the Display. If necessary, also adjust the V-Hold knob on the back of the Display until the display is steady.

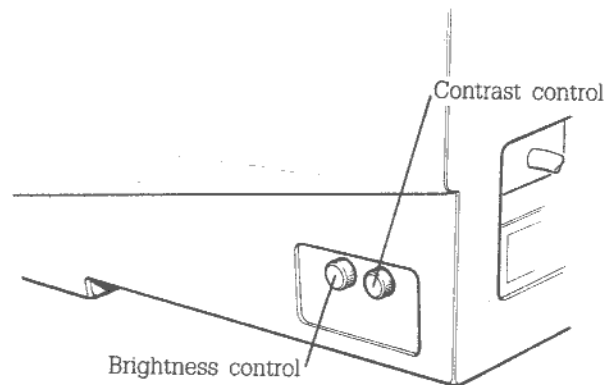

Note: There are three different configurations of the AMSTRAD PC available i.e. Single Disk Drive, Dual Disk Drive and the Hard Disk version. As the Startup procedure varies slightly for each one, for clarity they are described separately below.

The following Disks are the System and Program Disks that you get with your PC (For all Disk Drive configurations):

DISK 1 - MSDOS

DISK 2 - GEM STARTUP

DISK 3 - GEM DESKTOP and BASIC2

DISK 4 - GEM PAINT and OUTPUT

Some of these Disks will be used during the startup procedure.

All you have to do next is read the Startup procedure that is relevant to the PC that you have.

Single Disk Drive PC (SD): go to page **17**
Dual Disk Drive PC (DD): go to page **21**
Hard Disk Drive PC (HD): go to page **26**

Single Disk Drive PC

Having connected-up and switched on your PC as described at the beginning of this Chapter (Chapter 3), you should now have the following message displayed on the screen:

**Insert a SYSTEM disk into drive A
Then press any key**

Select Disk 1 from your set of AMSTRAD PC disks and withdraw it from its paper cover.

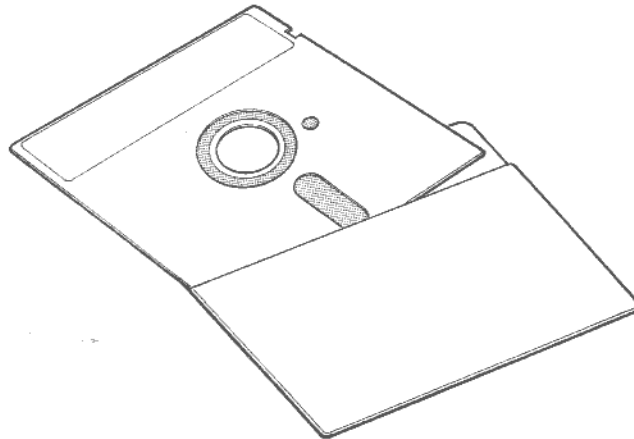

Hold the disk by its labelled end with the label uppermost.
Gently insert the disk into the slot in your disk drive.

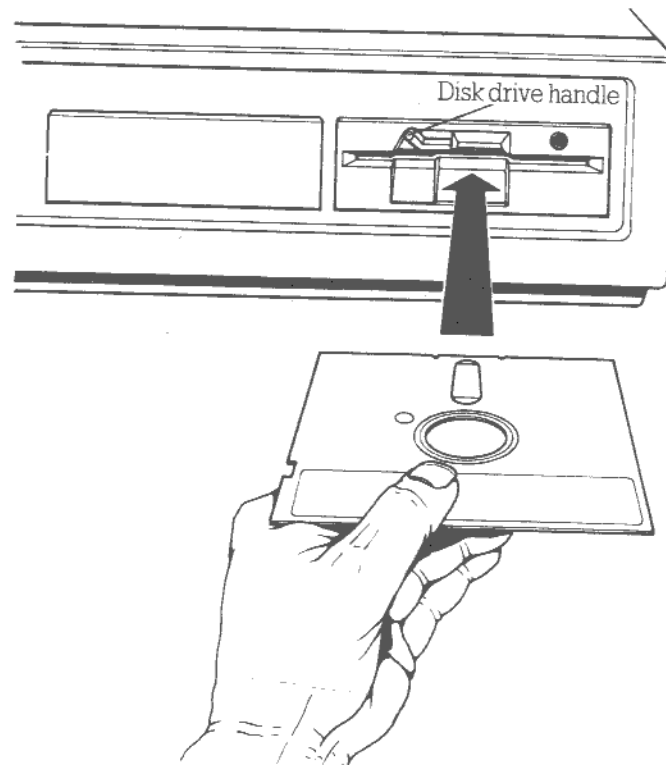

Push the disk all the way into the slot and then turn the drive handle clockwise (from horizontal to vertical). Turning the drive handle across the mouth of the drive slot holds the disk in the drive - closing the drive.

To remove the disk from the drive, turn the drive handle anti-clockwise: this opens the drive, releasing the disk. You can now remove the disk from the drive slot.

Practise inserting and releasing the disk a few times until you feel confident about doing this. Finish with the disk inserted into the slot and the drive handle turned down across the mouth of the drive slot.

Press either the Space Bar or the Carriage Return key () on the keyboard.

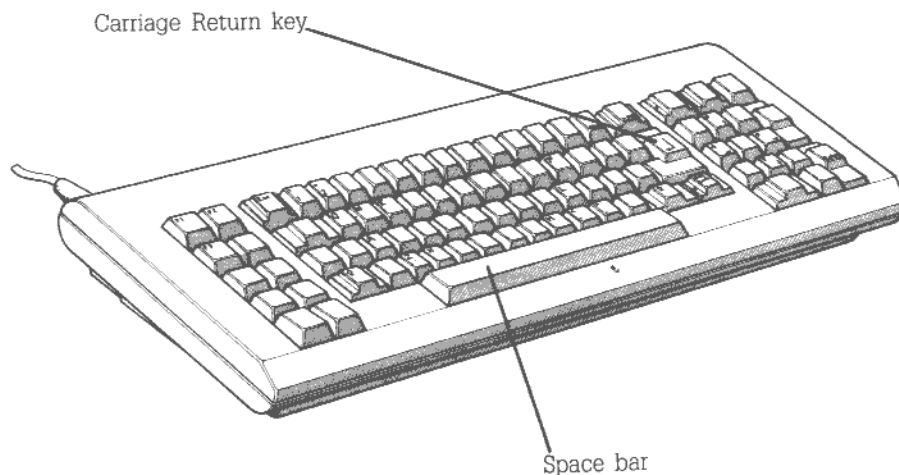

The AMSTRAD PC then reads from this disk. You will see the green indicator light on the drive go on and off a few times while this is happening. If you see a message similar to one of the following:

Non-System disk or disk error
Replace and strike any key when ready

or Not a boot disk
Replace and hit any key

or Wrong disk
Insert a system disk and press any key

open the drive by turning the drive handle and then withdraw the disk from the drive. Check that it is your AMSTRAD PC Disk 1. If you had inserted the right disk, put it back in, turn the door handle across the drive slot and press the Space bar. If it fails again, consult your dealer. If you had inserted the wrong disk, replace this disk in its paper cover and take the right disk out of its cover. Put this disk in the drive and turn the drive handle down. Then press the Space bar.

After a short while a message similar to the following will be displayed:

```
A>ECHO OFF
  ---Installing MOUSE Device Driver V5.00---
A>
```

This is the MS-DOS Command line. If you want to you can start using the MSDOS operating system right away. To do this turn to Part 3 of this guide: "Using MS-DOS commands". But before doing so it is a good idea to set the time of your PC's clock. This is a 24 hour clock maintained in battery-backed RAM (memory). You can do this by using the MS-DOS TIME command as follows:

Type TIME and press the Carriage Return key . The current setting is displayed and then you are asked to type in a new one. If the time displayed is correct just press . If not enter the new time as: hh:mm

where hh represents the hour(00...23) and mm the minute (00...59).

For example to set the time to 4.00pm (16.00 hours) type:

TIME

16:00

Set the date in the same way by using the DATE command.

Type DATE and press the Carriage Return key . The current setting is displayed and then you are asked to type in a new one. If the date displayed is correct just press return. If not enter the new date as: dd-mm-yy

where dd represents the day (01...31), mm the month (01...12) and yy the last two digits of the year (00...99).

For example to set the date to the 26th of December 1987, type:

DATE

26-12-87 and press

Note that the TIME and DATE commands are explained in much greater detail in Part 3.

Loading GEM

To load the GEM Desktop type GEM and press the Carriage Return key .

Your PC may reset itself and re-load Disk 1. Don't worry, this is part of the automatic process by which the PC is set up to run the GEM software. Just wait for the MS-DOS command line: **A>** to be displayed, type GEM (again) and press .

A message will appear on the screen asking you to insert the GEM STARTUP disk (Disk 2) in drive A and press any key when ready. Remove Disk 1 from the disk drive and replace it in its paper cover. Take Disk 2 and insert it in the drive and press a key. The screen will clear and shortly afterwards display the following message:

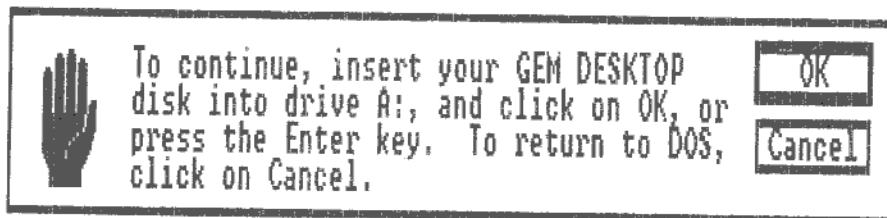

Remove Disk 2 from the Disk drive and replace it with Disk 3. As requested on the screen either move the pointer to the box marked **OK** (using the mouse) and click on it, or press the key.

After a short while you will see a display like this on the screen:

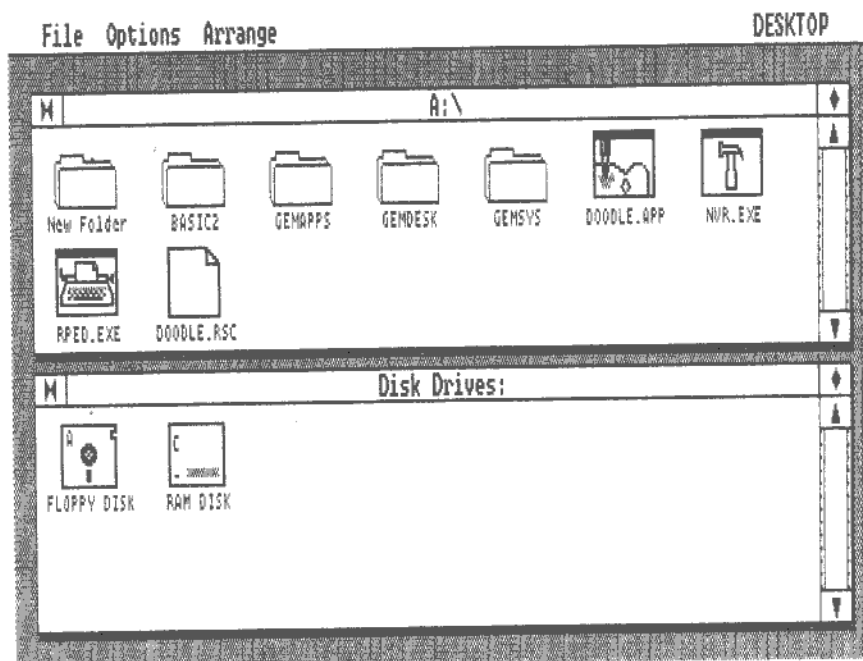

This is the GEM Desktop. Your AMSTRAD PC is now ready for you to start giving it instructions. Refer to the section entitled: "First Steps" on page 34

Dual Disk Drive PC

Having connected-up and switched on your PC as described at the beginning of this chapter (Chapter 3), you should now have the following message displayed on the screen:

Insert a **SYSTEM** disk into drive **A**
Then press any key

Select Disk 1 from your set of AMSTRAD PC disks and withdraw it from its paper cover.

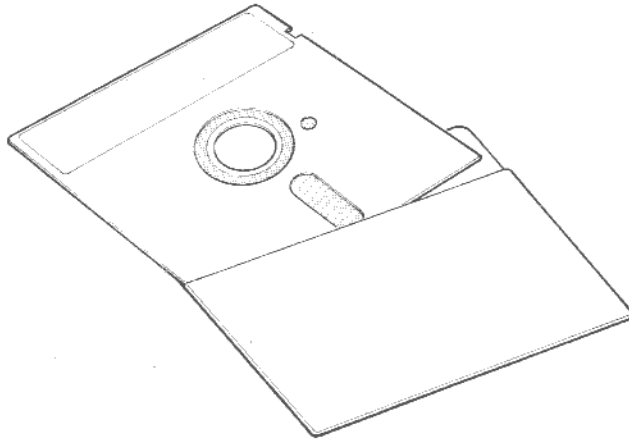

Hold the disk by its labelled end with the label uppermost.
Gently insert the disk into the slot in drive A – the lefthand disk drive.

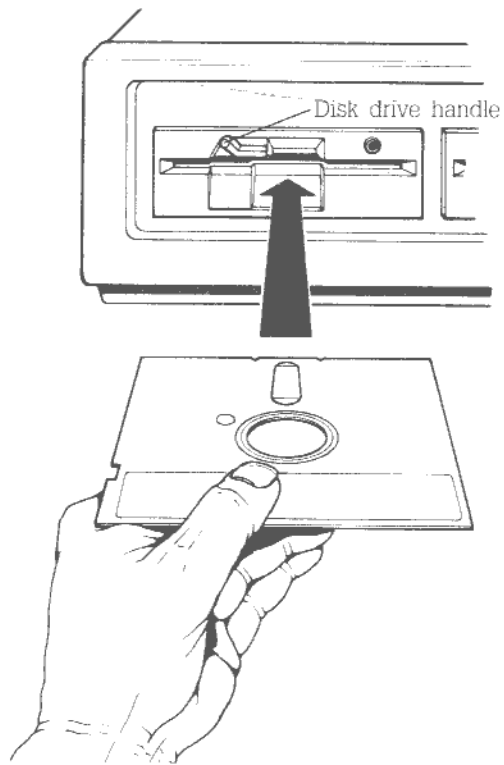

Push the disk all the way into the slot and then turn the drive handle clockwise (from horizontal to vertical). Turning the drive handle across the mouth of the drive slot holds the disk in the drive – closing the drive.

To remove the disk from the drive, turn the drive handle anticlockwise: this opens the drive, releasing the disk. You can now remove the disk from the drive slot.

Practise inserting and releasing the disk a few times until you feel confident about doing this. Finish with the disk inserted into the slot and the drive handle turned down across the mouth of the drive slot.

Press either the Space Bar or the Carriage Return key (↵) on the keyboard.

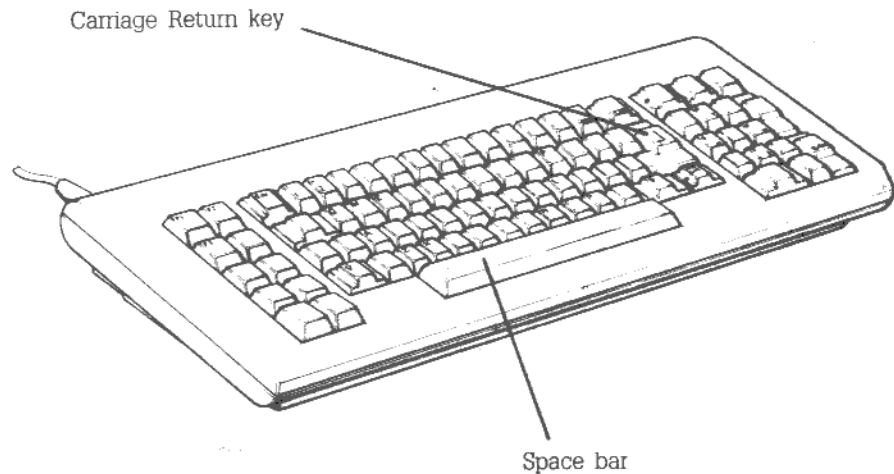

The AMSTRAD PC then reads from this disk. You will see the green indicator light on the drive go on and off a few times while this is happening.

If you see a message similar to one of the following:

Non-System disk or disk error
Replace and strike any key when ready

or Not a boot disk
Replace and hit any key

open the drive by turning the drive handle and then withdraw the disk from the drive. Check that it is your AMSTRAD PC Disk 1. If you had inserted the right disk, put it back in, turn the door handle across the drive slot and press the Space bar. If it fails again, consult your dealer. If you had inserted the wrong disk, replace this disk in its paper cover and take the right disk out of its cover. Put this disk in the drive and turn the drive handle down. Then press the Space bar.

After a short while a message similar to the following will be displayed:

```
A>ECHO OFF
---Installing MOUSE Device Driver V5.00---
A>
```

This is the MS-DOS Command line. If you want you can start using the MS-DOS operating system right away. To do this turn to Part 3 of this guide: "Using MS-DOS commands". But before doing so it is a good idea to set the time of your PC's clock. This is a 24 hour clock maintained in battery-backed RAM (memory). You can do this by using the MS-DOS TIME command as follows:

Type TIME and press the Carriage Return key . The current setting is displayed and then you are asked to type in a new one. If the time displayed is correct just press return. If not enter the new time as: hh:mm

where hh represents the hour(00...23) and mm the minute (00...59).

For example to set the time to 4.00pm (16.00 hours) type:

TIME and press .

16:00 and press .

Set the date in the same way by using the DATE command.

Type DATE and press . The current setting is displayed and then you are asked to type in a new one. If the date displayed is correct just press . If not enter the new date as: dd-mm-yy

where dd represents the day (0...31), mm the month (01...12) and yy the last two digits of the year (00...99).

For example to set the date to the 26th of December 1987, type:

DATE and press .

26-12-87 and press .

Note that the TIME and DATE commands are explained in much greater detail in Part 3.

Loading GEM

To load the GEM Desktop type GEM and press the Carriage Return key .

Your PC may reset itself and re-load Disk 1. Don't worry this is part of the automatic process by which the PC is set up to run the GEM software. Just wait for the MS-DOS command line: A> to be displayed, type GEM (again) and press .

A message will appear on the screen asking you to insert the GEM STARTUP disk (Disk 2) in drive A and press any key when ready. Remove Disk 1 from the drive A and replace it in its paper cover. Take Disk 2 and insert it in drive A and press a key as requested.

Your PC now automatically goes through a short process which customises your GEM Desktop disk (AMSTRAD PC Disk 3) to your two-drive PC.

This customisation is only done once - the first time you use your PC. The program that does the customisation is never used again.

When the following message appears:

**Please insert GEM Desktop disk into Drive B
Press any key when ready...**

take your AMSTRAD PC Disk 3 from its cover, hold it by its labelled end (label uppermost) and insert it into the drive slot of the righthand drive. Turn the drive handle clockwise across the drive slot to hold the disc in the drive and then press the Space bar.

When the customisation has been finished, you will see the message:

GEM Desktop disk now modified for 2 drives

Turn the drive handle on Drive B (the righthand drive) to release the Desktop disk and withdraw the disk completely.

Shortly after that, the screen should clear and show the following message on the screen:

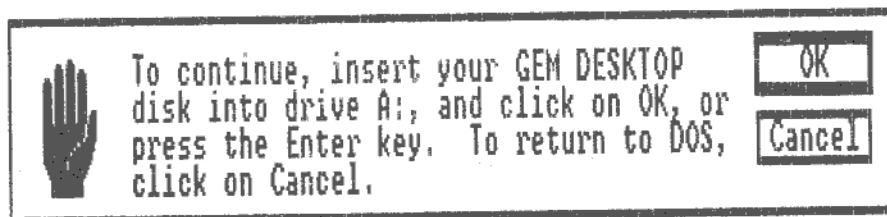

When the green indicator light on the drive is out, turn the drive handle on Drive A: (the lefthand drive) anti-clockwise to release the disk in the drive. Withdraw this disk from the drive and put it back into its paper cover.

Select Disk 3 ('GEM Desktop and BASIC') from the set of disks supplied with your AMSTRAD PC. Remove this from its cover and insert it in drive slot A (the lefthand drive) as before. Turn the drive handle down so that the disk is held in the drive.

Press the  key. After a short while, you will see a display like this on the screen:

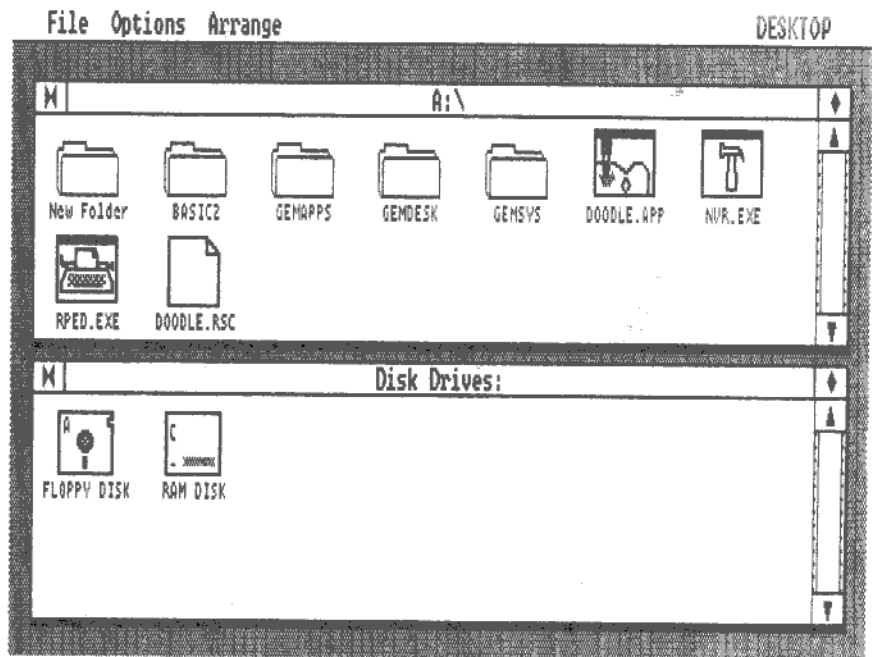

This is the GEM Desktop. Your AMSTRAD PC is now ready for you to start giving it instructions. Refer to the section entitled: "First Steps" on page 34

Hard Disk PC

If after switching-on, the red light on the hard disk flashes and the message shown below appears:

```
C>ECHO OFF
    ---Installing MOUSE Device Driver V5.00---
C>
```

Then your Hard Disk has already been set up and you can go straight to page 34 and proceed from there. Otherwise continue reading below.

Having connected-up and switched on your PC as described at the beginning of this Chapter (Chapter 3), you should now have the following message displayed on your screen:

```
Insert a SYSTEM disk into drive A
Then press any key
```

Select Disk 1 from your set of AMSTRAD PC disks and withdraw it from its paper cover.

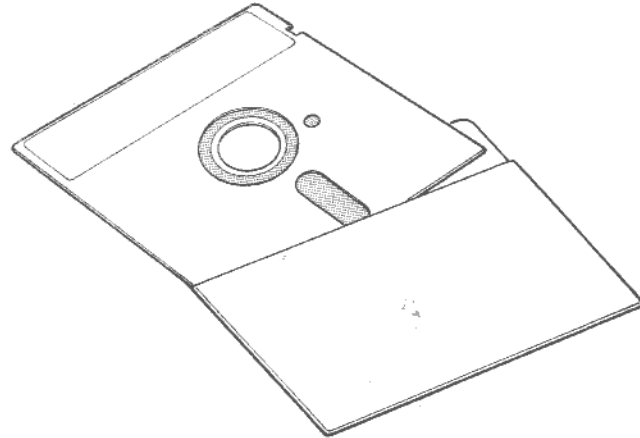

Hold the disk by its labelled end with the label uppermost.
Gently insert the disk into the slot in drive A – the righthand disk drive.

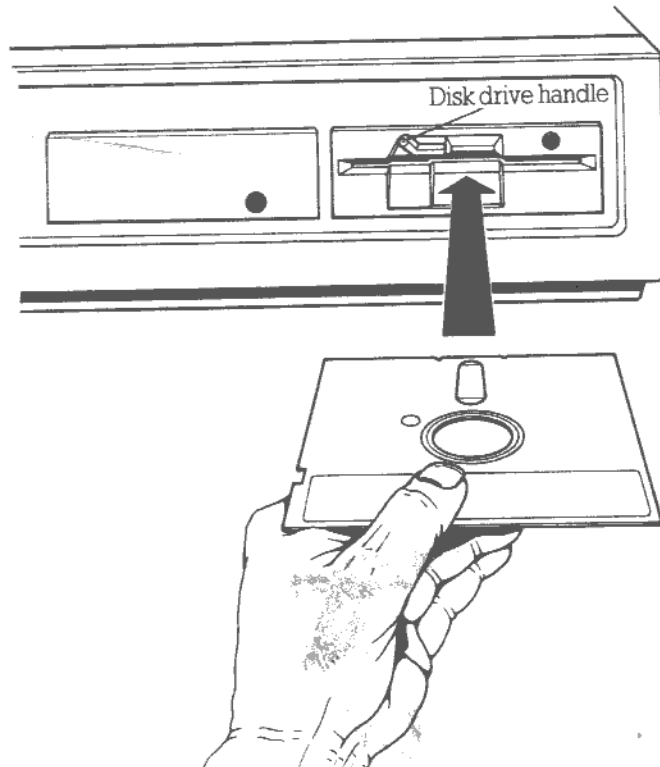

Push the disk all the way into the slot and then turn the drive handle clockwise (from horizontal to vertical). Turning the drive handle across the mouth of the drive slot holds the disk in the drive - closing the drive.

To remove the disk from the drive, turn the drive handle anticlockwise: this opens the drive, releasing the disk. You can now remove the disk from the drive slot.

Practise inserting and releasing the disk a few times until you feel confident about doing this. Finish with the disk inserted into the slot and the drive handle turned down across the mouth of the drive slot.

Press either the Space Bar or the Carriage Return key () on the keyboard.

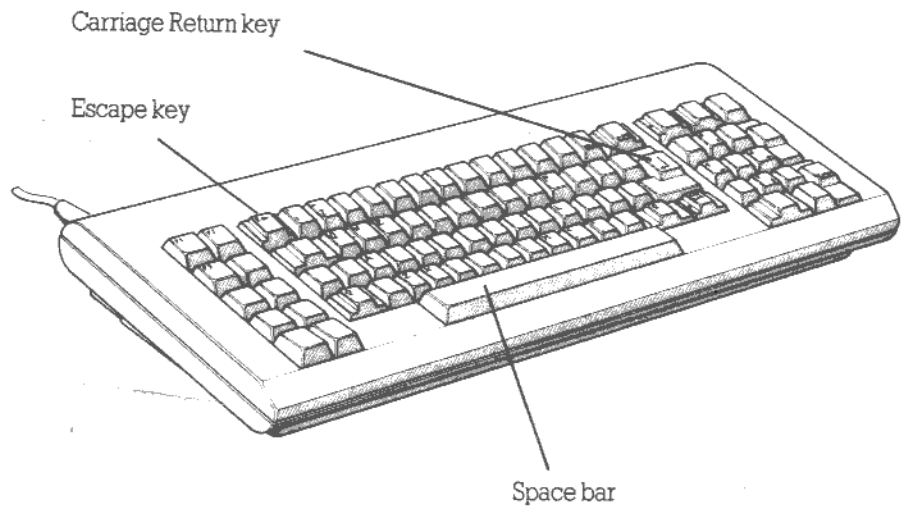

The AMSTRAD PC then reads from this disk. You will see the green indicator light on the drive go on and off a few times while this is happening. If you see a message similar to one of the following:

Non-System disk or disk error
Replace and strike any key when ready

or Not a boot disk
Replace and hit any key

open the drive by turning the drive handle and then withdraw the disk from the drive. Check that it is your AMSTRAD PC Disk 1. If you had inserted the right disk, put it back in, turn the door handle across the drive slot and press the Space bar. If it fails again, consult your dealer. If you had inserted the wrong disk, replace this disk in its paper cover and take the right disk out of its cover. Put this disk in the drive and turn the drive handle down. Then press the Space bar.

After a short while a message similar to the following will be displayed:

```
A>ECHO OFF
--Installing MOUSE Device Driver V5.00--
A>
```

At this stage it is a good idea to set the time of your PC's clock. This is a 24 hour clock maintained in battery-backed RAM (memory). You can do this by using the MS-DOS TIME command as follows:

Type TIME and press the Carriage Return key . The current setting is displayed and then you are asked to type in a new one. If the time displayed is correct just press return. If not enter the new time as: hh:mm

where hh represents the hour(00...23) and mm the minute (00...59).

For example to set the time to 4.00pm (16.00 hours) type:

TIME and press .

16:00 and press .

Set the date in the same way by using the DATE command.

Type DATE and press . The current setting is displayed and then you are asked to type in a new one. If the date displayed is correct just press . If not enter the new date as: dd-mm-yy

where dd represents the day (0...31), mm the month (01...12) and yy the last two digits of the year (00...99).

For example to set the date to the 26th of December 1987, type:

DATE and press .

26-12-87 and press .

Note that the TIME and DATE commands are explained in much greater detail in Part 3.

We must now go through a short process to copy all the information from your four floppy disks onto the hard disk. This only needs to be done once. You should never need to do it again.

At various stages in this procedure, you'll have to type things into the computer using the keyboard. Just press the keys that make up the word; if there are any punctuation or special keys needed they'll be described as and when they're needed. As you type on the keyboard, the computer displays the keys you've pressed on the screen. Don't worry if the letters that appear are in CAPITALS or small characters, it's all the same to the computer. If you press any key by mistake, press and retype the command again, from the beginning. The key is the third key along from the top left hand corner of the keyboard. Another key you'll need to know about is the Carriage Return key. This is towards the right-hand end of the keyboard, and looks like this . (See the previous diagram to locate these keys.)

★ First of all, type in

FDISK (followed by)

After a short while, you should see a message similar to the following:

Fixed Disk Setup Program Version 0.01
(C)Copyright Microsoft, 1985.

FDISK Options

Choose one of the following:

1. Create DOS Partition
2. Change Active Partition
3. Delete DOS Partition
4. Display Partition Data

Enter choice:

Press ESC to return to DOS

Press . The screen should change to:

Create DOS Partition

Do you wish to use the entire fixed
disk for DOS (Y/N)

Press ESC to return to FDISK Options

If the above message appears as expected, then ignore the next few paragraphs and skip to the † on page 31.

If, instead, you see a display similar to:

Create DOS Partition

Partition	Status	Type	Start	End	Size
1	A	DOS	0	610	611

Total disk space is 611 cylinders.

Fixed disk already has a DOS partition.

Press ESC to return to FDISK Options

Then this indicates that the hard disk has already been (at least partially) installed. If the hard disk had been fully installed already, it would have loaded as described earlier. We will therefore assume that the hard disk contains no useful information. In this case press then follow the instructions below, and restart the installation process from the section on page 29 marked with an * asterix.

Open the floppy drive by turning the drive handle and then withdraw the disk from the drive. Carefully replace it in its paper envelope. Now remove Disk 4 - 'GEM Output and supplementary programs' from its envelope, and slide it into the floppy disk drive. Close the door. Now type

SUPPLEME\HDFORMAT (press)

After a moment or two the following message will appear:

DISK FORMAT UTILITY

This routine erases all data

Are you sure you want this ?

(Y)es or (N)o

Type

Y

The hard disk will be completely cleared ready for a brand new installation. The process will take a few minutes, during which time the red light on the front of the hard disk drive will be lit continuously. When it has finished you will see the **A>** prompt.

Open the floppy drive by turning the drive handle and then withdraw the disk from the drive. Carefully replace it in its paper envelope. Now remove Disk 1 - 'Microsoft MS-DOS' from its envelope, and slide it into the floppy disk drive. Close the door.

Now restart the installation process from the section on page 29 marked with an * asterix.

Press again. After a moment or two, the following message will appear:

System will now restart

**Insert DOS diskette in drive A:
Press any key when ready**

Press . The computer will go through much the same procedure as when you first turned it on. (It is possible you may see some interference on the screen for a few seconds, this is perfectly normal and is not a fault with your PC) Eventually you will see an **A>** prompt.

Now type

FORMAT C: /S (press)

Beginners: In case you are not familiar with using the keyboard, note that to type the characters : and / in the above command, use the following keys:

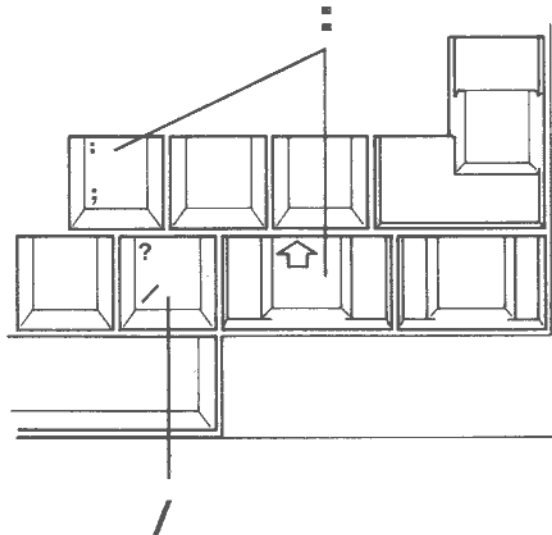

The following message should appear

**WARNING, ALL DATA ON NON-REMOVABLE DISK
DRIVE C: WILL BE LOST!
Proceed with Format (Y/N)?**

Type:

Y (press)

On the screen, you will see:

Head:0 Cylinder: 1

The numbers will change as you watch, and represent how far the computer has got as it prepares the hard disk. The Cylinder number will give you some idea as to how far the process has reached. A 20 Mbyte disk will take about five minutes and count up to cylinder number 610.

When the computer has finished, the message

Format complete

will appear, followed shortly afterwards by something similar to

System transferred

**21309940 bytes total disk space
71680 bytes used by system
21217280 bytes available on disk**

It is possible that the message will indicate a certain proportion of the disk as used in 'Bad Sectors'. This is perfectly normal.

Open the floppy drive by turning the drive handle and then withdraw the disk from the drive. Carefully replace it in its paper envelope. Now remove Disk 4 - 'GEM Output and supplementary Programs' from its envelope, and slide it into the floppy disk drive. Close the door. Now type

SUPPLEME\CONFIG (press)

The computer will now copy information from Disk 4 onto your hard disk. During this copying process both the green light on the front of the floppy disk drive and the red light on the front of the hard disk drive will flash or remain on for long periods. After about a minute the computer will beep and you will see the message:

**Insert Amstrad Disk 1 into the floppy drive
Press a key when ready**

Remove Disk 4 from the drive, replacing it in its envelope, and re-insert Disk 1 into the drive. About a minute and a half later, the computer will beep again and ask you for the next disk. It will do this for Disk 3 as well, taking around a minute for each disk. After you have finished with each disk, replace it in the envelope and put them all somewhere safe. You probably won't need them again, but for safety's sake it's a good idea to keep them where they won't get lost or damaged.

Using the installed operating systems

Now press the **Ctrl**, **Alt** and **Del** keys at the same time. The **Ctrl** and **Alt** keys are next to each other towards the left hand side of the keyboard, while the **Del** key is next to the **Enter** key at the bottom right hand corner of the keyboard. Pressing all three together resets your computer. The computer will behave as if it had just been switched on, and eventually the message:

```
C>ECHO OFF
    --- Installing Mouse Device Driver V5.00 ---
```

C>
will appear.

Type **GEM** and press **↵**

After a short while, you will see a display like this on the screen:

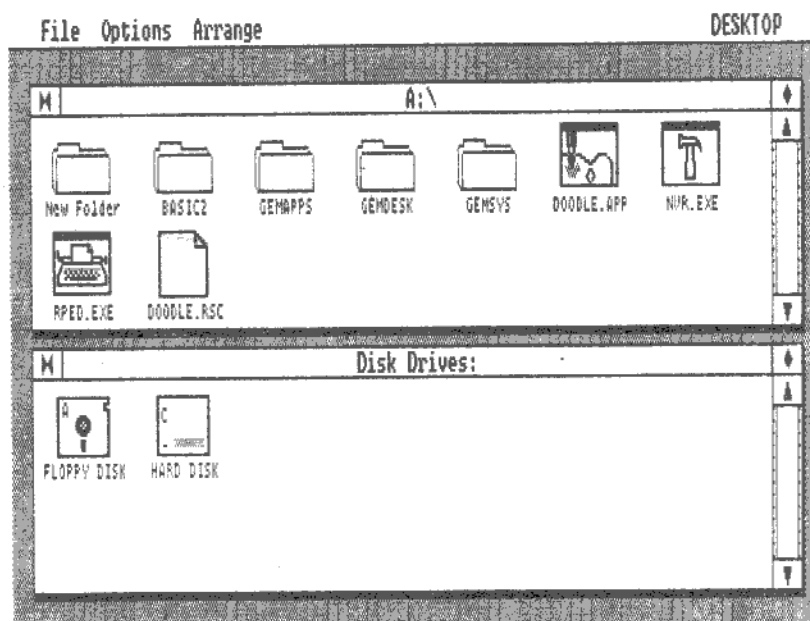

First steps

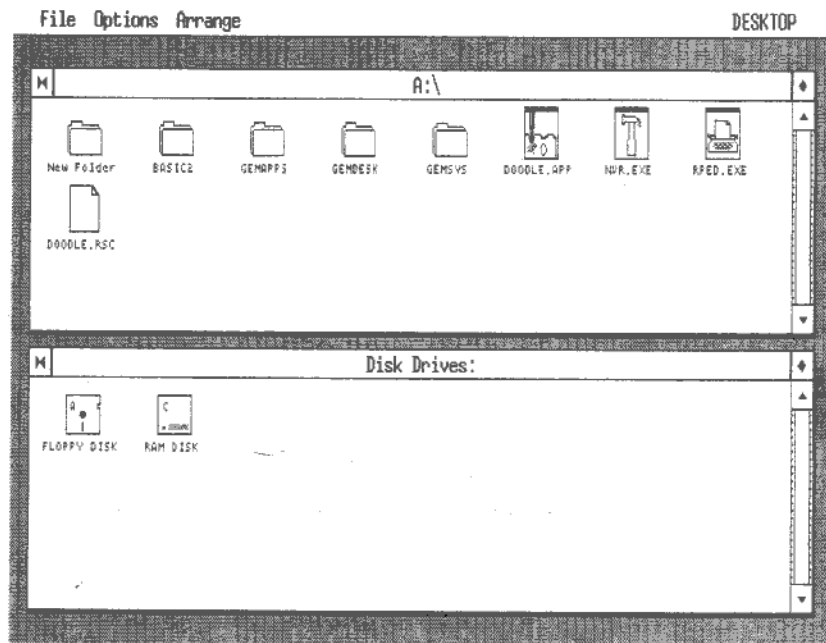

If you have a high resolution display (Colour or Monochrome) you will see the alternative high resolution display shown above.

Note that from now on in this guide all example screens will be shown as Low resolution colour.

Your PC is now ready to use. You can now read the following section

The first item on the screen to work with is the pointer. This is used to point to any object on the screen you are interested in:

You move the pointer by moving the mouse across something solid like the top of your table. Put the mouse down on the table in a clear, dust-free area at least a foot square: if the surface is dusty, the rubber ball in the base of the mouse will get dirty and this will affect how the mouse works. Hold the mouse like this:

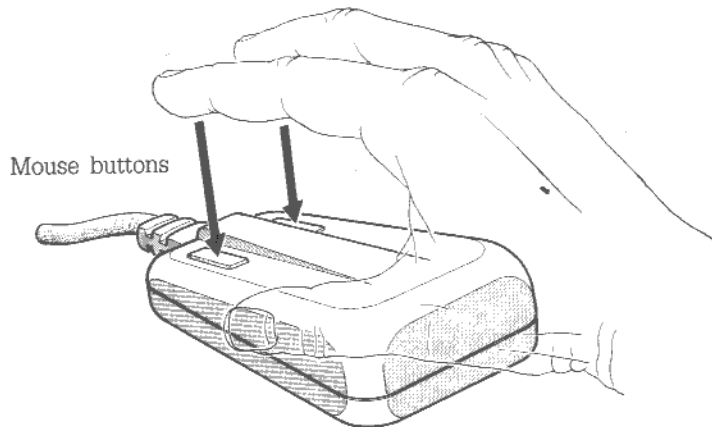

Now gently push it as follows:

- To move the pointer up the screen, push the mouse forward in the direction it is pointing (buttons and cable at the front)
- To move the pointer down the screen, pull the mouse backwards but still along the line of the mouse
- To move the pointer to the right, push the mouse sideways to your right
- To move the pointer to the left, push the mouse sideways to your left

Try moving the mouse in various directions and watch how the pointer follows the movements you make. For the moment, ignore any menus (lists of actions) that suddenly appear on the screen. The fact that they have appeared doesn't alter how the pointer moves and certainly doesn't mean that you have done something you shouldn't.

The pointer won't move if you don't have good contact between the ball in the base of the mouse and the solid surface you are moving it across. Gentle pressure on the mouse as you move it should be all that is needed.

The pointer disappears if you move it too far to the right or too far down. To get the pointer back on the screen, move the mouse round in a circle on the table until you see the pointer re-appear. (The pointer is stopped from going too far to the left or off the top of the screen.)

Using the keyboard

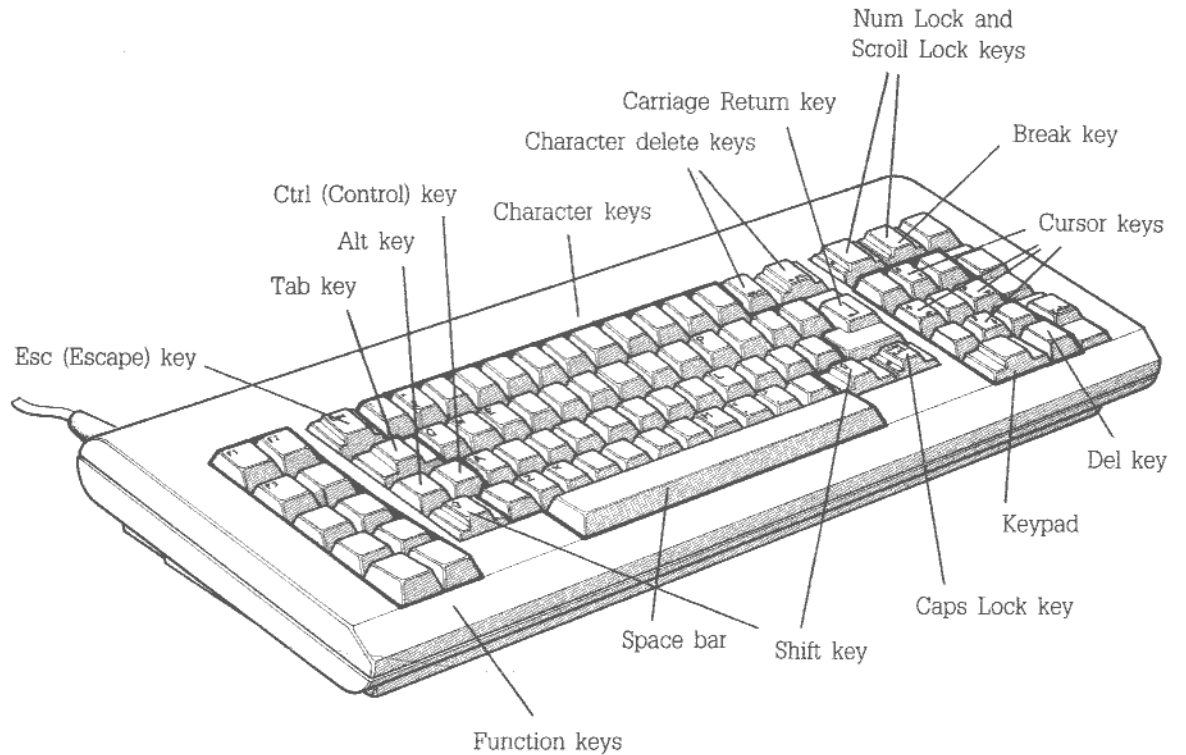

Key

Character keys

Function keys



(known as the Space Bar)

Cursor keys 
  

Use

To enter lower case letters and the lower character written on a key where there are two.

Used with  to enter upper case letters and the upper character written on the key where there are two.

Set up by the programs you run to have actions specific to the program you are running

Enter a space character

Used with other keys to give special characters or special computer codes (described elsewhere). Ctrl stands for Control; Alt stands for Alternative.

Move the cursor on the screen in the direction shown by the arrow. Note: This action isn't available when the keypad is being used (see  below).

Home, **End**, **Pg Up**,
Pg Dn

Used by text editing programs to move the cursor to the beginning of a document, the end of a document, one page further up in the document, and one page further down

↵

Move the cursor to the beginning of the next line; send instructions to your PC; reply to requests for information

→|

Move the cursor to the next Tab Stop, inserting spaces as necessary

<Del

Delete the character to the left of the cursor

Del>

Delete the character under/to the right of the cursor

Esc

Used by programs, for example as the way you indicate that you want to stop using the program. Esc stands for Escape.

Ins

Used to swap between inserting characters into text already on the screen and overwriting existing text, and back again

Num Lock

Used to swap between using the keypad keys to control the cursor and using these keys as a numeric keypad, and back again

Cap Lock

Used to swap between the letter keys producing lower case characters without the **⇧** key and upper case characters with this key, and the opposite pairing. Pressed again to swap back again.

Scroll Lock

Used by some programs to make the cursor keys move the text on the screen behind the cursor, rather than move the cursor over the text. Pressed again to return to normal cursor movement.

Break

Used with **Ctrl** to abandon the program that is currently being run

Prt Sc





Used with **⇧** to print out an image of the screen on your printer. It must not be pressed if you don't have a printer connected to your PC.



Del





Used like **<Del** to delete the character immediately before the cursor. Also used with **Ctrl** and **Alt** to reset your PC.

Note: Not all programs will use the keys in the same way. For example, **<Del** sometimes just moves the cursor back one position; **Del** sometimes deletes the character under/to the right of the cursor; **Del>** may have no effect. With some programs, the cursor keys and the **Home**, **End**, **Pg Up**, **Pg Dn**, **→|**, **Ins** and **Break** keys may have no effect.



Using the keyboard is simply a matter of pressing the keys – either on their own or two or more keys at the same time. Much of the time, you will use keys in the central section of the keyboard. Most of these are 'Character keys' – keys like the keys on a typewriter, which you can use either on their own or with the  Shift key.

When you use them on their own you get lower case (little) letters of the alphabet or the lower of the two characters written on the key. When you press the  key as well, you get upper case (capital) letters or the upper character on the key. For example, pressing the  key on its own gives a 6, but pressing it with  gives ^ . The  key works like a Shift Lock key on a typewriter, but it only affects the letter keys [A]...[Z].

Your PC keyboard also has a number of additional keys. To the left, there are 10 'Function keys' which programs use to give you special facilities. In the main section, you have  and  keys which like the  key are used together with a character key (or some other key on the keyboard) to produce either special characters or special computing codes.

You also have two 'Rub-out' keys  and , a  (Carriage Return) key which takes you to the beginning of the next line, and a special computing key . The Carriage Return key is used to send instructions to your PC and to reply to requests for information.

To the right, you have a set of keys with two roles. Some of the time they control the cursor – the object on the screen that marks where you are working; the rest of the time, they give you a numeric keypad – like you might have on a calculator. Pressing the  key changes the keys from controlling the cursor to producing numbers and back again.

Also notice the  key – which controls whether what you type overwrites what is already on the screen or if what you type is inserted into the text already on the screen, the  key and the  key which have some special uses.

It is a good idea to spend some time getting used to where these keys are. In particular, note that the number 0 is between 9 and – on the top row of keys and the letter O is between I and P on the second row. These characters look similar, both on the keyboard and printed in a book, but they are not interchangeable. Also note the way the special keys are represented in this manual: , for example, means the key marked Ctrl – not the letters C t r and l.

Backing-up your AMSTRAD PC disks

Assuming you have loaded the GEM Desktop, the next task is to produce duplicate copies of the AMSTRAD PC MS-DOS, GEM 'Startup' and 'GEM Desktop' disks (Disks 1, 2 and 3). By doing this, you ensure that you can still use your AMSTRAD PC even if one of these disks becomes damaged or you accidentally erase all its contents. You may also want to produce a duplicate copy of Disk 4.

Note: If you have a Hard Disk PC refer to Chapter 4 section 4.2 for details on how to make backup-copies of files on your Hard Disk.

If you have a Floppy Disk PC insert Disk 1 in drive A (the lefthand drive). Using the Mouse move the pointer to the word 'Options' in the top line of the screen. This brings the GEM Desktop's Options Menu onto the screen. Now move the pointer to the words "Enter Dos Commands" . When these words become highlighted, click the lefthand mouse button once. The screen shown below will be displayed:

A>

What happens next depends on whether your PC has one or two floppy disk drives.

● **If you have a single-drive PC**

Type: **DISKCOPY A: A:**

and then press the  key.

Note: You will need to work through the following instructions a number of times – one set to copy Disk 1 and one set each to copy Disks 2 and 3.

After a short while, you will see the following message on the screen:

**Insert SOURCE diskette in drive A:
Press any key when ready**

Your Source disk is the disk you want to copy, ie. Disk 1 the first time you work through these instructions; Disk 2 the second time. Drive A is your disk drive.

Open the drive by turning the drive handle anticlockwise and then withdraw the disk completely from the drive. Stick a small sticky label over the square notch in one edge of this disk (Disk 1). Take Disks 2 and 3 out of their paper covers and then cover the notches on these disks in the same way. This action protects the disks against possible accidents while copying the disks.

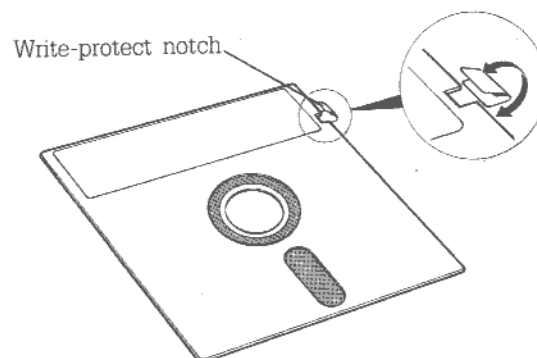

Now slot the disk you want to copy into your drive (label uppermost) and turn the drive handle clockwise to close the drive. Then press the  key. You should see the green indicator light on the drive come on for a while.

After a short pause, you will see the message:

**Copying - 40 tracks
9 Sectors/track, 2 side(s)**

followed by:

**Insert TARGET diskette in drive A:
Press any key when ready**

The Target disk is the disk you want to store the copy on, ie. one of your three new blank disks.

Open the drive by turning the drive handle anticlockwise and withdraw the disk you are copying. Take a new blank disk from its paper cover and slot it into the drive (label uppermost) and close the drive by turning the drive handle back across the drive slot. Then press the key. Again, the green indicator light should come on.

Because your target disk is new, you will see the following message on the screen:

Formatting while copying

This is perfectly normal. It just tells you that your PC is marking out your disk into storage segments at the same time as making the copy.

Finally you will see the message:

Copy another diskette (Y/N)?

When this message appears, open the drive by turning the drive handle and remove the disk from the drive. Write 'Disk 1: AMSTRAD MS-DOS', 'Disk 2: AMSTRAD GEM Startup Disk' the second time, 'Disk 3: Desktop Disk' the third time on a blank disk label and then stick it on the disk, next to the manufacturer's label. If the blank label is already on the disk, write with a felt tip pen and don't press hard as you write - you could damage the disk. Then put both the disk you copied and the freshly made copy back in their paper covers.

If you have only copied one disk so far, type and then copy Disk 2 by using the same procedure. Don't type **anything** yet if you have copied all three disks: just move on to reading where it says 'When you have made the copies'.

● **If you have a two-drive PC**

Type: **DISKCOPY A: B:**

and press the key

After a short while, you will see the following message on the screen:

**Insert SOURCE diskette in drive A:
Insert TARGET diskette in drive B:
Press any key when ready**

Your Source disk is the disk you want to copy, ie. Disk 1 the first time you work through these instructions; Disk 2 the second time. Your Target disk is the disk you want to store the copy on, ie. one of your three new blank disks. Drive A is your lefthand disk drive; Drive B is your righthand disk drive.

Open your lefthand drive by turning the drive handle anticlockwise and then withdraw the disk completely from the drive. Stick a small sticky label over the square notch in one edge of this disk (Disk 1). Take Disks 2 and 3 out of their paper covers and then cover the notches on these disks in the same way. This action protects the disks against possible accidents while copying the disks.

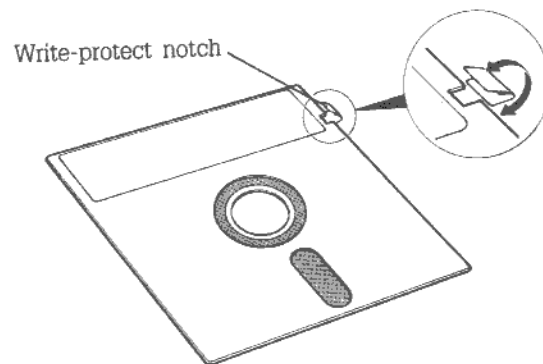

Now slot the disk you want to copy into your lefthand drive (label uppermost) and turn the drive handle on this drive clockwise to close it. Then slot one of your new blank disks into your righthand drive (label uppermost) and turn the drive handle on this drive clockwise so that it is across the drive slot. Finally, press the key. You should see the green indicator lights on both drives come on for a while.

After a short pause, you will see the message:

**Copying - 40 tracks
9 Sectors/track, 2 side(s)**

Because your target disk is new, you will see the following message on the screen:

Formatting while copying

This is perfectly normal. It just tells you that your PC is marking out your disk into storage segments at the same time as making the copy.

Finally you will see the message:

Copy another diskette (Y/N)?

When this message appears, open the drive by turning the drive handle and remove the disk from the drive. Write 'Disk 1: AMSTRAD MS-DOS', 'Disk 2: AMSTRAD GEM Startup Disk' the second time, 'Disk 3: Desktop Disk' the third time on a blank disk label and then stick it on the disk, next to the manufacturer's label. If the blank label is already on the disk, write with a felt tip pen and don't press hard as you write - you could damage the disk. Then put both the disk you copied and the freshly made copy back in their paper covers.

If you have only copied one disk so far, type and then copy Disk 2 by using the same procedure. Don't type anything yet if you have copied all three disks.

● **When you have made both copies**

Store the originals of the two disks you copied safely away. These are then your Master set, only to be used to make further copies (by repeating the above procedure) if one of the copies you have just made becomes damaged. Keep their notches covered up so that you can never accidentally erase their contents. Use the copies in your daily use of your AMSTRAD PC.

Put your new Disk 3 in Drive A (your lefthand drive if you have two), turn the drive handle across the drive slot and then press the **N** key.

Type

EXIT and press 

Note: For details on how to make backup copies of the Hard Disk refer to Chapter 4 section 4.2.

You have now completed all the preparatory work you need to do, and you could now go on to running programs. But unless you plan to use your AMSTRAD PC simply to run standard commercial DOS programs, we would recommend you to carry on following the instructions in this chapter. These describe running a program called 'DOODLE'. As well as being fun to use, this provides an excellent opportunity to learn how to use the features of GEM. (Later, when you want to produce pictures, you will probably use the more sophisticated GEM PAINT program introduced in Chapter 5.)

Learning more about the system

1. Finding your way about

Before running DOODLE, it is worth learning a little bit more about what you can do with the GEM Desktop displayed on the screen. What we are going to do is change the set of icons displayed in the lower window of the screen. The actions we will take work just as well on the upper window but if you leave this window alone for now, you can guarantee being able to find DOODLE when it comes to running this program.

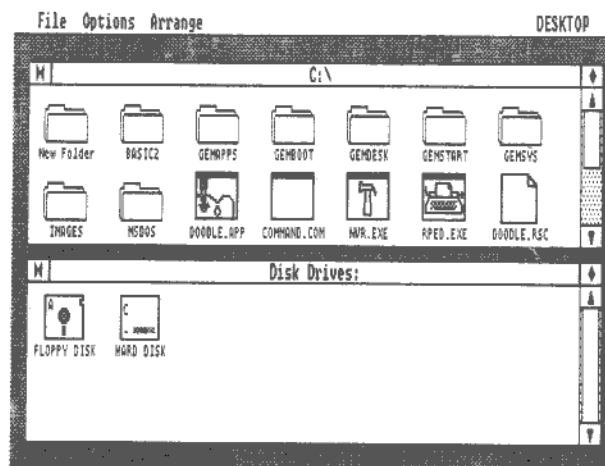

The lower window has the title 'Disk Drives' and contains either two or three 'icons' (ie. stylised pictures of disks). Whatever version of AMSTRAD PC you have, you will see two icons, one of which will be a 'Floppy Disk' icon with the letter 'A' on it. If you have a two-drive system, the second icon will be another floppy disk icon - with the letter 'B' on it. The other icon represents a built-in disk, either a hard disk or a special area of your computer's memory (RAM) that can be used to store program and data files. If you have a hard disk, then you should replace the 'A' in the following examples with 'C'.

Move the pointer to the floppy disk 'A' icon by moving the mouse in the appropriate direction on your desk and then double-click the lefthand button on your mouse. You will remember that the technique called 'double-clicking' involves pressing and releasing the mouse button twice in quick succession.

You should see a fresh set of icons being displayed in the window. If the disk icon merely becomes highlighted (ie. its outline is redrawn using thicker lines and its title is rewritten in light characters against a dark background) just keep the pointer on the disk icon and keep trying. Try varying the speed at which you double-click the lefthand mouse button.



Folder



Program



Document

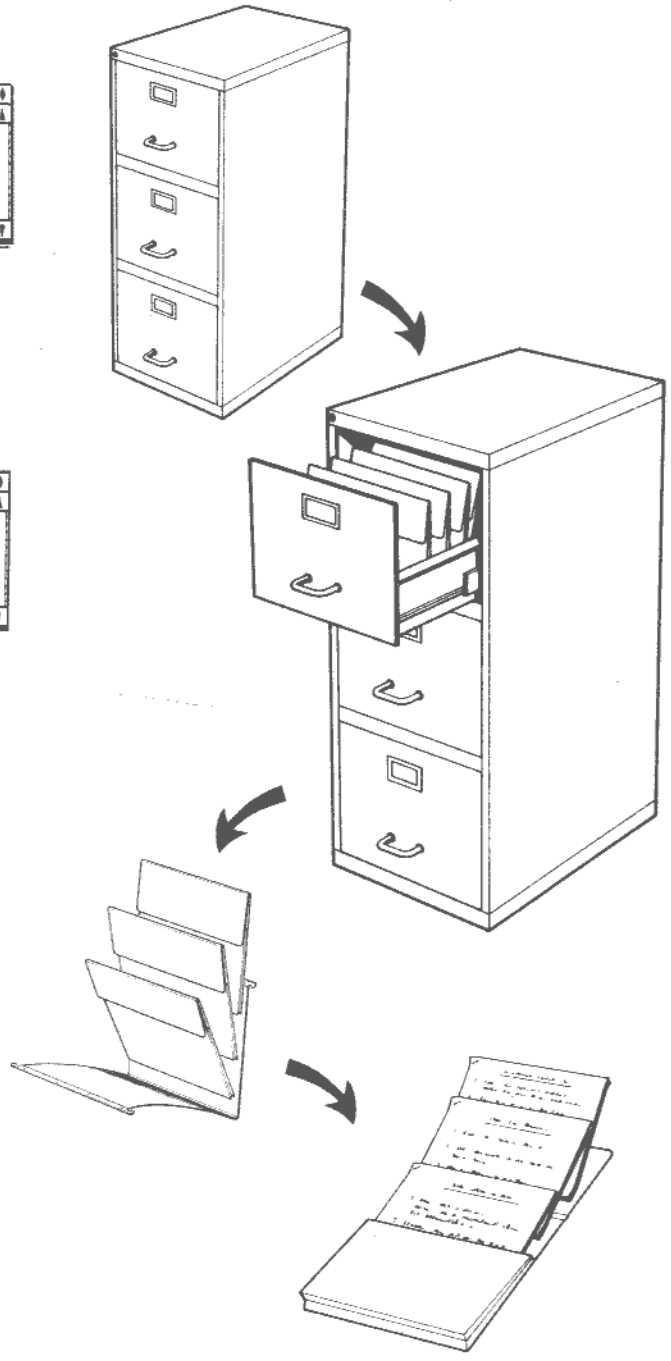
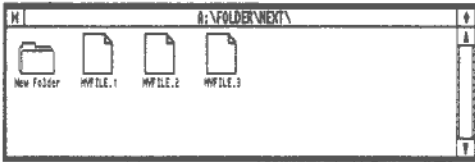
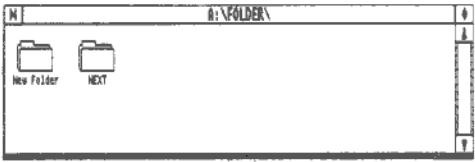
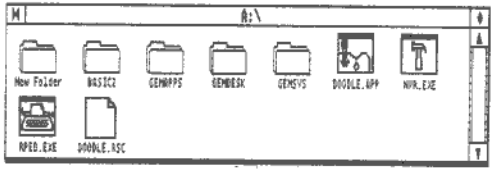

The icons now on the screen display the contents of the disk you have just 'opened' in the form of a set of folders (ie. the 'outer containers' of individual groups of programs and data files), together with some programs and data files. These summarise all the contents of this disk and make up what is known as the 'Root Directory' of the disk. (If these ideas are strange to you, either go back and read Chapter 1 now or make a note to go back and read it when you have finished working through this chapter.)

If you compare what is now displayed in your two windows, you will see that these now show exactly the same information. In other words, when you start up the GEM Desktop it automatically displays the Root Directory of Drive A in the upper window. This is confirmed if you look at the top line of each box (called the Title Bar): both have the title 'A:\'. A title that is a letter followed by '\ ' always indicates the disk's Root Directory.

Now move the pointer to the icon with the name BASIC2 underneath it. This is a folder icon, ie. it represents a group of programs and data files. Now double-click the lefthand mouse button: if the icon merely becomes highlighted, try again until you succeed in changing the icons displayed in the window.

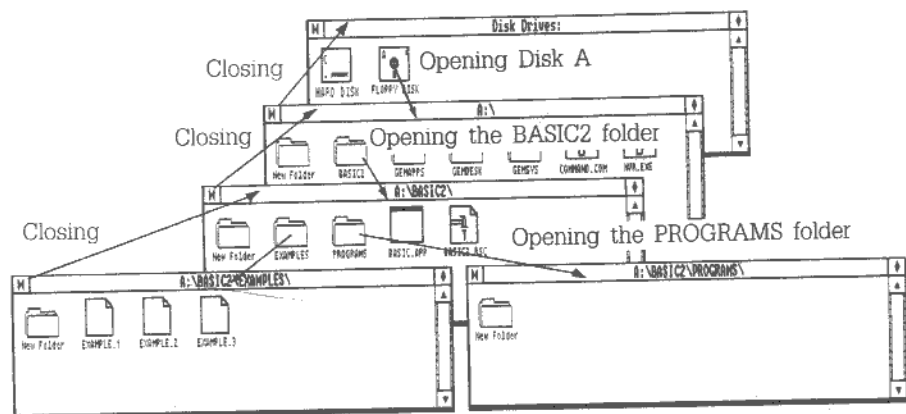

If you now look at the title bar, you will see that what is currently on the screen is called 'A:\BASIC2\'. In other words, you are now seeing what the BASIC2 folder on Drive A contains. As you see, this also contains a few folders, some programs and some data files.

If you move the pointer to the EXAMPLES folder icon now on the screen and double-click the lefthand mouse button, you will see a new set of icons on the screen representing the contents of the EXAMPLES folder. Its title will be 'A:\BASIC2\EXAMPLES\'. Note how opening the new folder has added another section to the title. What the title is doing is recording everything you have opened in order to reach the current display. In other words, it maps out the 'path' you take from the Root Directory.

To go back to the A:\BASIC2\ folder, move the pointer to the box on the top line of the window with the 'bow tie' in it. This is called the window's 'Close Box'.

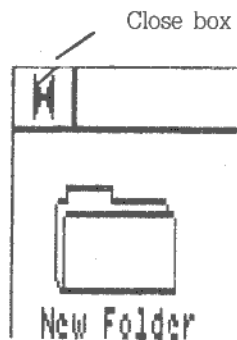

Now click the lefthand mouse button once. You will see the window change to display the A:\BASIC2\ folder again. Note how using the close box shows the folder mentioned second to last in the title of the window you have just closed. You can think of closing a window as taking a step back along the path outlined by the title, just as opening a folder was taking a step forward.

You can now move the pointer to a different folder in the window – say, the PROGRAMS folder icon – and double-click on that to see what its contents are. And having displayed them, you can again return to the A:\BASIC2\ folder by moving the pointer to the window's close box (the 'bow tie') and clicking the lefthand mouse button once.

To get back to the Root Directory from the A:\BASIC2\ directory, simply move the pointer to the window's close box and click the mouse button once. Again, what you are doing is simply taking a step back along the path. As you might expect by now, to get back to the display of disk drives, you just move the pointer once again to the close box and click the lefthand mouse button. This is the furthest back you can go.



Spend some time opening folders by double-clicking the lefthand mouse button while pointing to their icons (or the floppy disk if you get back as far as the 'Disk Drives' window) and closing windows by clicking the mouse button while pointing to the close box until you feel confident of being able to move from one folder to another and back again. Choose folders with names underneath: don't choose the 'New Folder' folder. Also be very careful at this stage to point only at folder icons.

2. Running the DOODLE program



We now go on to using the DOODLE program. Turning to the top window (which should still be displaying the Root Directory of Floppy Disk A), find the program icon called DOODLE.APP.

Move the pointer to the icon and then double-click the lefthand mouse button. An hour glass will appear briefly, and then a new window will be displayed – a blank window with the title 'Dr Doodle for the Amstrad PC'. You are now working with the DOODLE program.

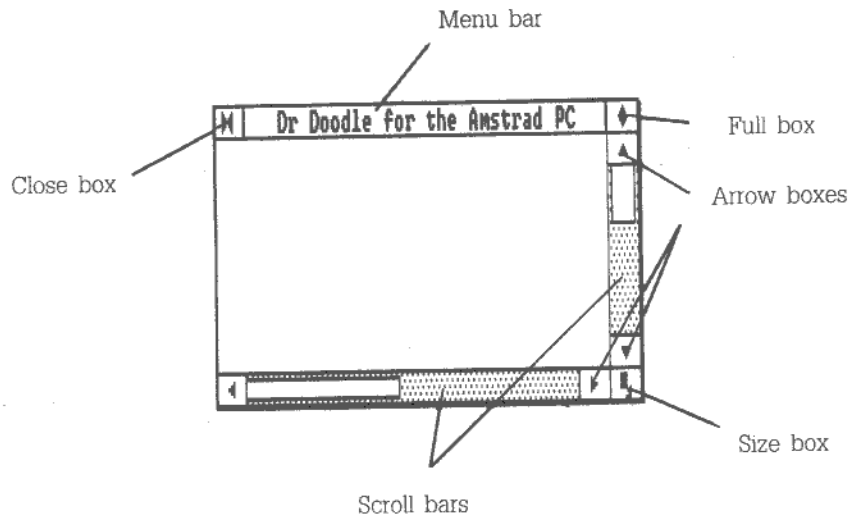

What the DOODLE program gives you is some tools which you can use to create a picture. Some of these tools are already to hand. Try typing something like 'Hello Fred!' and try the effect of holding down the lefthand mouse button while you move the mouse over your desk. (Don't worry about keeping the pointer within DOODLE's window as you draw: lines, etc. are only drawn within the window.) Another option to try is moving the mouse, then clicking the lefthand mouse button, and then doing this again. In this way, you can create a simple 'doodle'.

3. Seeing more of the doodle



Size box

Down at the bottom righthand corner of the window is a small box with a black square and an arrow in it. This is called the Size Box. Move the pointer to this box and then press and hold down the lefthand button on the mouse. Now, still holding the mouse button down, move the pointer with the mouse to some other part of the screen. You will see a shadowy outline of a window following the movements of the pointer. This is showing you the size of window suggested by the current position of the pointer. Release the button and you will see the window redrawn properly this size.

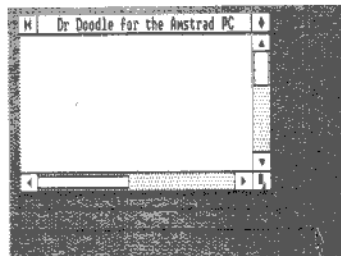



Experiment with this technique and different sizes of window. Notice how the amount of the doodle shown changes, but 'Hello Fred' (for instance) stays the same size and doesn't move.

Another way of changing the size of the window is to use the box at the top righthand corner of the window with the small black diamond in it. This is called the Full Box. Move the pointer to this box and then click the lefthand mouse button once. The window immediately opens up to cover the full screen. Again, notice that the amount of the picture shown has changed - not the size of the picture.

If you move the pointer to the Full Box of the new window and click the lefthand mouse button, the window will return to its previous size. Try this a few times but take care to click only when the pointer is actually on the Full Box. Otherwise, you won't see the effect. Finish with the window occupying only part of the screen.

Note: The DOODLE window has both a Size Box and a Full Box. Other windows may only have a Full Box, while yet others have neither. If a window only has a Full Box, it can only be one of two sizes - full screen or, say, half the screen. If the window does not have either box, its size is fixed.

4. Changing where the doodle is

To change where the doodle is on the screen, you simply have to change the position of the window. To do this, move the pointer to the top line of the window - the Title Bar - and then press and hold down the lefthand button on the mouse. Without releasing the mouse button, move the pointer to some other part of the screen.

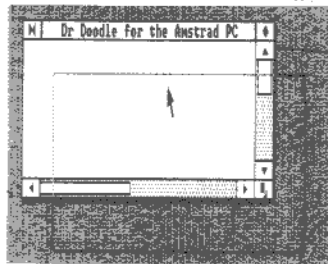

Original position
of window

You will see an outline of the window following the pointer. This marks out for you the position of the window suggested by the current position of the pointer. When you release the mouse button, the window will be redrawn within this outline. Notice how the same part of the doodle is redrawn in the window. Practise moving the window to different positions, but be careful not to move the window outline off the bottom righthand corner of the screen in such a way that only the box with the 'bow tie' remains visible. You won't be able to get it back if you release the mouse button.

(If you do do this, move the pointer to the bow tie and click the lefthand mouse button once. This returns you to the GEM Desktop. Point to the DOODLE.APP icon and double-click the lefthand mouse button to start using the DOODLE program again.)

Note: You won't always be able to move a GEM window. Some windows are fixed in their position.

5. Moving the doodle about in the window

Your window is only showing part of the page you can doodle on (indeed, that's why it is called a window - you look through it onto something bigger). You can see other parts of the page without changing the size of the window by using the window's 'Scroll Bars' and 'Arrow Boxes'.

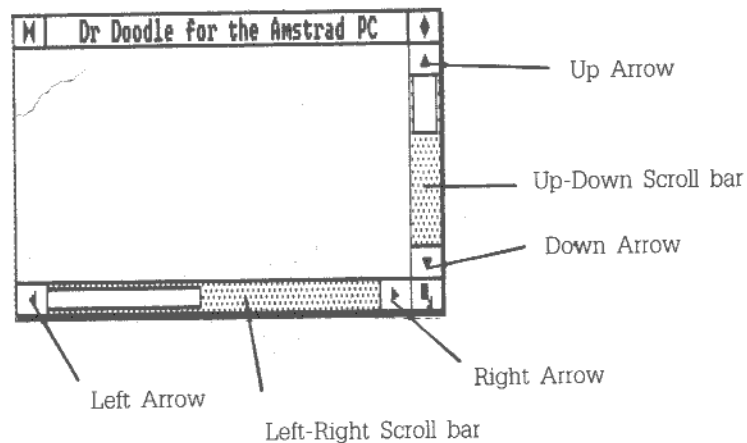

A look at the two scroll bars of a window will always tell you how much of the page is actually being shown on the screen. If the vertical scroll bar is blank, you are seeing the full depth of the page and if the horizontal scroll bar is blank, you are seeing the full width of the page, but if any part of either scroll bar is shaded, then you are only seeing part of the page.

The position of the unshaded part of the scroll bar shows which section of page is displayed. If this is at the top, you are looking at the top section of the page; if this is at the bottom, you are looking at the bottom section; and if this is part way up, you are looking at a section in the middle. The size of the unshaded part is in proportion to the amount of the page that is being displayed. If it is small, only a small part of the page is being shown.

Use the size box to change the size of the window until part of both scroll bars is shaded. Now move the pointer to the 'Down' arrow box below the vertical scroll bar. Click the lefthand mouse button once. You will see the contents of the window move up a short way. If you hold down the mouse button, you will see the window move up in steps. This movement of the contents within the window is called 'Scrolling'.

A quicker way of 'scrolling the window' is to move the pointer to a shaded section of the scroll bar and then click the mouse button. This has an effect similar to winding the film on to the next frame on your camera. The current display winds off the window to allow the next section of the page to be displayed. Try this with any shaded area in your scroll bars.

The third way of changing what is shown is as follows. Move the pointer to the unshaded part of a scroll bar and then press and hold down the lefthand button on the mouse. Now move the pointer along the scroll bar towards a shaded area. You will see an outline of the unshaded part follow the pointer.

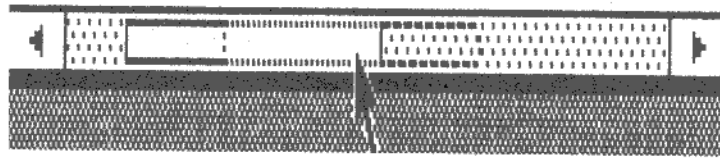

Release the mouse button and you will see both the screen and the scroll bar being redrawn. The position you selected for the unshaded section of the scroll bar set which part of the picture was drawn on the screen.

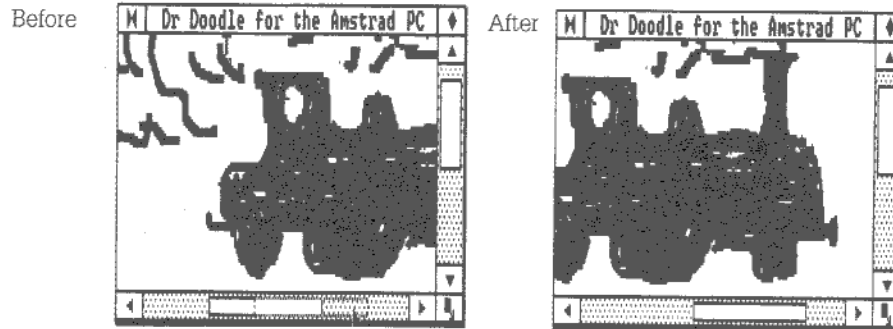

Try out all these different ways of changing what is displayed in the window.

6. A more sophisticated doodle

So far we haven't made any real use of the DOODLE program's facilities. These are summarised in menus, the titles of which are given in the top line of the screen (the Menu Bar). First we will clear away the rubbish doodle we have created so far.



Use the mouse to move the pointer to the word 'Options' in the Menu Bar. You will immediately see the 'Options' menu appear on the screen. Now, move the pointer to entry in this menu 'Erase Picture' - you will see this become highlighted when the pointer reaches this entry. Click the lefthand button on your mouse once **when 'Erase Picture' is highlighted** and you will see the picture on the screen disappear.

If 'Erase Picture' wasn't highlighted when you clicked the button, you will either see what is called a 'Dialog box' with the title 'Pen/Eraser Selection' in the middle of the screen (press and try again), or you will lose the DOODLE window and return to the Desktop (double-click on DOODLE.APP again), or the menu will just close up - depending on where the pointer really was and so what action was selected.

When you are familiar with all the possible actions you can carry out with DOODLE, missing the right entry in a menu can cause just a frustrating setback. When you have yet to learn how to use all the program's features, it can be disastrous. So do make sure that you **only click the mouse button when the option you want is highlighted**.

We will now create a rather more sophisticated doodle than we did before. First we will select the pen to draw with - we can choose both the thickness of the line it draws and its colour (on a colour PC) and intensity.



Once again, use the mouse to move the pointer to the word 'Options' in the Menu Bar: this brings the 'Options' menu onto the screen. Move the pointer to the entry 'Pen/Eraser Selection...' and click the lefthand mouse button when this entry is highlighted.

This results in a box entitled 'Pen/Eraser Selection' appearing in the centre of the screen. The box tells you:

- on the Pens line, what different pens you can use
- on the Erasers line, what different rubbers you can use
- on the Pen Colors line, the code number of colour you are currently using. Note that on the PC MD there are only two colours.

The thin box on the 'Pens' line picks out the pen thickness you are currently using.

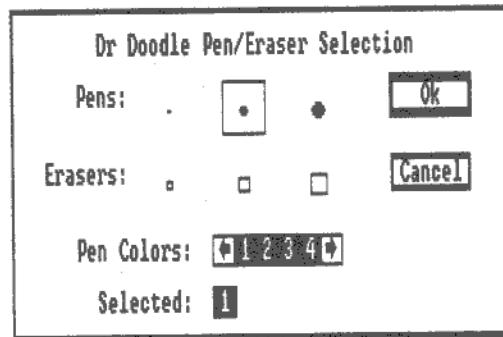

To change the pen you are using, move the pointer to one of the other two pen thicknesses on the Pens line – point to the thinner one if you would like a finer pen line, but to the fatter one if you would like a thicker pen line. Click the lefthand mouse button. Instantly, the thin box moves to surround the pen thickness you have just chosen. Use the same technique to move the box back again or to the other option or to the Erasers line. You can do this as many times as you like – but do finish with the option you would like to use.

To change the colour on a PC CD or PC ECD, move the pointer to one of the numbers in the block of four and click the lefthand mouse button. Immediately the number in the box on its own will change to the number you have just selected. Use the same technique to change the number again. Also try moving the pointer to one of the arrows at either end of this block of numbers and clicking the lefthand mouse button a number of times. Then, do the same with the other arrow. As you see, there aren't just four but 16 different colours available – each with a different code number. As with the pen thickness, you can change your selection as many times as you like – but do finish with the number in the box you would like to try.

When you are happy with your selection, move the pointer to the little box marked 'OK' and click the lefthand mouse button. If instead you would rather to go back to the pen that you were originally working with, move the pointer to the little box marked 'Cancel' and click the lefthand mouse button: this throws away the selections you have just made and returns you to the original pen.

Add to the current doodle with this pen – by either typing characters in, holding down the lefthand mouse button to draw lines or clicking this button to put dots on the screen. Then change your pen again, and add to the doodle some more.

7. Leaving DOODLE

When you have experimented enough with DOODLE, move the pointer to the word 'Options' in the Menu Bar and this time move the pointer to the 'Quit' option in the Options menu. When you click the lefthand mouse button this time, you will leave DOODLE and return to the GEM Desktop.

You can also leave DOODLE by moving the pointer to its window's Close Box - that is, the box in the top lefthand corner of the window with a 'bow tie' in it - and then clicking the lefthand button on the mouse once.

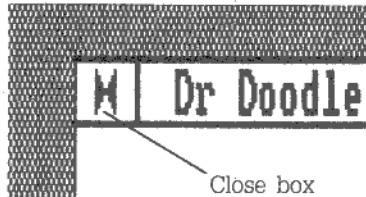

If you would like to try this, move the pointer to the DOODLE.APP icon on the GEM Desktop again and double-click the lefthand mouse button to bring the DOODLE window back onto the screen. Then move the pointer to the Close Box (the bow tie), click the lefthand mouse button and see how this returns you to the Desktop again.

Switching off

For the sake of practice, the next thing to do is to go through the correct Switching-off procedure.

Turn the drive handle(s) on your disk drive(s) anti-clockwise to release the disk(s) and then withdraw the disk(s) completely. Replace the disk(s) in their paper covers. Then press the Power Button on the back of the Display to switch off.

If you want to carry on working with your AMSTRAD PC, turn to Section 8.1 and work through the Startup procedure given there. Then if you want to go straight on to running programs on your PC, turn to Chapter 5.

REMEMBER: ALWAYS REMOVE YOUR DISK(S) FROM THE DISK DRIVE(S) BEFORE YOU SWITCH OFF AND DON'T FORGET TO MAKE BACKUPS OF IMPORTANT DISKS.

FOR DETAILS OF HOW TO MAKE BACKUP COPIES OF FILES ON THE HARD DISK REFER TO CHAPTER 4 SECTION 4.2. IF YOU WISH TO MOVE THE PC THEN YOU MUST "PARK" THE HARD DISK MECHANISM'S READ/WRITE HEADS. HOW TO DO THIS IS EXPLAINED IN CHAPTER 4 SECTION 4.2.7.

4. ABOUT DISKS

4.1 FLOPPY DISKS

Included with your AMSTRAD PC are four floppy disks containing some programs for you to use. As you use your AMSTRAD PC more, you will want to buy further programs on floppy disks and you will need to buy a number of new blank floppy disks – for storing data, for storing duplicate copies of the programs you buy, and even your own programs.

This section describes what type of floppy disks you should use in your AMSTRAD PC and how to handle them, also, how to make backup copies of your disks.

Because disks can become damaged, it is good practice to keep 'security' copies of as many of your disks as you can, starting with the disks supplied with your PC. (Note: Some of the programs you buy may be protected against copying and you won't be able to make direct copies of these disks. Refer to the program's own user guide for details of how to make a security copy of this program.)

The instructions for copying programs from one disk onto a fresh disk are given in Section 6.1 (using the GEM Desktop) and Chapter 7.1 (using MS-DOS commands).

4.1.1 What type of disks?

The AMSTRAD PC's built-in floppy disk drives can only accept 5¼ inch floppy disks.

Floppy disks are themselves thin and circular (as their name suggests). They are perhaps the most sensitive parts of your computer system and so they are enclosed in a square plastic outer casing to protect them.

There are many different kinds of computer disk, so when buying blank disks or programs on disk you should check that you buy the right sort.

The disks you need are:

- Double-sided
- Double-density
- 48 tpi
- Soft-Sectorred

We recommend you use labelled disks from any leading manufacturer. Using cheap, unlabelled disks can be a false economy and should be avoided. Data transfer between such disks can be unreliable and, in the worst case, their use can damage your disk drives and possibly all the other disks you try using in the drives.

Read the cartoon sheet that accompanies this manual: it contains useful information on buying and using disks for your AMSTRAD PC.

Note: Any blank disks you buy need to be prepared before you can use them to store any programs or data. This process is called formatting. It is done automatically when you copy a disk onto a new blank disk, but you have to format specially any new disk you want to have ready for storing the data files your programs produce. How to format a disk is described in Section 6.2 (using the GEM Desktop) and Section 7.2 (using an MS-DOS command).

The important features of a disk

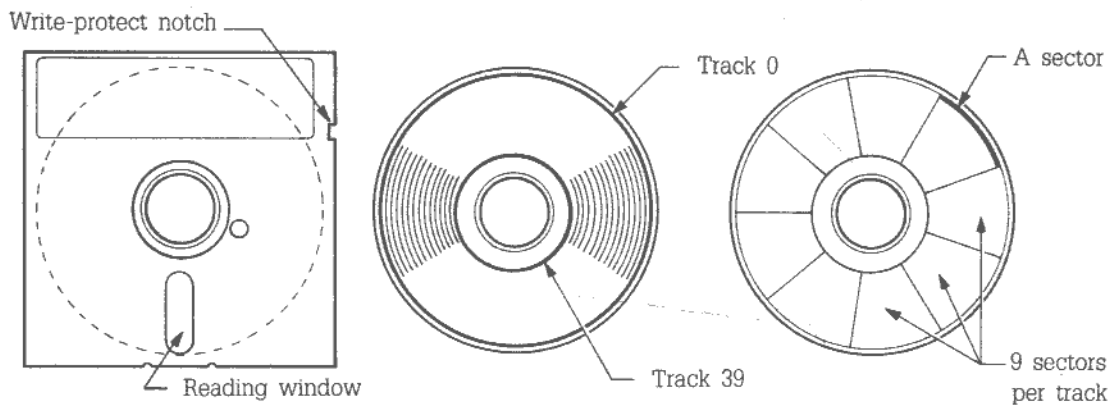

The first thing to notice about a 5¼ inch floppy disk is that it has a front and a back. The front has the manufacturer's label on it and is seamless; the back shows the seams in the disk's plastic casing. Disks are always put into the AMSTRAD PC's drives with the front of the disk uppermost.

The other features are:

The Reading Window: This window is the gap in the packaging through which the computer reads and writes data on the disk. You must be particularly careful never to touch the disk through this window (or the similar window on the back face of the disk): even the grease on your hands can spoil the data stored on the disk.

The Write-Protect Notch: If this notch is open, your AMSTRAD PC is able to both read data from the disk and write data to it. If there is no Write-Protect notch or the notch has been covered over, the PC will be able to read data from the disk but it won't be able to write data to it. Such a disk is described as write protected.

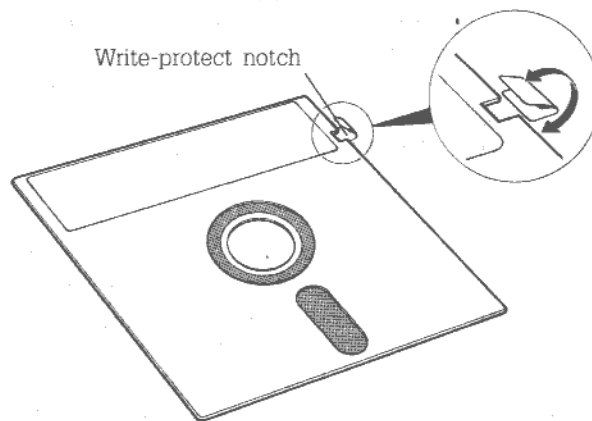

Some of the software disks you buy will have no write-protect notch. Don't try making a write-protect notch in the disk casing: you will probably damage the disk.

A quick, easy and reliable way of making sure that all the data on a disk will not be accidentally overwritten or erased is to stick a small sticky label over the write-protect notch. However, if your program tries to store any information on a disk while it is write-protected in this way, the program will fail.

Tracks and Sectors: These are the divisions into which the data storage area of the disk is divided so that information can be stored on the disk. The tracks are numbered from 0 to 39 and the sectors from 1 to 9.

Most of the time you use your PC, you have no need to know how the data storage area is divided up. We have included this information because if your PC encounters a problem in reading or writing data in a particular part of the disk, it may tell you where the problem is by giving its track and sector numbers. Alternatively, you can find out where the problem is by 'Verifying' the disk. (How to verify a disk is described in Part III, Section 6.3 (using the MS-DOS operating system).

If you experience such problems repeatedly in the same track and sector of a disk, this is a sure sign that the disk has been damaged and we would advise you to copy what information you can onto another disk and then stop using the damaged disk.

If you find that a number of disks are becoming damaged in this way, check with your dealer that your disk drive isn't damaged.

4.1.2 How to handle disks

The thing to remember about your disks is that they are highly sensitive – to scratches, to dust, to temperature, to moisture and to magnets. So:

- Don't try to force open a disk's plastic casing or poke anything into it
- Don't store disks anywhere they could get damp or hot or cold

- **Don't store disks anywhere near a magnet:** that includes the magnets within such pieces of equipment as the loudspeakers of your audio equipment, your telephone or your TV
- **Never put disks into your PC's floppy disk drives before you switch on and never turn your PC off with any disk still in a floppy disk drive**
- **Never take a disk out of a drive while your PC is reading from it or writing to it**

(You can tell if your PC is writing or reading a disk because the light on the disk drive will either be fully on or flashing on and off.)

- **Always write on the disk label before sticking this on the disk – or if the label is already on the disk, write with a felt-tip pen and don't press hard**

Treat floppy disks with due respect and you will get good service from them.

4.1.3 Inserting a disk into a floppy disk drive

Note: Never insert a floppy disk into a drive before switching your PC on. Always switch on first.

- 1 Check that there's nothing in the drive and the drive is open (the drive handle not across the drive slot).**
- 2 Withdraw the disk you want to use from its paper cover.**
- 3 Hold the disk by its labelled end with the label uppermost.**
- 4 Insert the disk fully into the drive slot.**

The disk should simply slide in. If the drive appears to be resisting the disk, stop and try again. If you continue to have problems inserting the disk, consult your dealer. Whatever you do, don't force your disk in.

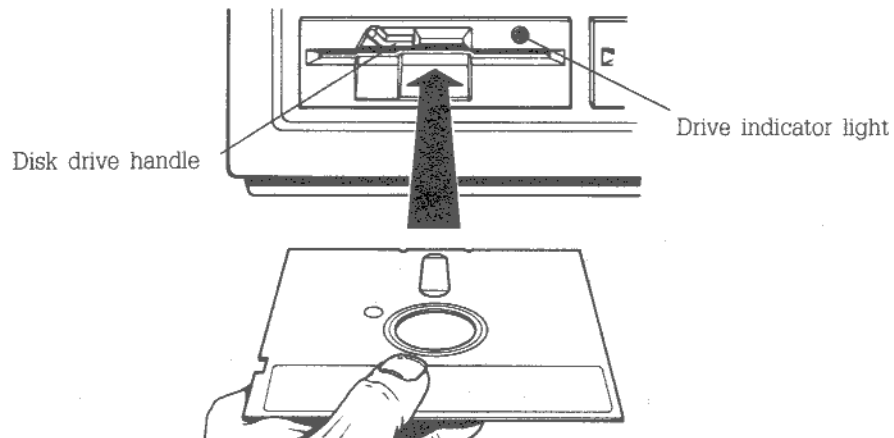

Note: If the instructions tell you to put a disk in Drive A, this means your floppy disk drive – or your lefthand drive if you have two floppy disk drives. The righthand floppy disk drive on a two-drive system is referred to as Drive B.

5 Turn the drive handle clockwise across the drive slot to close it.

4.1.4 Releasing a disk from a floppy disk drive

Note: Never release a disk from a drive while your PC is either reading data from the disk or writing data on it. Not only could the data on the disk be damaged but the disk itself could suffer. You can tell if your PC is using the disk because the green indicator light on the drive will be either fully on or flashing on and off.

Always release all disks from your floppy disk drive(s) before switching off.

- 1 Open the drive by turning the door lock anticlockwise so that it is no longer across the drive slot.**
- 2 Withdraw the disk from the drive slot.**
- 3 Put the disk back in its paper cover.**

4.2 HARD DISKS

4.2.1 General Operation of the Hard Disk PC

The hard disk option provided with your AMSTRAD PC allows you to store a large number of programs and a large amount of data. A great benefit which results from the use of a hard disk is that all your programs are immediately available, without the need to swap floppy disks. It is easy, however, for the hard disk to become 'untidy', with programs and data very difficult to manage; unless it is organised properly. You are advised to study sections 6 and 7 which are concerned with Organising your disks.

Safety first

Your hard disk has been designed to be extremely reliable and to have a long life. However, like all mechanical devices it is possible that it could break down, or be damaged by misuse or accident. There's also the possibility that the wrong command could be typed, and data lost. The hard disk itself can always be repaired or replaced if it goes wrong; what is potentially much more serious is the loss of data that might occur after such a mishap. Ten or twenty megabytes can easily represent years of work, irreplaceable financial records, or invaluable customer records.

This problem has existed ever since the start of computing. A process called 'backing-up', or 'making a backup' has been evolved by professional computer users. A 'backup' is jargon for a copy made for safety's sake. Backups can be made of the entire hard disk every day (or even more often), or just a file or two every week or fortnight.

In general, backups are made by copying files from the hard disk onto floppy disks, as this doesn't need any extra equipment and is quite convenient. Often, however, backups are made with the help of additional tape-based hardware. If you have such equipment, follow the instructions supplied with it.

Backups can be quite time-consuming, and you should weigh up the advantages of security against the time taken creating the backups. For example, if you're writing a book using your AMSTRAD PC, the loss and subsequent retyping of a morning's work might be an acceptable risk. Anything more than a day's work lost would probably be unacceptable – in such a case, you would want to make a backup daily, (ie. at the end of each day's work).

Making backups demands a certain amount of discipline, although every effort has been taken to keep things as simple as possible. You will also need a number of blank (ie. formatted) floppy disks. At first sight, backing-up a twenty megabyte hard disk onto floppy disks seems an awesome undertaking. After all, the hard disk has the capacity of some sixty floppies, and since each floppy can take over a minute to write it could seem that backing-up would take at least an hour. Fortunately this is often not the case. The BACKUP program you are supplied with has various labour-saving options. You can just copy parts of the hard disk, or files that have been changed since the last backup. You also won't need to backup any programs that originally came on floppy disks (as long as you keep the originals somewhere safe) because you can always reinstall them. But you should keep backups of any information you generate.

Exactly of what, and how frequently, you make backups is therefore up to you. A popular method is to have five disks, one for each working day, onto which that day's work is backed-up. Then at the end of the week, everything important is copied onto a master set of floppy disks, and the day-by-day floppies can be reused. It's a good idea to have at least two sets of master disks in use as backups, and to alternate between them (ie. backup onto one set one week, and onto the other the next). This way, if you have a power cut or accident whilst you are actually making the backup, and both the hard disk and the floppy are ruined, you can always go back to your last backup. This wouldn't be possible if you had just used one set, as you would have just lost your last backup by copying over it!

Making the Backups

You are supplied with commands to help you make backups: in particular the BACKUP and RESTORE commands.

It is best to become familiar with the general use and operation of MS-DOS commands by studying Section 7: 'Using MS-DOS to organise your Disks'. The reference sections for BACKUP and RESTORE are contained in the next section of this Chapter (4.2.2). A typical command for backing-up is

BACKUP C: A: /S/M

which would backup all the files (including those in subdirectories) which have changed since the last backup.

4.2.2 Command Reference

BACKUP

External command

BACKUP [d:] [\][path\][filename.filetype] [d:] [option[option...]]

Backup files from one disk to another

An important precaution against damaged disks is to keep security or 'backup' copies on a different disk of as many of your 'working' files as possible. The BACKUP command helps you make such copies - either on a different floppy disk or on the hard disk. It can also help you make copies on floppy disks of files stored on the hard disk. The files can later be transferred back onto a 'working' disk with a RESTORE command.

The options control:

- whether existing backup files on the disk are overwritten by the new copies
- if backups are made of files that haven't been changed since they were last backed-up
- if backups are made of files created before a certain date
- the keeping of a record of the backup process

An exit code is set by BACKUP to record whether the backup was completed successfully. This can be used in an IF command to determine the next command.

Form BACKUP [d:] [\][path\][filename.filetype][d:] [option[option...]]

Options /S	Backup subdirectories as well.
/M	Only backup files that have the Archive attribute set. This generally means that the file has been changed since it was last backed-up.
/A	Add these files to the backup files already on the disk: don't overwrite the current files.
/D: dd-mm-yy	Backup only those files that were last changed on or after the given date

Note You won't be able to restore these files through the PC-DOS version of the RESTORE command.

/L[filename.filetype] Keep a log of the files that are backed-up by this command line. If you don't give a filename.filetype for the log file, then it will be stored in the file BACKUP.LOG in the root directory of the backup disk. The new information is appended to any log that is already stored in this file.

Exit codes	0	Normal completion.
	1	No files found to backup.
	2	Some files not backed-up because of sharing conflicts (networked systems only).
	3	Terminated by user.
	4	Terminated due to error.

Notes You won't be able to backup using a drive that has been ASSIGNED, JOINED or SUBSTITUTED.

BACKUP displays the name of each file as it is backed-up.

You should label each of your backup disks and number them consecutively. This will help you when you come to restore any of the files.

The Log records the date and time of the backup, the name of each file and the number of the disk the backup copy is stored on.

Examples

To backup all the files in the current directory on Drive C onto the disk in Drive A, overwriting any files that are already there, use the command line:

BACKUP C: A:

(assuming that the external command **BACKUP** is stored in the default directory or in a directory that MS-DOS automatically searches)

The backup copies are all stored in the Root directory on Drive A.

To backup all the files in the \DIR1 directory on Drive C (a subdirectory of the Root directory) onto the disk in Drive A, adding to the files already in the Root directory on Drive A, use the command line:

BACKUP C:\DIR1 A:/A

To backup all the files on the hard disk – Drive C (ie. not just the files in the Root directory but those in all the subdirectories as well) onto the disk in Drive A, use the command line:

BACKUP C: A:/S

These files are all stored in the Root directory on Drive A.

To keep a record of which files are backed-up on the backup disk and the date the copies were made, you should use the /L option in your command line. For example, to record that you backed-up the files in the current directory on Drive C onto the disk in Drive A, you might use the command line:

BACKUP C: A:/L

The record would then be kept on the backup disk in a file called **BACKUP.LOG**. If, however, you wanted to give this file a special name – for example, **RECORDS.LOG** – you should change the command line to:

BACKUP C: A:/LRECORDS.LOG

RESTORE

External command

RESTORE *d: [d:]\[\][path\][filename.filetype][option[option...]]*

Restore backed-up files

The RESTORE command copies files from backup disks onto working disks (eg. your hard disk), usually replacing the existing versions of the same file on your working disk.

The options control:

- if only files that have been changed since they were last backed-up are restored
- if only files that have been changed since a particular date are restored
- if only files that have been deleted from the working disk (ie. files of which there is no existing version on this disk) are restored
- if hidden and Read-Only files are only restored with your knowledge

At the end of the process, RESTORE sets an exit code to record how it finished. This can be used in an IF command.

Form **RESTORE** *d: [d:]\[\][path\][filename.filetype][option[option...]]*



Options	/S	Restore subdirectories as well
	/P	Prompt for permission before restoring any hidden or Read-Only files
	/M	Only restore files that have been changed since they were last backed-up
	/A: dd-mm-yy	Only restore files that were last changed on or after the given date
	/B: dd-mm-yy	Only restore files that were last changed on or before the given date
	/N	Only restore files that no longer exist on the working disk

Exit codes	0	Normal completion
	1	No files found to restore
	2	Some files not restored because of sharing conflicts (networked systems only)
	3	Terminated by user
	4	Terminated due to error

Note If you want to restore files that were backed-up using an earlier version of MS-DOS, use the /P option. Then you will be able to prevent the system files of the current version of MS-DOS being overwritten by the system files of the earlier version. Type N when MS-DOS asks you to confirm that you want either the IO.SYS file or the MSDOS.SYS file restored.

Examples

To restore all the files matching the filename template *MY*.TXT* to the *\DIR1* directory (a subdirectory of the Root directory) on your hard disk (the default drive) from the backup disk in Drive A, use the command line:

```
RESTORE A: \DIR1\MY*.TXT
```

(this assumes that the external command *RESTORE* is either in the default directory or in a directory on the search path).

If you want to restore only those files which no longer exist on your working disk, make your command line:

```
RESTORE A: \DIR1\MY*.TXT/N
```

To restore all the files from the backup disk in Drive A onto your hard disk (the default drive), and to restore the structure of directories as well, use the command line:

```
RESTORE A: *.* /S
```

This will replace every file on your hard disk – including hidden files and files that you have marked Read-Only. If you don't necessarily want these files to be replaced – in particular, if you don't want the *IO.SYS* and *MSDOS.SYS* hidden files to be replaced – you should use the */P* option. Your command line then becomes:

```
RESTORE A: *.* /S /P
```

Then, before a hidden file or a Read-Only file is replaced, you will see a message like:

```
Restore filename.filetype (Y/N)?
```

Type **N** if you don't want this file replaced.

4.2.3 Hard Disk Operating Systems

This section is for specialist use only and describes how the Operating System is installed on the hard disk and what considerations apply when changing the installed operating system.

The DOS Partition and Block Sizes

Use of the command *FDISK* to partition the hard disk was covered in Section 3. Normally, the whole disk will be used for a DOS partition. Once the partition has been set up, the *FORMAT* command can be used to place the (blank) directory structure onto the disk, and check that the whole of the disk surface is usable.

Because there is a fundamental difference between the way in which DOS 2 and DOS 3 handle large disks, it is VERY IMPORTANT to ensure that the disk is prepared using the actual FDISK and FORMAT supplied with the appropriate DOS you are about to install. It is not good enough, for example, to 'inherit' the partitions set up by a different version of FDISK. DOS uses the directory to divide the disk into blocks; each file being made up of a whole number of blocks. DOS 2 installs 4 Kbyte blocks on a 10 Mbyte disk and 8 Kbyte blocks on a 20 Mbyte disk. DOS 3 also uses 4 Kbyte blocks on a 10 Mbyte disk, but reverts to the smaller 2 Kbyte block on 20 Mbyte disks. DOS 3 is therefore much more efficient in its use of space on a 20 Mbyte disk.

The MS-DOS files

MS-DOS itself is contained in the two files IO.SYS and MSDOS.SYS which are hidden files. They can be observed by using the CHKDSK command. The bootstrap program installed on the hard disk by FORMAT must find IO.SYS as both the first file in the directory and the first file on the disk. MSDOS.SYS, however, can be anywhere on the disk (in the root directory). The third file COMMAND.COM is almost always required also, as it contains all the instructions to accept and carry out MS-DOS commands. COMMAND.COM is normally contained in the root directory but can be relocated if a suitable SET COMSPEC=<pathname> is contained in the file CONFIG.SYS.

Note: All three files must be from the same version of MS-DOS.

The equivalent filenames in PC-DOS are IBMBIO.COM, IBMDOS.COM and COMMAND.COM.

The FORMAT /S command will automatically install the bootstrap program and the MS-DOS files correctly. The three files will be installed consecutively. At a later stage the SYS command can be used to update the system on the hard disk. The SYS command will fail if the replacement IO.SYS plus (if consecutive) MSDOS.SYS.

The AMSTRAD 3.2 version of SYS is unique in its capability of installing MS-DOS onto a disk which currently contains PC-DOS (overwriting files with the PC-DOS names rather than the MS-DOS names).

BEWARE: Remember the previous warning about mixing versions of FDISK, FORMAT and DOS on a hard disk.

4.2.4 Transporting the PC HD

Whenever you wish to move your AMSTRAD hard disk PC, take the following precautions:

- **Always park the heads first (see the section below entitled 'Parking the heads').**
- **Do not move the unit from a cold environment (eg. the boot of a car) into a warm environment and attempt to use it immediately – wait until the unit has reached room temperature.**
- **Take special care when transporting and handling the system unit (which contains the hard disk drive) – it is very sensitive to vibration and will almost certainly be damaged if you drop it.**

Parking the heads

Prior to moving your AMSTRAD PC HD, whether across the office or across town, it is necessary to park the hard disk mechanism's read/write heads. To perform this operation, run the PARK.COM utility as now described. (The PARK.COM utility is provided on Disk 4 and will have been copied to the hard disk during the installation process in Chapter 3.)

At the C> prompt type

PARK

After a few moments, you will see the message

The heads are parked

You may now switch off or press **Esc** to return to DOS.

You should switch off the PC within ten seconds of seeing this message unless you wish to continue using the hard disk, in which case you should press **Esc** and you will see the message

ESCAPE : Returning to DOS

If you receive any messages other than those shown above, consult Appendix VII of this guide.

5. WHAT YOU CAN USE YOUR AMSTRAD PC FOR

In buying an AMSTRAD PC, you have acquired a powerful 16-bit microcomputer. You probably already have a rough idea what you are going to use it for, but now is the time to look at what your PC can do in a little more detail. It might be that it can do more than you originally thought.

If you plan to use your AMSTRAD PC at the office, you might use it to:

- prepare letters and reports
- keep accounts and prepare invoices
- keep all the information you need to refer to available at your fingertips
- generally help you to carry out routine tasks

If you plan to use your AMSTRAD PC at home, you might use it to:

- prepare letters
- keep your address book and phone list up to date
- computerise your home accounts; help you budget ahead
- write and develop your own programs
- play computer games

The AMSTRAD PC is supplied to you with 'system' programs, that is the 'tools' needed to use your computer. What you use your AMSTRAD PC for will depend on the 'application' programs you buy from your computer dealer or write for your machine.

- If you want to prepare reports and letters, you might buy a word processing package
- To help with your accounts, you might buy a spreadsheet or a specialised accounting program - for example a sales ledger
- To ensure that the information you need is also available 'at your fingertips', you might buy a database program
- To keep your address book and phone list up to date, you might write your own program - either with the help of the Locomotive BASIC 2 programming system supplied with your AMSTRAD PC, or by using some other programming language you buy

An extremely wide range of programs can be run on the AMSTRAD PC, giving you a good choice not only of types of program to run but also of which program of its kind to use - which word processing package, which spreadsheet, which database, which programming language etc. etc.

You don't even have to buy programs specifically described as being for use on the AMSTRAD PC. The AMSTRAD PC's compatibility with the IBM PC and PC compatibles means you can use programs written for these machines and running either the MS-DOS or PC-DOS operating system.

Nor do you need to buy programs especially to use them on your AMSTRAD PC. If you have an IBM PC or a PC compatible at the office, you might well be able to just put one of your IBM PC disks straight into your AMSTRAD PC and use it exactly as

if it were the office PC (provided you are not breaking any copyright or licence agreements in doing so).

As the GEM software is available on the AMSTRAD PC, you may well want to choose programs that work with the GEM software and so allow you to manipulate the features of the program directly on the screen. However, a word of warning if you have a single-drive PC: trying to run GEM-based programs that were intended for computers with two floppy disk drives can lead to problems, although in general your PC can cope. Ask your dealer how well the program runs on a single-drive machine.

What you need to check is that the programs you use are:

- **written to run under the PC-DOS, MS-DOS or CP/M-86 operating system**
- **written for an IBM PC or a PC compatible with a colour Display and**
- **supplied on 5¼ inch double-sided, double-density, 48 tpi floppy disks**

The vast majority of these programs will run perfectly first time on the AMSTRAD PC. Other programs may run but won't always produce the results you expect. They may not control the screen properly or they may not respond correctly to the keyboard.

Such programs will need to be 'installed' on your AMSTRAD PC. Installing a program is not a difficult job in most cases but newcomers to computing are advised to choose programs that don't need installing if possible. Your computer dealer will be able to advise you on this. If you do need to install a program, there is advice on how to go about this in Appendix I. This Appendix also describes how to prepare disks holding only the programs you need while you are using a particular application program, for example your word processor or your spreadsheet.

The rest of this chapter is given over to describing how to get started using your AMSTRAD PC in five common ways:

- **using Locomotive BASIC 2**
- **using GEM Paint**
- **running a program that works with the GEM software**
- **running a popular DOS program**, both from the GEM Desktop and by using a DOS command line (as described in Part III of this manual)
- **using a program on a disk set up to just load and run – a 'Turnkey' program**

Note: For all programs other than Turnkey programs, you need to have loaded either the GEM software or a DOS operating system before you can start using the program. Turnkey programs are set up so that this software is loaded automatically.

IMPORTANT: WORK IF POSSIBLE WITH COPIES OF DISCS RATHER THAN WITH THE ORIGINALS. KEEP THE ORIGINALS SAFELY STORED AWAY AS YOUR MASTER COPIES FOR USE IN CASE OF ACCIDENT TO MAKE FURTHER COPIES FOR YOU TO USE.

5.1 Starting to use Locomotive BASIC 2

Locomotive Software's BASIC 2 is the programming language supplied with your AMSTRAD PC for when you want to write and then run your own programs. It works with the GEM software to enable you to make use of the mouse, the window facilities and menus while you are developing your programs.

The facilities of BASIC 2 are introduced in Part IV of this manual. What is described here is how to read the BASIC 2 software into your PC's memory so that you can start programming. This section also describes how, when you have written your BASIC 2 program, you can read BASIC 2 into your PC's memory and run your program all in one go – rather than having to go through two steps before you can run your program.

Note: Because BASIC 2 works with the GEM software, you use the GEM Desktop to tell your PC to read this software into its memory.

Reading BASIC 2 into your PC's memory

- 1 **Display the GEM Desktop, with one of the directory windows showing the root directory of Drive A (A:) or if you have a Hard Disk C:**

If you are not sure how to do this, either reset your PC (see Section 8.3) or go through the Startup procedure described in Section 8.1, in both cases using Disk 2 as your Startup disk.

- 2 **Place the Desktop disk in Drive A (the lefthand drive if you have two) and then press**

You won't need to do this if you have just switched on or reset your machine. (Or if you have a Hard Disk PC).

- 3 **Move the pointer to the BASIC2 folder and double-click the lefthand mouse button.**

The contents of the BASIC2 folder should now be displayed in this window (see below). If the folder is merely highlighted, you didn't double-click at the right speed. Try double-clicking the mouse button again – perhaps varying the speed at which you click – until you see the following display:

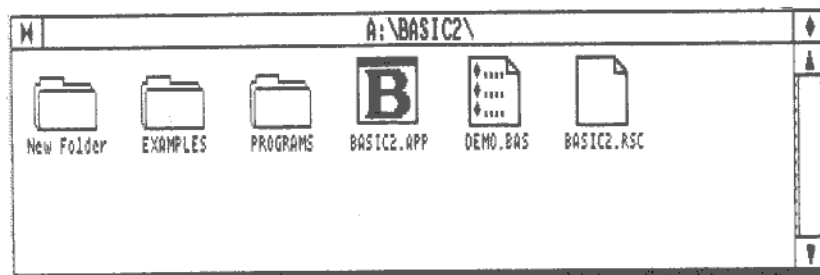



BASIC2.APP

4 Move the pointer to the BASIC2 program icon and double-click the lefthand mouse button.

The pointer should be replaced by an hour glass and the BASIC 2 software read into the PC's memory. If the icon merely becomes highlighted, try double-clicking the mouse button again – perhaps varying the speed at which you click.

Once the software has been read into your PC's memory, the screen should show something like this:

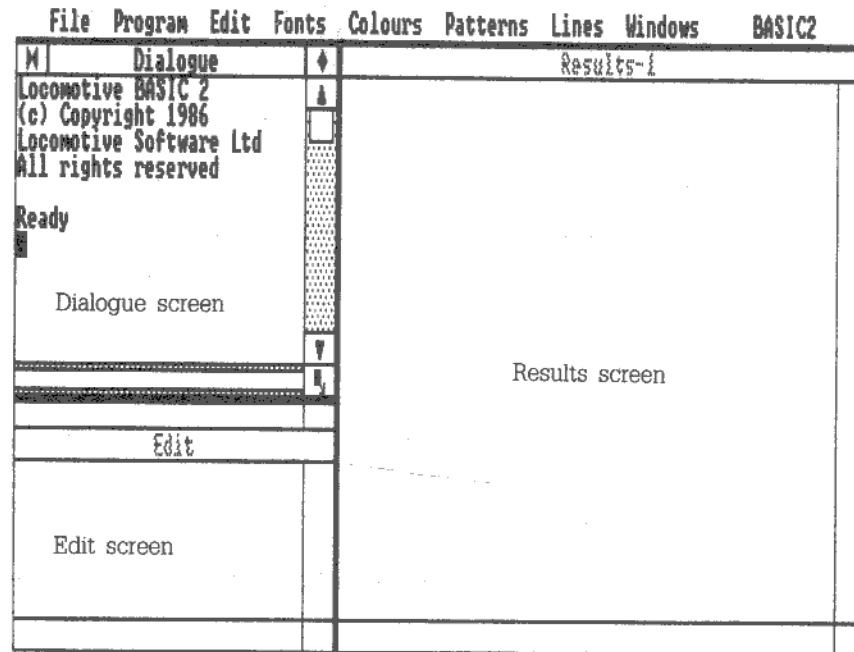

Now turn to Part IV 'Introduction to Locomotive BASIC 2' for information on how to use this special BASIC. A more extensive introduction to BASIC 2 – covering all the facilities of Locomotive BASIC 2, and explaining how to write programs incorporating these features – is given in the 'Locomotive BASIC 2 User Guide' (published by AMSTRAD), while a full Technical Reference on BASIC 2 is available from Locomotive Software.

Note: To leave BASIC 2, move the pointer to the word 'File' on the top line of the BASIC 2 screen and select the 'Quit' option from the menu that appears (by moving the pointer to 'Quit' and clicking the lefthand mouse button once).

Running your BASIC program directly from the Desktop

These instructions tell you how to read the BASIC 2 software into your PC's memory and then run your own program all in one go.

- 1 **Display the GEM Desktop, with one of the directory windows showing the root directory of Drive A (A:\) or if you have a hard disk Drive (C:\).**

If you are not sure how to do this, either reset your PC (see Section 8.3) or go through the Startup procedure described in Section 8.1

- 2 **If you have a floppy disk PC ensure that the Desktop disk is in Drive A (the lefthand drive if you have two) and then press **[Esc]****

You won't need to do this if you have a hard disk PC or have just switched on or reset your machine.



- 3 **Move the pointer to the BASIC2 folder and double-click the lefthand mouse button.**

The contents of the BASIC2 folder should now be displayed in this window (see below). If the folder is merely highlighted, you didn't double-click at the right speed. Try double-clicking the mouse button again – perhaps varying the speed at which you click – until you see the following display:

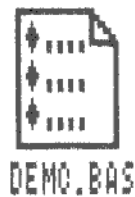
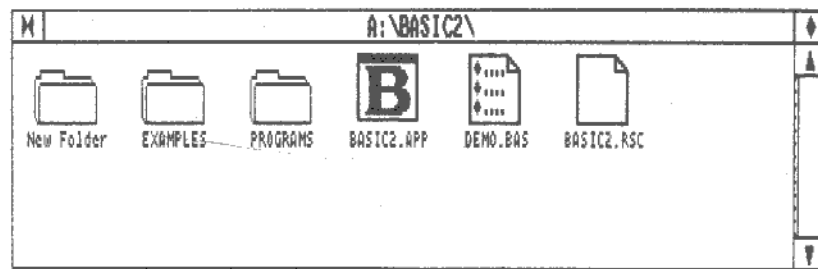

- 4 **Move the pointer to the icon that represents the BASIC program you want to run and double-click the lefthand mouse button.**

The pointer should be replaced by an hour glass and the BASIC 2 software should now be read into the PC's memory, followed by your program. If the icon merely becomes highlighted, try double-clicking the mouse button again – perhaps varying the speed at which you click.

Once the software has been read into your PC's memory, the screen should show that your program is running.

Part IV of this manual tells you in broad outline how to use a BASIC 2 program. The 'Locomotive BASIC 2 User Guide' (published by AMSTRAD) or the Locomotive BASIC 2 Technical Reference (available from Locomotive Software) will provide any further help you need in running or improving this program.

Note: To leave BASIC 2, move the pointer to the word 'File' on the top line of the BASIC 2 screen and select the 'Quit' option from the menu that appears (by moving the pointer to 'Quit' and clicking the lefthand mouse button once).

5.2 Starting to use GEM Paint

What you do with Digital Research's GEM Paint is 'paint' electronic pictures on your computer's screen - pictures that you can save, print out, display on the screen, change... etc.

Starting a new picture

- 1 Display the GEM Desktop, with one of the directory windows showing the root directory of Drive A (A:\) or C (C:\) if you have a Hard Disk by clicking on the appropriate icon.

If you are not sure how to do this, either reset your PC (see section 8.3) or go through the Startup procedure described in Section 8.1.



GEMAPPS

- 2 If you have a floppy disk PC ensure that your GEM Paint disk (disk 4) is in Drive A (the lefthand drive if you have two) and then press **[Esc]**. If you have a Hard Disk you will not need to do this as GEM Paint is already there.
- 3 Move the pointer to the GEMAPPS folder and double-click the lefthand mouse button.

The contents of the GEMAPPS folder should now be displayed in this window (see below). If the folder is merely highlighted, you didn't double-click at the right speed. Try double-clicking the mouse button again - perhaps varying the speed at which you click - until you see the following display:

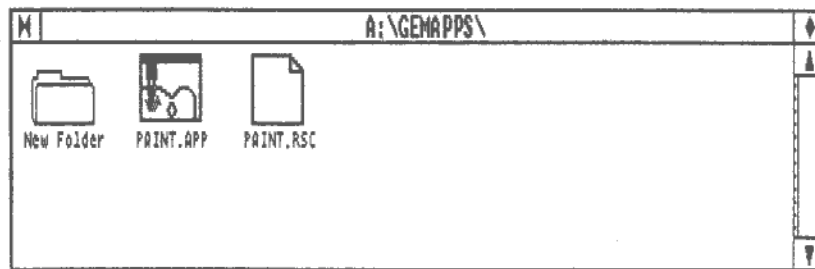

PAINT.APP

- 4 Move the pointer to the PAINT.APP program icon and double-click the lefthand mouse button.

The pointer should be replaced by an hour glass and the GEM Paint software read into the PC's memory. If the icon merely becomes highlighted, try double-clicking the mouse button again - perhaps varying the speed at which you click.

Once the software has been read into your PC's memory, the screen should show something like this:

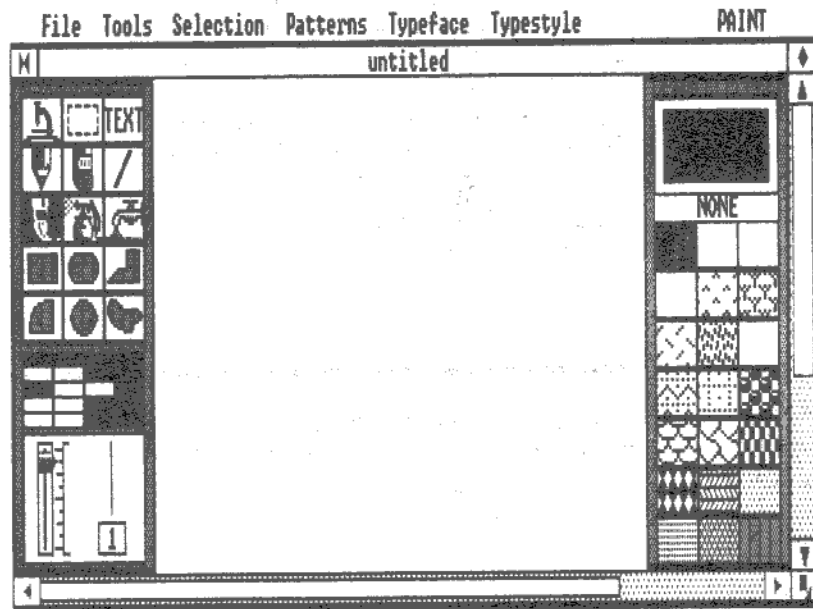

Now turn to Appendix VIII for information on how to use the GEM Paint program itself.

Note: To leave GEM Paint, move the pointer to the word 'File' on the top line of the Paint screen and select the 'Quit' option from the menu that appears (by moving the pointer to 'Quit' and clicking the lefthand mouse button once).

Changing an existing picture

- 1 Display the GEM Desktop, with one of the directory windows showing the root directory of Drive A (A:) or C (C:) if you have a Hard Disk, by clicking on the appropriate Icon.**

If you are not sure how to do this, either reset your PC (see section 8.3) or go through the Startup procedure described in Section 8.1.

- 2 If you have a floppy disk PC place your GEM Paint disk in Drive A (the lefthand drive if you have two) and then press **[Esc]**. You will not need to do this if you have a Hard Disk PC as GEM Paint is already on there.**

3 Move the pointer to the IMAGES folder and double-click the lefthand mouse button.

The contents of the IMAGES folder should now be displayed in this window (see below). If the folder is merely highlighted, you didn't double-click at the right speed. Try double-clicking the mouse button again - perhaps varying the speed at which you click - until you see the following display:

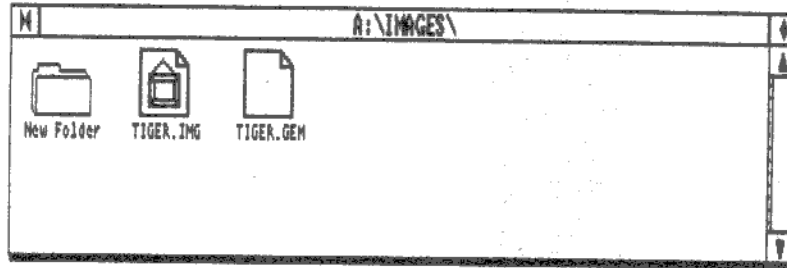

TIGER.IMG

4 Move the pointer to the icon that represents the picture you want to change and double-click the lefthand mouse button.

The pointer should be replaced by an hour glass and GEM Paint should now be read into the PC's memory, followed by the picture. If the icon merely becomes highlighted, try double-clicking the mouse button again - perhaps varying the speed at which you click.

Once the picture has been read into your PC's memory, the screen could well look something like this:



Turn to Appendix VIII for further help on using GEM Paint.

Note: To leave GEM Paint move the pointer to the word 'File' on the top line of the GEM Paint screen and select the 'Quit' option from the menu that appears (by moving the pointer to 'Quit' and clicking the lefthand mouse button once).

5.3 Running a GEM-based program

The instructions given here apply to any programs you buy for your PC that are set up to work with the GEM software, ie. to use icons and menus. As you follow these instructions, refer to the program's own user guide. This will give you more detailed instructions on what to do.

If you have a Hard Disk PC then you will want to install the new program(s) onto your Hard Disk. The program should contain its own instructions for this. It may also be run in the floppy disk drive. The GEM startup file on your Hard Disk system is called **GEM.BAT** and differs from the batch files used on a Dual Disk drive PC.

The disks you have just bought are both valuable and vulnerable to accidents. So the first thing to do is to make copies of these disks. The instructions are given in Section 6.1. Then store away the original disks for use only to make new copies from in case of accidents.

Note: Some programs are copy protected – you can't copy these by this method. However, you may be able to copy all but a part of this software – if so, how to do this will be described in the program's user guide.

Find out from the program's user guide whether the program generates any data files. Spreadsheet programs, for example, certainly do. If it does, you may need to prepare (ie. format) a new blank disk specially to hold these data files. (Details of how to format a disk are given in Section 6.2). Alternatively, you may have enough free space on one of your other disks to store the new program's data files there.

Next, discover from the program's user guide:

- the full name of the program you want to run
- which disk it is stored on (if the software is stored on more than one disk)
- which directory or folder it is stored in.

The program will have a two-part name, the parts being separated by a full stop. The second section of the name will be APP if the program works with the GEM software. If the user guide doesn't say which directory or folder the program file is in, assume it is in the main or 'root' directory of the disk.

Note: Make sure you know what each of the disks supplied with your program is called. You could, for example, find that there's a disk called Startup Disk which you are meant to use whenever the user guide mentions the Startup Disk. If you hadn't checked, you might try using one of your AMSTRAD PC Startup disks and wonder what you had done wrong! (Alternatively, the guide might talk about a System Disk, meaning the disk with the DOS system files on it – ie. your Startup disk.)

If you are already using your AMSTRAD PC, return to the Desktop, if necessary by resetting your machine (see Section 8.3). If you aren't using your PC already, switch on and load the GEM software by following the Startup procedure given in Section 8.1.

Place the disk holding the program in Drive A (your lefthand drive if you have two) and press the **Esc** key. Turn (in the program's user guide) to the section on starting the program. If your PC has two floppy disk drives, see which disk the guide suggests you put in Drive B and insert that disk.

Find the program's icon in one of the directory windows on the screen. If the program is not in the 'root' directory of Drive A, the user guide should describe how to bring the right folder onto the screen. (See Part II, Chapter 2 for details of how to 'open folders' and 'close windows'.)

Move the pointer to the program's icon and 'double-click' the lefthand mouse button.

Turn to the program's user guide for all further information on running the program.

Notes: (i) While the program is running, you can swap the program disk in Drive A for the disk holding the data you want to process. If a message later appears telling you that the file you want to use can't be found, insert your program disk and press **Esc**. If you are asked for COMMAND.COM, insert the GEM Desktop disk.

(ii) The way the AMSTRAD PC is prepared prior to running GEM software may not suit all GEM programs. You may need to change the Batch files GEM.BAT and GEM3.BAT. The program's own user guide should give guidance on what is required. If in doubt, consult your dealer.

(iii) Some user guides describe, for example, typing in the date before you really start working on the program. Beware: the descriptions they give may not be based on MS-DOS 3.2 but on, for example, PC-DOS 2.0. Be sure to check in this manual for details of how you should enter the information. For example, the user guide may well tell you to type the date as *mm-dd-yy* (*month-day-year*) when in fact you should type it as *dd-mm-yy* (*day-month-year*).

To return to the Desktop, either

- use the program's own 'Quit', 'Exit' or equivalent command, or
- click on the program window's Close box (if it has one)

5.4 Running a popular DOS program

The instructions given in this section will help you run any of the major programs used on the IBM PC - programs whose names often appear in magazines for the business computer user. As you follow these instructions, refer to the program's own user guide. This will give you more detailed instructions on what to do.

With most programs, you can choose whether to run the program from the GEM Desktop or from a DOS command line (as described in Part III of this manual).

The DOS program should contain its own instructions for installation onto your Hard Disk. Some programs that incorporate sophisticated copy-protection may not be (easily) transferable to hard disk. DOS programs may also be run in the floppy disk drive on your Hard Disk PC.

The disks you have just bought are both valuable and vulnerable to accidents. So the first thing to do is to make copies of these disks. The instructions are given in Section 6.1 (using the GEM Desktop) and Section 7.1 (using an MS-DOS command line). Then store away the original disks for use only to make new copies from in case of accidents.

Note: Some programs are copy protected – you can't copy these by this method. However, you may be able to copy all but a part of this software – if so, how to do this will be described in the program's user guide.

Find out from the program's user guide whether the program generates any data files. Spreadsheet programs, for example, certainly do. If it does, you may need to prepare (ie. format) a new blank disk specially to hold these data files. (Details of how to format a disk are given in Section 6.2 (using the GEM Desktop) and Section 7.2 (using an MS-DOS command Line).) Alternatively, you may have enough free space on one of your other disks to store the new program's data files there.

Next, discover from the program's user guide:

- the full name of the program you want to run
- which disk it is stored on (if the software is stored on more than one disk)
- which directory or folder it is stored in.

The program will have a two-part name, the parts being separated by a full stop. The second section of the name will be either BAT, COM or EXE. If the user guide doesn't say which directory or folder the program file is in, assume it is in the main or 'root' directory of the disk.

Before you go any further, check whether the program makes use of any of the DOS external commands or 'utilities'. If it does, discover from the user guide which drive it expects to find these on because you will need to put the disk holding the commands in this drive.

Notes: (i) MS-DOS commands are on Disk 1 'MS-DOS Startup and Utilities'; unless the user guide has been written specifically for the AMSTRAD PC, it will probably tell you to look for these commands on the wrong PC disk.

(ii) The program's user guide may refer to commands or utilities that have the same *filename* as a command on Disk 1 but have a different *filetype*. In particular, it may give the filetype COM when the command on Disk 1 has the filetype EXE. The files on Disk 1 are the ones you need. If you copy any of these files, make sure you give the copy the filename and filetype used on Disk 1.

(iii) Make sure you know what each of the disks supplied with your program is called. You could, for example, find that there's a disk called Startup Disk which you are meant to use whenever the user guide mentions the Startup Disk. If you hadn't checked, you might try using your AMSTRAD PC Startup disk and wonder what you had done wrong! (Alternatively, the guide might talk about a System Disk, meaning the disk with the DOS system files on it – ie. your Startup disk.)

Running the program from the GEM Desktop

Note: The process of running a DOS program from the GEM Desktop can be made more powerful if the DOS program is 'configured' for running from the Desktop. Some of the most popular DOS programs will be already configured. Configuring a program isn't essential but if you want to take advantage of this in running more of your DOS programs, you can find out how to do this from Part II, Section 3.2.

If you are already using your PC, return to the Desktop, if necessary by resetting your machine (see Section 8.3). If you are not already using your PC, switch on and load the GEM software by following the Startup procedure given in Section 8.1.

Place the disk holding the program in Drive A (your lefthand drive if you have two). Turn (in the program's user guide) to the section on starting the program. If your PC has two floppy disk drives, see which disk the guide suggests you put in Drive B and insert that disk. Press the **Esc** key.

Find the program's icon. If the program is not in the 'root' directory, the user guide should give details of the path to the directory that holds the program. Look in the root directory for the folder with the name given between the first pair of backslashes (\) in this path, and then open this folder by double-clicking on its icon. If there are more than just two backslashes in the path, look for the folder with the next name and open this in the same way and so on until you have opened all the folders in the path. (You can check that you have done this right by comparing the path given in the title line of the window with the path given in the user guide.) (See Part II, Chapter 2 for details of how to 'open folders' and 'close windows'.)

Move the pointer to the program's icon and 'double-click' the lefthand mouse button. Many programs will now run. With some programs and all unconfigured programs, your PC will need further information before it can run the program so it displays a message called a Dialog box on the screen asking for the program's 'parameters'.

The 'parameters' you need to type in should be taken from the instruction known as the 'Command line' which is needed to run the program. This will be given in the program's user guide. Type everything after the first blank space in the command line. For example, if your program's name is SPREAD and the user guide tells you to type **SPREAD INPUT.DAT YOUR.DAT**, type:

INPUT.DAT YOUR.DAT

However, if the user guide says that you would normally just type SPREAD (ie. the name of the program) in order to run it, don't type anything.

Note: Don't worry if the program's user guide assumes that you have two floppy disk drives (Drive A and Drive B) when in fact you only have one. Just type what the guide says to type for a two-drive machine. DOS will simply ask you to insert the disk for Drive B or the disk for Drive A as and when it needs these.

Press the **←** key. The program should then run (provided you have typed the parameters correctly).

Turn to the program's user guide for all further information on running the program.

Note: Some user guides describe, for example, typing in the date before you really start working on the program. Beware: the descriptions they give may not be based on MS-DOS 3.2 but on, for example, PC-DOS 2.0. Be sure to check in this manual for details of how you should enter the information. For example, the user guide may well tell you to type the date as *mm-dd-yy* (*month-day-year*) when in fact you should type it as *dd-mm-yy* (*day-month-year*).

Returning to the Desktop

When the program you have run from the GEM Desktop finishes or you leave it in its prescribed manner, your PC will attempt to return you to using the GEM Desktop. (In the case of the Hard Disk PC this will happen automatically with no user intervention or floppy disks required).

For a Single or Dual Drive PC the details are as follows:

If your program hasn't been configured to take your PC's full memory, you may see a Dialog box on the screen asking you to insert your Desktop disk. Place this disk (Disk 3) in Drive A (the lefthand drive if you have two), turn the drive handle across the drive slot to hold the disc in the drive and then press . You will then be returned to the Desktop.

If your program was configured to take the PC's full memory, a message similar to the following will be displayed:

Insert your GEM Startup Disk
Press any key to continue

Place your GEM Startup disk (Disk 2) in Drive A and then press any character key or the key. After a while, you will see a Dialog box asking you to put your Desktop disc in Drive A.

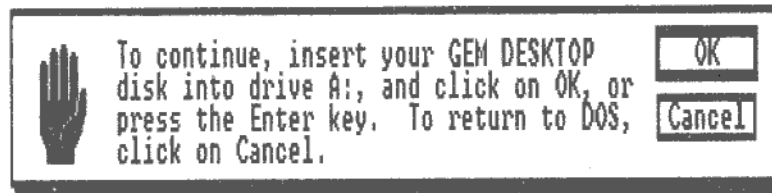

To return to the Desktop, place this disk (your AMSTRAD PC Disk 3) in Drive A and then press .

This puts you back using the GEM Desktop.

Running the program through an MS-DOS command line

The alternative to running your program from the GEM Desktop is to run it by typing an MS-DOS command line.

Switch on and load MS-DOS, by following the Startup procedure given in Section 8.1 and using Disk 1 (MS-DOS Startup and Utilities) as the startup disk. If you are already using MS-DOS on your PC, finish what you are doing then return to an A> system prompt and type:

```
CD \ 
```

Place the disk holding the program in Drive A (your lefthand drive if you have two). Turn (in the program's user guide) to the section on starting the program. If your PC has two floppy disk drives, see what disk the guide suggests you put in Drive B and insert that disk.

Look in the program's user guide for details of the instruction known as the 'Command line' which is needed to run the program. Type in the command line the user guide gives. If no command line is given, type the filename of the file holding the program - that is the part of its name before the full stop. Then press the key. Your program should now run.

Note: Don't worry if the program's user guide assumes that you have two floppy disk drives (Drive A and Drive B) when in fact you only have one. Just type what the guide says to type for a two-drive machine. MS-DOS will simply ask you to insert the disk for Drive B or the disk for Drive A as and when it needs these.

Turn to the program's user guide for all further information on running the program.

Note: Some user guides describe, for example, typing in the date before you really start working on the program. Beware: the descriptions they give may not be based on MS-DOS 3.2 but on, for example, PC-DOS 2.0. Be sure to check in this manual for details of how you should enter the information. For example, the user guide may well tell you to type the date as *mm-dd-yy* (*month-day-year*) when in fact you should type it as *dd-mm-yy* (*day-month-year*).

5.5 Using a 'Turnkey' program

A 'Turnkey' program is one stored on a disk together with the system programs in such a way that your PC will automatically run the program immediately after it has read the operating system software into its memory.

Two ways of running such a program are described here. The first of these describes how to run the program as the first thing you do after switching on; the second describes how to run the program when you have already been working on your machine.

Note: (i) Some program user guides assume that your PC has two floppy disk drives. Don't worry if this is the case: just type in exactly what it says for two floppy disk drives called Drive A. Your PC will ask you to insert the disk for Drive A when it wants programs or data you have told it are on Drive A, and it will ask for the disk for Drive B when it wants programs or data that you have told it are on Drive B.

(ii) Make sure you know what each of the disks supplied with your program is called. You could, for example, find that there's a disk called Startup Disk which you are meant to use whenever the user guide mentions the Startup Disk. If you hadn't checked, you might try using your AMSTRAD PC Startup disk and wonder what you had done wrong! (Alternatively, the guide might talk about a System Disk, meaning the disk with the MS-DOS system files on it - ie. your Startup disk.)

(iii) If anything happens as you work through these instructions that is not explained here, turn to the 'troubleshooting' section, Appendix VII.

Switch on and run

Start with

- the mains plug out of the supply socket
- the power switch on the back of the Display in its OFF position (fully released)
- no disk in any floppy disk drive.

Work through the Startup procedure given in Section 8.1, using the program disk as the Startup disk. Follow any additional instructions either in the program's user guide or that appear through messages on the screen.

While the PC is reading software from your disk, you will see the green indicator light on the drive go on and off a few times. When it has finished, the Display will be showing the first screen display of your program.

Turn to the program's own user guide for details of how to carry on.

Running the program when the PC is already on

Put the disk holding your program into Drive A (your lefthand disk drive if you have two) and close the door lock to hold it there.

Hold down the **Ctrl** and **Alt** keys and press the **Del** key. Your PC then reads the software from this disk. You will see the green indicator light on the drive go on and off a few times while this is happening.

When it has finished, the Display will be showing the first screen display of your program. Turn to the program's own user guide for details of how to carry on.

Note: Some user guides describe, for example, typing in the date before you really start working on the program. Beware: the descriptions they give may not be based on MS-DOS 3.2 but on, for example, PC-DOS 2.0. Be sure to check in this manual for details of how you should enter the information. For example, the user guide may well tell you to type the date as *mm-dd-yy* (*month-day-year*) when in fact you should type it as *dd-mm-yy* (*day-month-year*).

6. USING GEM TO ORGANISE YOUR DISKS

This chapter gives step by step instructions on each of the tasks involved in keeping your disks and the files stored on them ready for use. The contents are as follows:

- 6.1 Copying a disk
- 6.2 Preparing a new blank disk (Formatting)
- 6.3 Copying a file
- 6.4 Deleting a file
- 6.5 Renaming a file
- 6.6 Finding out how large a file is
- 6.7 Finding out how much unused storage space there is on a disk
- 6.8 Using the Editor to create or change a text file

Note: All these actions are carried out when you have the GEM Desktop on the screen, ie. one or two windows on the screen showing either what disk drives your PC has or the folders and files in a particular directory. (It will also have the word 'DESKTOP' in the top righthand corner of the screen.)

If you are already using your AMSTRAD PC, return to the Desktop from whatever you are doing. If you are not certain how to do this, reset your machine - instructions for this are given in Section 8.3. If you have yet to switch on your AMSTRAD PC, go through the Startup procedure described in Section 8.1.

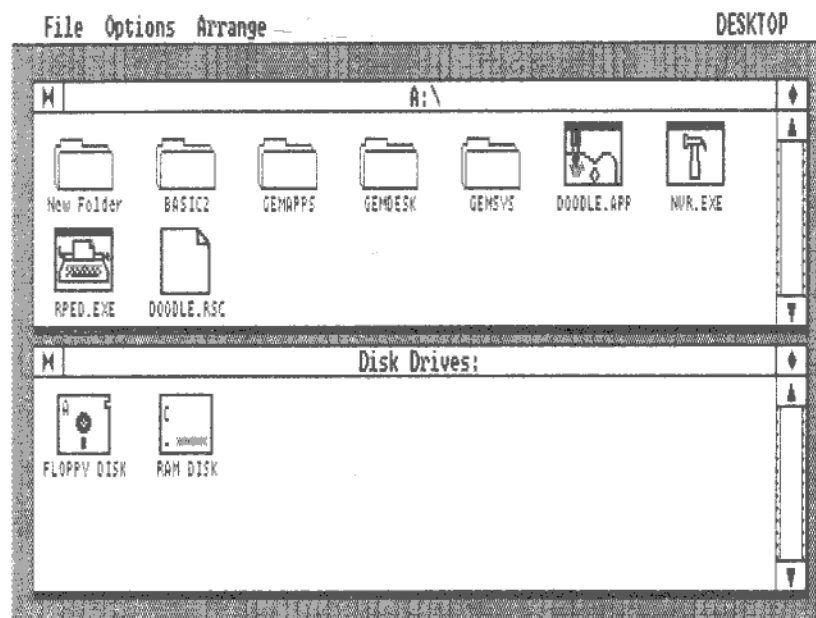

IMPORTANT: WORK IF POSSIBLE WITH COPIES OF DISKS RATHER THAN WITH THE ORIGINALS. KEEP THE ORIGINALS SAFELY STORED AWAY AS YOUR MASTER COPIES FOR USE IN CASE OF ACCIDENT TO MAKE FURTHER COPIES FOR YOU TO USE.

6.1 Copying a disk

The process of copying a disk onto a fresh disk makes the second disk a 'photocopy' of the first. Immediately after the copy has been made, the two disks are identical in every way, but subsequent processing of either disk will stop them from being identical.

Note: (i) If you want to put the copy on a new blank disk, you don't have to format the new disk before you start to make your copy.

(ii) If you copy a Startup disk, you create a disk that can also be used as a Startup disk.

The steps to copying a disk are as follows:

If you have a Floppy Disk PC insert Disk 1 in drive A (the lefthand drive). Using the Mouse move the pointer to the word 'Options' in the top line of the screen. This brings the GEM Desktop's Options Menu onto the screen. Now move the pointer to the words **Enter DOS commands**. When these words become highlighted, click the lefthand mouse button once.

Type: **DISKCOPY A: B:**

and then press the key.

What happens next depends on whether your PC has one or two floppy disk drives.

● If you have a single-drive PC

After a short while, you will see the following message on the screen:

Insert SOURCE diskette in drive A:

Press any key when ready

1 Remove the Desktop disk from the drive and insert the disk you want to copy.

Turn the drive handle anticlockwise to release the disk, then withdraw it completely from the drive and replace the disk in its paper cover. Insert the disk you want to copy in the drive and then turn the drive handle back across the drive slot.

2 Press

After a short while, you will see the message:

Copying — *n* tracks

m Sectors/track, 2 side(s)

followed by:

Insert TARGET diskette in drive B:

Press any key when ready

3 Remove the disk from the drive and insert the disk you want to store the copy on.

Turn the drive handle anticlockwise to release the disk, then withdraw it completely from the drive and replace the disk in its paper cover. Insert the disk you want to store the copy on in the drive and then turn the drive handle back across the drive slot.

4 Press

If you are storing the copy on a new blank disk or on disk that has a different format to your Source disk, you will see the message:

Formatting while copying

Finally the message:

Copy another diskette (Y/N)?

5 Type if you want to copy another disk; type to leave DISKCOPY. Type EXIT

Put your Desktop disk into Drive A, turn the drive handle across the drive slot and then press the key. You will then be returned to the GEM Desktop.

● **If you have a two-drive PC**

After a short while, you will see the following message on the screen:

Insert SOURCE diskette in drive A:
Insert TARGET diskette in drive B:
Press any key when ready

1 Remove the disks currently in the drives and insert the disk you want to copy in Drive A (your lefthand drive) and the disk you want to store the copy on in Drive B (your righthand drive).

To remove a disk, turn the drive handle anticlockwise and then withdraw the disk completely from the drive. Replace the disks in their paper covers. Insert the disk you want to copy and the disk you want to store the copy on in their appropriate drives and then turn the drive handles back across the drive slots.

2 Press

After a short while, you will see the message:

Copying - n tracks
m Sectors/track, 2 side(s)

If you are storing the copy on a new blank disk or on disk that has a different format to your Source disk, you will see the message:

Formatting while copying

Finally the message:

Copy another diskette (Y/N)?

- 3 Type **[Y]** if you want to copy another disk; type **[N]** to leave DISKCOPY. Type EXIT.

Put your Desktop disk into Drive A (your lefthand drive), turn the drive handle across the drive slot and then press the **[←]** key. You will then be returned to the GEM Desktop.

6.2 Preparing a new disk for use – Formatting

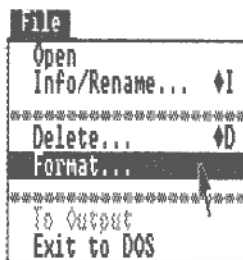

The storage area of a new disk needs to be marked out in sections electronically before you can use the disk to store any programs or data. This process is called formatting.

When you copy a disk onto a new blank disk, the new disk is automatically formatted for you as part of the copying process. You only have to remember to format the new disk when you want to have it ready to store, for example, the data files your spreadsheet program is about to produce.

The process can also be used with an old disk the data on which has become corrupted. If the disk hasn't been physically damaged, formatting the disk can reclaim all its storage space. However, before you do this, do be sure to copy as many as possible of your files to other disks before you reformat the disk. Formatting a disk wipes it clean of any stored data.

Note: The method described here is not recommended if you have a single-drive PC. Reset your PC using Disk 1 as your Startup disk and then follow the instructions in Section 7.2.

The steps you need to take are as follows:

- 1 Select which of your two directory windows to work in.
- 2 Move the pointer to this window's Close Box ('bow-tie') and click the lefthand button on the mouse. Repeat this until the window is displaying your PC's disk drives.

The window you require is entitled 'Disk Drives' and it is the furthest you can go in closing up a directory window.

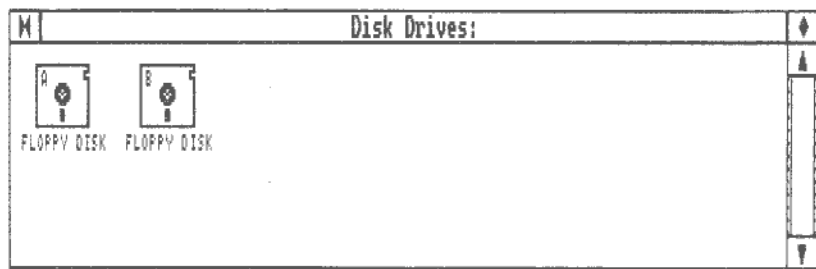

- 3 Insert the Desktop disk (Disk 3) in Drive A. Insert the disk you want to format in Drive B.
- 4 Move the pointer to the icon for Drive B. Click the lefthand button on the mouse once.

- 5 Move the pointer to the word 'File' in the menu bar at the top of the screen.

This brings the File menu onto the screen.

- 6 Move the pointer to the entry 'Format...' in the menu and then click the lefthand mouse button once.

The following Dialog box then appears on the screen, asking you to confirm that you want to format the disk.

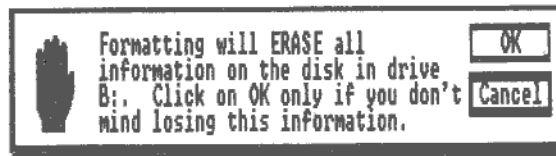

- 7 Check the details in the Dialog box and that you do have the disk you want to format in Drive B.
- 8 Move the pointer to the [OK] exit button and click the lefthand button on the mouse.

The disk is then formatted.

6.3 Copying a file

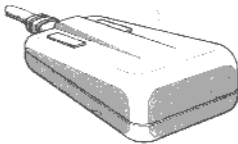

Copying a file makes a new file that contains all the same information as the original. This copy can be stored either in the same folder (or directory) as the original or in a different folder, often on a different disk.

The methods of copying described here make copies of one or more files. However, the files must be all in the same folder (or directory), so if you want to copy files from separate folders, you must repeat the process for each folder in turn.

The originals of the files are known as the 'Source' and where the copies are stored is known as the 'Destination'.

Note: The method of copying described here is not recommended for copying files from one disk to another if you have a single-drive PC. You are advised to use the DOS command COPY instead, as described in Section 7.3. Move over to using DOS by pulling down the Options menu and clicking the lefthand mouse button when the pointer is on **Enter DOS commands**. When you have finished making the copy, type **EXIT** and then press the  key to return to the Desktop.

The steps are as follows:

1 Display both the 'Source' folder and the 'Destination' folder on the screen.

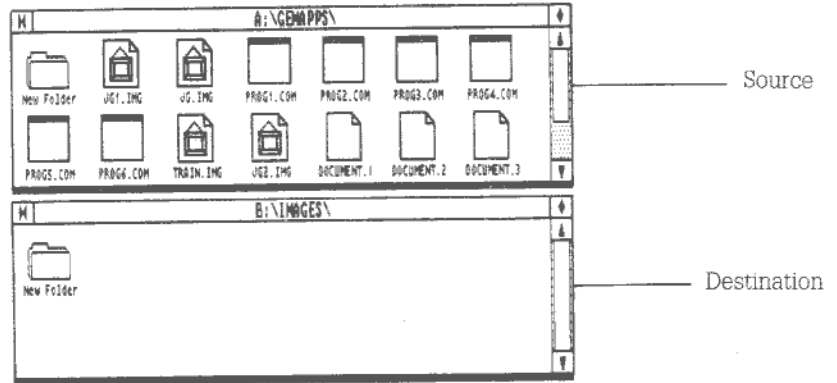

How to get the folders you want displayed on the screen is described Part II, Section 4.1.

Note: If the copies are to be stored in the same folder as the original files, you only need to display this folder once. You don't need to display it in two separate windows.

2 Select the icon or group of icons in the 'Source' folder representing the files you want to copy.

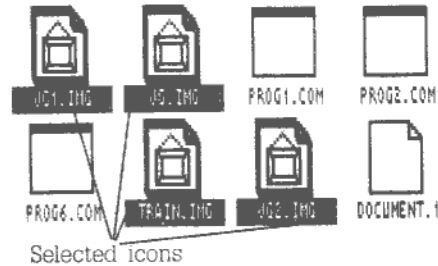

To select one icon, just move the pointer to this icon and then click the lefthand mouse button once. To select a group of icons, move the pointer to each icon in turn, hold down the righthand mouse button and then click the lefthand button before moving on to the next icon. (See Part II, Section 2.4.)

3 With the pointer over a selected icon, hold down the lefthand mouse button and then move the pointer to an empty area in the 'Destination' folder.

The pointer changes to a hand as you move it.

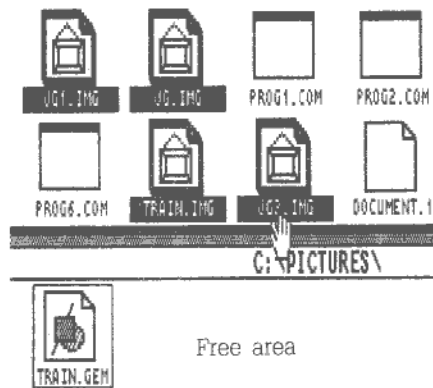

To determine what part of a directory window is 'empty', imagine a rectangle drawn around each icon and its name. The free area is anywhere still inside the window but outside these rectangles.

4 Release the mouse button.

The 'Copy folders/items' Dialog box is now displayed in the centre of the screen (unless you have specifically turned off the display of this box).

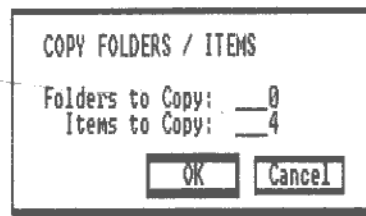

This tells you how many items GEM thinks you have asked it to copy. If there appears to have been some mistake, move the pointer to the [Cancel] exit button of the Dialog box and click the lefthand mouse button: then repeat Steps 3 - 5.

5 Move the pointer to the [OK] exit button of the Dialog box and click the lefthand mouse button.

GEM now starts copying the files one by one into the destination folder. As each file is successfully copied, the number displayed in the Dialog box is reduced by one. If no Dialog box was displayed, you will see each file and folder in turn being picked out by a fine box and 'zoomed' into the destination folder.

Each new copy is stored with the same name as the original if this is possible. If this is not what you want, you can rename the copy after it has been created.

GEM won't copy a file if it has the same name as a folder or a file already stored in the Destination folder. Instead it will display a 'Name Conflict' Dialog box. What to do is described below.

When names conflict

Name conflicts arise because a single directory cannot contain two folders or two files with the same name. So when this would be about to happen, your PC displays a Dialog box.

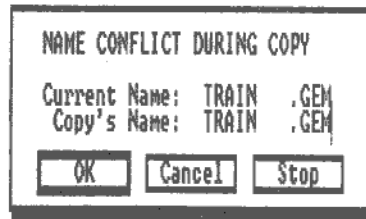

This box can either have a 'Current Name' but no 'Copy's Name' or the same name for both the 'Copy's Name' and the 'Current Name'.

If a 'Current Name' is given but no 'Copy's Name' you must type in a different name as the 'Copy's Name' before moving the pointer to the [OK] exit button and clicking the lefthand mouse button once. The copy will then be made. (Move the pointer to the [Stop] exit button if you decide against making the copy.)

If the same name appears next to both 'Copy's Name' and 'Current Name', you can:

- delete the file that is causing the conflict and replace it with your copy by moving the pointer to the [OK] exit button and clicking the lefthand mouse button once
- give the copy a different name by pressing [Esc] and typing in a new name before moving the pointer to the [OK] exit button and clicking the lefthand mouse button once
- abandon copying this file by moving the pointer to the [Cancel] exit button and clicking the lefthand mouse button once.
- abandon the copy operation altogether by moving the pointer to the [Stop] exit button and clicking the lefthand mouse button once.

6.4 Deleting a file

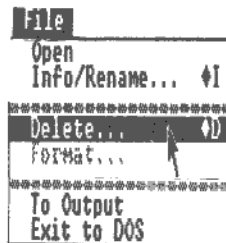

Deleting files removes the information stored in them from your disk: this information cannot be recovered. You can delete files either one at a time or in a group (provided they are all in the same folder/directory).

The steps are as follows:

1 Select the icons of the files you no longer want.

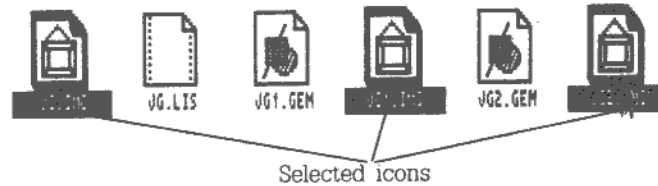

To select one icon, just move the pointer to this icon and then click the lefthand mouse button once. To select a group of icons, hold down the righthand button on the mouse and then move the pointer to each icon in turn and click the lefthand button before moving on to the next icon. (See Part II, Section 2.4.)

2 Move the pointer to the word 'File' on the top line of the screen.

This brings the File menu onto the screen.

3 Move the pointer to the 'Delete...' entry in this menu and click the lefthand mouse button once.

GEM then displays the 'Delete Folders/Items' Dialog box (unless you have turned off the display of this box).

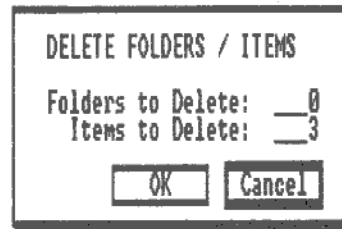

This box contains details of the number of items your PC thinks you have asked it to delete: if this appears to be wrong, press the key and repeat Steps 2 - 3.

4 Move the pointer to the [OK] exit button and click the lefthand mouse button once.

GEM now deletes the files one by one. Each time a file is deleted, the number shown in the Dialog box is reduced by one. If no Dialog box was displayed, the actual icons are removed one by one. The window is 'tidied up' again after all the files and folders have been deleted.

6.5 Renaming a file

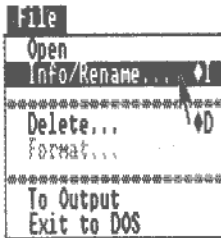

Files do not have to keep the name they were given when they were created. In most cases, you can give a file a new name any time you choose.

The new name you choose should:

- be different from any other file or folder name in this folder
- suit the needs of the programs you are going to use to process the file (refer to the programs' user guides)
- remind you of the information the file is used to store

The usual characters to use in the name are the letters A...Z and the numbers 0...9, but you can use some other characters as well (see Section 8.4).

The steps are as follows:

- 1 Move the pointer to the icon of the file you want to rename and click the lefthand mouse button once.**
- 2 Move the pointer to the word 'File' on the top line of the screen.**
This brings the File menu onto the screen.
- 3 Move the pointer to the 'Info/Rename...' entry in this menu and click the lefthand mouse button once.**

GEM then displays the 'Item Information/Rename' Dialog box, showing the current name of the file.

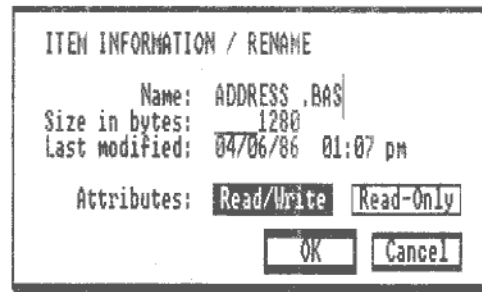

- 4 Edit the name shown in the Dialog box so that it becomes the new name.**
Press the **Esc** key (to clear the old name) and then type in the new name. (Use the **Del** key to correct any mistakes you make in typing in the new name.)
- 5 Move the pointer to the [OK] exit button in the Dialog box and click the lefthand mouse button.**
 - If the new name is acceptable, the file is given this name.
 - If the new name is already the name of a file in the same directory, your PC will display a special Dialog box. Read the message in the box, press the **Enter** key and then go through Steps 2 - 5 again if you still want to rename this file.

6.6 Finding out how large a file is

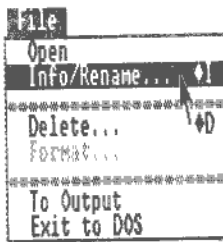

- 1 Move the pointer to the icon representing the program or document you want information on and click the lefthand button on the mouse once.
- 2 Move the pointer to the word 'File' on the top line of the screen.
The File menu then appears on the screen.
- 3 Move the pointer to the 'Info/Rename...' entry in this menu and click the lefthand mouse button once.

Your PC then puts a Dialog box on the screen containing brief details of the disk you have selected, including the amount of free space on the disk measured in bytes. (1000 bytes holds about 1000 characters.)

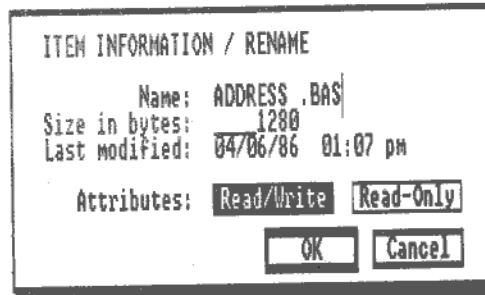

When you have finished reading the information in the Dialog box, move the pointer to the [OK] exit button and click the mouse button.

6.7 Finding out how much unused storage space there is on a disk



- 1 Decide which window to use to display your PC's Disk Drives.
- 2 Move the pointer to this window's Close Box (the box in the corner with a 'bow-tie' in it) and click the lefthand button on the mouse until the window displays your PC's Disk Drives.
Note: You cannot 'overshoot' because this particular display cannot be closed by clicking on its Close Box.
- 3 Insert the disk you want to examine in Drive A (your lefthand drive if you have two) and close the drive handle.
- 4 Move the pointer to the icon representing the disk you want information on and click the lefthand button on the mouse once.
- 5 Move the pointer to the word 'File' on the top line of the screen.

This brings the File menu onto the screen.

6 Move the pointer to the 'Info/Rename...' entry in this menu and click the lefthand mouse button once.

Your PC then puts a Dialog box on the screen containing brief details of the disk you have selected, including the amount of free space on the disk measured in bytes. (1000 bytes holds about 1000 characters.)

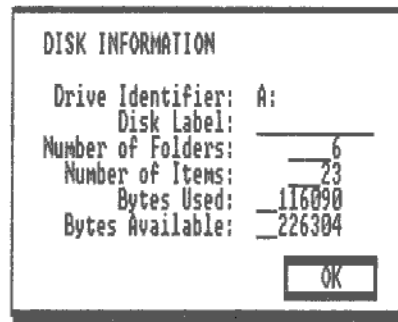

When you have finished reading the information in the Dialog box, move the pointer to the [OK] exit button and click the mouse button.

6.8 Using the Editor to create or change a text file



RPED.EXE

The AMSTRAD PC is supplied with a screen-based Text Editor called RPED, which is very useful for editing small text files. As it shows the file you are editing on the screen, it is very easy when you are using RPED to look over sections of the text file you are creating or changing, spot a mistake, move the cursor to this mistake and make your corrections.

The main use you are likely to make of RPED is for creating or updating files that have the filetype BAT, in accordance with instructions in your programs' user guides. (These guides may suggest you use the MS-DOS text editor EDLIN but you will probably find using RPED easier.) Other files are usually all created by the programs you run and updated by them as well.

The RPED program is stored on Disk 3 (GEM Desktop and BASIC 2).

Overview of using RPED

The first screen that RPED displays, tells you about the keys on your keyboard you will be able to use while you are working with RPED. It also asks you whether you want:

- to edit (ie. change) an existing file
- to immediately re-edit the file you have just finished editing
- to create a new file

and it tells you which key to press to make your selection. Put the disk holding the file you want to edit (or the disk you are going to store the new file on) in Drive A and then press the key appropriate to the job you want to do.

RPED then asks you questions about the file you want to edit. If you want to edit an existing file, RPED needs details of where this file is stored and of the file you want to store the edited version in because the new version doesn't have to replace the old version. If you want to re-edit the file you have just finished editing or you want to create a new file, RPED just asks you where the edited version is to be stored.

After you enter this information and press **[←]**, you will see either the current version of the file displayed on the screen or a blank page ready for you to type in your new file. Messages on the screen tell you which keys to press to do such actions as:

- inserting a new line
- deleting a line

Running RPED

- 1 Check you have Disk 3 (GEM Desktop and BASIC 2) in Drive A (your lefthand drive if you have two).**

You will automatically have this disk in the drive if you have just switched on or reset your PC.

If you have a Hard Disk PC RPED will be already available (just click on the Hard Disk icon).

- 2 Find the RPED.EXE program's icon.**

- 3 Move the pointer to the RPED.EXE program's icon and 'double-click' the lefthand mouse button.**

The pointer should briefly be replaced by an hour glass and then the following should be seen. This is RPED's opening screen:



RPED.EXE

This screen editor is for small files (up to 750 lines) and uses normal Cursor, Page, Home, End, Insert and Delete keys.

f1 = Edit Existing File
f2 = Re-edit Previous File
f3 = Create New File
f4 = Quit

7. USING MS-DOS TO ORGANISE YOUR DISKS

This chapter gives step by step instructions on each of the tasks involved in keeping your disks and the files stored on them ready for use. The contents are as follows:

- 7.1 Copying a disk
- 7.2 Preparing a new blank disk (Formatting)
- 7.3 Copying a file
- 7.4 Deleting a file
- 7.5 Renaming a file
- 7.6 Finding out the size of a file
- 7.7 Finding out how much unused storage space there is on a disk
- 7.8 Using the Editor to create or change a text file

IMPORTANT: WORK IF POSSIBLE WITH COPIES OF DISKS RATHER THAN WITH THE ORIGINALS. KEEP THE ORIGINALS SAFELY STORED AWAY AS YOUR MASTER COPIES FOR USE IN CASE OF ACCIDENT TO MAKE FURTHER COPIES FOR YOU TO USE.

7.1 Copying a disk

The process of copying a disk onto a fresh disk makes the second disk a 'photocopy' of the first. Immediately after the copy has been made, the two disks are identical in every way, but subsequent processing of either disk will stop them from being identical.

Note: (i) If you want to put the copy on a new blank disk, you don't have to format the new disk (as described in Section 7.2) before you start to make your copy.

(ii) If you copy a Startup disk (ie. a disk that you use immediately after switching your machine on) you create another disk that can be used as a Startup disk.

The steps to copying a disk are as follows:

1 Display an A> system prompt (or C> if you have a hard disk PC).

If you are not sure how to do this, put Disk 1 ('MS-DOS Startup and Utilities') in Drive A (the lefthand drive if you have two), hold down **Ctrl** and **Alt** and press **Del**.

2 If you have a floppy disk PC place your MS-DOS Startup disk (Disk 1) in Drive A (the lefthand drive if you have two).

This disk will already be in the drive if you have just switched on or reset the machine.

3 Make the root directory the current directory.

If you have just switched on or reset your AMSTRAD PC, you need not do anything. Otherwise, you may need to type:

```
CD \ ←
```

to return to working on the root directory.

4 Type:

DISKCOPY A: B:

What happens next depends on whether your PC has one or two floppy disk drives.

● **If you have a single-drive PC**

After a short while, you will see the following message on the screen:

Insert SOURCE diskette in drive A:
Press any key when ready . . .

5 Remove the MS-DOS Startup disk from the drive and insert the disk you want to copy.

Turn the drive handle anticlockwise to release the disk, then withdraw it completely from the drive and replace the disk in its paper cover. Insert the disk you want to copy in the drive and then turn the drive handle back across the drive slot.

6 Press a character key.

The key or the Space Bar is usually the most convenient choice.

After a short while, you will see the message:

Copying — *n* tracks
m Sectors/track, 2 side(s)

followed by:

Insert TARGET diskette in drive A:
Press any key when ready . . .

7 Remove the disk from the drive and insert the disk you want to store the copy on.

Turn the drive handle anticlockwise to release the disk, then withdraw it completely from the drive and replace the disk in its paper cover. Insert the disk you want to store the copy on in the drive and then turn the drive handle back across the drive slot.

8 Press a character key.

The key or the Space Bar is usually the most convenient choice.

If you are storing the copy on a new blank disk or on disk that has a different format to your Source disk, you will see the message:

Formatting while copying

Finally the message:

Copy another diskette (Y/N)?

9 Type if you want to copy another disk; type to leave DISKCOPY.

● **If you have a two-drive PC**

After a short while, you will see the following message on the screen:

Insert SOURCE diskette in drive A:
Insert TARGET diskette in drive B:
Press any key when ready . . .

5 Remove the disks currently in the drives and insert the disk you want to copy in drive A (your lefthand drive) and the disk you want to store the copy on in drive B (your righthand drive).

To remove a disk, turn the drive handle anticlockwise and then withdraw the disk completely from the drive. Replace the disks in their paper covers. Insert the disk you want to copy and the disk you want to store the copy on in their appropriate drives and then turn the drive handles back across the drive slots.

6 Press a character key.

The key or the Space Bar is usually the most convenient choice.

After a short while, you will see the message:

Copying - *n* tracks
m Sectors/track, 2 side(s)

If you are storing the copy on a new blank disk or on disk that has a different format to your Source disk, you will see the message:

Formatting while copying

Finally the message:

Copy another diskette (Y/N)?

7 Type if you want to copy another disk; type to leave DISKCOPY.

7.2 Preparing a new disk for use – Formatting

The storage area of a new disk needs to be marked out in sections electronically before you can use the disk to store any programs or data. This process is called formatting.

When you copy a disk onto a new blank disk, the new disk is automatically formatted for you as part of the copying process. You only have to remember to format the new disk when you want to have it ready to store, for example, the data files your spreadsheet program is about to produce.

The process can also be used with an old disk the data on which has become corrupted. If the disk hasn't been physically damaged, formatting the disk can reclaim all its storage space. However, before you do this, do be sure to copy as many as possible of your files to other disks before you reformat the disk. Formatting a disk wipes it clean of any stored data.

Note: The method described here prepares a disk for use simply to store programs and data. If you want to prepare a disk for use as a Startup disk (ie. to insert immediately after you switch your PC on), you should either turn to Part III, Section 6.2 or copy an existing Startup disk and delete all the files stored on it.

The steps you need to take are as follows:

1 Display an A> system prompt (or C> if you have a hard disk PC).

Return to Drive A as the default drive. If you are not certain how to do this, reset your machine – instructions for this are given in Section 8.3. If you have yet to switch on your PC, go through the Startup procedure described in Section 8.1.

2 If you have a floppy disk PC place your MS-DOS disk (Disk 1) in Drive A (your lefthand drive if you have two).

This disk will already be in the drive if you have just switched on or reset the machine.

3 Make the root directory the current directory.

If you have just switched on or reset your PC, you need not do anything. If you have been using MS-DOS command lines, you may need to type:

```
CD \ 
```

to return to working on the root directory.

4 Type:

```
FORMAT A: 
```

After a short while, you should see the following message:

```
Insert new diskette for drive A:  
and press RETURN when ready
```

5 Remove the Startup disk from Drive A and insert the disk you want to format.

To remove a disk, turn the drive handle anticlockwise to release the disk and then withdraw it completely from the drive. Replace the disk in its paper cover. Put the disk you want to format in the drive and turn the drive handle back across the drive slot.

6 Press the key.

The message: **Head:n Cylinder:m** will appear on the screen.

After a short while, messages similar to the following should appear on the screen:

```
Format complete  
nnnn bytes of disk space  
nnnn bytes available on disk  
Format another (Y/N)?
```

7 Type if you want to format another disk; type to leave FORMAT.

7.3 Copying a file

Copying a file makes a new file that contains all the same information as the original. This copy can be stored either in the same folder (or directory) as the original or in a different folder, often on a different disk.

The methods of copying described here make copies of one or more files. However, the files must all be in the same folder (or directory), so if you want to copy files from separate folders, you must repeat the process for each folder in turn.

The originals of the files are known as the 'Source' and where the copies are stored is known as the 'Destination'.

The steps are as follows:

1 Decide on the file or files you want to copy. These are described as your source files.

You can use one command line to copy a number of files provided these can be described by the same file template (ie. a file name covering a number of files by including the wildcard characters * and ? – see Section 8.5) and you don't want to store the copies in the same directory as the original files. If you want to make duplicate copies of files in the same directory you have to copy the files one at a time.

2 Jot down the drive, directory and file name (or template) you are going to use for the source file(s). These make up the *source-details* for the copy.

Write this down in the form *drive:\directory\file-name*. For example, if you want to copy all the files with the filename MYFILE in a directory called SUBDIR on Drive A, you would write:

A:\SUBDIR\MYFILE.*

if SUBDIR is listed in the Root (principal) directory on Drive A

A:\DIR1\SUBDIR\MYFILE.*

if SUBDIR is listed in the DIR1 directory, which is itself listed in the Root directory on Drive A

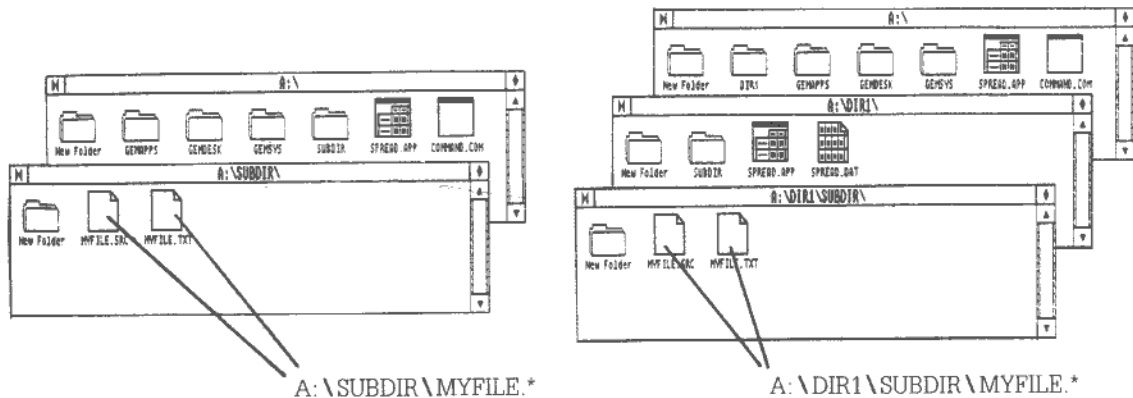

(Turn to Section 8.7 if you need extra help in working out what to write down.)

3 Decide on where you want to store the new files and what they are to be called. This is known as the destination of the copies.

Often you will want to store the copy in a different directory but under the same filename and filetype. Make sure that you don't already have any files with this filename and filetype already in your destination directory or, if you do, make sure that you no longer need the files.

It is also wise to check that there will be enough room for the new file on the destination disk – see Section 7.7, below.

4 Jot down the drive, directory and file name (or template) you are going to use for the destination file(s). These make up the *destination-details* for the copy.

Write this down in the form:

drive:\directory

if you want to use the file name(s) the source file(s) already have

drive:\directory\file-name

if you want to use different file name(s).

5 Type in the appropriate COPY command.

The command you need will be:

COPY *source-details destination-details*

MS-DOS then makes the copy (or copies) you have requested.

7.4 Deleting a file

Deleting files removes the information stored in them from your disk: this information cannot be recovered. You can delete files either one at a time or in a group (provided they are all in the same folder/directory).

The steps are as follows:

1 Decide on the file or files you want to delete.

You can use one command line to delete a number of files provided these can be described by the same file template (ie. a file name covering a number of files by including the wildcard characters * and ? - see Section 8.5).

2 Jot down the drive, directory and file name (or template) you are going to use. These make up your file-details.

Write this down in the form *drive:\directory\file-name*. For example, if you want to delete all the files with the filename MYFILE in a directory called SUBDIR on Drive A, you would write:

A:\SUBDIR\MYFILE.*

if SUBDIR is listed in the Root (principal) directory on Drive A

A:\DIR1\SUBDIR\MYFILE.*

if SUBDIR is listed in the DIR1 directory, which is itself listed in the Root directory on Drive A

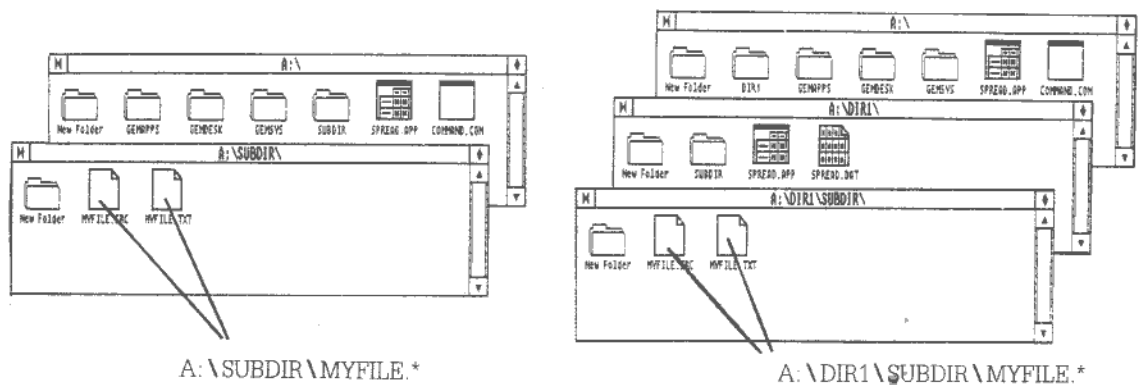

(Turn to Section 8.7 if you need extra help in working out what to write down.)

3 Type in the appropriate DEL command.

The command you need is:

DEL *file-details*

MS-DOS then deletes the files you have specified, unless you have asked it to delete all the files in the directory when it first puts up the message:

Are you sure (Y/N)?

Type if you do want all the files to be deleted; type and then redo your command line if you hadn't intended to delete all the files.

7.5 Renaming a file

Files do not have to keep the name they were given when they were created. In most cases, you can give a file a new name any time you choose.

The new name you choose should:

- be different from any other file or folder name in this folder
- suit the needs of the programs you are going to use to process the file (refer to the programs' user guides)
- remind you of the information the file is used to store

The usual characters to use in the name are the letters A...Z and the numbers 0...9, but you can use some other characters as well (see Section 8.4).

The steps are as follows:

1 Jot down the drive, directory and file name of the file you are going to rename. These make up your *file-details*.

Write this down in the form *drive:\directory\file-name*. For example, if you want to rename a file called MYFILE.TXT in a directory called SUBDIR on Drive A, you would write:

A:\SUBDIR\MYFILE.TXT

if SUBDIR is listed in the Root (principal) directory on Drive A

A:\DIR1\SUBDIR\MYFILE.TXT

if SUBDIR is listed in the DIR1 directory, which is itself listed in the Root directory on Drive A

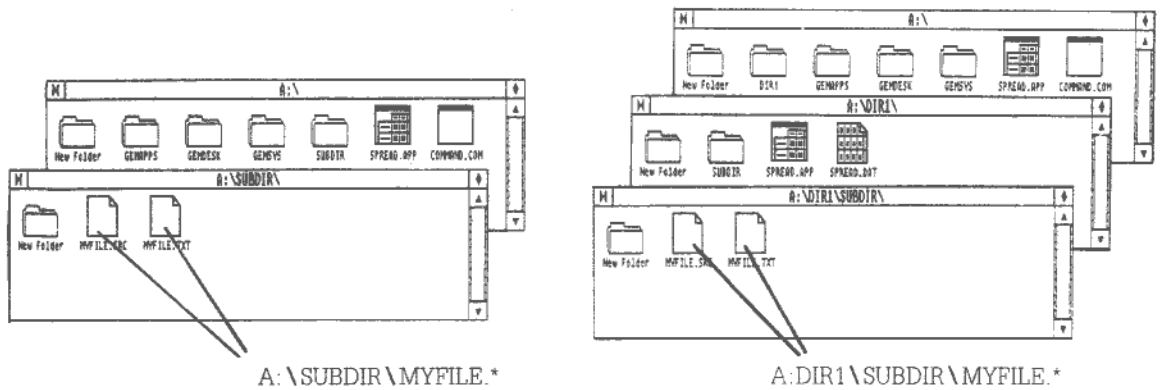

(Turn to Section 8.7 if you need extra help in working out what to write down.)

2 Jot down just the new file name you have chosen for the file.

For example, if you have decided to call the file MYFILE.VI write down MYFILE.VI

3 Type in the appropriate REN command.

The command you need is:

```
REN file-details new-name 
```

MS-DOS then renames the file, unless you have chosen a name that you are already using. In that case, it displays an error message and doesn't rename the file. If this happens, either delete the file that is causing the problem or choose another name before trying to rename the file again.

7.6 Finding out how large a file is

1 Jot down the drive, directory and file name of the file you want to know the size of. These make up the file-details.

Write this down in the form *drive:\directory\file-name*. For example, if you want to rename a file called MYFILE.TXT in a directory called SUBDIR on Drive A, you would write:

```
A:\SUBDIR\MYFILE.TXT
```

if SUBDIR is listed in the Root (principal) directory on Drive A

```
A:\DIR1\SUBDIR\MYFILE.TXT
```

if SUBDIR is listed in the DIR1 directory, which is itself listed in the Root directory on Drive A

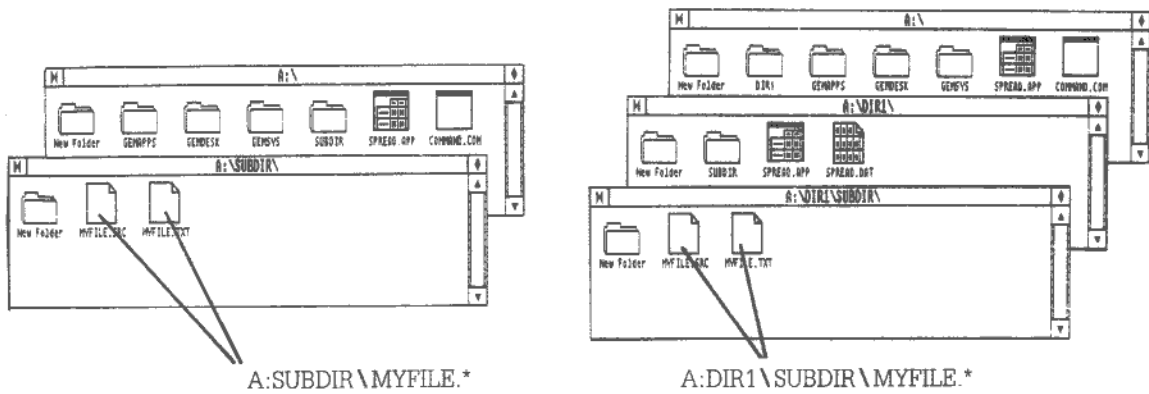

(Turn to Section 8.7 if you need extra help in working out what to write down.)

2 Type:

DIR file-details

Among the details that will appear on the screen will be the size of the file in bytes. (1000 bytes is about 1000 characters.)

7.7 Finding out how much unused storage space there is on a disk

1 Insert the disk you want to examine in Drive A (your lefthand drive if you have two) and close the drive door lock.

2 Type:

CHKDSK A:

If you have a Hard Disk type:

CHKDSK C:

After a little while, MS-DOS will display a report on the disk, which tells you (among other things) the number of bytes of storage space available on the disk. (1000 bytes holds about 1000 characters.) In the case of the Hard Disk this process may take a few minutes if there are a lot of files on the disk.

7.8 Using the Editor to create or change a text file

The AMSTRAD PC is supplied with a screen-based Text Editor called RPED, which is very useful for editing small text files. As it shows the file you are editing on the screen, it is very easy when you are using RPED to look over sections of the text file you are creating or changing, spot a mistake, move the cursor to this mistake and make your corrections.

The main use you are likely to make of RPED is for creating or updating files that have the filetype BAT, in accordance with instructions in your programs' user guides. (These guides may suggest you use the MS-DOS text editor EDLIN but you will probably find using RPED easier.) Other files are usually all created by the programs you run and updated by them as well.

The RPED program is stored on Disk 3 (GEM Desktop and BASIC 2).

Overview of using RPED

The first screen that RPED displays, tells you about the keys on your keyboard you will be able to use while you are working with RPED. It also asks you whether you want:

- to edit (ie. change) an existing file
- to immediately re-edit the file you have just finished editing
- to create a new file

and it tells you which key to press to make your selection. Put the disk holding the file you want to edit (or the disk you are going to store the new file on) in Drive A and then press the key appropriate to the job you want to do.

RPED then asks you questions about the file you want to edit. If you want to edit an existing file, RPED needs details of where this file is stored and of the file you want to store the edited version in because the new version doesn't have to replace the old version. If you want to re-edit the file you have just finished editing or you want to create a new file, RPED just asks you where the edited version is to be stored.

After you enter this information and press , you will see either the current version of the file displayed on the screen or a blank page ready for you to type in your new file. Messages on the screen tell you which keys to press to do such actions as:

- inserting a new line
- deleting a line

Running RPED

1 Display an A> system prompt.

Switch on and load MS-DOS, by following the Startup procedure given in Section 8.1 and using Disk 1 (MS-DOS Startup and Utilities) as the startup disk. If you are already using MS-DOS on your PC, finish what you are doing then return to an A> system prompt and type:

```
CD \ 
```

2 Place Disk 3 (GEM Desktop and BASIC 2) in Drive A (your lefthand drive if you have two).

Note: in the case a Hard Disk PC the RPED program should be already available in the root directory of disk C:.

3 Type:

RPED

After a short while, the following should be seen on the screen. This is RPED's opening screen:

```
This screen editor is for small files (up to 750 lines) and uses
normal Cursor, Page, Home, End, Insert and Delete keys.

      f1 = Edit Existing File
      f2 = Re-edit Previous File
      f3 = Create New File
      f4 = Quit
```

8. FUNDAMENTALS OF USING YOUR AMSTRAD PC

This chapter is a reference chapter in which you can quickly look up standard procedures like the AMSTRAD PC's Startup procedure, and other standard information such as how to construct a filename. The contents are as follows:

- 8.1 The Startup procedure
- 8.2 Switching off
- 8.3 Resetting your PC
- 8.4 About filenames
- 8.5 Using wildcards to specify a number of files
- 8.6 About folder and directory names
- 8.7 Specifying a path
- 8.8 Cleaning your PC

8.1 The AMSTRAD PC Startup procedure

If anything happens as you work through this Startup procedure that is not explained here, turn to the 'troubleshooting' section, Appendix VII.

Note: In this Startup procedure, you can use

- the Startup disks supplied with your AMSTRAD PC (or copies of these)
- any other disk with Operating System software on it. This includes commercial program disks that have been set up so that you can just turn on your computer and run the programs - so-called 'Turnkey' programs.

1 Start with

- the mains plug out of the supply socket
- the power switch on the back of the Display in its OFF position (fully released)
- no disk in any floppy disk drive

2 Plug the Display into the mains supply and then turn the machine on by pressing the power switch.

Your PC then goes through a built-in system check. If all is well, a message similar to the following will shortly appear on the screen:

```
AMSTRAD PC 640K (v3) 09:00 on 1 September 1988
(c)1987 AMSTRAD Consumer Electronics plc
Last Used at 15:00 on 30 August 1987
```

Note: The first time and date displayed is the current setting of the on-board clock. The second time and date records when you last finished using the operating system supplied with your machine. If you use a different operating system on your AMSTRAD PC, the time and date shown will record when you last switched your PC on.

If the date displayed is plainly wrong (for example, 1 January 1980), you have not set the date and time since you changed the batteries or the batteries have started to

go flat. The AMSTRAD PC only puts up a message reminding you to do this once. The date and time can be set either by setting the GEM Desktop clock (see Part II, Section 6.2) or through the MS-DOS DATE and TIME commands (see Part III, Section 7.3).

If the batteries have become flat, there will be no details of when your PC was last used. Instead, the PC will bleep and request you to set the date and time, set the user options (if required) and fit new batteries. How to set the user options and how to fit new batteries are described in Appendix II 'Setting up the Battery Backed RAM'.

In both of these cases, you are advised to set the date and the time, etc. but your PC will still work if you don't.

If the keyboard is not connected properly, or something is holding down keys on the keyboard, the following message will appear:

Check Keyboard and Mouse

Clear everything off the keyboard and check that none of the keys are stuck down. Similarly, check that neither of the mouse buttons is stuck down. Finally, check that both the keyboard and the mouse are properly connected to the System Unit. The message will disappear when you clear the problem.

3 Insert your Startup disk (ie. the disk holding the system software you want to load) into Drive A.

Note: In the case of a Hard Disk PC there is no need to insert a startup disk (unless you wish to override the operating system loaded automatically from hard disk).

- To load MS-DOS, insert Disk 1 of your AMSTRAD PC disks
- To load the GEM software, insert Disk 1 of your AMSTRAD PC disks.
- To load a 'Turnkey' program, insert the program disk

To use the GEM Desktop, you will also need Disks 2 and 3 at this stage.

IMPORTANT: WORK IF POSSIBLE WITH COPIES OF DISKS RATHER THAN WITH THE ORIGINALS. KEEP THE ORIGINALS SAFELY STORED AWAY AS YOUR MASTER COPIES FOR USE IN CASE OF ACCIDENT TO MAKE FURTHER COPIES FOR YOU TO USE.

Insert the disk into the slot in your disk drive. If you have two disk drives, insert it into the slot of your lefthand disk drive. When the disk is fully inserted, close the drive by turning the drive handle across the drive slot: this holds the disk in the drive.

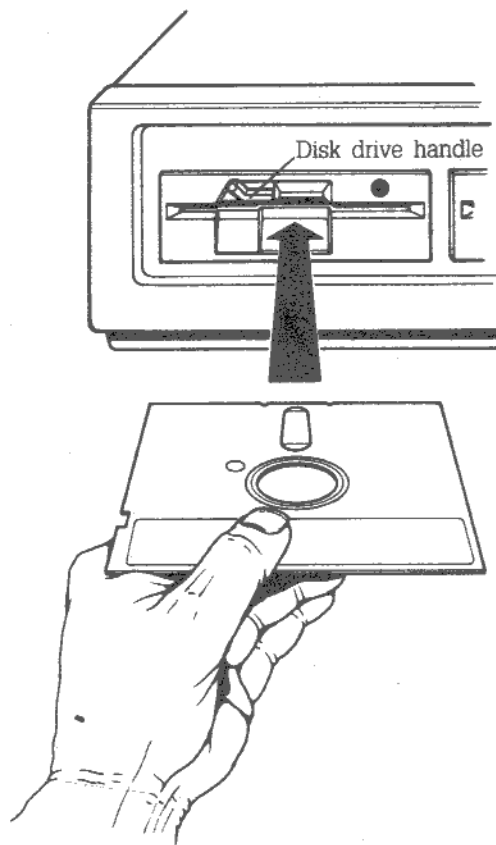

If you pause for any length of time before doing this, the following message will appear on the screen:

**Insert a SYSTEM disk into drive A
Then press any key**

4 Press any key on the keyboard.

The space bar or the Carriage Return key () is usually the most convenient choice.

The AMSTRAD PC then reads the system software from this disk. You will see the green indicator light on the drive go on and off a few times while this is happening.

The screen will clear after a short while and the following message will be displayed:

```
A>ECHO OFF  
---Installing MOUSE Device Driver V5.00---  
A>
```

To load GEM, type GEM and follow the instructions on the screen. If you have a floppy disk PC you will be asked to insert the AMSTRAD PC GEM startup Disk (Disk 2).

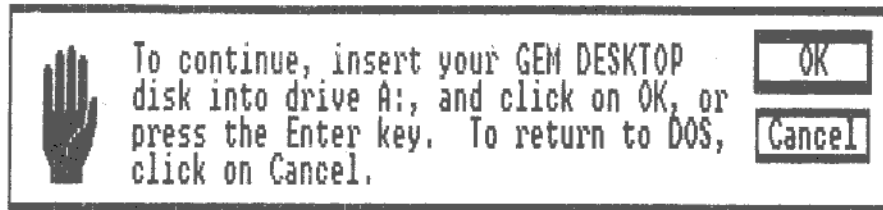

To work from the GEM Desktop, turn the drive handle anticlockwise to release Disk 2 and withdraw it from the drive. Replace it by your GEM Desktop disk (Disk 3) and turn the drive handle back across the drive slot. Then press the Carriage Return key (). The Desktop will then be loaded.

8.2 Switching off

- 1 **Check that your PC isn't reading any data from your disks or writing data to them.**

The indicator light on the disk drive is either fully on or flashing on and off if the AMSTRAD PC is reading or writing data to a disk drive.

- 2 **Turn the drive handle anticlockwise (from vertical to horizontal) on each floppy disk drive.**

This automatically releases the disk from the drive.

- 3 **Withdraw the disk(s) from the drive(s) and replace them in their paper covers.**

- 4 **Only then, switch your PC off by pressing and releasing the power button: this fully releases the button.**

ALWAYS REMEMBER TO REMOVE YOUR DISK(S) FROM THE DISK DRIVE(S) BEFORE YOU SWITCH OFF

ALWAYS WAIT FOR AT LEAST FIVE SECONDS BEFORE SWITCHING BACK ON

8.3 Resetting your PC

 +  + 

Resetting your PC clears its memory so that you can start using the machine afresh. It is often used to change from using one application software package to another or after a program has failed.

- **You should not reset your PC when there is important information currently held in its memory without considering whether this information can be saved to disk first.**

Resetting your PC clears its memory. Any information that hasn't been saved onto disk will be lost.

The steps to take are as follows:

- 1 **Remove the disk(s) currently in the drive(s)**

To remove a disk, turn the drive handle anticlockwise to release the disk and then

withdraw the disk completely.

2 Hold down both the **Ctrl** and **Alt** keys and press the **Del** key.

3 If you have a floppy disk drive PC insert your Startup disk into Drive A (your lefthand disk drive if you have two).

Note: In the case of a Hard Disk PC there is no need to insert a startup disk (unless you wish to override the operating system loaded automatically from hard disk).

- To load MS-DOS, insert Disk 1 of your AMSTRAD PC disks
- To load the GEM software, insert Disk 1 of your AMSTRAD PC disks.
- To load a 'Turnkey' program, insert the program disk

If you want to work with the GEM Desktop, you will also need Disks 2 and 3 at this stage.

To load GEM, type **GEM** and follow the instructions on the screen. If you have a floppy disk PC you will be asked to insert the AMSTRAD PC GEM Startup Disk (Disk 2).

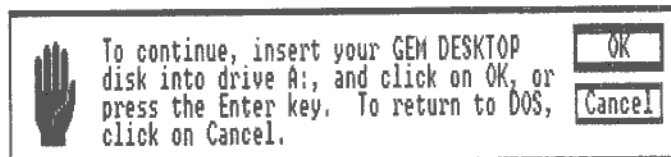

To work from the GEM Desktop, turn the drive handle anticlockwise to release Disk 2 and withdraw the disk from the drive. Replace it with your GEM Desktop disk (Disk 3) and turn the drive handle back across the drive slot. Then press the Carriage Return key (**Enter**). The Desktop is then loaded.

8.4 About filenames

The rules about what you can call a file are laid down by a computer's operating system, which on the AMSTRAD PC is MS-DOS. Files are usually identified by a two-part name. The first part is called the Filename and the second part is called the Filetype. In some cases, the file has just a filename and no filetype.

Confusingly, people often refer to both the filename and the filetype together as the filename. This is never done in this manual, though the term file name may be used to represent both the filename and the filetype.

The filename is any combination of 1 to 8 characters, starting with one of the letters of the alphabet or a number. The characters you can use are given in columns 3 to 8 on the lefthand page of the table in Appendix III. However, the following special characters can't be used:

< > = | / [] , . : ; \ + { } ! * ? " ^

and you may not put spaces into a filename.

For example, the following filenames are valid:

```
A
AAAAAAA
123
```

The following filenames are invalid:

A23[4] Includes one or more special characters
AAAAAAAAA Too many characters

Often just the letters of the alphabet A...Z and the digits 0...9 are used. As far as filenames go, lower case letters (ie. a...z) are exactly the same to MS-DOS as upper case letters (ie. A...Z). For example, the filename **Cat** is identical to the filename **cat** or **CAT**.

Note: The filenames **AUX**, **CON**, **COM1**, **COM2**, **LPT1**, **LPT2**, **LPT3**, **LST**, **NUL** and **PRN** have special meanings and should not be used for your own files.

The filename will usually be chosen to remind you about the information the file holds but this doesn't have to be so.

The filetype is up to three characters long and again the special characters and spaces can't be used. But unlike the filename, the filetype can be fixed by the information the file holds. For example:

- files containing programs which run directly from the MS-DOS operating system must have the filetype COM or EXE.
- files containing programs set up for working with the GEM software have the filetype APP
- files containing BASIC programs have the filetype BAS

Always check in your program's user guide to see if the data files associated with this program must have a particular filetype. If no filetype is specified, choose one yourself.

Any valid name can be used for a file provided the same name hasn't already be used for another file in the same folder or directory.

When you want to specify a particular file, you write its name as *filename.filetype*: for example, if the *filename* is MYFILE and the *filetype* is TXT, you would write the complete name as MYFILE.TXT (You must always remember to put the full stop between the filename and the filetype.)

8.5 Using wildcards to specify a number of files

Some programs are able to work on a number of files, one after another. You can make use of this to save yourself typing a separate instruction for each file provided you can construct a 'template' that at least some of your chosen files will match. The 'tools' you can use in constructing this template are two special characters called wildcards because they can represent any valid character. The two wildcards are:

- ? which represents one valid character (or blank) in this place in the name
- * which represents any number of valid characters (including blank) finishing off this part of the file's name

For example, suppose a directory contained the following files:

A.COM, **AB.COM**, **ABB.COM**, **B.COM**, **A.BAT** and **B.BAT**

?.COM would be the template for **A.COM** and **B.COM**

***.COM** would be the template for **A.COM**, **AB.COM**, **ABB.COM** and **B.COM**

Both **?.BAT** and ***.BAT** could be the template for **A.BAT** and **B.BAT**

A?.COM would be the template for A.COM and AB.COM
A*.COM would be the template for A.COM, AB.COM and ABB.COM
A.* would be the template for A.COM and A.BAT
?.* would be the template for A.COM, B.COM, A.BAT and B.BAT
. would be the template for all the files

Note the use of a separate asterisk for the filename and the filetype parts of the file's name.

8.6 About folder and directory names

Directories and folders are the same thing – the groups of files that you can use to make your files more manageable. Thus the discussion below about what names folders can have applies directly to choosing directory names.

The names that can be given to folders on the AMSTRAD PC are like the names that can be given to files. Again the name is split into two parts – a Name and a Type. In practice, the Type part of the name is rarely used.

The Name is any combination of 1 to 8 characters, starting with one of the letters of the alphabet or a number. The characters you can use are given in columns 3 to 8 on the lefthand page of the table in Appendix III. However, the following special characters can't be used:

< > = | / [] , . : ; \ + { } ! * ? " ^

and you may not include any spaces in the name.

For example, the following names are valid:

A
AAAAAAA
123

The following names are invalid:

A23[4] Includes one or more special characters
AAAAAAAAA Too many characters

Often just the letters of the alphabet A..Z and the digits 0..9 are used. Note: Lower case letters (ie. a..z) are exactly the same to MS-DOS as upper case letters (ie. A..Z). **Cat**, for example, is exactly the same as **cat** or **CAT**.

Note: You must not use the names **AUX**, **CON**, **COM1**, **COM2**, **LPT1**, **LPT2**, **LPT3**, **LST**, **NUL** and **PRN**.

The Name will usually be chosen to remind the user about the files the folder holds but this doesn't have to be so.

The Type is up to three characters long and again the special characters and spaces can't be used. There are no conventions governing the combination of characters used.

A folder can be given any valid name provided it is not already the name of a folder in the same directory.

Folder names are used to describe paths to the folder holding the files you want to use. How this is done is described below.

8.7 Specifying a path

A 'Path' is used to direct MS-DOS to a particular folder on a DOS disk. It is a list of the folders between a point the operating system recognises and the new directory.

The starting point for the path is:

- either the root directory on the drive
- or the directory (folder) you are currently working with on the drive

You can use the path from the Root directory regardless of which directory you are currently working with.

Suppose, for example, that you knew that the structure of directories on the disk was:

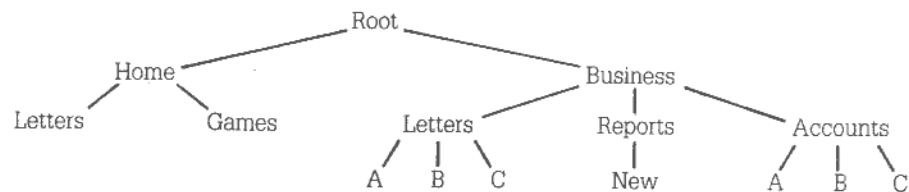

Paths from the Root directory

To work out the path you need, you start at the Root directory and list all the names on the way to the directory you want (including the name of this directory). The path is these names, written down in order and separated by backslashes (\).

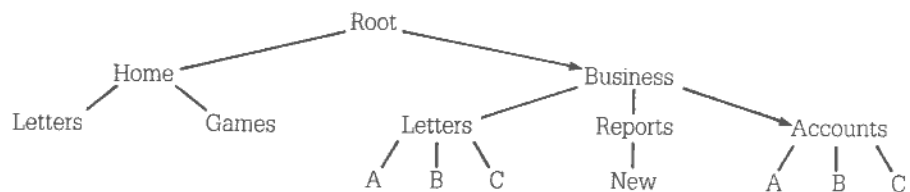

For example, to direct the operating system to the 'Accounts' directory, the names on the way are:

'Business' and 'Accounts'

and so the path is:

BUSINESS\ACCOUNTS

When you come to use this path, for example to specify a file in the directory, you precede it by a backslash (to tell the operating system that the path starts at the Root directory). If you are specifying a file, you would put another backslash at the end of the path, to separate the path from the file name that immediately follows it.

For example, to specify a file called NEW.A in the Accounts directory, you would write:

\BUSINESS\ACCOUNTS\NEW.A

Paths from the current directory

To work out the path you need, you start at the current directory and, working up or down the tree as necessary, list all the names on the way to the directory you want (including the name of this directory). The path is these names, written down in order and separated by backslashes (\).

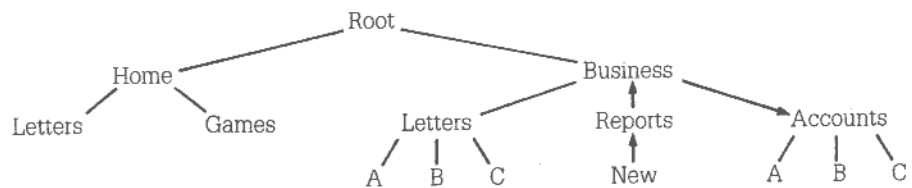

For example, suppose the current directory is 'New'. To direct the operating system to the 'Accounts' directory, the names on the way are:

'Reports', 'Business' and 'Accounts'

and so you could write the path as:

REPORTS\BUSINESS\ACCOUNTS

However, 'Reports' is the Parent directory of 'New' and 'Business' is the Parent directory of 'Reports', and there is a shorthand way of writing Parent which is ..

So the path you would actually write is:

..\..\ACCOUNTS

When you come to use this path to specify a file in the directory, you would put a backslash at the end of the path, to separate the path from the file name that immediately follows it. **You would not put a backslash at the beginning of the path.**

For example, to specify a file called NEW.A in the Accounts directory, you would write:

..\..\ACCOUNTS\NEW.A

8.8 Cleaning your AMSTRAD PC

We recommend the use of aerosol anti-static foam cleaners to clean both the screen and the plastic case. Under no circumstances should spirit-based cleaners be used.

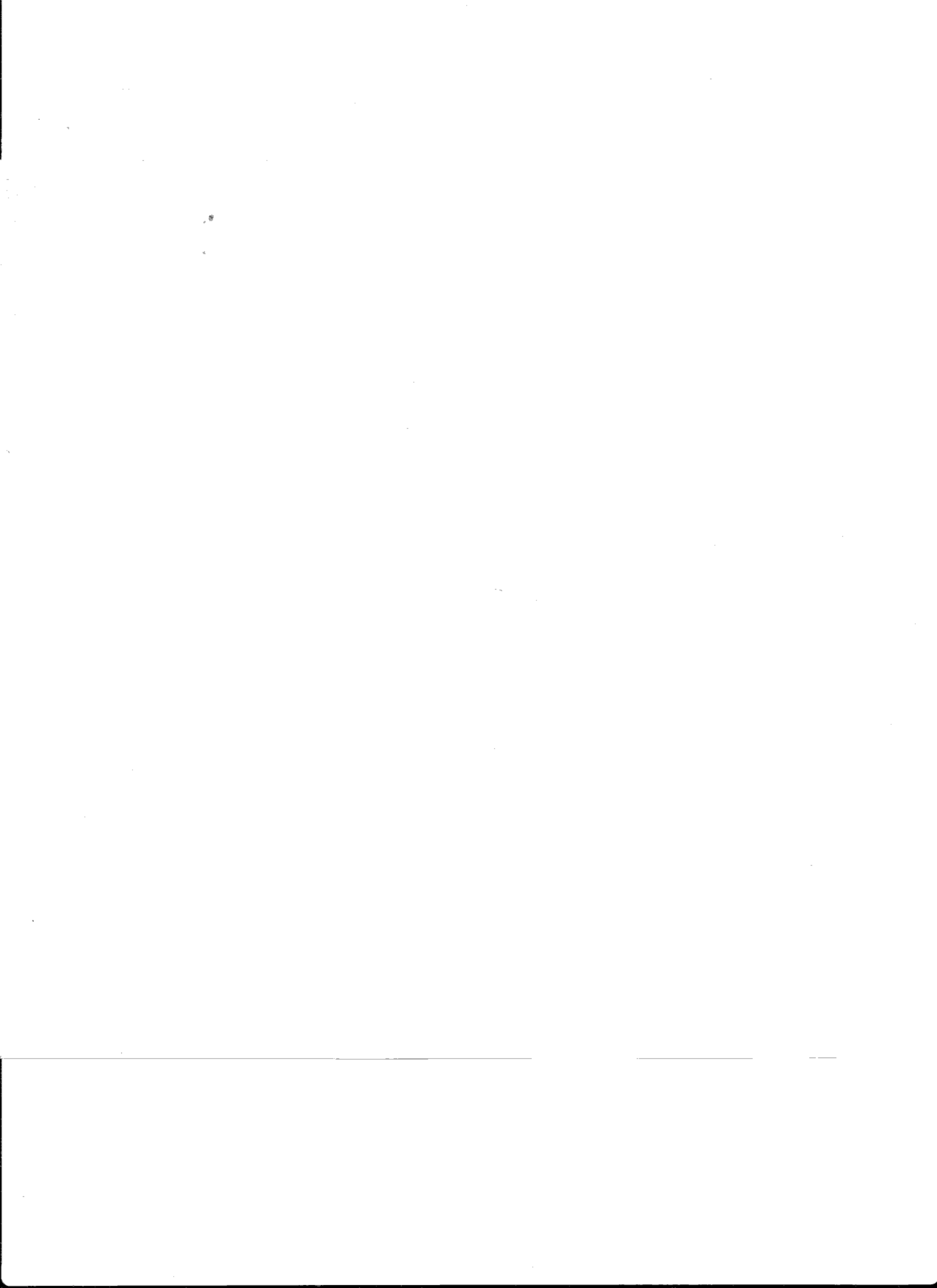

PART II: USING THE GEM DESKTOP

THE UNIVERSITY OF CHICAGO

CONTENTS

1. Introduction to GEM	117
What GEM offers	117
The GEM Desktop	118
The tasks you can carry out	119
2. GEM techniques	121
2.1 The components	121
About the pointer; About the hour glass symbol	
2.2 Using the mouse buttons	122
2.3 About icons	122
2.4 Actions with icons	124
Selecting an icon; Selecting a group of icons; De-selecting icons; Opening an icon; Dragging an icon	
2.5 About menus	129
2.6 Actions with menus	130
Pulling down a menu; Selecting an option; Closing up all menus; The alternative to using the menu	
2.7 About windows	131
The Title bar; The Scroll bars; The Close box; The Full box; The Size box	
2.8 Actions with windows	134
Changing the size of a window; Moving a window; Scrolling a window; Changing the active window; Closing a window	

2.9 About Dialog boxes	140
2.10 Actions with Dialog boxes	141
Selecting a Dialog box option; Entering information in a Dialog box; Changing information in Dialog boxes	
2.11 Selecting items through the Item Selector Dialog Box	143
Changing which folder is displayed in the window; Making your selection	
2.12 Changing over to using a different disk	146
2.13 Moving over to using DOS commands	146
Leaving GEM temporarily; Moving over to using DOS completely	
3. <i>Running programs under GEM</i>	149
3.1 Installing a program	150
3.2 Configuring a program	150
3.3 Running a program	152
3.4 Returning to the GEM Desktop	154
4. <i>Organising your work</i>	155
4.1 Organising files	155
4.1.1 How GEM shows your files and folders	156
4.1.2 Ways of sorting the directory	158
4.1.3 Finding out what is stored in a folder	159
4.1.4 Getting brief information about a folder, program or document	161
4.1.5 Finding out how much room there is on a disk	162

4.2 Disk housekeeping	163
4.2.1 Creating a new folder	163
4.2.2 Copying existing files and folders	164
4.2.3 Deleting files and folders you no longer require	167
4.2.4 Giving a file a new name	168
4.2.5 When names conflict	169
4.2.6 Protecting important files	170
5. Processing your disks	173
5.1 Preparing a new disk for use (Formatting)	173
5.2 Copying a disk	174
6. Using the Desktop accessories	177
6.1 Using Snapshot	177
Taking a picture	
6.2 Using the clock	179
Displaying the date and time; Setting the time; Setting the date; Displaying the alarm time; Setting the alarm	
6.3 Using the calculator	181
Entering a number; Selecting a function key; Using the memory functions	
7. The Desktop menus	185
7.1 The File menu	185
7.2 The Options menu	185
7.3 The Arrange menu	186
7.4 The Desktop menu	186

8. Personalising the GEM Desktop	189
8.1 Setting the features you want	189
8.2 Saving the Desktop	191
9. Outputting pictures and documents	193
Introduction	194
Overview of GEM OUTPUT	194
Displaying one or more files	194
9.1 Setting up an Output List	199
9.1.1 Preparing an initial list	199
9.1.2 Changing the list	203
9.1.3 Saving your Output List	205
9.1.4 Closing up the list currently on the screen	206
9.2 Setting up your Output Devices	207
9.2.1 Setting up the individual Output Devices	207
9.2.3 Saving your device settings	212
9.2.3 Using a saved set of device settings	212
9.3 Outputting pictures	213
9.4 The OUTPUT menus	214
9.4.1 The File menu	214
9.4.2 The Edit menu	215
9.4.3 The Options menu	215
9.5 Using the Print Spooler	216
10. Alternatives to using the mouse	217

1. INTRODUCTION TO GEM

Digital Research's GEM software presents the facilities of your PC and the facilities of the programs you run through pictures and menus. This lets you tell your PC what you want to do by simply pointing at the item on the screen and clicking the mouse button. This way of working is very easy to learn and after you have used one program that works in this way, you will find using others even easier.

An increasing number of programs are being written to make use of GEM's user friendly features. These programs are identified as 'working with the GEM software' or as being 'GEM-based'.

When your AMSTRAD PC is supplied, it is set up for this way of working. A few special techniques need to be learnt – for example, how to tell your PC that you want to work with a particular item on the screen – but these are really quite easy to pick up. The details are given in the next chapter. First, we describe the general features GEM has, because then you will be able to see where the various techniques slot in.

What GEM offers

Working with GEM is like working on sheets of paper at a desk. Each sheet of paper is represented on the screen by a rectangular area called a Window. You can have up to four windows on the screen at the same time – either laid side by side or one on top of another, just as you might arrange the papers you work on at your desk.

The area of the screen representing a sheet of paper is called a window because it gives the same effect as a rectangular opening in a solid piece of card mounted over a page of information. How much of the page is seen in the window depends on how big the window is relative to the page.

Some programs fix both the size of the page and the size of the window so that the whole page is displayed. Other programs may set up windows that only look at a section of the page at a time: to see other sections of the page you need to move the page behind the window by a process called 'scrolling the window'. Some GEM-based programs also let you change the size of the window you are working with.

How many windows you use at any time and what you have displayed in the different windows depends on the program you are running. Your program might, for example, let you use one window for your instructions to the program and the others to display the results.

Generally, you only work on one window at a time but you can readily change which window this is. At your desk, you can always put the current sheet of paper aside and bring the next one you want to work on to the top of the pile. Similarly, when you are using GEM you can put the current window you are working on aside and move over to working on another window. The window you are working on is always on the top of the pile: it is called the Active Window.

The programs you run are likely to offer a choice of actions and ask you to select an option. Programs that work with the GEM software may offer you these options through:

- pictures on the screen called icons
- menus, each of which enables you to select from a group of options
- messages on the screen called Dialog boxes which ask you either to select options or to type in information at the keyboard

The GEM Desktop

The GEM Desktop is the part of the GEM software that is used specifically for starting programs running and for organising your work.

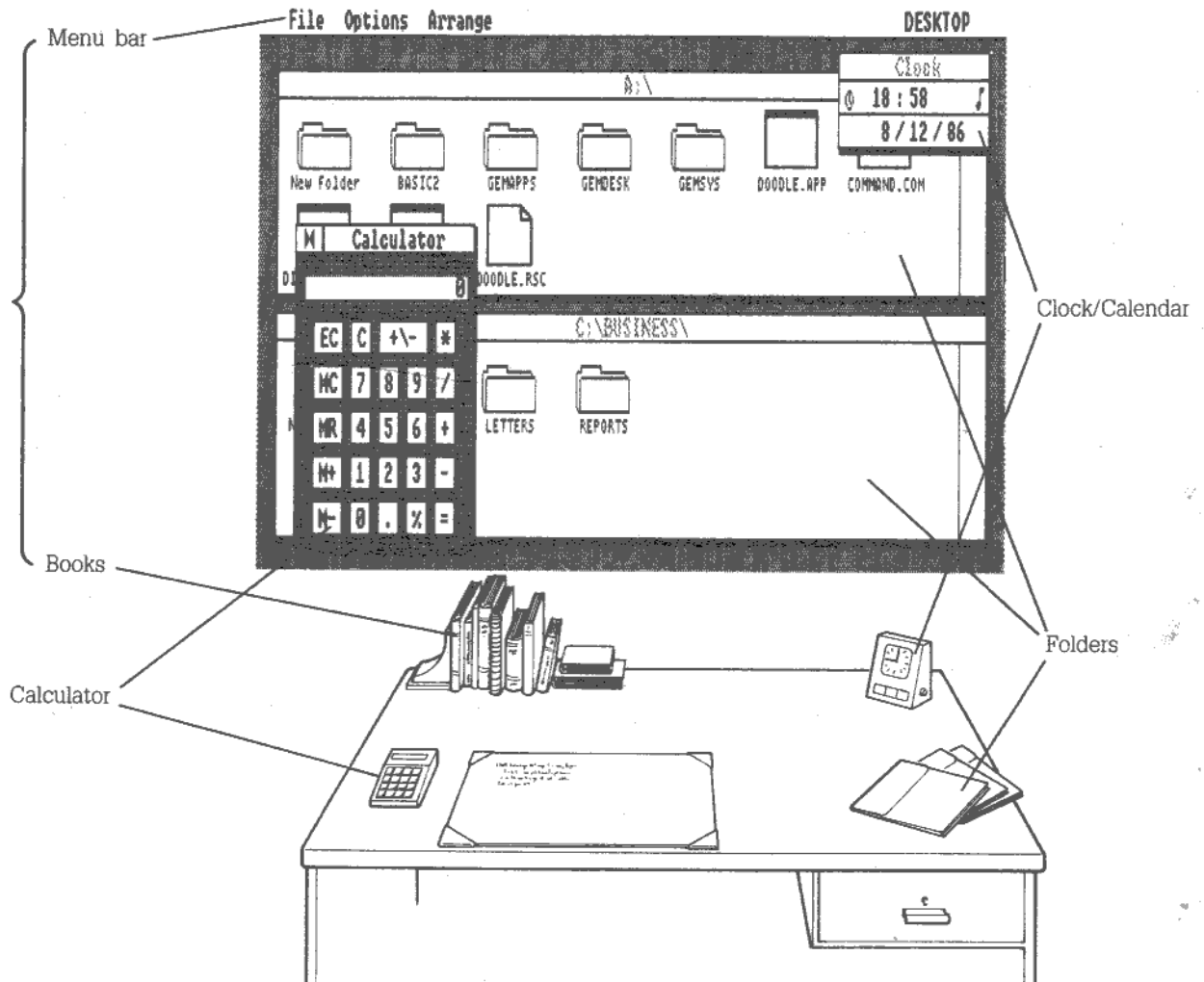

The GEM Desktop is in many ways like an office desk. It has a working area (the screen), a selection of items to work on (represented by icons), tools to work with (presented as options within the menus) and a clock and a calculator permanently to hand.

The items you can work on are the contents of folders you have on your disks. Folders on your disks, like the folders in your filing cabinet, hold either program and data files or further folders. You can either have one folder occupying the whole screen or two folders, each occupying half of the screen.

The folders that are displayed are the ones you are currently working with. These can be selected from any part of your filing system: if you have two disk drives, you can display folders from different disks at the same time. Which folder you show in one window in no way affects which folder you can show in the other window.

When you want to move to working on different folders, you close folders that are no longer of interest to you and then open the folders which you now want to use.

To get GEM Desktop to do useful work for you, you:

- 1 arrange to show the correct folder on the screen**
- 2 move the pointer to the item you want to work with on the screen (for example, a folder or a program file)**
- 3 click the lefthand button on the mouse to tell your PC you select this item**
- 4 pull down one of the menus and select the action you require**

What happens next simply depends on the specific job you have asked GEM Desktop to do for you.

The tasks you can carry out

To conclude this introduction to GEM, here is a brief summary of the sort of jobs you do through the GEM Desktop. They are described in detail in the remaining chapters of this part of the manual.

● **Running programs**

The programs you run from GEM Desktop do not have to be specifically GEM-based, ie. designed to use icons and menus. You can run any program. All you need to do is select the program you want and 'open' it. ('Opening' items on the screen is a standard GEM technique.) GEM Desktop will then prompt you for any additional information it needs to run this program. (The chapter that describes running programs also describes how to tell GEM Desktop what information to ask for.)

● **Organising your work**

Efficient use of your PC comes from keeping your program and data files in manageable groups. To help you do this, you can:

- create new folders in which to keep program and data files
- throw away files and folders you no longer need
- make copies of files and folders for storage elsewhere in your system

-
- give files new names
 - protect important files against accidental deletion

- **Screen graphics**

A number of GEM-based programs paint pictures or draw diagrams on the screen and let you store these pictures in files on your disk. You can bring these pictures back to your screen or output the pictures on a printer or a plotter, if you have one, by using a special part of the GEM software called GEM OUTPUT. This can be run from the GEM Desktop and from some GEM programs.

2. GEM TECHNIQUES

Using the GEM Desktop to run programs and organise your files requires you to:

- pick out items on the screen
- open files and folders to use them
- select a command from those listed in the menus
- respond to the messages that are put up on the screen

This chapter describes the techniques needed to carry out these tasks. Because it describes all the techniques you may use, it contains more information than you will need simply to run a program. If you are eager to run programs you have bought, Chapter 5 in Part I of this manual gives step by step instructions on how to start a program running from GEM.

2.1 The components

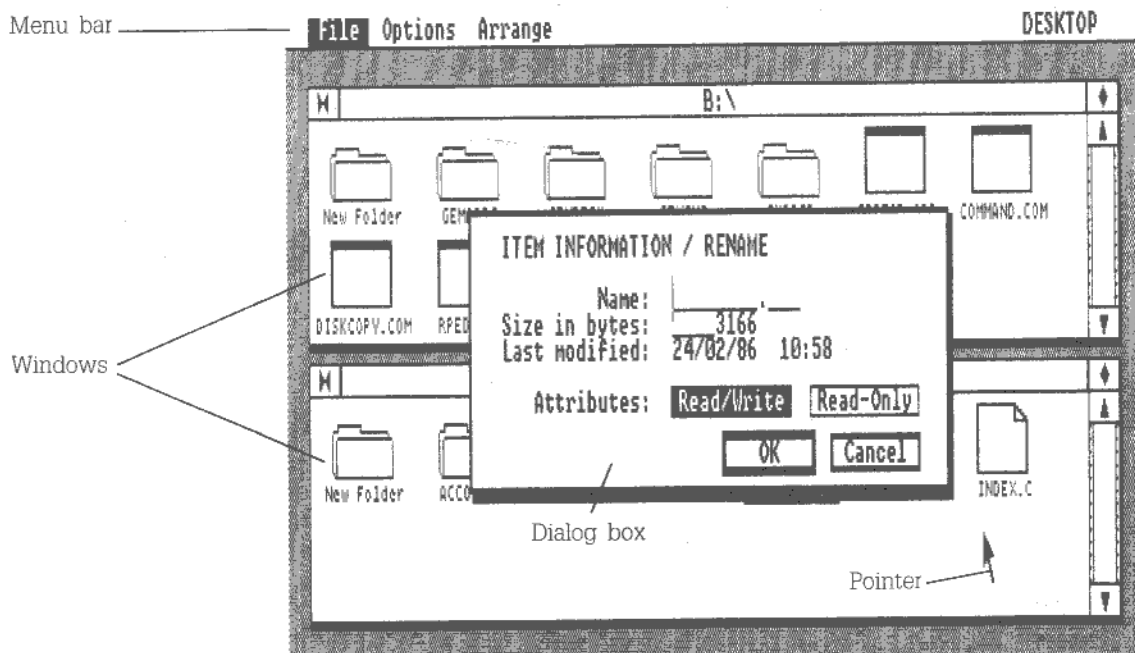

About the pointer



The pointer lets you pick out the item on the screen you are interested in. It can take a number of shapes – for example, your program may use a pointer looking like a hand. The arrow shown here is the type of pointer used by GEM Desktop.

You move the pointer by moving your mouse across something solid like the top of your table. If you want to move the mouse without moving the pointer, lift the mouse off the table to move it. Don't push it or pull it across the table.

Note: You don't have to use the mouse to move the pointer, though it is generally the easiest way. Other options are available if, for example, your mouse stops working. These are described in Chapter 10 'Alternatives to using the mouse' towards the end of this part of the manual.

About the hour-glass symbol



From time to time the pointer is replaced on the screen by a small picture of an hour glass. All this indicates is that GEM Desktop is busy processing your last instruction.

Wait until the pointer returns to the screen before trying to do anything else: it shouldn't be off the screen more than a few moments.

2.2 Using the mouse buttons

There are four different actions with the mouse buttons:

- **a quick press and release of the lefthand button**

This is called 'clicking the mouse button' or just 'clicking'. You will also see instructions like 'click on the icon' or 'click on the box': these mean 'move the pointer to the icon/box and click the lefthand button on the mouse'.

- **two clicks of the lefthand button in quick succession**

This is called 'double-clicking' and can be troublesome. If you find double-clicking awkward to do, there is always an alternative you can use.

- **press and hold down the lefthand mouse button**

This is used in 'dragging' either a window or an icon

- **hold down the righthand mouse button and click the lefthand one**

This is called 'Shift-clicking' because you can get exactly the same effect by holding down the Shift key, , on the keyboard and clicking the lefthand button. Using the two mouse buttons is easier, but the Shift key and the lefthand mouse button can always be used instead.

2.3 About icons

GEM uses special stylised pictures to represent the different objects it can manipulate. These are called icons.

There can be any number of different icons. GEM programs you buy are likely to use their own set of icons. The ones shown here are the ones used by the GEM Desktop.



represents a floppy disk



represents a built-in disk (either a hard disk or a special area of the computer's memory that can be used to store program and data files)



represents a 'folder', which can hold programs, documents or other folders



represents a program you can run from GEM Desktop



represents a document, holding data that is processed by a program or data that was produced by a program

The name under each icon is there so that you can distinguish, for example, between two different folders or between two different documents.

The picture on program icons illustrates the sort of program it is (see below). If the icon is blank, then the program hasn't been put in any particular category.

Each program processes or generates a particular type of document. These are also identified by the picture within the document icon.



a program that paints pictures on the screen



a program that draws diagrams on the screen



a program that draws graphs



a word processor



a spreadsheet



an accounts program



a 'multi-function' program, handling text, graphics etc.



a database program



an educational program



a games program



a communications program, handling data sent along communications links



a programming tool, such as an assembler



Locomotive BASIC 2



project planner



a program that handles your output devices





Note: Documents with the same icon picture don't have to be associated with the same program. For example, you may have two education programs, both of which will produce documents with 'ABC 1+1=2' on them. The best way to avoid getting confused is to store these documents in different folders (see Section 4.2).

2.4 Actions with icons

The actions you can carry out are:

- **to select an icon or a group of icons**

This tells GEM Desktop that you want to work with these items

- **to open an icon**

If the icon is a disk or a folder, this shows you what folders, programs and documents it contains: if the icon is a program, this runs the program

- **to drag an icon or group of icons**

This starts the process of duplicating ('copying') the item represented by the icon

Note: The procedures described here all use the mouse. Other methods are described in Chapter 10 'Alternatives to using a mouse'.

Selecting an icon

1 Move the pointer to any part of the icon or its name.



2 Click the lefthand mouse button once.



The icon is highlighted, ie. its outline is now drawn in thick lines and its name written in light characters on a dark background. This shows that the icon has been selected. You can now use options presented in the menus to process this icon. (How to select options from menus is described below in Section 2.6)

Selecting a different icon

- 1 Move the pointer to the icon you now want to select.



The icon you now want to select

- 2 Click the lefthand mouse button once.



The icon that had been selected is now returned to its normal unselected state. The new icon that you picked out is now selected (outlined in thicker lines and with its name in light text on a dark background).

Selecting a group of icons

- If you can draw a rectangle round all the icons you want without enclosing more than one or two icons you don't want:

- 1 Move the pointer to the top lefthand corner of this imaginary rectangle.

Icons you want to select

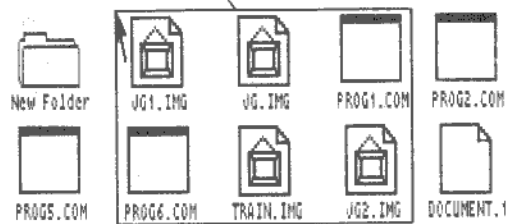

- 2 Press and hold down the lefthand mouse button. Then, without releasing the button, move the pointer to the bottom righthand corner of your imaginary rectangle.

You will see a dotted rectangle (a 'rubber rectangle') being marked out on the screen as you move the pointer. When the pointer has reached the right position, the dotted rectangle will enclose the icons you want.

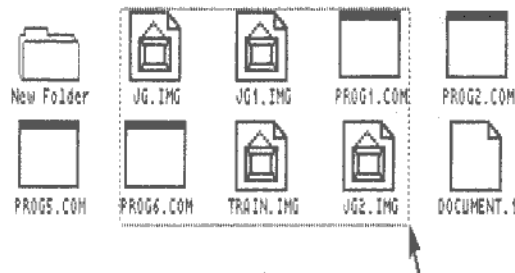

3 Release mouse button.

All the icons in the group are now highlighted. This shows that all the icons have been selected.



4 De-select any icons that you don't want by Shift-clicking on these icons.

Move the pointer to each icon in turn, hold down the righthand mouse button and click the lefthand button once. If you don't hold down the righthand button, you will de-select all **except** the one you were pointing to!

● If the icons you want are scattered over the window:

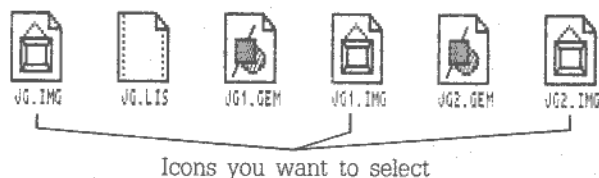

1 Press and hold down the righthand mouse button.

2 With the righthand button still held down, move the pointer to each icon you want to select in turn and click the lefthand mouse button.

This selects the icons one by one.

- Note:** (i) Make sure that the righthand button is held down when you press the lefthand mouse button. If it is not, you will lose all the icons you have selected so far!
(ii) What has been described here is the Shift-clicking technique (see Section 2.2).



De-selecting an icon or group of icons

- **If you want to de-select everything that you have selected so far:**

1 Move the pointer into a clear area in either window.

2 Click the lefthand mouse button once.

The icons that had been selected are now returned to their normal unselected state.

- **If you just want to de-select one of a group:**

1 Move the pointer to the icon you want to de-select.

2 Hold down the righthand mouse button and click the lefthand button once.

Opening an icon

Opening disk or folder icons lets you examine their contents; opening program (or some document) icons runs the program.

1 Move the pointer to the icon you want to open.

The icon you point to may have been selected already but it does not have to have been.

2 Double-click the lefthand mouse button.

If GEM is able to open the icon, you will briefly see an hour-glass symbol on the screen before a new screen is displayed. If you opened a disk or a folder icon, you will get a new set of icons in the window: if you opened a program or a document, you will see the screen display for the program.

If you didn't double-click fast enough, the icon merely gets selected. If this happens, try again or pull down the File menu and select **Open** (see Section 2.6).

If GEM isn't able to open the icon, it will put up a message on the screen, explaining what went wrong. The message is displayed in a box called a Dialog box.

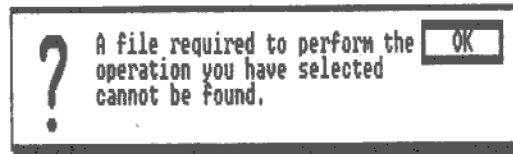

To move on to a new task, either move the pointer to the [OK] box in the Dialog box and click the mouse button or press the key.

Dragging an icon

This technique is used to copy disks, folders, programs and documents.

1 Move the pointer to the icon and hold down the lefthand mouse button.

If you like, you can click the button to select the icon before holding the button down.

2 Keep the button held down as you move the pointer to the place you want the copy stored.

The pointer will change to a hand as you start to move it.



3 Release the mouse button.

A box appears on the screen giving details of the copying process you have started. This is the 'Copy' Dialog box.

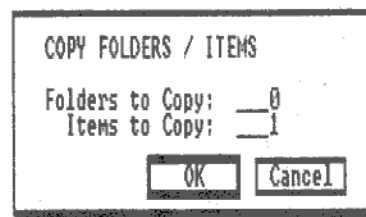

If you don't want to make this copy, move the pointer to the [Cancel] box in the Dialog box and click the mouse button once. If you do want to make this copy, click on the [OK] box. Full instructions on 'Copying files and folders' are given in Section 4.2.

2.5 About menus

The menus are lists of the possible actions you can take, grouped under a number of headings. These headings are shown in the Menu bar at the top of the screen.



When you pull down a menu on the screen (see Section 2.6 below), you see something like this:

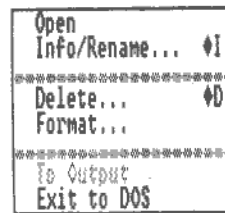

- The options shown in dark script are ones that you can take now.
- The options in light script are ones which are not available at present.
- The options followed by ... won't be carried out immediately. First a Dialog box will be displayed on the screen asking you for further details before the action is carried out.
- The combination of a diamond shape and a letter after some of the options tells you an alternative way of selecting this action (see Section 2.6 below).

The options you can choose at any time depend on what disks, folders, programs or documents are currently selected. Many of the actions are only available if you have first selected a folder, program or document icon.

When you are using the GEM Desktop, you have a particular set of menus to use. Details of these menus are given in Chapter 7. When you are running a program that uses the GEM software, the menus you have depend on the program. The program's own user guide should give you full details of these menus.

2.6 Actions with menus

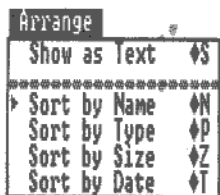

Pulling down a menu

- 1 Move the pointer to the menu bar and the name of the menu you want.

Don't worry if you pull down a different menu on the way: when the pointer is in the right place on the menu bar, the right menu will be displayed.

Selecting a different menu

- 1 Move the pointer along the menu bar to the name of the menu you now want to display.



Selecting an option from the menu

The available options are listed in dark script. Actions listed in light script are not available at present and trying to select one of these will just close up the menu.

- 1 Move the pointer up or down to the option you require.

You will see the entry in the menu become highlighted as the pointer reaches it.

- 2 Click the lefthand mouse button once.

What happens next depends on the option you selected. If the entry in the menu had ... at the end of it, a Dialog box will be displayed on the screen. (Dialog boxes are described in Section 2.9, below.)

Closing up all menus

- 1 Move the pointer to a clear area in a window.

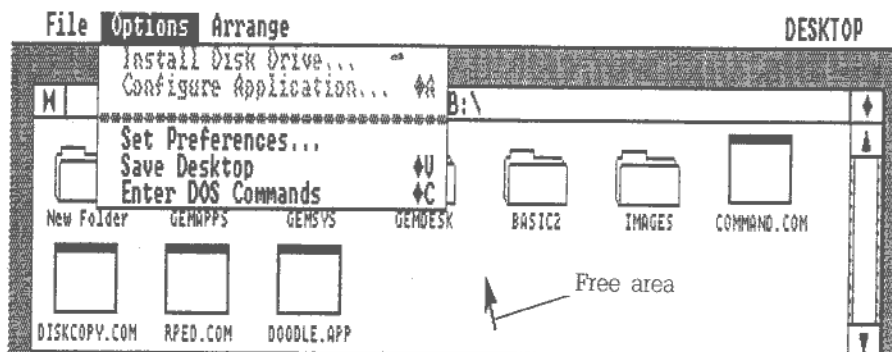

- 2 Click the lefthand mouse button once.

The alternative to using the menu

- 1 Hold down the **Alt** key and press the letter given beside the option you want in the menu.

For example, suppose you knew without pulling down the File menu that the **Delete...** option has **⌘D** beside it. Instead of pulling down the menu and clicking on the **Delete...** option, you could simply hold down the **Alt** key and press the **D** key.

Note: This method can't be used if there is a menu on the screen.

2.7 About windows

Windows are areas of the screen in which information can be displayed. They are called windows because what you see in each is part of an imaginary page (called the Virtual Screen) on which the program actually writes the information. Through some windows you can see the whole of this page of information: through others, you only see a section of it.

It is possible to have up to four different windows on your display screen at the same time and these can be either side by side or overlapping. The 'Active' window is the one that is currently being worked on: this is always on the top of your 'pile' of windows.

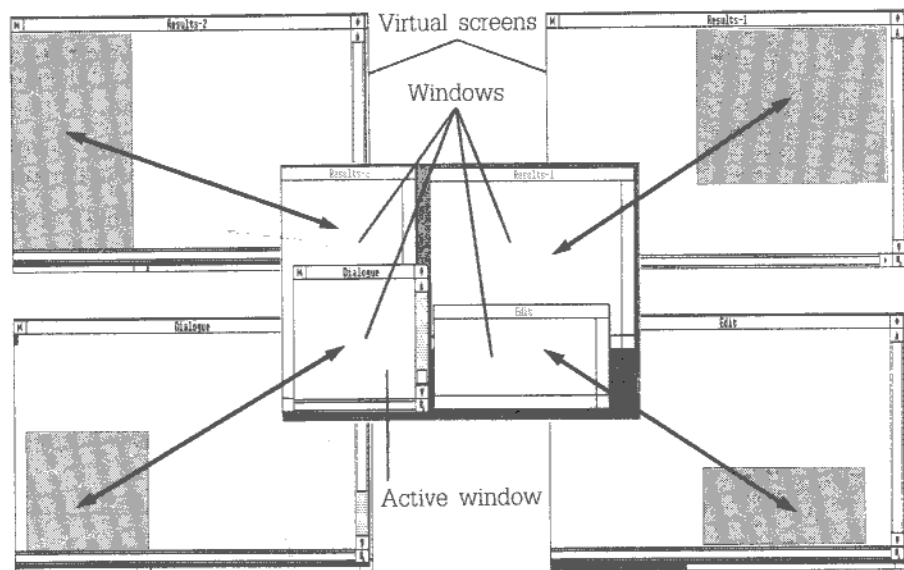

There are two main sorts of window: 'directory' windows, which display the contents of a folder on your disk, and 'application' windows, in which an aspect of the program you are running is displayed. 'Directory' windows can only ever occupy either the whole screen or half the screen, while the different sizes an 'application' window can be depend on the details of the program.

An active window has a number of components (see below). Every window has a title bar but which other components it has depends on the window. For example, directory windows don't have a size box and only have a scroll bar on their righthand border. A window which isn't active at present just has a title bar, showing its name written in light text to show that it is not being worked on.

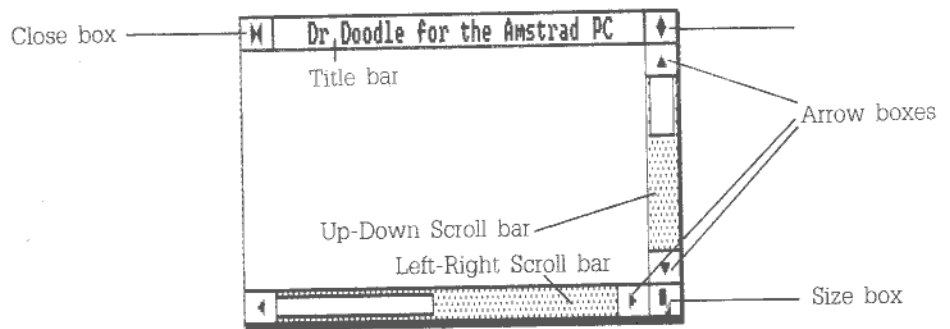

The Title Bar: The title bar records what items have been opened in order to reach the current display. In other words, it records the 'path' from the principal directory of the disk (known as the Root Directory) to this display. The last section of the title tells you what is currently displayed in the window, as follows:

- | | |
|-------------------------------------|---|
| Disk Drives | The window is displaying what disk drives your PC has |
| A:\ (or similar) | The window is displaying the Root Directory of the disk, ie. a summary of all the folders, programs and documents on the disk |
| A:...\FOLDER1\ (or similar) | The window is displaying the folders, programs and documents within one of the folders on the disk |
| A:...\PROGRAM.1 (or similar) | The window is displaying the screen for the program you are now running |

(Folders, programs and documents are explained in Part I, Chapter 1.)

When you open a folder, program or document in a directory window, you take a step further away from the Root Directory of the disk and so the path recorded in the title bar is lengthened by the name of the item you have just opened. If you close up a window, you take a step back nearer to the Root Directory and so the path is shortened by the name of the item you have just closed.

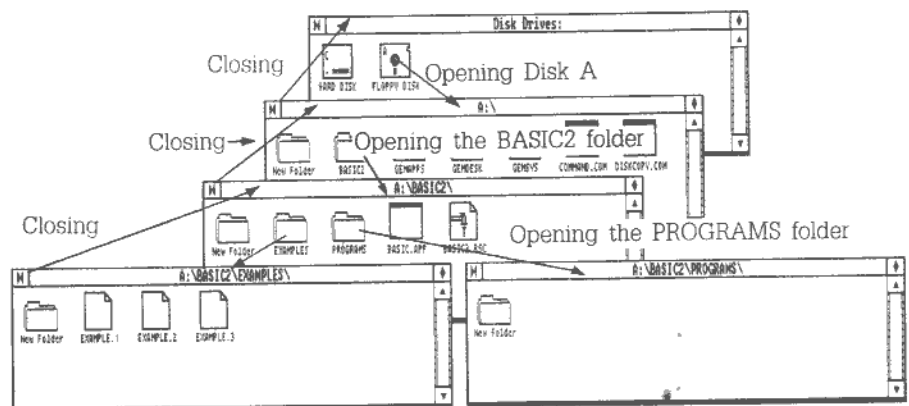

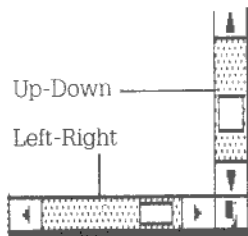

The Scroll Bars: Scroll bars are used to show you what section of the program's Virtual Screen (ie. the page the program is actually writing information on) is currently being shown in the window. The Up-Down scroll bar tells you how much of the depth of the virtual screen is being shown; the Left-Right scroll bar tells you how much of the width of the virtual screen is being shown.

The section of the virtual screen that is displayed is represented by a blank area in the scroll bar; areas of the scroll bars that are shaded represent the sections of the virtual screen that are not displayed. For example, in the Up-Down scroll bar:

- If the blank area is at the top, you are looking at the top section of the page
- If the blank area is at the bottom, you are looking at the bottom section
- If the blank area is part way up, you are looking at a section in the middle

The size of the blank section represents the proportion of the virtual screen that is being displayed in the window.

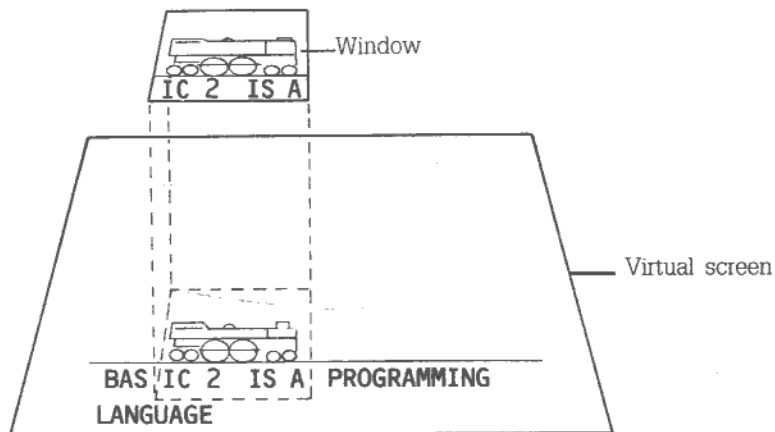

Changing the section of the virtual screen shown in the window is called 'Scrolling the window'.



The Close Box: You use a window's close box to move one step back along the path outlined in the title bar. (Note: Not all windows have a close box.)



The Full Box: The full box lets you change the area used by the window from a section of the screen to the full screen, and back again. If a window does not have a full box, its size cannot be changed in this way.



The Size Box: The size box lets you change the size of a window. If a window does not have a size box, its size cannot be changed.

2.8 Actions with windows

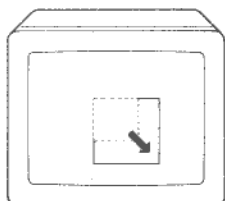

Changing the size of a window

Changing the size of a window changes the amount of the virtual screen that can be displayed in the window. It doesn't expand or shrink the contents of the current window. The maximum amount of information is displayed when the window occupies the whole screen.

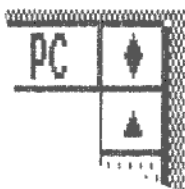

- **To make the window temporarily occupy the whole screen:**

- 1 **Move the pointer to the window's full box.**
- 2 **Click the lefthand mouse button once.**

Exactly the same steps are required to return the window to its previous size. However, be careful to click when the pointer is on the full box: if you click when the pointer is on the title bar, you make the window's 'set' size the full screen and you can no longer quickly switch back to its previous smaller size.

- **To make the window some other size:**

Note: This is only possible if the window has a size box.

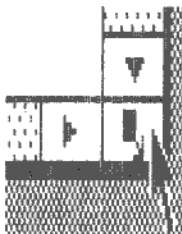

- 1 **Move the pointer to the window's size box.**
- 2 **Hold down the lefthand mouse button and move the pointer to the position you have chosen for the bottom righthand corner of the window.**

Broken lines move with the pointer marking the edges of your proposed new window.

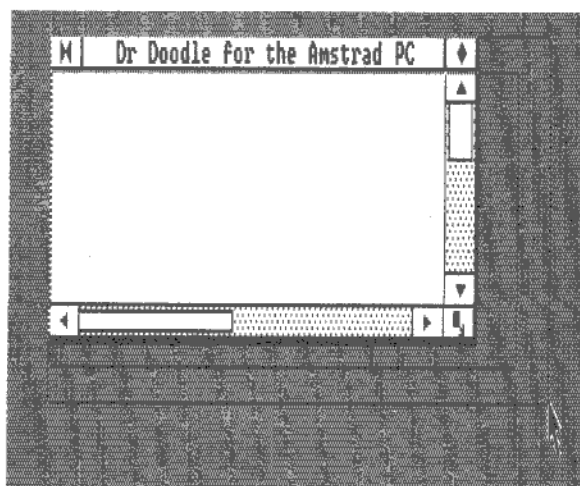

3 Release the mouse button.

The screen is now redrawn within your new window.

Note: The position of the top lefthand corner of the window remains fixed while you are changing the size of the window. To get the window size you want, you may have to move the whole window up and/or to the left first. (See 'Moving a window' below.)

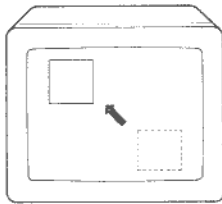

Moving a window

This moves both the window and the information it is currently showing. It does not make the window show a different section of the virtual screen on which the program is writing information: for that, you need to 'scroll' the window (see below).

Note: You cannot move directory windows.

1 Move the pointer to the title bar of the window.

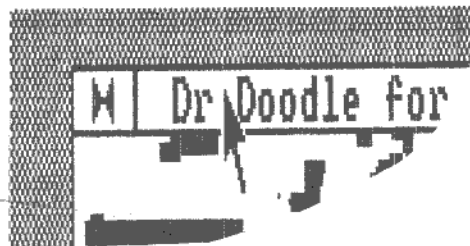

2 Hold down the lefthand mouse button and move the pointer to the position you have chosen for the title bar.

Broken lines move with the pointer marking the edges of your proposed new window.

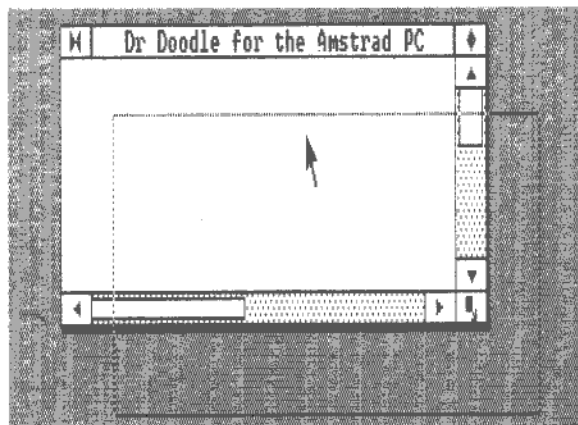

3 Release the mouse button.

The screen is now redrawn within your new window

Scrolling a window

This changes the part of the Virtual Screen shown in the window. The window itself doesn't move.

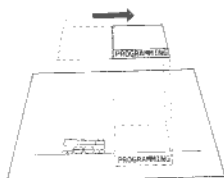

Either:

- 1 Move the pointer to the arrow box corresponding to the direction in which you want to scroll the contents of the window.

For example, if you want to see information to the right of that currently displayed, move the pointer to the right arrow box.

- 2 Click the lefthand mouse button once.

The contents of the window will move one 'unit' in the direction of the arrow. If there is text in the window, the unit is one character (height or width). If everything in the window is represented by icons, the unit is one icon. If there is no further information to be displayed, clicking on the arrow box will have no effect.

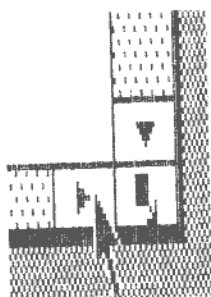

Or:

- 1 Move the pointer to the shaded area of the scroll bar corresponding to the part of the virtual screen you want displayed.

For example, if you want to see information below that currently displayed, move the pointer to the lower shaded area on the Up-Down scroll bar.

- 2 Click the lefthand mouse button once.

The contents within the window will move a full window width/depth (or to the edge of the virtual screen if this is nearer) in the appropriate direction. For example, if you clicked on the lower shaded area of the Up-Down scroll bar, you will see the next full window width below the section of the virtual screen currently being displayed.

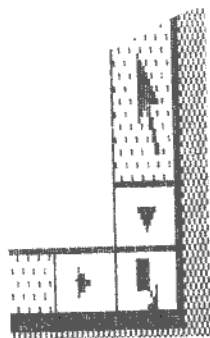

Or:

- 1 Move the pointer to the blank area within the border.

If you want to see information higher up or lower down the page, move to the blank area of the Up-Down scroll bar. If you want to see information to the right or to the left of that currently displayed, move to the blank area of the Left-Right scroll bar.

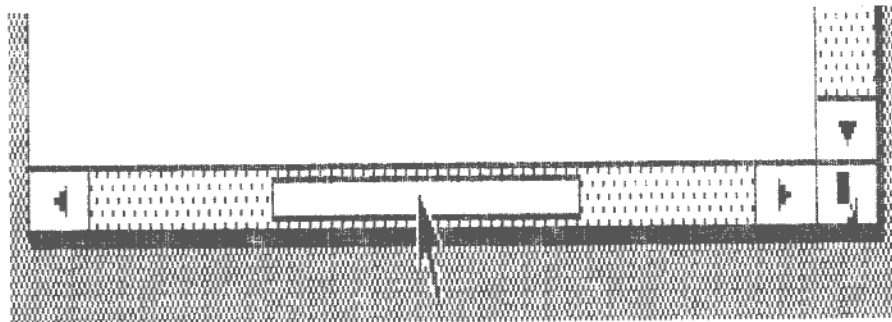

- 2 Hold down the lefthand mouse button and move the pointer to the section of the scroll bar that represents the part of the virtual screen you want to see.**

You will see an outline of the blank area of the scroll bar move with the pointer.

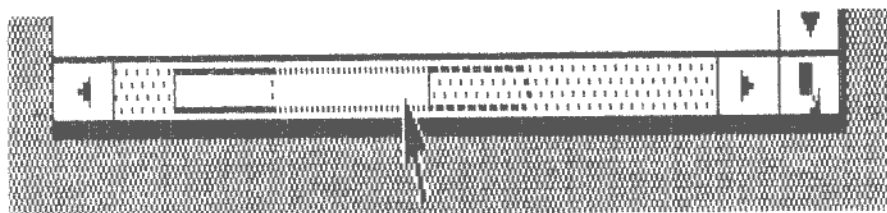

- 3 Release the button.**

The new section of the page is now displayed.

Before

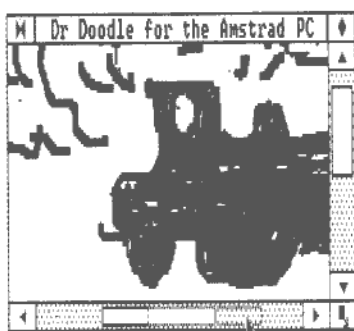

After

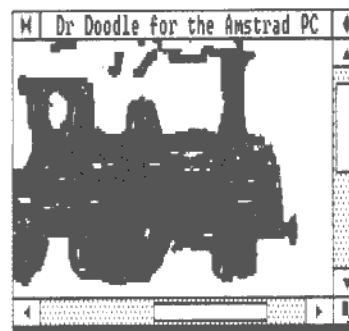

Making a different window the active window

- 1 Move the pointer to some visible part of the window you want to select.

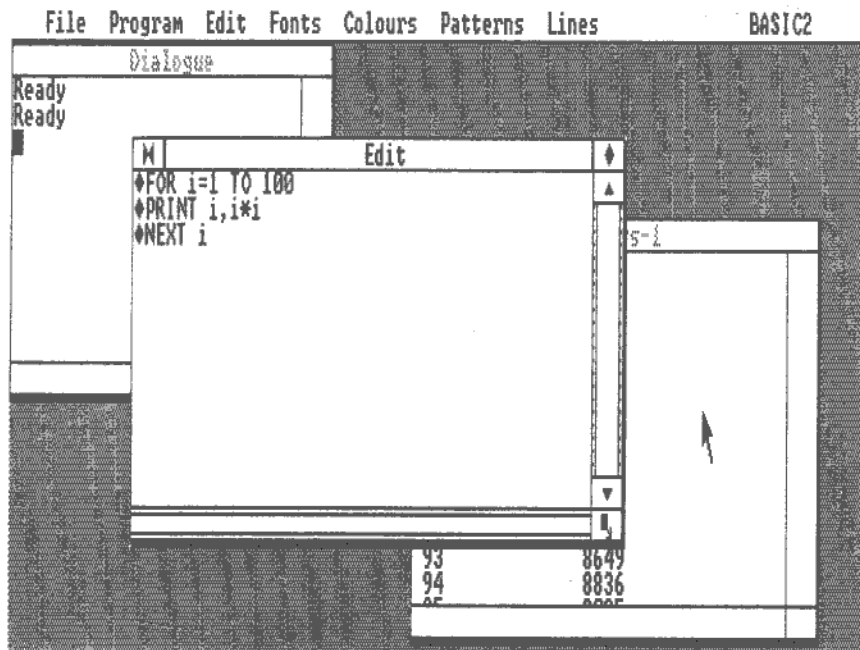

- 2 Click the lefthand mouse button once.

The window you have selected now comes to the top of the pile on your screen and its title bar is written once again in dark text. The title bar of the window you had been working on (if this is visible) is now written in light text.

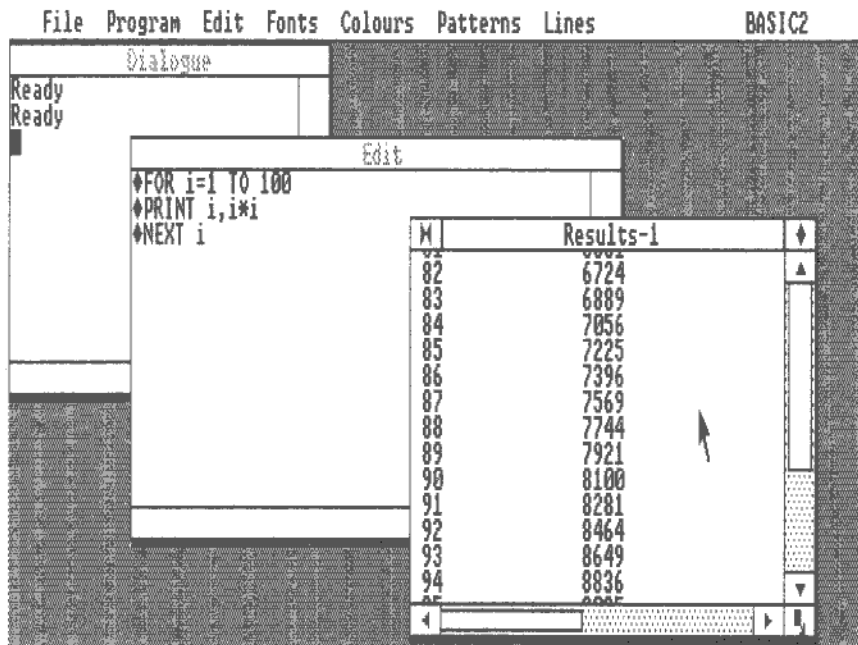

The window you had been working on is not closed. It is just put aside for a while.

Closing a window

You close a window to:

- finish working on the task in the window
- go back to showing the folder that holds the item shown on the screen

- **If the window has a close box (ie. a box with a 'bow-tie' in it in the top lefthand corner):**

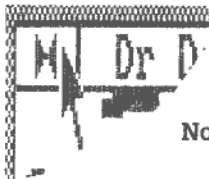

1 Move the pointer to the close box.

2 Click the lefthand mouse button once.

Note: You cannot close a window showing what disk drives your PC has.

- **If the window doesn't have a close box:**

1 Move the pointer to the title bar of the window



2 Shift-click.

To Shift-click, hold down the righthand mouse button and click the lefthand mouse button once.

Note: Many programs give you the option of leaving the program through one of the program menus. For example, Locomotive BASIC 2's File menu includes the option 'Quit'. If the program has such an option, use this to leave the program: don't try Shift-clicking on the title bar.

2.9 About Dialog boxes

When GEM needs extra information from you or needs to bring something to your notice, it displays an appropriate message in a box at the centre of the screen. This is called a Dialog box.

Some Dialog boxes only require you to read the message and then select which 'exit' option to take. Warning messages (also known as Alert boxes) are like this.

One or more exit options will be presented in separate boxes looking rather like push buttons. They will have labels such as 'OK', 'Retry' and 'Cancel'. Selecting an exit button is the only way to leave a Dialog box. One of the exit buttons may have a thicker box than the others - this is the exit button you are most likely to want, ie. the 'principal' exit button.



Other Dialog boxes require you to type in information. What you need to type and where you need to type the information should be clear from the text in the Dialog box. The places in a Dialog box where you can enter information are called Text Fields and you type information in one text field at a time. Special steps need to be taken to move to another text field. These are described below.

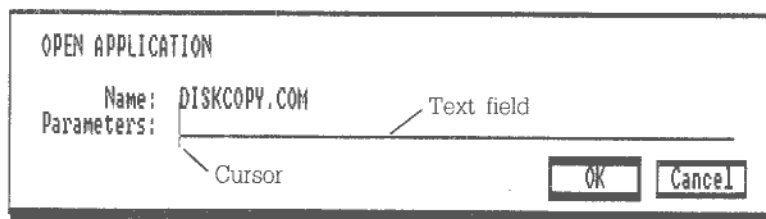

A special Dialog box, called the Item Selector Dialog box, has a window within it in which contents of folders are displayed. How to select one or more items through this Dialog box is described in Section 2.11.

2.10 Actions with Dialog boxes

Selecting a Dialog box option

- 1 Move the pointer to the option 'button'.

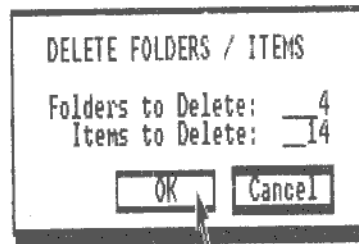

- 2 Click the lefthand mouse button once.

To select the principal (or the only) exit button:

Either: Move the pointer and click the mouse button as described above.

Or: Press the key.

Note: This manual always describes leaving particular Dialog boxes in terms of clicking on the exit button you require. If this option is either the only exit button or the principal exit button (ie. an exit button with the thicker outline), you can always press the key instead.

Entering information in Dialog boxes

You can only enter information in certain places in the Dialog box. Each of these is called a Text Field. If there are any characters which must appear in the text field, these will already be in the text field in their correct positions.

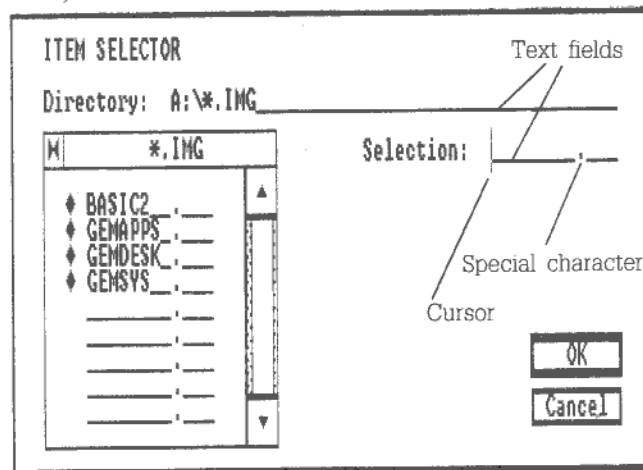

You type information into one text field at a time: this is the text field with the Dialog box cursor (|) in it. The cursor marks where the next character you type will appear.

In some cases, GEM will have already put some of the characters in the text field in the positions it wants them to have when all the information has been entered. These characters are usually either full stops or slashes. For example, where you need to type in the name of a file, you may see a full stop in the text field.



When you fill in such a text field, type the information that goes to the left of the supplied character (eg. the filename), then type the supplied character (eg. a full stop), and then type the information that goes to the right of the character (eg. the filetype). You will see the cursor jump to the right of the supplied character as you type this character.

Note: There is no need to type spaces to take the cursor up to the supplied character before typing this character.

(i) typing MYFILE;	Selection: MYFILE _._
(ii) typing full stop;	Selection: MYFILE _.
(iii) typing the T of TXT	Selection: MYFILE .T_

Moving to a different text field

● **To move to the next text field:**

1 Press either the  key or the  key on your keyboard.

● **To move to the previous text field:**

1 Press either the  key on your keyboard or hold down the  key and press the  key.

● **To move to any text field in the Dialog box:**

1 Move the pointer to this field.

2 Click the lefthand mouse button once.

Changing information in a Dialog box

Information already in a text field can be changed at any time while the Dialog box is on the screen, for example, if you made typing errors as you type the information or if you simply decide change what has been entered. Move to the text field, if you are not already working on this field, and then use the following keystrokes:



to move the cursor one place to the left



to move the cursor one place to the right



to delete the character to the right of the cursor. The remaining characters to the right of the cursor move one place left to close up the space.

<Del

to delete the characters to the left of the cursor. The cursor and the characters to the right of the cursor move one place left to close up the space.

Esc

to erase all the characters in the text field. The cursor moves to the beginning of the field.

Note: If pressing the cursor keys doesn't move the cursor, but moves the pointer instead, press the **Ctrl** key and then try again. Your PC will beep as you press the **Ctrl** key – unless you have turned the sound right down or off (see Section 8.1) – to tell you that it has changed the effect the cursor keys have.

2.11 Selecting items through the Item Selector Dialog box

If the program you are running needs you to select one or more files or folders, it will display the 'Item Selector' Dialog box. This contains within it a window in which the names of the files and folders in the folder currently open on your Desktop are displayed. This window has a title bar, giving the path to the folder displayed on the screen, and a scroll bar which you can use to scroll the list in the window if so required.

If what you are doing means that you can only use files with a particular filetype (the part of the file's name after the full stop), this filetype will be displayed on the 'Directory' line and only files with this filetype will be shown alongside the folders in the window.

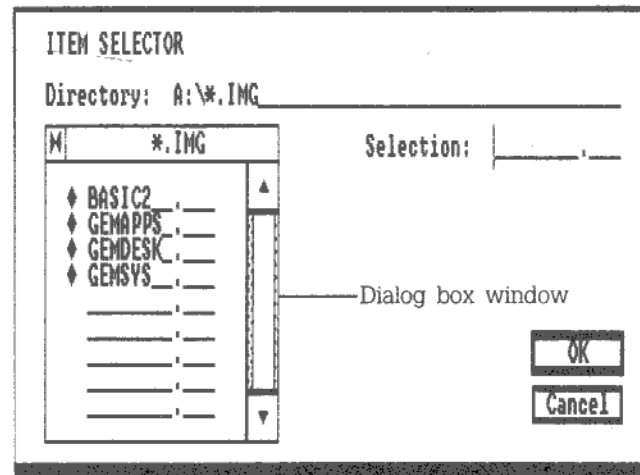

Techniques are described below for:

- changing which folder is displayed in the window
- selecting one item
- selecting a number of items

Changing which folder is displayed in the window

- **If the folder you require is on the same disk:**

- 1 Close the window and/or open folders displayed in the window until the folder you want is displayed.**

Close the window by clicking on the window's close box. Open a folder by clicking on its name. (You do not need to double-click the mouse button in this case.)

Throughout, only folders and files which match the template given on the Directory line of the Dialog box are listed in the window.

- **If the folder you require is on a different disk:**

- 1 Make sure that the disk holding the folder you require is in one of your PC's drives.**

If necessary, release the disk currently in the drive and withdraw it completely. Insert the disk you now require.

- 2 Move the pointer to the line of the Dialog box starting 'Directory' and click the lefthand mouse button once.**

- 3 Press the Esc key.**

This erases the file details currently entered on this line of the Dialog box.

If you know full details of the folder you want:

- 4 Type the drive letter of the disk you require followed by a colon, a backslash and the appropriate 'template' for the files you want.**

The template you will need is the path from the Root Directory to the folder (ie. a list of all the folders that need to be opened in order to display the files you want) and a file name template, separated by a backslash. (How to construct a file name template is described in Part I, Section 8.5.)

For example, if you want to move over to using the \BUSINESSLETTERS directory on Drive C but you don't have any special requirements about the files you want to select, you should type **C:\BUSINESS\LETTERS*.*** (The template *.* matches every file in a directory.) However, if you wanted only files with the filetype GEM, you would type **C:\BUSINESS\LETTERS*.GEM**

- 5 Move the pointer to the title bar of the directory window of the Dialog box and click the lefthand mouse button once.**

The folder you require should now be displayed on the screen.

If you don't know precisely which folder you want:

- 4 Type the drive letter of the disk you require followed by a colon and the appropriate file name template.**

For example, if you want to use files on Drive C and you don't have any special requirements about the files you want to select, you would type **C:*.***. However, if you only wanted files with the filetype GEM, you should type **C:*.GEM**. (How to construct a file name template is described in Part I, Section 8.5.)

- 5 Move the pointer to the title bar of the directory window of the Dialog box and click the lefthand mouse button once.**

This changes the folder displayed to the Root Directory of the disk you have selected.

- 6 Close the window and/or open folders displayed in the window until the folder you want is displayed.**

Close the window by clicking on the window's close box. Open a folder by clicking on its name. (You do not need to double-click the mouse button in this case.)

Throughout only folders and files which match the template given on the Directory line of the Dialog box are listed in the window.

Making your selection

To select one of the files displayed in the Dialog box window:

Either:

- 1 Double-click on the name of the file in the directory window within the Dialog box.**

Or:

- 1 Click on the name of the file in the directory window within the Dialog box.**
- 2 Click on the [OK] exit button.**

Or:

- 1 Type in the name of the item you want beside the label 'Selection'.**

How to enter information in a Dialog box is described in Section 2.10.

- 2 Click on the [OK] exit button.**

To select a number of files displayed in the window:

- 1 Select the items you want by Shift-clicking on their names.**

The technique of Shift-clicking is described in Section 2.2.

- 2 Click on the [OK] exit button.**

To select all the files in the folder that match the template:

- 1 Check that no items are selected in the directory window and that the text area beside the label 'Selection' is blank.**

Clear any selected items by clicking on a clear area of the Dialog box. Clear any 'selection' by clicking on this text area and pressing the **Esc** key.

- 2 Click on the [OK] exit button.**

2.12 Changing to using a different disk

To start looking at the directories on a different disk, you need both to replace the disk in the drive with the new disk and 'log in' the new disk. The steps to take are as follows:

1 Release the disk in the drive.

For instructions, see Chapter 4 'About disks' in Part I of this manual.

2 Insert the disk you want to replace it by.

3 Press the **Esc** key.

What is displayed after the new disk is logged in depends on the path to the folder displayed in the title bar immediately before you changed disks and on how this compares with the paths available on the new disk. In deciding which folder to display, GEM will follow as much of the previous path as possible. If there is no common path, the window will show the Root Directory of the new disk.

For example, suppose the previous title bar showed **A:\BUSINESS\LETTERS**. If your new disk has a folder in the Root directory called **BUSINESS**, but this folder doesn't contain a folder called **LETTERS**, the title bar will show **A:\BUSINESS**. If the disk doesn't have a folder called **BUSINESS** in the Root directory, the title bar will show **A:**.

2.13 Moving over to using DOS commands

When you want to use facilities described in Part III of this manual, you will have to leave the GEM Desktop. You will either want to:

- leave GEM temporarily, so that you can use a particular DOS command or set of commands
- or move fully into using DOS, for example so that you can run a particular suite of programs

The actions you take in the two cases are different.

Leaving GEM temporarily

Note: This method leaves the GEM software in your PC's memory - reducing the amount of memory available for the work you do using DOS command lines. If you want to do anything more than using DOS commands and running small programs, you should move over to using DOS completely.

To leave GEM Desktop:

Either:



1 Move the pointer to the Menu bar and pull down the Options menu.

How to do this is described in Section 2.6.

2 Select 'Enter DOS commands'

Move the pointer to this option and click the lefthand mouse button when 'Enter DOS commands' is highlighted.

Or: Hold down the Alt key and press [C]

In either case, if you have a floppy disk system and you don't have a copy of Disk 1 of your AMSTRAD PC disks in Drive A, you may see a Dialog box on the screen.

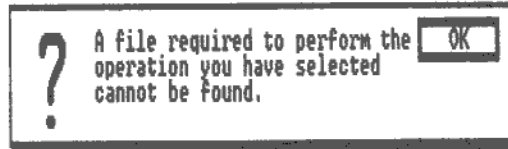

If this appears, click on the [OK] exit button (or press ↵) and then insert in Drive A a copy of Disk 1 or any other disk you have that holds a copy of the MS-DOS 3.2 COMMAND.COM program. Now go through the stages of leaving the Desktop again.

The PC should clear the screen and display a C> or A> system prompt. This tells you that you can now use DOS commands, as described in Part III of this manual.

```
Microsoft(R) MS-DOS(R) Version 3.20
(C)Copyright Microsoft Corp 1981-1986
```

```
C>
```

To return to using GEM Desktop:

1 Put your Desktop disk (Disk 3) in Drive A.

Note: In the case of a Hard Disk PC no changing of disks is required, just type EXIT ↵

2 Type:

```
EXIT  ↵
```

```
Microsoft(R) MS-DOS(R) Version 3.20
(C)Copyright Microsoft Corp 1981-1986
```

```
C>path
PATH=A:\BASIC2;A:\GEMDESK;A:\GEMAPPS;A:\GEMSYS;A:\
C>exit
```

This puts you back using the GEM Desktop.

Moving over to use DOS completely

To leave GEM Desktop:

Note: This procedure removes the GEM software from your PC's memory.

1 Move the pointer to the Menu bar and pull down the File menu.

How to do this is described in Section 2.6.

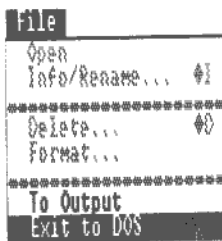

2 Select 'Exit to DOS'.

Move the pointer to this option and click the lefthand mouse button when 'Exit to DOS' is highlighted.

If you have a floppy disk system and don't have any disk in Drive A (the lefthand floppy disk drive, if you have two), you will see the message:

Abort or Retry:

Insert your GEM Startup Disk (Disk 2) in Drive A and type R

If you don't have the GEM Startup disk (Disk 2) in Drive A, you may now see the message:

Insert diskette with batch file
and press any key when ready

Either insert Disk 2 in Drive A and then press either a character key or , or hold down the key and press ; then type Y to the question:

Terminate batch job (Y/N)?

The PC clears the screen and displays a C> or A> system prompt. This tells you that you can now use DOS commands (as described in Part III of this manual).

To return to using GEM Desktop:

Either:

1 Insert a copy of Disk 2 of your AMSTRAD PC disks in Drive A.

Type the commands:

```
A:   
CD \   
GEM 
```

Or:

2 Insert a copy of Disk 1 in drive A.

Reset your PC by holding down both and and pressing .

Type the command GEM and follow the instructions on the screen.

These are the same instructions as you see when you first load the system software into your PC.

The GEM software is now reloaded into your PC's memory.

Note: In the case of a Hard Disk PC no changing of disks is required just type GEM

3. RUNNING PROGRAMS UNDER GEM

This chapter describes the steps involved in running programs on your AMSTRAD PC from the GEM Desktop. These programs will often be GEM-based – ie. designed to make use of the GEM software's system of a pointer and menus – but other programs can be run as well.

All the DOS-style programs (ie. with the filetype .COM or .EXE) supplied with your AMSTRAD PC and many of the most popular commercial programs will already be fully set up for running under GEM. To use one of these programs, you just need to follow the instructions given below in Section 3.3 or the step-by-step instructions given in Part 1, Section 5.3.

Other programs will need some preparation. If the program has not been set up to run on the AMSTRAD PC, it may need to be 'installed' (your dealer will be able to tell you if this is the case). If it has been set up for the AMSTRAD PC but not to run under GEM, it may need to be 'configured' to make it especially easy to run from the GEM Desktop.

'Configuring' a program to run under GEM stores information about the program in the GEM Desktop. This information is the filetype of the data files associated with it and the additional information ('parameters') needed before the program can run. It also lets you select the icon pictures used on the program and data files.

Programs don't need to be configured before they can be run from the GEM Desktop but configuring has certain advantages:

- in most cases, a configured program will run immediately after you open its icon, whereas unconfigured programs require you to go through an intermediate step
- in many cases, a configured program can be run by just opening the associated document you want to work on – again saving you from going through an intermediate step

You can often tell if a program has been configured by looking at its icon. If this has a picture on it, then the program has certainly been configured. If there is no picture on the icon, assume to start with that the program has not been configured.

Configuring a program is easy to do but newcomers to computing are advised to avoid programs that need **installation** until they are familiar with using the AMSTRAD PC.

Installing a program, configuring a program and running a program from the GEM Desktop are each described below.

Before you use any program for the first time, do read the introductory sections of its user guide. These should tell you whether you will need to have disks ready to store data files, which disks you put in which drive while running the program, the name(s) of the program file(s), which directory they are stored in and much other important information.

- Note:** (i) Always remember to check out whether you can make a duplicate copy of the programs you buy before using them. If possible, you should always use a copy and keep the original disks safely stored away, for use solely to make further copies as and when these are needed.

- (ii) There is advice in Appendix I on how to prepare disks holding only the programs and external commands you need while you are using a particular application (for example, your word processor or your spreadsheet).

3.1 Installing a program

Note: The instructions given should only be followed if the program comes with a well-documented installation program. In particular, if there isn't an installation program, don't try to install the program without the help of someone who is knowledgeable about the program – for example, your dealer.

1 Find out details of the installation procedure from the program's own user guide.

In particular, find out the name of the installation program, which disk this is on (if the software is on more than one disk) and in which directory.

2 Place the disk(s) specified in the program's user guide in your disk drive(s) and press the **[Esc] key.**

This shows the contents of the disk(s) in the Desktop windows.

3 Run the installation program by double-clicking on its icon.

4 Follow the instructions in the program's user guide.

Take special care to follow the instructions about inserting and replacing disks.

The information about the AMSTRAD PC that the installation program may need you to supply while you are running this program is given in Appendix IV.

Note: (i) When an installation program asks to identify the type of display or screen your PC has from a list, you should select Colour (Color) or Colour Graphics if you have a PC CD or ECD and you should select Monochrome or Hercules if you have a PC MD. Always refer to Appendix I if the software mentions the AMSTRAD PC1512.

(ii) Some installation procedures end by giving you the option of starting to use the program immediately or going back to the GEM Desktop.

3.2 Configuring a program

1 Place the disk holding the program in Drive A and press the **[Esc] key.**

2 Move the pointer to the program's icon and click the lefthand mouse button once.

The icon should be re-drawn with a heavier outline. If it isn't, try again.

3 Pull down the Options menu and select 'Configure Application...'. Alternatively, hold down the **[Alt] key and press **[A]**.**

How to pull down a menu and select an option is described in Section 2.6.

The following Dialog box should appear on the screen.

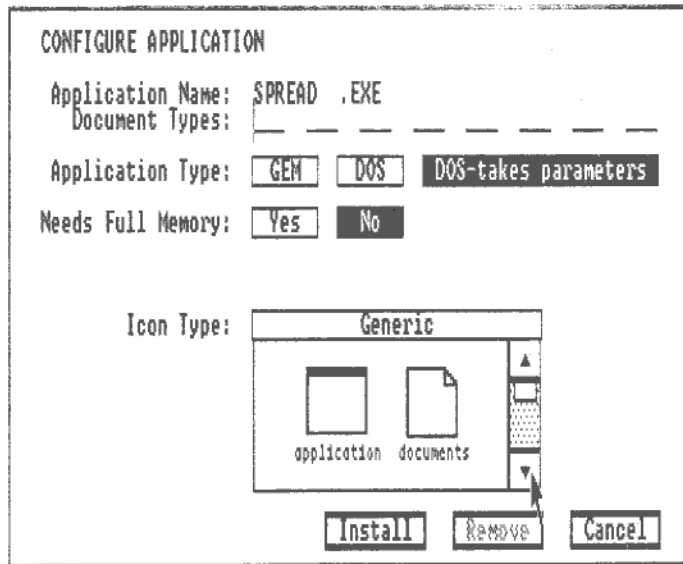

4 Check whether the [Remove] exit button on the bottom line of the Dialog box is in light text or normal text.

If this option is in normal text, the program has already been configured to run under GEM. Click on the [Cancel] exit button unless there are any details you want to change – you don't need to follow these instructions any further.

5 Look at the program's user guide and see if this says that the program's data files have a particular filetype.

A file's filetype is the second part of its file name (after the full stop). The user guide may give more than one filetype, if more than one sort of data file is produced. If the guide doesn't give any filetype, decide on a filetype that isn't used for any of your other files and make a mental note to always use this filetype for these data files.

Up to eight different filetypes can be associated with one program.

6 Type in these filetypes.

The cursor is automatically positioned ready for you to type the first filetype. Press either the key or the key to move to the slot for the next filetype. Check each filetype as you type it. If you make a mistake, press the key to rub out characters and type these in again.

7 Select the 'Application Type' for the program, by moving the pointer to the option you require and clicking the lefthand mouse button once.

Select 'GEM' if the program makes use of the GEM software – ie. features menus, pointers etc. Otherwise, look in the program's user guide and see what 'command line' this says you have to type in order to run the program. If, for example, your program is SPREAD.COM and the user guide tells you to just type SPREAD (ie. the program's name) to run the program, choose 'DOS'. If, however, it tells you to type something like SPREAD SOURCE.DAT YOUR.DAT or even just SPREAD SOURCE.DAT, choose 'DOS takes parameters'.

- 8 Click on the 'Yes' option on the 'Needs Full Memory' line of the Dialog box if the program will require as much memory as possible when it is run.**

If you don't know how much memory your program will require, leave it without full memory. If the program fails with a message like 'Not enough memory to run' or you can't work on as big a spreadsheet as you would like, you can always reconfigure the program to use full memory.

You should only need the 'Yes' option for programs like spreadsheets that use a large amount of memory. Note: after using such a program, you will have to reload the GEM software.

- 9 Select the pair of icon pictures to be used for the program and its associated data files.**

Scroll through the options in the 'Icon Type' window by clicking on the up arrow or the down arrow box until the pair of pictures you want is displayed. For example, if you have a program that helps you keep your address book up to date, you might decide to give this the 'Database' icon type. This will put a picture of a filing cabinet on the program's icon and pictures of open filing cabinet drawers on all the documents it generates. What all the pictures are supposed to represent is explained in Section 2.3.

- 10 Move the pointer to the [Install] exit button and click the mouse button once.**

- 11 Replace the disk in Drive A by your Desktop disk and press [Esc]. (With a Hard Disk PC no changing of disks is required as the Desktop is already installed on the Hard Disk.)**

The next step is to save the Desktop. This stores the information you have set up for future use. However, it will also save other aspects of your current work - for example, which directories are shown. So before you save the Desktop, refer to Chapter 8 where full details are given.

- 12 Pull down the Options menu and select 'Save the Desktop'. Alternatively, hold down the [Alt] key and press [V]**

Note: The information about this program is saved as part of your GEM Desktop and it takes up memory space. If you no longer intend to use a particular program, you should remove the configuration information from the Desktop. The steps to take are:

- (i) Select the program icon.
- (ii) Pull down the Options menu and select 'Configure Application...
- (iii) Select the 'Remove' exit button from the Dialog box that appears on the screen.
- (iv) Save the Desktop (following the instructions given in Section 8.2).

3.3 Running a program

To run a program that works with the GEM software

A program that works with the GEM software has the filetype APP.

- 1 Insert the disk holding the program in Drive A (the lefthand disk drive, if you have two).**
- 2 If there is a separate data disk and you have a two-drive PC, insert this disk in Drive B (the righthand disk drive).**

3 Press [Esc]

4 Open (ie. double-click on) either the program's icon or the icon of one of the documents associated with the program.

Opening the document will automatically open the associated program, provided:

- the program has been configured (see above)
- the document has the filetype specified when the program was configured.
- the program file is either in the same directory as the document or in a directory that is automatically searched for program files. (Setting up directories for automatic search is described in Part III, Section 4.2.)

Note: If these conditions aren't met, a Dialog box like the following will appear on the screen, to tell you in effect that you can't run the program by opening this particular document.

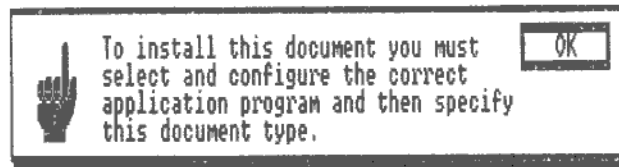

- Notes:**
- (i) While the program is running, you can swap the program disk in Drive A for the disk holding the data you want to process. If a message later appears telling you that the file you want to use can't be found, insert your program disk and press . If you are asked for COMMAND.COM, insert your MS-DOS disk.
 - (ii) The way the AMSTRAD PC is prepared prior to running GEM software may not suit all GEM programs. You may need to change the Batch files GEM.BAT and GEM3.BAT. The program's own user guide should give guidance on what is required. If in doubt, consult your dealer.

Note: The GEM program should contain its own instructions for installation onto your Hard Disk. It may also be run in the floppy disk drive. The GEM startup file on your Hard Disk system is called GEM.BAT and differs from the batch files used on a floppy disk computer.

To run a DOS program or Batch file

A DOS program will have the filetype COM or EXE; a Batch file will have the filetype BAT.

1 Insert the disk holding the program in Drive A (the lefthand disk drive, if you have two).

2 If there is a separate data disk and you have a two-drive PC, insert this disk in Drive B (the righthand disk drive).

3 Press [Esc]

4 Open (ie. double-click on) the program's icon (or click once and then select Open from the File menu).

If the program requires further information ('parameters') before it can run or it hasn't been configured to run from the Desktop, a Dialog box will appear on the screen.

Look in the program's user guide and see what 'command line' this says you have to type in order to run the program. What you need to type is the Command tail - ie. everything after the first blank space in the command line. For example, if your program is SPREAD.COM, the user guide might tell you to type something like:

SPREAD SOURCE.DAT YOUR.DAT

to run your program. What you should type in this Dialog box is:

SOURCE.DAT YOUR.DAT

If, however, the user guide tells you to just type **SPREAD**, don't type anything.

Leave the Dialog box by clicking the [OK] exit button. The program will then run.

Note: If the program requires a single parameter - a name of a document file, you can run the program by opening this document file. However, the same conditions apply as applied to GEM-based programs (see above).

If you have a Hard Disk PC:

Note that the DOS program should contain its own instructions for installation onto your Hard Disk. Some programs that incorporate sophisticated copy-protection may not be (easily) transferable to Hard Disk. DOS programs may also be run in the floppy disk drive.

3.4 Returning to the GEM Desktop after running a program

When the program you have run from the GEM Desktop finishes or you leave it in its prescribed manner, your PC will attempt to return you to using the GEM Desktop. The details are as follows:

If your program hasn't been configured to take your PC's full memory and you have a floppy disk system, you will see a Dialog box on the screen asking you to insert your Desktop disk. Place this disk (Disk 3) in Drive A (the lefthand drive if you have two), turn the drive handle across the drive slot to hold the disk in the drive and then press . You will then be returned to the Desktop.

If your program was configured to take full memory and you have a floppy disk system, you will see the message:

**Insert your GEM Startup Disk
Press any key to continue**

Place your Startup disk (Disk 2) in Drive A and then press any character key or the key. After a while, you will see a Dialog box asking you to put your Desktop disk in Drive A.

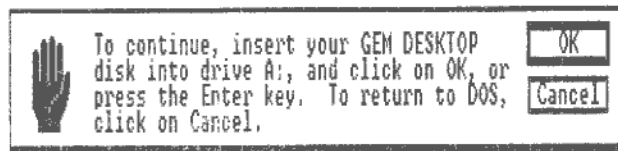

4. ORGANISING YOUR WORK:

1. ORGANISING FILES

There is nothing wrong with putting all your files into the Root directory of the disk you store them on but you can make them much more manageable by putting them into folders, rather like the folders you have in a filing cabinet. Groups of these folders can then be put into other folders alongside other files. These folders can themselves be grouped into further folders, and so on.

Trying to picture all these folders and what is in them might seem difficult. In fact the whole structure is just a sort of 'family tree', at the top of which is the 'root' of the family.

For example, suppose all your files were either to do with Home (letters to friends, games programs, etc.) or with Business (business letters, reports, accounts, etc.). Then the first step might be to have one folder for Home and one for Business. This 'tree' would be:

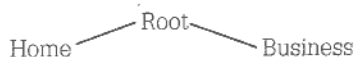

with Root as the 'parent' of Home and Business, or alternatively, Home and Business as the 'daughters' of Root.

As the numbers of files increase and the Business folder starts getting hard to search through, you may well decide to regroup your Business files into 'Letters', 'Reports' and 'Accounts'. If you did group your files in this way, your tree would look like this:



Next you might want to divide your 'Home' files into 'Letters' and 'Games'. (You don't need to find a different name for 'Letters' because these letters don't have the same parent as 'Business Letters'. Daughters of the same parent, however, do have to have different names.) Now the tree becomes:

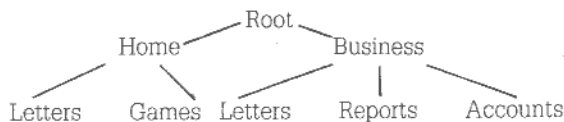

As time went on, you might then want to divide your Business letters into letters to Company 'A', Company 'B' and Company 'C' and your accounts files into those for Companies 'A', 'B' and 'C' as well. (Once again, you can use the same names for these folders because they have different parents.) The tree now becomes:

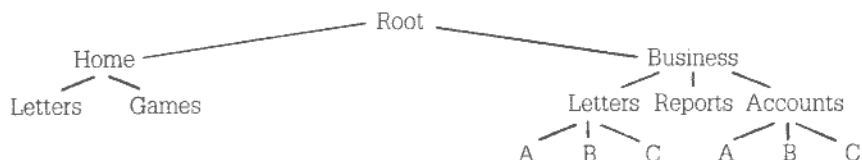

You could go on adding to this tree by dividing the contents of existing folders into two or more new folders, though you are unlikely to want anything much more complicated than this example.

4.1.1 How GEM shows your files and folders

The way GEM displays what you have stored on a disk is by showing you the contents of any folder you open - that is, the directory of the folder you choose.

When you start working on a particular disk, the first directory you see is normally the Root directory. In our example here, this would show three folders: the two we know about (one called 'Home', one called 'Business') and an extra one called 'New Folder'. The New Folder is standing by for when you want to add another folder to the Root directory.

You then have the opportunity to open either the 'Home' or the 'Business' folder and see what is stored there. (Again there will be a New Folder standing by for when you want to add another folder to this folder.) And so on.

Opening folders takes you on a path 'down' the tree - that is, away from the root. Closing the window in which a folder is displayed takes you back 'up' the tree - that is, towards the root.

If you want to move from one particular folder to another, your path will be a combination of moves up and down the tree. For example, to move from the 'Reports' folder to the 'Games' folder on the tree, you need to move:

- up to 'Business' (close the window)
- up to the Root (close the window)
- down to 'Home' (open the 'Home' folder)
- down to 'Games' (open the 'Games' folder)

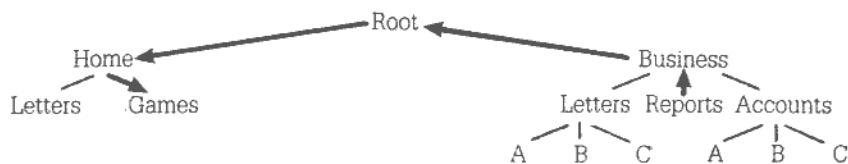

The default way for GEM to display the contents of a folder is as a series of folder, program and document icons, starting with all the folders.

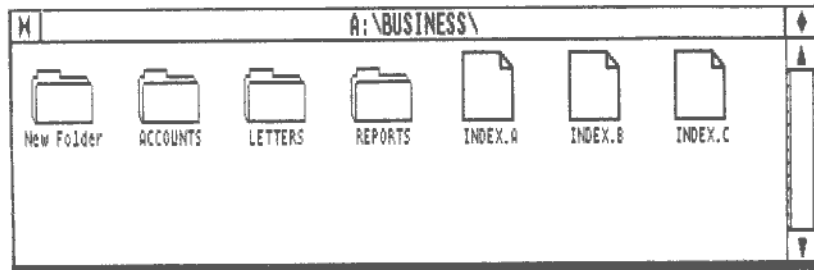

Showing the directory as a set of icons gives you a quick way of spotting similar or related files in a directory: you will remember how the picture within an icon is used to show what type of program or what type of document a file is.

This is not the only way of displaying a directory. The other option is to display it as a list of folder and file names. This is known as 'Showing as text' and is described in the next section. Directories shown as text only have the names of the items to remind you what is stored in a particular file or folder, but they also contain information about the sizes of files and the dates they were last changed.

Displaying the directory as text

Showing the directory as text gives you a list of all the files and folders in the directory, with the folders picked out by a diamond to the left of each name. The only indication of the type of information in a file is its name. However, the size of each file and the date it was last changed are also given.

		A:\BUSINESS\	
◆	New Folder		00-00-80 00:00
◆	ACCOUNTS		17-12-86 10:38
◆	LETTERS		17-12-86 10:34
◆	REPORTS		17-12-86 10:34
	INDEX A	3166	24-02-86 10:58
	INDEX B	1280	06-04-86 13:07
	INDEX C	1280	06-04-86 13:07

You can do all the operations on the folders and files when these are shown as text that you can when they are shown as icons. Just move the pointer to the line displaying the information about the folder or file and select it or open it as before.

Note: Changing the way the directory is shown affects both windows in which directories are displayed.

Changing from listing as icons to listing as text (and vice versa):

Either:

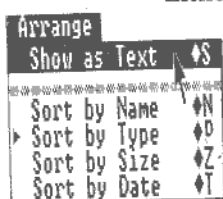

- 1 Pull down the **Arrange** menu.
- 2 Select the first entry in the menu.

If the directory is shown as icons at present, this option will be 'Show as text'; if it is shown as text, this option will be 'Show as icons'.

How to do these actions is described in Section 2.6.

Or: Hold down the **Alt** key and press **S**

Note: If you change how the directory is displayed after you select any of the directory items, you will have to reselect the items you want after the directory has been displayed in the different style.

4.1.2 Ways of sorting the directory

Immediately after loading GEM Desktop, any directory you display is typically listed in alphabetical order of name, starting with all the folders in the directory and then listing all the programs and documents.

This is not the only order in which the contents of a folder can be listed. The full list is:

- **'Sorted by name'** ie. listed in alphabetical order of name
- **'Sorted by type'** ie. listed in alphabetical order of the type part of the folder or file name
- **'Sorted by size'** ie. listed in size order, starting with the largest (Note: this only affects files; it doesn't affect the order folders are listed in)
- **'Sorted by date'** ie. listed in date order, starting with the most recently created or changed file or folder

Note: All the folders are always listed before any programs and documents, whatever option you choose.

Changing the order in which folders and files are listed:

Either:

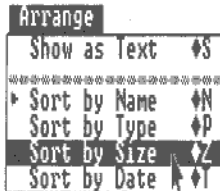

1 Pull down the Arrange menu

The arrow head beside one of the options picks out the way folders and files are ordered at present.

2 Select one of the other three ordering options in the bottom section of the menu.

How to do these actions is described in Section 2.6.

Or: Hold down the [Alt] key and press the character key corresponding to the letter shown on the same line of the menu as the option.

For 'Sort by name' press [N]; for 'Sort by type' press [P]; for 'Sort by size' press [Z]; for 'Sort by date' press [I]

Any directory shown on the screen will now be redisplayed with the folders and files listed in the order you have selected. Any other directories you display before you either reset your PC or change the order again will also be shown in this order.

Note: If you change how the directory is displayed after you select any of the directory items, you will have to re-select the items you want after the directory has been displayed in the different style.

4.1.3 Finding out what is stored in a folder

1 Display the folder in one of your two screen windows.

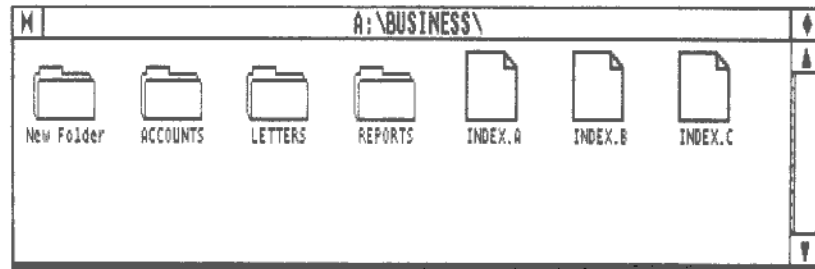

If you don't just want information about the folder currently displayed in the window, you will need to move sequentially through the folders on your disk until the right one is displayed. This will involve a combination of:

- (i) Clicking the mouse button when the pointer is on the close box to move you back to the previous folder.

4.1.4 Getting brief information about a folder, program or document

1 Select the item you want information about

Either:

2 Pull down the File menu

3 Select 'Info/Rename...' from this menu

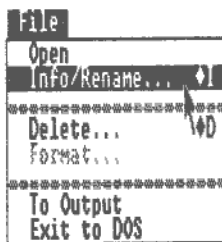

How to do these actions is described in Section 2.6.

Or:

2 Hold down the **[Alt]** key and press **[I]**

Your PC then puts a Dialog box on the screen containing brief details of the item you have selected.

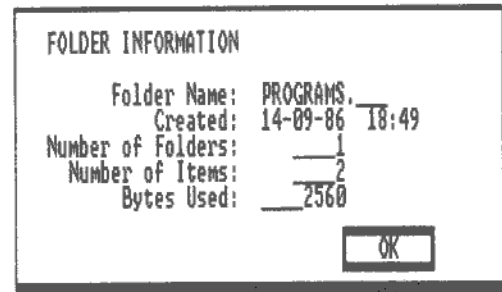
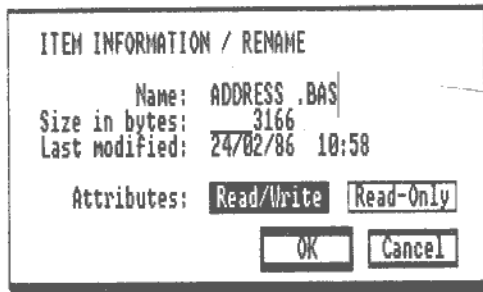

These details are:

- its full name
- when it was last modified (when it was created if it hasn't been modified)
- its size in bytes (approximately equal to the number of characters it contains)
- if it is a folder, how many folders and files it contains
- if it is a file, whether it is Read-Write or Read-Only (see Section 4.2.6)

Note: If you ask for information about 'New Folder', AMSTRAD PC displays a special Dialog box with information on how to create a new folder.

When you have finished reading the information in the Dialog box, move the pointer to the **[OK]** exit button and click the lefthand mouse button.

4.1.5 Finding out how much unused storage space there is on a disk

- 1 Decide which window to use to display your PC's Disk Drives.
- 2 Move the pointer to this window's Close Box (the box in the corner with a 'bow-tie' in it) and click the lefthand button on the mouse until the window displays your PC's Disk Drives.

Note: You cannot 'overshoot' because this particular display cannot be closed by clicking on its Close Box.

- 3 Insert the disk you want to examine in Drive A.
- 4 Move the pointer to the icon representing the disk you want information on and click the lefthand button on the mouse once.
- 5 Bring the File menu onto the screen and select 'Info/Rename...'

How to do these actions is described in Section 2.6.

Your PC then puts a Dialog box on the screen containing brief details of the disk you have selected, including the amount of free space on the disk measured in bytes. (1000 bytes holds about 1000 characters.)

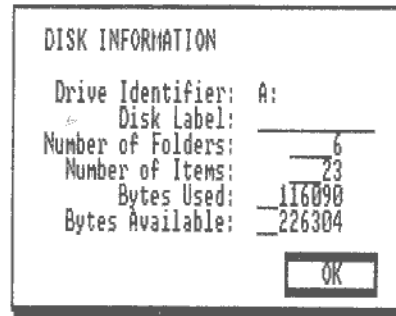

When you have finished reading the information in the Dialog box, move the pointer to the [OK] exit button and click the lefthand mouse button.

4. ORGANISING YOUR WORK: 2. DISK HOUSEKEEPING

Disk housekeeping is about keeping your disks organised, with your files on the 'right' disks and in the 'right' folders. This involves:

- creating new files
- creating new folders
- making copies of existing files and folders
- deleting files and folders you no longer want
- giving files new names
- protecting your important files against accidental deletion

It isn't possible simply to move a file or folder from one folder or disk to another. You have to make a copy in the new location and then delete the original file or folder.

The time to organise your disks is either first thing after loading the GEM software or after you have finished running one program and before you run the next.

The GEM Desktop is used for all of these operations except creating new files. Most new files are created by the programs you run but occasionally you will need to prepare a short text file. We suggest that you use the AMSTRAD PC's Text Editor, RPED, to do this — though in fact you can use any text editor. Using RPED is described in Part I, Section 6.8.

4.2.1 Creating a new folder

- 1 Display the directory you want to put the new folder in.

See Section 4.3 for details on how to do this.

- 2 Move the pointer to the New Folder icon in the window.

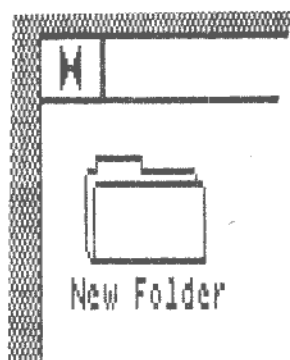

There is a New Folder icon at the beginning of every directory.

3 Double-click the mouse button.

The 'New Folder' Dialog box is then displayed.

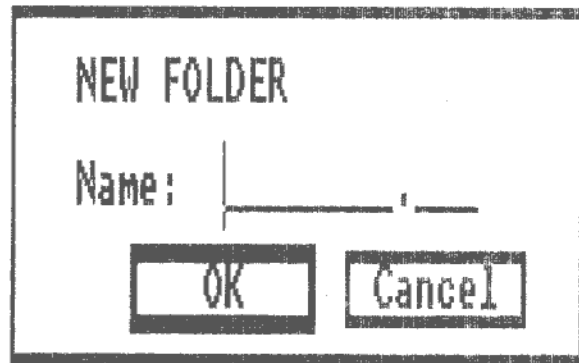

4 Enter the name you want the folder to have in the space provided in the Dialog box.

This folder name has two parts: a 'name' of up to eight characters and an optional 'type' of up to three characters, separated from the name by a full stop. The folder name you choose should:

- be different from any other folder name in this directory
- remind you of what the folder will be used to store

The usual characters to use in the folder name are the letters A...Z and the numbers 0...9, but you can use some other characters as well (see Part I, Section 8.6). You can very easily discover whether the character you want to use is allowed or not: if it is forbidden, GEM Desktop won't let you type it in.

(For details on how to enter this information, see Section 2.10.)

5 Move the pointer to the [OK] exit button in the Dialog box and click the mouse button.

The directory now contains the new folder, which you can open and copy files and folders to in the normal way (see Section 4.2.2 below).

The GEM Desktop won't create the new folder if you try to give it the same name as another folder within the same directory. Instead it will display a Dialog box: this offers you the choice of either selecting a new name for the new folder (click on the [Retry] exit button) or abandoning the new folder (click on the [Cancel] exit button).

4.2.2 Copying existing files and folders

Copying a file or a folder makes a new file or folder that contains all the same information as the original. This copy can be stored either in the same directory as the original or in a different directory, often on a different disk.

The method of copying described here makes copies of one or more files or folders (or a mixture of the two). However, the files and folders must be all in the same directory, so if you want to copy files and folders from separate directories, you must repeat the process for each directory in turn.

The originals of the files and folders are known as the 'Source' and where the copies are stored is known as the 'Destination'. The destination can be shown on the screen:

- as the icon of the folder you want to store the copies in
- as a disk icon if you want to store the copies in the Root directory of this disk
- as empty space in a directory window if you want to store the copy in the folder whose directory is displayed on the screen

Note: If you have a single-drive PC and you want to copy a file from one floppy disk to another, you may be able to do this by copying the file first to the built-in disk drive (Drive C) and then copying from Drive C to the disk you want to store the file on. Each of these stages uses the steps described below. This will, however, fail if Drive C does not have enough room to store the file. If this happens, leave GEM temporarily and use the DOS command COPY instead, as described in Part I, Section 7.3 and in Part III, Section 5.2.

1 Display both the 'Source' directory and the 'Destination' on the screen.

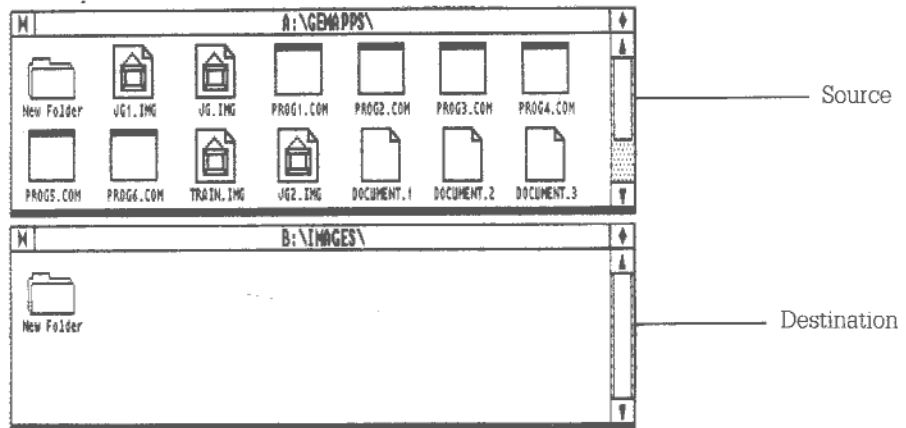

How to get the directories you want displayed on the screen is described in Section 4.1.3. If your destination is a disk icon, you will need to close up one of your windows as far as it will go to display this icon (see Section 2.8).

Note: If the copies are to be stored in the same folder as the original files and folders, you only need to display this folder once. You don't need to display it in two separate windows.

2 Select the icon or group of icons in the 'Source' folder representing the files and folders you want to copy.

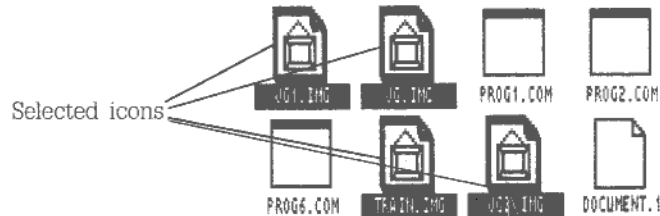

Selecting icons is described in Section 2.4.

Note: If you only want to copy one item, you can omit this step. The next step automatically selects the icon for you.

3 With the pointer over a selected icon, hold down the mouse button and then move the pointer to your chosen destination.

The pointer changes to a hand as you move it (see Section 2.4).

To determine what part of a directory window is 'empty', imagine a rectangle drawn around each icon and its name. The free area is anywhere still inside the window but outside these rectangles.

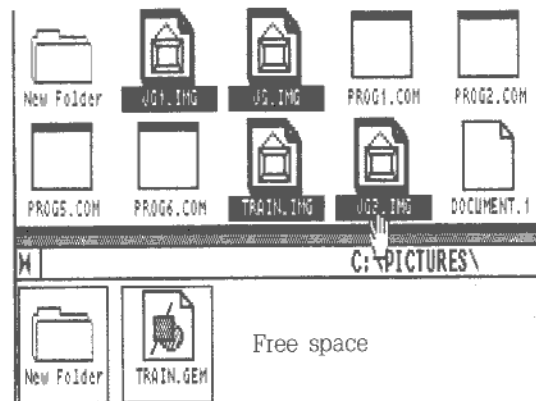

If your destination is an icon, this will become highlighted when you reach it.

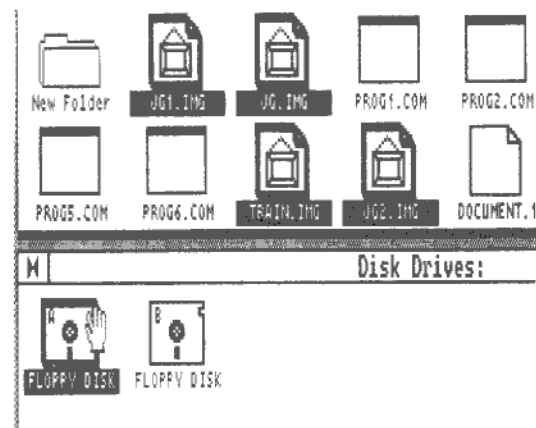

If you decide against copying, simply move the 'hand' back to its original position.

4 Release the mouse button.

The 'Copy folders/items' Dialog box is now displayed in the centre of the screen (unless you have specifically turned off the display of this box: see Section 8.1).

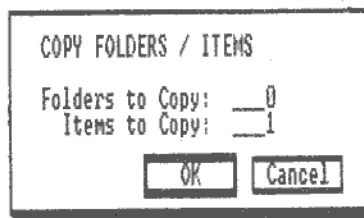

This tells you how many items GEM thinks you have asked it to copy. If there appears to have been some mistake, move the pointer to the [Cancel] exit button of the Dialog box and click the mouse button: then repeat Steps 2 - 4.

5 Move the pointer to the [OK] exit button of the Dialog box and click the mouse button.

GEM now starts copying the files and folders one by one into the destination folder. As each item is successfully copied, the number displayed in the Dialog box is reduced by one. If no Dialog box was displayed, you will see each file and folder in turn being picked out by a fine box and 'zoomed' into the destination folder.

Each new copy is stored with the same name as the original if this is possible. If this is not what you want, you can rename the copy after it has been created - provided the copy is of a file or a document.

It is not possible to rename a folder. What you can do instead (provided there is enough room on the disk) is to create a new folder with the new name (see Section 4.2.1 above), copy the contents of the old folder to the new folder and then delete the old folder (see below). If you don't have much room on the disk, copy each file separately and delete the old version immediately after copying the file.

GEM won't copy an item if it has the same name as folder or a file already stored in the Destination folder. Instead it will display a 'Name Conflict' Dialog box. What to do is described below in Section 4.2.5.

4.2.3 Deleting files and folders you no longer want

You can delete files and folders either one at a time or in a group (provided they are all in the same folder).

Deleting a file just removes that file. Deleting a folder deletes all the files in the folder and all the folders within the folder. These are likely to contain both files and further folders. Make sure that you want none of the files within any of these folders before deleting the folder containing them.

For example, suppose the pattern of folders on your disk was like this:

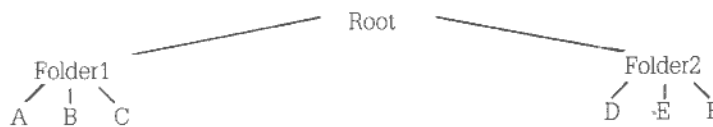

Deleting Folder 2 would delete folders D, E and F as well.

Deleting a file or a folder removes files from your disk: these files cannot be recovered. So it is wise to keep 'back-up' copies of important files in case of accident.

The steps to take are as follows:

1 Select the icons of the files and folders you no longer want.

The way to select a number of icons is described in Section 2.4.

2 Pull down the File menu and select 'Delete...': alternatively, hold the Alt key and press [D]

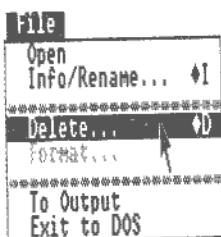

GEM then displays the 'Delete Folders/Items' Dialog box (unless you have turned off the display of this box - see Section 8.1).

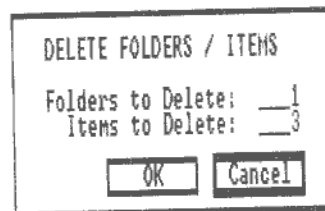

This box contains details of the number of items your PC thinks you have asked it to delete: if this appears to be wrong, select the [Cancel] exit button and repeat Steps 1 - 2.

How to select options from menus is described in Section 2.6.

3 Move the pointer to the [OK] exit button and click the mouse button.

GEM now deletes the files and folders one by one. Each time an item is deleted, the number shown in the Dialog box is reduced by one. If no Dialog box was displayed, the actual icons are removed one by one. The window is 'tidied up' again after all the files and folders have been deleted.

4.2.4 Giving a file a new name

Note: It is not possible to give a folder a new name. What you can do instead (provided there is enough room on the disk) is to create a new folder with the new name (see Section 4.2.1 above), copy the contents of the old folder to the new folder and then delete the old folder (see below). If you don't have much room on the disk, copy each file separately and delete the old version immediately after copying the file.

The new name you choose should:

- be different from any other file or folder name in this directory
- remind you of the information the file is used to store

The usual characters to use in the name are the letters A...Z and the numbers 0...9, but you can use some other characters as well (see Part 1, Section 8.4). You can easily tell whether a particular character can be used in a file name: GEM Desktop won't let you type in any forbidden characters.

The steps to take are as follows:

- 1 Select the icon of the file you want to rename.
- 2 Pull down the File menu and select 'Info/Rename...': alternatively hold down the **[Alt]** key and press **[I]**.

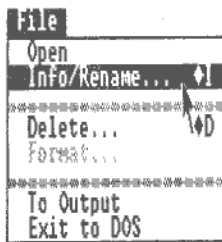

How to select an option from a menu is described in Section 2.6.

GEM then displays the 'Item Information/Rename' Dialog box, showing the current name of the file.

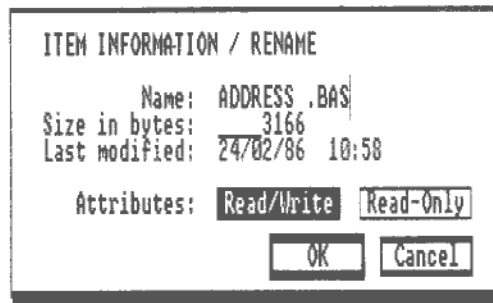

- 3 Edit the name shown in the Dialog box so that it becomes the new name.

The keystrokes to use to change the name are listed in Section 2.10. If you want to clear the old name before typing in the new one, press the **[Esc]** key.

- 4 Move the pointer to the **[OK]** exit button and click the mouse button.

- If the new name is acceptable, the file is then given this name.
- If the new name is already the name of a file in the same directory, your PC will display a special Dialog box. Go through Steps 1 - 4 again after leaving this Dialog box if you still want to rename this file.

4.2.5 When names conflict

Name conflicts arise because a single directory cannot contain two folders or two files with the same name. So when this appears about to happen, your PC displays a Dialog box.

The boxes displayed when you are naming a new folder and renaming files are explained in Section 4.2.1 and 4.2.4. This section describes the more complex box displayed when the conflict arises while a copy is being made.

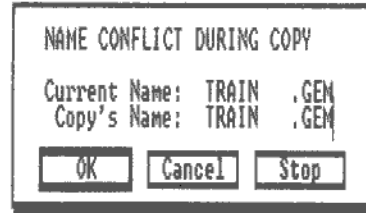

This box can either have no name next to 'Copy's Name' or (when a file is being copied) the same name next to both 'Copy's Name' and 'Current Name'.

- If a 'Current Name' is given but no 'Copy's Name', you must type in a new name that hasn't been used before as the 'Copy's Name' and then select the [OK] exit button. The copy will then be made.

- If the same name appears next to both 'Copy's Name' and 'Current Name', you can:

either change the name selected for the copy (the keystrokes to use are given in Section 2.10) and tell GEM to continue making the copy by selecting the [OK] exit button.

or replace the existing file with the new file by simply selecting the [OK] exit button.

or abandon copying this file by selecting the [Cancel] exit button. GEM then goes on to copying the next file you selected (if any).

or abandon the copy operation by selecting the [Stop] exit button.

Details of what characters can be used in file and folder names is given in Part I. GEM Desktop won't let you type in a name containing any forbidden characters.

4.2.6 Protecting important files

As you store your programs and data on disk, you should ask yourself whether you want to protect these files against being accidentally deleted or overwritten.

When files are created, they are marked as 'Read-Write' so that you can:

- read them
- change them
- delete them

However, this also means that you can accidentally destroy them.

You are advised to make regular security copies of your important files (known as 'back-ups') so that you always have a version you can use in the event of the disk you are working with being accidentally damaged or overwritten. Either back-up whole disks (by following the instructions in Part I, Section 6.1) or back-up individual files (see Section 4.2.2 above).

As an extra precaution, you can mark these files as 'Read-Only' which means:

- the files can be read into your PC's memory and processed
- the versions stored on the disk cannot be overwritten or erased

Back-up copies of files are made either individually or by copying whole folders of files or whole disks. How to make such copies is described in Section 4.2.2. How to mark a file as 'Read-Only' (and how to mark it later as 'Read-Write' again) is described below.

Whether you mark files as Read-Only or not, we strongly recommend making regular back-up copies of your important files.

- To mark a file 'Read-only' or 'Read-Write':

1 Move the pointer to the file you want to mark and click the lefthand mouse button.

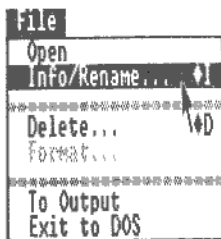

2 Pull down the File menu and select 'Info/Rename...': alternatively hold down the **Alt** key and press **I**

Section 2.6 describes how to do these actions.

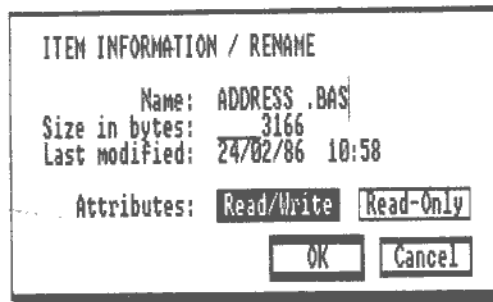

GEM displays a Dialog box giving the current details about the file. Near the bottom of the box are a 'Read-Write' box and a 'Read-Only' box. If the 'Read-Write' box is highlighted, the file is currently marked 'Read-Write'; if the 'Read-Only' box is highlighted, the file is currently marked 'Read-Only'.

3 Move the pointer to the box for the way you want to mark the file and click the mouse button.

If the box wasn't highlighted before, it will now be highlighted – showing that this option has been selected.

4 Move the pointer to the **[OK]** exit button and click the mouse button.

The file is now marked either 'Read-Write' or 'Read-Only' as you have selected.

5. PROCESSING YOUR DISKS

Floppy disks are processed in two ways:

- New blank disks are marked out electronically into the areas your PC will use for storing programs and information. This is called **Formatting**.
- Disks holding information you don't want to lose are copied so that you have a disk ready to use in case of accident. The copy is known as your **Back-up copy of the disk**.

This chapter describes how to carry out these two tasks when you are working with the GEM Desktop.

5.1 Preparing a new disk for use (Formatting)

Formatting a new blank disk marks it out into sections so that your PC can store and retrieve information from the disk. You may also want to format an old disk on which the data has become corrupted. If the disk hasn't been physically damaged, formatting the disk will enable you to use its storage space exactly as if it were a new disk. However, before you do this, do be sure to copy as many as possible of your files to other disks (see Section 4.2.2) before you format the disk. Formatting a disk wipes it clean of any stored data.

Note: If you have a single-drive PC, you should use the MS-DOS FORMAT command (see Part III, Section 6.1) to format your disks. You won't be able to use the method described here unless you can copy FORMAT.EXE from the \GEMSYS folder on the Desktop disk (Disk 3) to your RAM Disk (Drive C). You will also have to put Drive C on the program search path (see Part III, Section 4.2.4).

- **To format a disk:**

- 1 **Decide which of your two directory windows to work in.**
- 2 **Move the pointer to this window's Close Box ('bow-tie') and click the lefthand button on the mouse. Repeat this until the window is displaying your PC's disk drives.**

The window you require is entitled 'Disk Drives' and it is the furthest you can go in closing up a directory window.

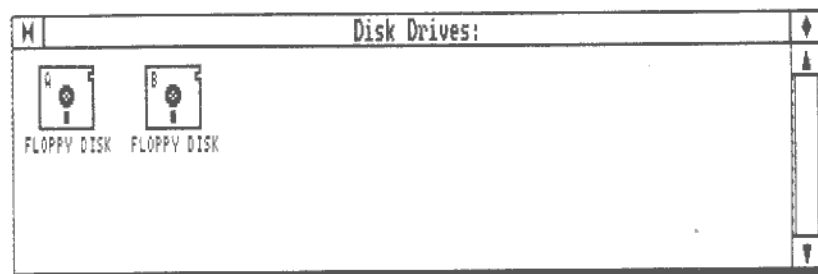

- 3 Insert the Desktop disk (Disk 3) in Drive A unless FORMAT.EXE is stored in Drive C and Drive C is on the program search path.
- 4 Move the pointer to the icon for the drive you are going to use to format the disk. Click the lefthand button on the mouse once.

Move the pointer to Disk A if you plan to format the disk in Drive A; move the pointer to Disk B if you have a two-drive system and plan to format the disk in Drive B.

Only select Disk A if Drive A doesn't hold your Desktop Disk.

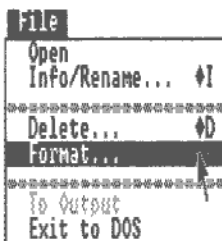
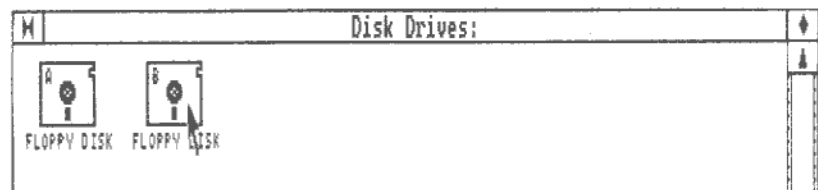

- 5 Move the pointer to the word 'File' in the menu bar at the top of the screen.

This causes the File menu to appear on the screen.

- 6 Move the pointer to the entry 'Format...' in the menu and then click the lefthand mouse button once.

The following Dialog Box then appears on the screen, asking you to confirm that you want to format the disk.

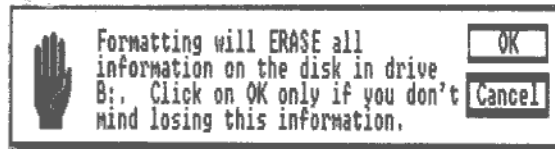

- 7 Check the details in the Dialog Box and that you do have the disk you want to format in the drive you have selected.
- 8 Insert the disk you want to format in the drive you have selected.
- 9 Move the pointer to the [OK] exit button and click the lefthand button on the mouse.

The disk is then formatted.

5.2 Copying a disk

The process of copying a disk using the GEM Desktop stores exact copies of all the files on the disk you copy on your second disk. The copies are then available for use if you accidentally damage or corrupt your original disk. In other words, copying a disk gives you a back-up set of the files on the disk.

Note: The method described here cannot be used if the disk has been copy-protected. However, the user guide supplied with the disk should tell you how to back-up the files it holds.

When you copy your disk, you can choose whether to store the copies on a newly formatted disk (ie. one that doesn't yet have any other files stored on it) or on a disk that already holds some files. Do not try to copy to an unformatted disk or one with the wrong format. If necessary, format the disk to give it the same format as your source disk **before** you copy files to it (see Section 5.1, above) or use the DOS DISKCOPY command (see Part III, Section 6.2).

Using a newly formatted disk can seem wasteful if there are only a few files on the disk you are copying, but it does ensure that there will be enough room to store all the files and that there won't be any name conflicts to sort out. (A name conflict arises when you want to copy a file that has the same name as a file already on the disk you are storing the copies on. How to sort out name conflicts is described in Section 4.2.5.)

Note: To use the method of copying described here, you need to have a PC with two disk drives (one of which can be Drive C, the RAM disk – ie. the area of the computer's memory that is used exactly as if it were another disk drive).

Leave the GEM Desktop temporarily (see Section 2.13) and then follow the instructions given in Part I, Section 6.4 on using the DISKCOPY.EXE program to copy the disk.

If part of your PC's memory is used as an additional drive (Drive C), then you can use this in a two-stage copy: first from the disk to Drive C and then from Drive C to the back-up disk. This will, however fail if Drive C does not have enough room to store all the files. If this happens, as is in fact quite likely, leave GEM temporarily and use the DOS command DISKCOPY instead, as described in Part I and in Part III.

● **To copy a disk:**

- 1 Decide which of your two directory windows to work in.**
- 2 Move the pointer to this window's Close Box ('bow-tie') and click the lefthand button on the mouse. Repeat this until the window is displaying your PC's disk drives.**

The window you require is entitled 'Disk Drives' and it is the furthest you can go in closing up a directory window.

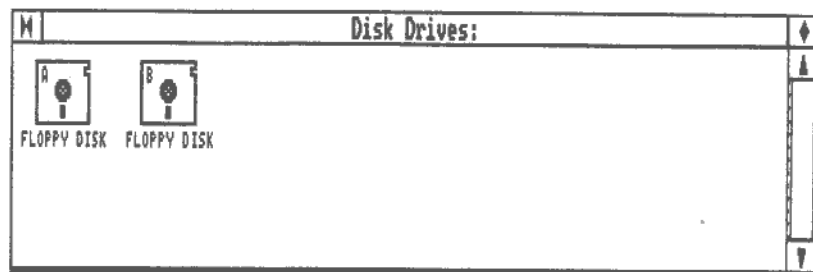

- 3 Insert the disk you want to copy in Drive A and, if appropriate, the disk you want to store the copy on in Drive B.
- 4 Move the pointer to Disk A's icon.

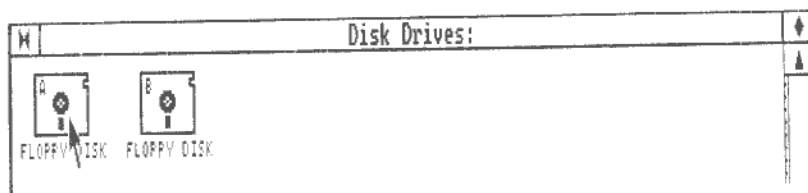

- 5 With the pointer over Disk A's icon, hold down the mouse button and then move the pointer to the icon that represents the disk you are going to store the copies on (Disk B or the RAM/Hard Disk, Disk C).

The pointer changes to a hand as you move it and the icon becomes highlighted as you reach it.



- 6 Release the mouse button.

The 'Copy folders/items' Dialog box is now displayed in the centre of the screen (unless you have specifically turned off the display of this box: see Section 8.1).

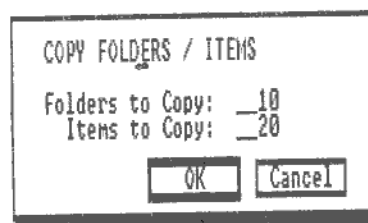

This tells you how many items GEM thinks you have asked it to copy. If there appears to have been some mistake, move the pointer to the [Cancel] exit button of the Dialog box and click the mouse button: then repeat Steps 4 - 6.

- 7 Move the pointer to the [OK] exit button and click the lefthand mouse button.

GEM now starts copying the files and folders one by one into the destination folder. As each item is successfully copied, the number displayed in the Dialog box is reduced by one. If no Dialog box was displayed, you will see the disk you are copying being 'zoomed' into the disk you are storing the copies on.

6. USING THE DESKTOP ACCESSORIES

The Desktop accessories are some special tools that you can always use whatever you currently have displayed on the screen. They are:

- a way of saving pictures of the screen, called Snapshot
- a clock with a built-in alarm system
- a calculator, with similar facilities to a small pocket calculator
- a print 'spooler', which helps you send text files to your printer

You select the accessory you want by:



- 1 Moving the pointer to the Menu bar and pulling down the Desktop menu.
- 2 Selecting the accessory you want.

How to do this is described in Section 2.6.

Using Snapshot, the clock and the calculator are described here: how to use the print spooler is described in Section 9.5.

Note: These accessories may not be available if your system uses more than 128k (typically) of its memory as a RAM disk (ie. for storing programs and data, rather than for processing them). You can change the amount of memory used as a RAM disk by changing the settings in the Battery-backed RAM – see Appendix II.

Snapshot is not loaded by the standard AMSTRAD PC Disks in order to conserve memory. If you want to use the Snapshot accessory, rename the file called SNAPSHOT in \GEMBOOT on Disk 2 to SNAPSHOT.ACC. The Snapshot accessory will be automatically loaded the next time the GEM Desktop is loaded (ie. after you use the GEM Startup disk or type the DOS command GEM).

6.1 Using Snapshot



Snapshot is used to save some or all of the current display on the screen.

The display is saved in a file with the filetype IMG, with further information stored in a companion file with the filetype GEM. Later, you can use GEM Paint to change the picture (see Part I, Section 5.2) or GEM OUTPUT to print it out or to display it on the screen (see Chapter 9).

GEM Paint and GEM OUTPUT appear to work with only one file. In fact both the IMG and its companion .GEM file must be in the same folder before either of these programs can work.

Taking a picture

- 1 Move the pointer to the picture of a camera and click the lefthand mouse button once.

The Item Selector Dialog box appears on the screen, asking you for a name to call the picture you are going to take.

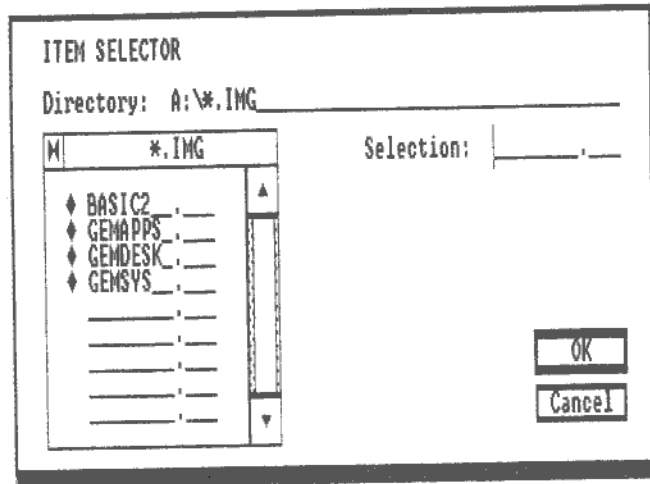

- 2 If necessary, change the folder displayed in the directory window of the Dialog box.**

How to do this is described in Section 2.11.

- 3 Type in a name of up to eight letters (no spaces), followed by a full stop and the letters I M G.**

For example, if you chose to call the picture MYSKETCH, you would type in:

MYSKETCH.IMG

You will see this name appear next to the label 'Selection' in the Dialog box.

- 4 Move the pointer to the [OK] exit button and click the lefthand mouse button once.**

The Snapshot window reappears, but this time with the camera and the question mark blacked out.

If you decide against saving the picture at this stage, move the pointer to the Snapshot window's 'bow tie' and click the lefthand button on the mouse once.

- 5 Move the pointer to the top lefthand corner of the part of the screen you want to take a picture of. Press and hold down the lefthand mouse button.**

- 6 Keeping the button held down, move the pointer to the bottom righthand corner of the area you want to take a picture of.**

You will see a shadowy box (a 'rubber rectangle') follow your pointer, marking out the area to be 'photographed'.

- 7 When the area the box shows is right, release the mouse button.**

Snapshot now takes a picture of the marked area of the screen and saves it on your disk.

Note: If you click on the question mark, rather than the picture of the camera, Snapshot will display a Dialog box that tells you briefly how to take a picture. Click on the [OK] exit button to return to the Snapshot window.

6.2 Using the clock

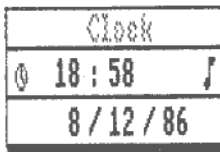

You use the clock:

- To display the date and the time
- To set the date and the time
- To display the time the alarm will go off
- To set the alarm

The time and date displayed by the clock are the ones stored in the Battery-backed RAM (see Appendix II: 'Setting the Battery-backed RAM') and used to record when your files are changed.

When you have finished with the clock, move the pointer to its close box (the 'bow tie' in the top lefthand corner) and click the lefthand mouse button.

In fact, you don't have to remove the clock from the screen. If you like, you can move the clock to the edge of the screen and leave it there while you work on the rest of the screen. (Bring the window you want to work on to the top by pointing to and clicking the lefthand mouse button once.)

Displaying the date and the time

- 1 Select the clock from the Desktop menu.
- 2 Look at the symbol to the left of the time: if it is a bell, move the pointer to the symbol and click the mouse button once (the symbol will change to a clock).

The current date and time is now displayed (24-hour clock).

Setting the time

- 1 To set the hour:

(i) move the pointer to the hour numbers and click the mouse button once

This selects the hour section of the time display

(ii) type in the correct hour as a two digit number 01...23

The hour is set when you type the second digit

- 2 To set the minutes:

(i) move the pointer to the minute numbers and click the mouse button once

This selects the minutes section of the time display

(ii) type in the correct minute as a two digit number 00...59

The minute is set when you type the second digit

Note: Your PC will bleep if you try to set an invalid time and forget what it was you were trying to set. Reselect this and try again, but beware – anything you typed after the PC bleeped will still be in its memory and may cause the PC to bleep again.

Setting the date

The date is given in the form *day/month/year*

1 To set the day:

(i) move the pointer to the day numbers and click the mouse button once

This selects the day section of the date.

(ii) type in the correct day as a two digit number 01...31

The day is set when you type the second digit.

2 To set the month:

(i) move the pointer to the month numbers and click the mouse button once

This selects the month section of the date.

(ii) type in the correct month as a two digit number 01...12

The month is set when you type the second digit.

3 To set the year:

(i) move the pointer to the year numbers and click the mouse button once

This selects the year section of the date.

(ii) type in the correct year as a two digit number 00...99

The year is set when you type the second digit. (Numbers 00...79 represent the years 2000...2079; 80...99 represent 1980...1999)

Note: Your PC will bleep if you try to set an invalid date and forget what it was you were trying to set. Reselect this and try again, but beware – anything you typed after the PC bleeped will still be in its memory and may cause the PC to bleep again.

- You should only have to set the date again if the batteries powering the battery-backed RAM go flat. The AMSTRAD PC's clock is pre-programmed to handle different numbers of days in a month and leap years.

Displaying the alarm time

W	. Clock
4	16:00
	14/9/86

1 Select the clock from the Desktop menu.

2 Look at the symbol to the left of the time: if it is a clock, move the pointer to the symbol and click the mouse button once (the symbol will change to a bell).

The time the alarm is set to go off is now displayed. The alarm will go off at this time if the musical note symbol to the right of the time is in light script (or red); if it is in dark script, the alarm has not been set to go off.

Setting the alarm

1 Use the steps described above for setting the clock to set the time the alarm is to go off.

Set just the time part of the display. You can set the alarm for a particular time but not for a particular date.

- 2 Look at the musical note symbol to the right of the time: if it is in dark script, move the pointer to the musical note symbol and click the mouse button once (the symbol will be rewritten in light script or in red).

The alarm is now set.

Note: The alarm time you set will be kept if you leave the GEM Desktop temporarily by selecting 'Enter DOS commands' from the Options menu (see Section 2.13). However, the alarm time will be lost if you leave GEM Desktop completely by selecting 'Quit' from the File menu (see Section 2.13).

6.3 Using the calculator

The calculator has the same functions as a typical pocket calculator.

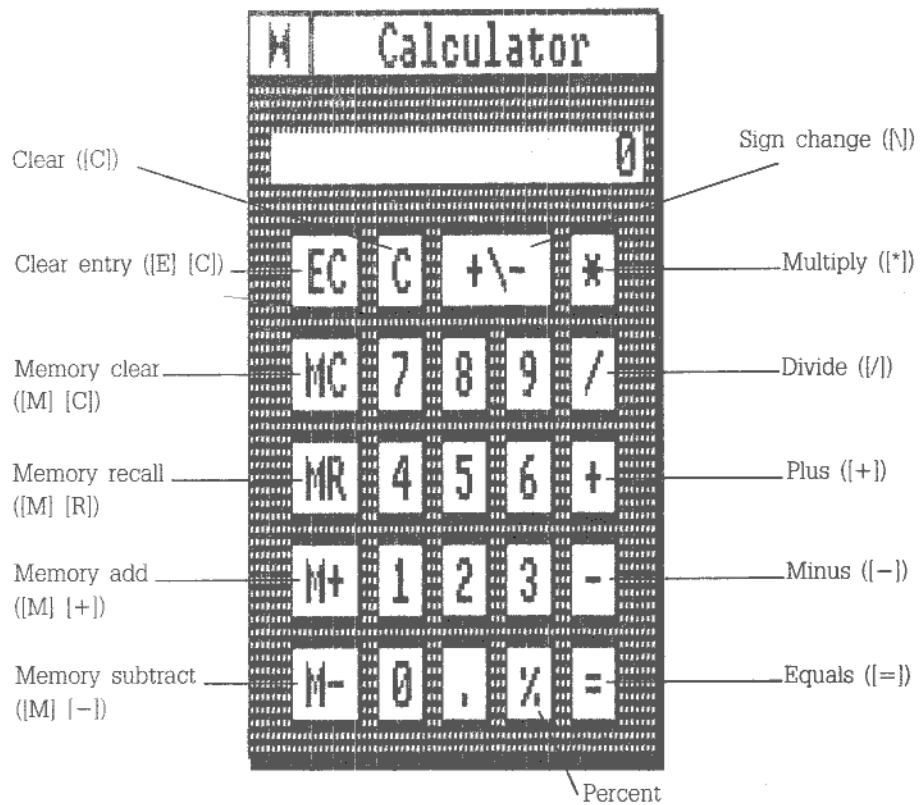

Alternative keyboard keystrokes in brackets

The **Clear entry** key is used to let you type in a number afresh after you have made a mistake: you don't lose your previous calculation.

The **Clear** key is used to clear the display and start a new calculation.

Many of the actions you take in using the calculator are also used by other programs that work with the GEM software – so using the calculator is good practice in using some of the GEM-based programs you might buy.

When you have finished using the calculator, move the pointer to its close box (the 'bow tie' in the top lefthand corner of the calculator) and click the lefthand mouse button.

Entering a number

Either Move the pointer to the number you want and click the mouse button once

Or Type in the number you want using either set of numbered keys on the keyboard. (If the numeric keypad gives you cursor movements rather than numbers, press the **Ctrl** key and then try again. When you press the **Ctrl** key, your PC will beep to tell you that the function of the cursor keys has changed. If the keypad still doesn't produce numbers, press the **Num Lock** key.)

Selecting a function key

Either Move the pointer to the 'button' on the calculator you want and click the mouse button once

Or Type in the appropriate keyboard equivalent shown on the diagram above

Note on using the percent key

(i) To find a simple percent, for example 17% of 5634, select the calculator buttons in the following order:

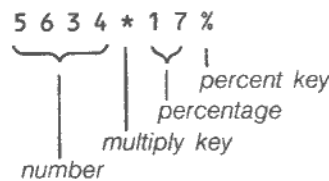

Do not use the [=] key.

(ii) To combine both a number and a simple percentage of it in a calculation – for example, $5634 - 17\%$ of 5634 – select buttons as follows:

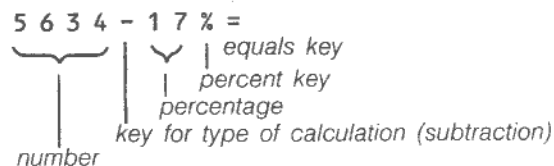

Using the memory functions

The memory of the Desktop calculator works in the same way as the memory of many handheld calculators. If you haven't used the memory since you switched on, you can store the number the calculator is currently showing on its screen in its memory by selecting [M+]. This number can then be recalled onto the calculator screen by selecting [MR].

If, however, you already have a number stored in the memory, selecting [M+] will add the number currently being displayed to the number already in the memory and store this new number in the memory. Selecting [M-] will subtract the number on the screen from the number already in the memory and store this new number in the memory. If you want to get rid of the old stored number and replace it with the number currently on the screen, you have to select [MC] and then select [M+].

You can tell if the memory is holding a number because there will be a small 'M' on the lefthand side of the calculator display area.

Note: Under some circumstances, the small 'M' will be displayed when you bring the calculator onto the screen. In this case, the number stored in the calculator's memory will be 0.

184

7. THE GEM DESKTOP MENUS

This is a reference chapter giving a summary of the options contained within the four menus on the GEM Desktop, together with directions to the parts of this manual where you can find further details.

7.1 The File menu



Open – opens the disk, folder or file which has been selected.

This has the same result as double-clicking the mouse button with the pointer on the icon (see Section 2.4).

Info/Rename... (♦I) – displays a Dialog box giving details about the object that has been selected and allows you to change some of these details.

The information given includes the object's full name, its size, when it was last changed, (for disks and folders) the number of folders and files ('items') contained in it and (for programs and documents) whether Read-Write or Read-Only access is allowed to the file. (See Section 4.1.4.)

If the object is a file, you can change its name and set whether Read-Only or Read-Write access is allowed to the file. (See Sections 4.2.4 and 4.2.6.)

Delete... (♦D) – starts the process of deleting the object or objects that have been selected.

The deletions will only be carried out after you have confirmed the details in a Dialog box, unless you have suppressed this display (see Section 8.1) when they will be carried out immediately. (See Section 4.2.3.)

Format – formats the disk that has been selected. (See Section 5.1.)

To Output – runs the GEM OUTPUT software which is used to display or print picture files generated by programs like GEM Draw and GEM Paint.

Using the GEM OUTPUT software is described in Chapter 9.

Exit to DOS – moves you over to using DOS fully.

The screen clears and the C> or A> system prompt is displayed. You can now type in DOS command lines. You will have to reload the GEM software before you can use GEM Desktop again. (See Section 2.13.)

7.2 The Options menu



Install Disk Drive... – starts the process of making the disk icons shown by GEM Desktop correspond to a new combination of disk drives.

(See Appendix V 'Expanding your AMSTRAD PC'.)

Configure Application... (♦A) – lets you specify the icon picture and the filetype for files associated with running your suite of software. (See Section 3.2.)

Set Preferences ... – lets you specify whether copying and deleting should be confirmed before they are carried out and set how fast the mouse button needs to be clicked. (See Section 8.1.)

Save Desktop (♦V) – saves your 'personalised' GEM Desktop and the details of new applications configured since you last reset your PC. (See Section 8.2.)

The information saved includes:

- the preferences you have set
- the current directory type and the way the directory is sorted
- the details of applications configured since you last reset your PC.

Enter DOS commands... (♦C) – allows you to leave GEM Desktop and use MS-DOS commands.

The screen clears and the C> or A> system prompt is displayed. You can now type in MS-DOS command lines. You can return to using GEM Desktop by typing **EXIT** after the system prompt. (See Section 2.13.)

7.3 The Arrange menu

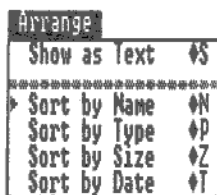

Show as Icons (♦S) – changes how directories are displayed from text to icons (See Section 4.1.1.)

Show as Text (♦S) – changes how directories are displayed from icons to text (See Section 4.1.1.)

Sort by Name (♦N) – displays files and folders in the directory in alphanumeric order of name. (See Section 4.1.2.)

Sort by Type (♦P) – displays files and folders in the directory in alphanumeric order of type. (See Section 4.1.2.)

Sort by Size (♦Z) – displays files and folders in the directory sorted according to their size.

The first folder and the first file listed are the largest in the directory. (See Section 4.1.2.)

Sort by Date (♦T) – displays the directory with the files sorted according to the date they were last modified.

The first file listed is the one changed most recently. The folders are not sorted. (See Section 4.1.2.)

7.4 The Desktop menu



Desktop Info... – displays details of the version of the GEM Desktop software you are running.

Snapshot – runs a program that takes a 'snapshot' of some or all of the current display and stores this on disk. (See Section 6.1.)

Note: Snapshot is not loaded by the standard AMSTRAD PC disks in order to conserve memory, but it is available. See Chapter 6 for details.

Calculator – runs the GEM calculator which offers you equivalent functions to a standard pocket calculator. (See Section 6.3.)

Clock – displays the GEM Desktop clock showing either the current time and date or the time set for an alarm. You can set both the clock and the alarm. (See Section 6.2.)

Print Spooler – enables you to change the list of picture files currently being sent to your printer or to start printing text files in this way. (See Section 9.5.)

188

8. PERSONALISING THE GEM DESKTOP

Personalising GEM Desktop is about specifying the features the Desktop will have when you first load it. The choices you can make are:

- which disks and folders are displayed immediately after loading the Desktop
- whether the contents of folders are displayed as icons (as supplied) or as text
- whether the contents of folders are sorted by name (as supplied), date, size or type
- how fast you have to double click the mouse button
- whether copying files and folders is confirmed before it is carried out (as supplied)
- whether deleting files and folders is confirmed before it is carried out (as supplied)
- whether your PC beeps when you do something wrong (as supplied)

Specifying these is a two stage process, carried out when you have the two 'directory' windows on the screen. First you need to make your selection for each of these features; then you need to save this combination. Saving the combination is referred to as Saving the Desktop.

The description in this chapter assumes that you are familiar with the basic techniques of using GEM - selecting icons, pulling down menus, etc. If you aren't, we strongly recommend that you study Chapter 2.

8.1 Setting the features you want

The operations described here set the features the GEM Desktop has on a temporary basis. The original settings return if you reset your machine. If you want to make these features more permanent, check that all the settings are as you want and then Save the Desktop as described in the next section. This process replaces the previous default settings with your new selection.

- **Setting which folders are displayed**

- 1 For each window in turn, open folders and/or close them up until the folder you want is displayed in the window.

If you wish, either or both of the directory windows can show the summary of the disk drives your PC has.

Note: In choosing which folders to show, think about which disks you will have in your drive(s) immediately after loading the GEM Desktop and what folders you have on those disks.

- Setting whether the contents of folders are displayed as icons or as text
- Setting how the items in the folder are sorted

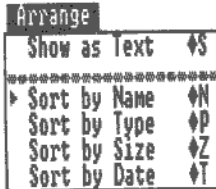

For each of these selections in turn:

- 1 Pull down the Arrange menu and select the option you want; alternatively, hold down the **Alt** key and press the appropriate character key.

Details are given in Sections 4.1.1 and 4.1.2.

- Setting how fast you double click the mouse button
- Setting whether deleting and copying files and folders are to be confirmed before they are carried out
- Setting whether your PC beeps when you do something wrong

Note: The following procedure is used to set any number of these features at the same time.

- 1 Pull down the Options menu and select 'Set Preferences...'

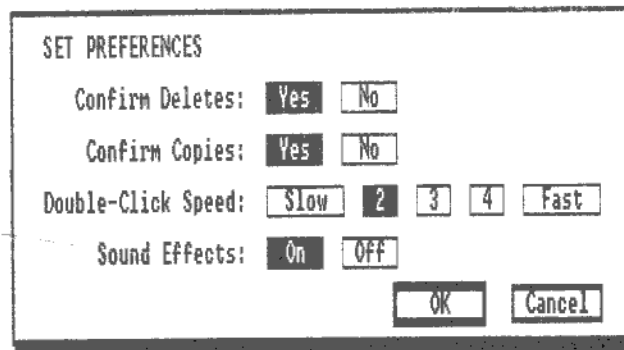

The Dialog box that appears on the screen shows the options you can take, with the current choices highlighted (shown in light characters on a dark background).

- 2 Move the pointer to a new option you want to select and click the mouse button. Do this for each new option you want (in any order).

Each new selection is now highlighted.

- 3 When you have set the combination you want, move the pointer to the [OK] exit button and click the mouse button.

8.2 Saving the Desktop

When you save the Desktop you save:

- the current choices set as Desktop preferences
- the current style of the directory (icons or text) and the way it is sorted
- which directories are displayed in the two directory windows
- the configuration details of any programs configured since your PC was last reset

Saving the Desktop is the only way to carry any of these details over to the next time you use your PC.

To save the Desktop:



- 1 Put your GEM Desktop disk in Drive A. Note that with the Hard Disk PC it is not necessary to change disks before selecting the 'Save Desktop' option.
- 2 Pull down the Options menu and select 'Save Desktop': alternatively, hold down the **Alt** key and press **V**

GEM then saves all the current choices.

192

9. OUTPUTTING PICTURES AND DOCUMENTS

A number of your GEM files will contain letters and documents you have prepared using word processing software or pictures produced by a graphics package such as GEM PAINT or GEM DRAW or the Desktop accessory SNAPSHOT. The GEM program that helps you display these is called OUTPUT. It can be used from the GEM Desktop and also from a number of GEM applications.

If you have a floppy disk system, before OUTPUT can be used, you need to organise your disks so that the following files are in either:

- the folder you are using at present;
- the \GEMSYS or \GEMAPPS folder on the disk you are using; or
- in a folder on the search path that you have set up by using the DOS command PATH (see Part III, Section 4.2.4)

This applies to using OUTPUT from the Desktop as well as from a GEM application. The files are:

- OUTPUT.APP, OUTPUT.RSC and DEFAULT.OPT
- The Device Driver for your chosen output device (unless you only want to use the screen)
- The Font files used by the program that generated the file you want to display (or you may get an inferior result)

A Device Driver supplies your computer's operating system with the information it needs about the output device. Each Font file contains the pattern for a particular size and style of text characters.

Always make sure that copies of all these files are available on an appropriate disk before you try to use OUTPUT. If you need advice on how to go about this, consult your dealer. There is also relevant advice in Appendix I, Section I.4.

Your AMSTRAD PC is supplied with a special output (and paint) disk (Disk 4) containing in the \GEMSYS folder:

- OUTPUT.APP
- OUTPUT.RSC
- DEFAULT.OPT
- EPSMONH6.SYS; a device driver suitable for use with any printer that is compatible with an Epson graphics printer eg. the AMSTRAD DMP3000.

Also included are a number of font files suitable for the graphics printer and your screen.

If you have a Hard Disk system, everything you need is already available.

If you would like to use a different type of printer or a plotter or a camera (with a suitable interface to your PC) or if you would like to use different sizes and styles of characters, consult your dealer. He should be able to get the device drivers and font files you need from Digital Research. You will then need to install these on your

computer (the steps to take are given in Appendix V).

Sometimes you will want to display just one file; at other times, you might want to display a number of files one after another. With GEM OUTPUT, you can even carry on with other work while 'printing in the background'.

This chapter describes how to use GEM OUTPUT. The description assumes that you are familiar with the basic techniques of using GEM – ie. selecting icons, pulling down menus, entering information in Dialog boxes, etc. If you aren't familiar with these actions, we strongly recommend that you study Chapter 2 first.

Overview of GEM OUTPUT

Using OUTPUT comprises:

- **selecting the files you want to display**
- **setting up the details of the display, for example whereabouts on the page you want a picture printed**
- **actually displaying the files, either on your screen or by printing them out on your printer while you do other tasks**

You tell OUTPUT which files to display by creating a list of these files. You can either create this list from scratch or you can use a list you have set up before or you can take a list you have set up before and change this into the list you want to output now. A substantial proportion of the facilities within OUTPUT are connected with setting up this list.

Once you have established your list of files, you can go on immediately to telling OUTPUT to display this list, how many times and on which Output Device (or you can simply save it for use another time). But first you may want to adjust how the picture will appear. For example, the standard settings may put a full scale picture centrally on each page of printer paper, when on this occasion you would like it scaled to fit the page area and placed towards the top lefthand corner of the page. Scaling pictures and positioning them on a page is also done with the help of OUTPUT.

At each stage, there are a number of options – including printing while you wait or printing while you get on with other work (see Section 9.2.1) and adding to the list of files to be printed after OUTPUT has started printing.

For this reason, it is only possible to give a straightforward set of instructions in the very simplest case – displaying one or more files when the output device (screen, printer etc.) has already been set up for displaying picture or document files. If you want to do anything more complicated, you will need to pick out from the sections which follow those that are relevant to what you want to do.

You are advised to become accustomed to using OUTPUT in this simple way, before you try using its more complex features.

Displaying one or more files

The method given here describes how to select files from a Directory window on the GEM Desktop and display these. If you run OUTPUT from a GEM application, you can use Steps 3 – 6 to display the document or picture you have just saved.

The files to be displayed:

- **MUST ALL BE IN THE SAME FOLDER**
- **Should all have been created by appropriate GEM programs and have the filetype .GEM or .OUT**
- or **be text documents created by non-GEM applications** provided these only contain ASCII characters. For example, the files produced by Wordstar in non-document mode could be displayed.

Note: If the application that produced the pictures generated two files when you saved the picture, use the file with the filetype GEM but make sure that you have the companion file in the same folder.

So, to output one or more files from the Desktop:

- 1 **Show the folder containing the file(s) you want to display on the screen.**
- 2 **Select the file(s) you want to display.**
- 3 **Pull down the File menu and select 'To Output'**

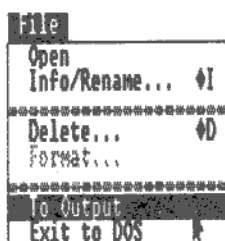

If the OUTPUT software isn't available to the program – because it isn't on the disk or it isn't in the \GEMSYS folder – the following Dialog box will be displayed on the screen:

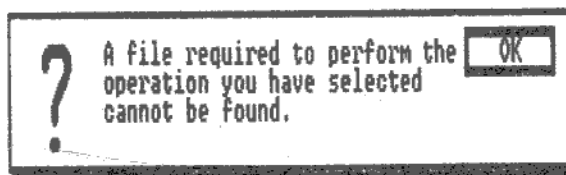

If this appears, click on the [OK] exit button and set to work copying the OUTPUT.APP and OUTPUT.RSC files to the \GEMSYS folder on your disk. (How to copy files is described in Section 4.2.2.) If you need advice on how to go about this, consult your dealer.

If the OUTPUT software is available, it will now run, giving you a new set of menus to work with. In particular, you have an 'OUTPUT' menu where before you had a 'DESKTOP' menu. This in fact still contains the clock and the calculator.

A special Dialog screen also appears, containing the name of the file you selected (known as an 'output list') with a second Dialog box on top – the Start Output Dialog box.

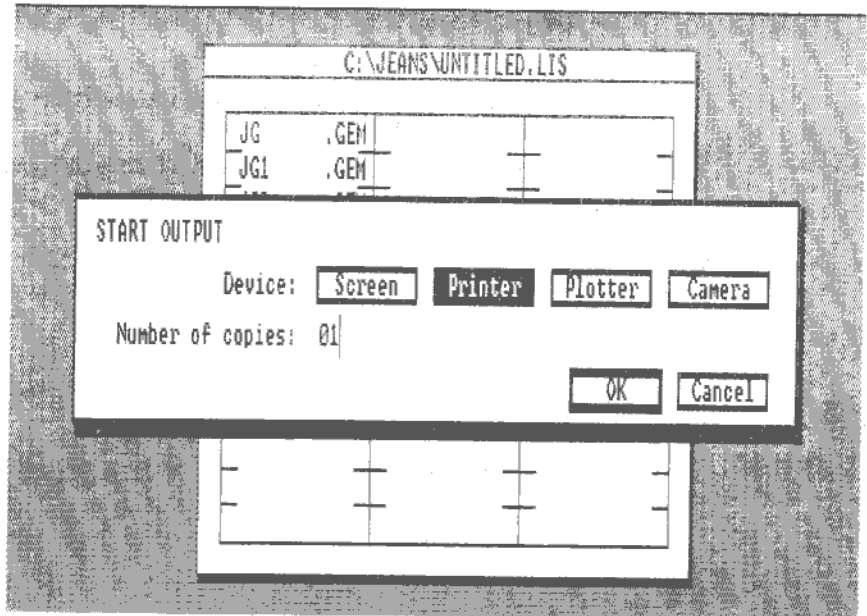

- 4 If the output device highlighted in the Start Output Dialog box is not the one you want to use, click on the one you do want to use.**

For example, if 'Screen' is highlighted when you want to send your pictures to your printer, move the pointer to 'Printer' and click the lefthand mouse button once. The printer will now be selected.

- 5 If you are outputting to a printer, plotter or camera, set the number of copies you want to make.**

Type in the number you want if this is different from the number already displayed.

- 6 Click on the [OK] exit button.**

The file(s) will now be output on your chosen device (after some seconds in which OUTPUT prepares the files for output). If you are displaying the files on a printer or a plotter rather than the screen, you will see a Dialog box on the screen that summarises the job to be done and tells you which file is being processed at the moment.

To return to using GEM Desktop, pull down the File menu and select 'Quit'.

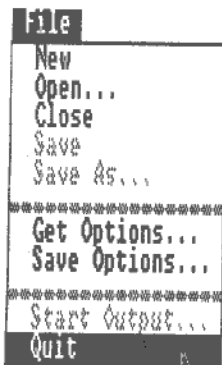

How GEM OUTPUT works

Flow of the program

You should decide

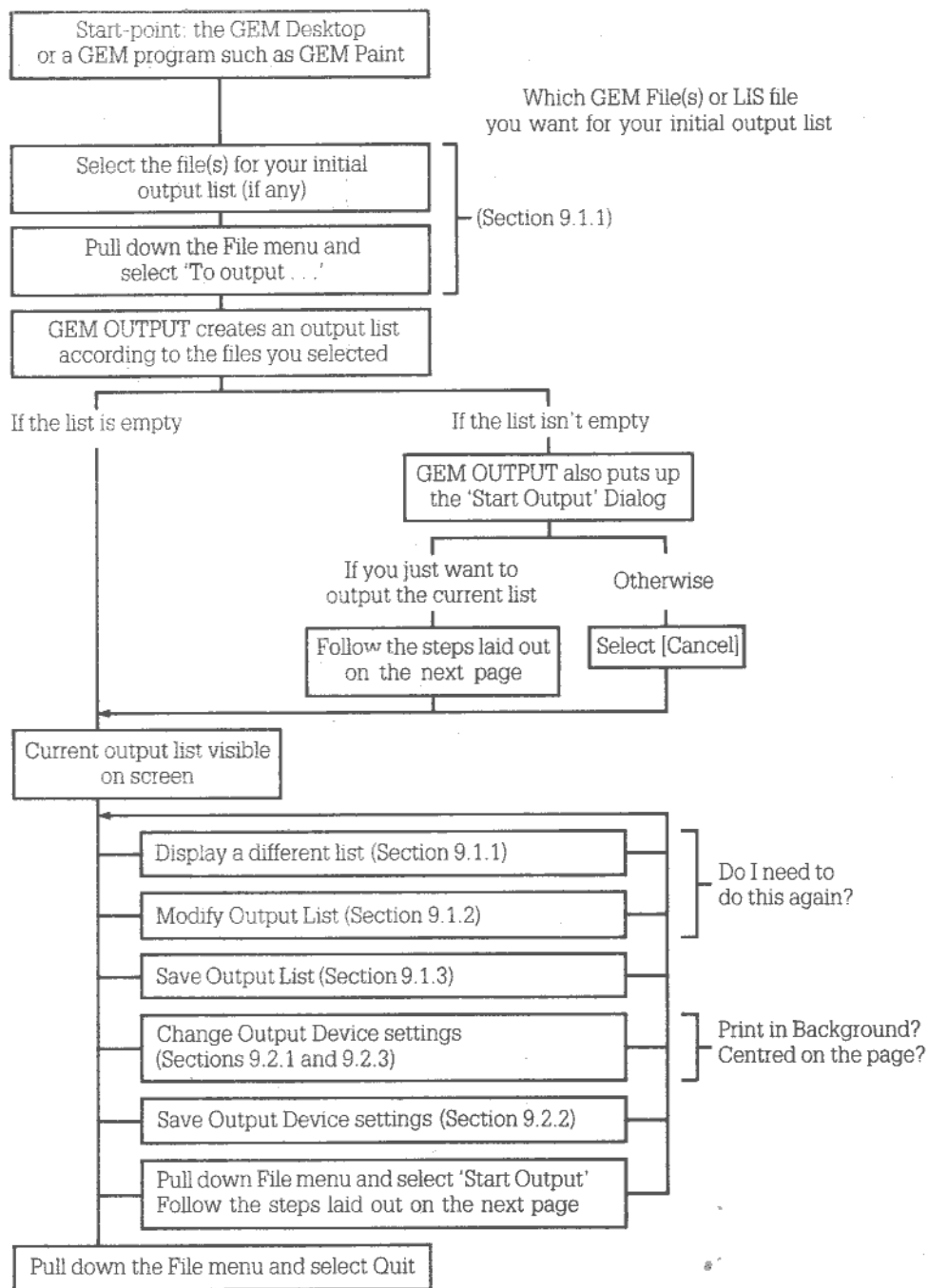

Outputting the picture(s)

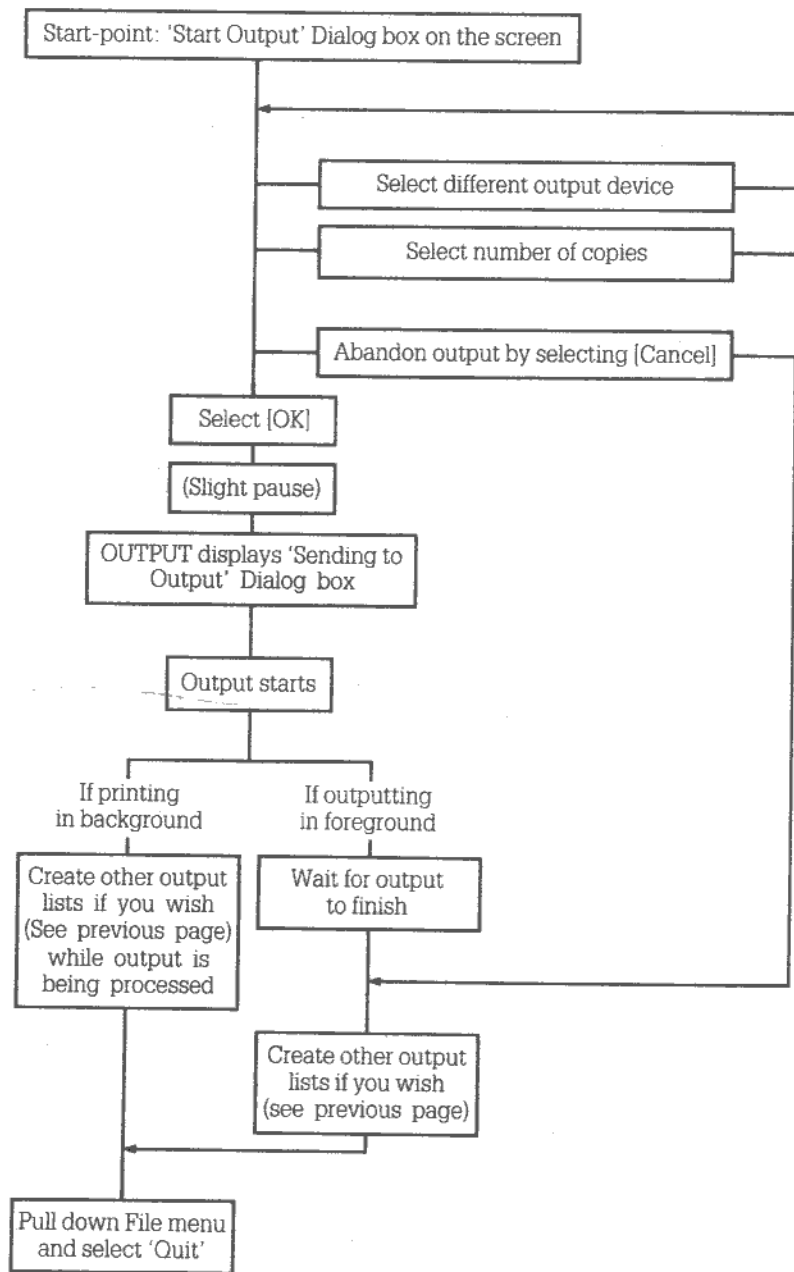

9.1 SETTING UP AN OUTPUT LIST

GEM OUTPUT can process up to 36 files in one batch. The files have to be all in the same folder and their names held in a special file known as an Output List.

The Output List you use can be:

- a list made up of a group of files you select first from the folder
- a list that you have already set up
- a new list to which you add the names of the files you want
- an existing list to which you add names of files you want and from which you remove the names of files you don't want

If the list isn't blank when it is first displayed on the screen, OUTPUT automatically puts up the START OUTPUT Dialog box on the screen so that, if you wish, you can start outputting the files in the list immediately. If you want to change the list in any way or you want to change an Output Device setting before the files are output, you should select the [Cancel] exit button from this Dialog box.

You can then:

- make any changes you want to the list (by following the instructions given in Section 9.1.2, below)
 - save the list before printing it out (see Section 9.1.3, below)
- and/or
- change the device settings (as described in Section 9.2).
- before going on to output the files (as described in Section 9.3)

9.1.1 Preparing the initial list

Your initial list can be:

- either** a list of files that you select before you start using OUTPUT
- or** an existing list, which you select either from the GEM Desktop or from within OUTPUT
- or** a blank list, which you can display either when you first enter OUTPUT or from within OUTPUT

All three options are available if you start from the GEM Desktop. Only the last two are available if you are using OUTPUT already.

From the Desktop

- **To generate a list of pre-selected files**
 - 1 Display the folder containing the files you want to output.**
 - 2 Select all the files you want to output.**
 - 3 Pull down the File menu and select 'To Output'.**

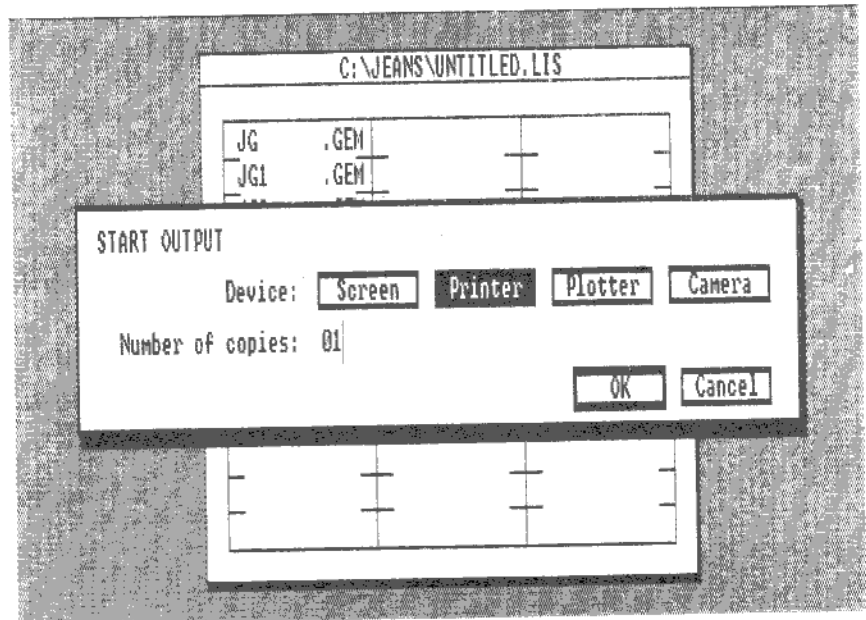

Provided GEM OUTPUT is available to the Desktop, it is now loaded (changing the menus that are available to you) and an 'untitled' list created, containing the names of the files you selected. (Seeing a Dialog box containing an error message probably means that GEM was unable to access the OUTPUT files: click on the [OK] exit button and check that OUTPUT.APP and OUTPUT.RSC are on the disk you are using and in the correct folder – see the introduction to this chapter.)

The files are listed in the order they appear in the unsorted folder (which may not be the order you want). There is also a possibility that some of the files you selected have not been put into the list, because the total details of the files transferred in this way may not exceed 128 characters.

The 'Start Output' Dialog is also displayed. If the list is as you want it and you don't want either to save the list or change how your Output Device is set up, select the Output Device you want to use (and type in the number of copies you want to make) and click on the [OK] exit button. Otherwise, click on the [Cancel] exit button.

- **To use an existing output list**

Existing output lists all have the filetype .LIS

- 1 Select the output list you want to use.**

- 2 Pull down the File menu and select 'To Output'.**

Provided GEM OUTPUT is available to the Desktop, it is now loaded (changing the menus that are available to you) and your selected output list is displayed on the screen. (Seeing a Dialog box containing an error message probably means that GEM was unable to access the OUTPUT files: click on the [OK] exit-button and check that OUTPUT.APP and OUTPUT.RSC are on the disk you are using and in the correct folder – see the introduction to this chapter.)

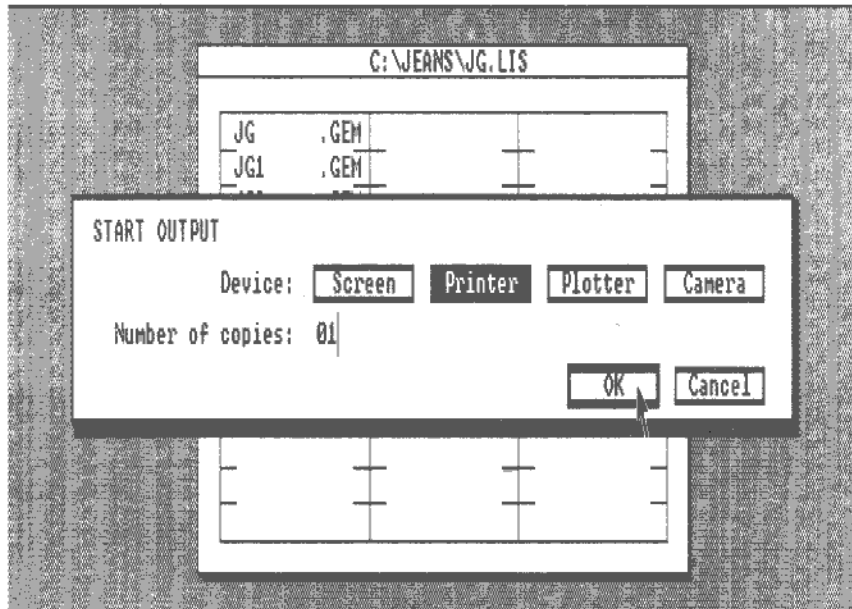

The 'Start Output' Dialog is also displayed. If the list is as you want it and you don't want either to save the list or change how your Output Device is set up, select the Output Device you want to use (and type in the number of copies you want to make) and click on the [OK] exit button. Otherwise, click on the [Cancel] exit button.

- **To start from a blank list**

- 1 **Pull down the File menu and select 'To Output'**

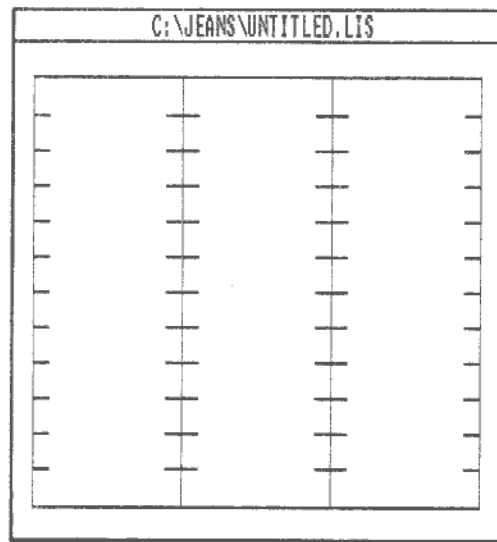

GEM OUTPUT is now loaded (changing the menus that are available to you) and a list with a dummy title (UNTITLED.LIS) is created. (Seeing a Dialog box containing an error message probably means that GEM was unable to access the OUTPUT files: click on the [OK] exit button and check that OUTPUT.APP and OUTPUT.RSC are on the disk you are using and in the correct folder – see the introduction to this chapter.)

From within GEM OUTPUT

- **To use an existing output list**

Existing output lists all have the filetype .LIS

- 1 Pull down the File menu and select 'Open...'**

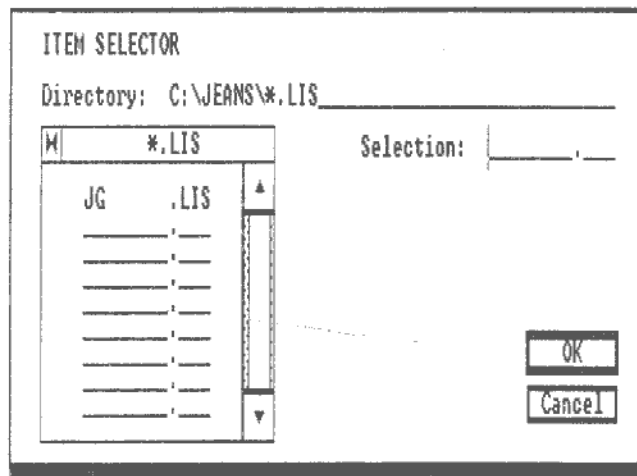

GEM puts up the 'Item Selector' Dialog box on the screen, asking for details of the Output List file you want to open.

- 2 Use the Item Selector Dialog box to pick out the list you want to use.**

How to select a file through this Dialog box is described in detail in Section 2.11.

- 3 Click on the [OK] exit button of the Item Selector Dialog box.**

The output list you have selected is now displayed on the screen.

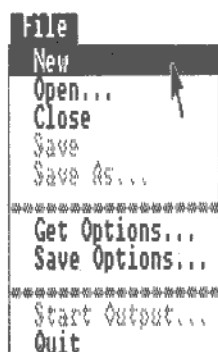
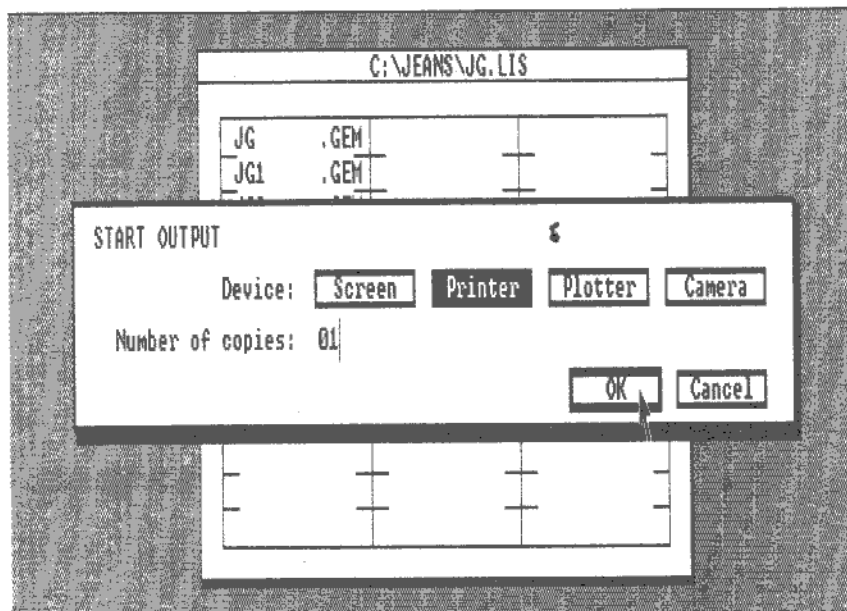

The 'Start Output' Dialog is also displayed. If the list is as you want it and you don't want either to save the list or change how your Output Device is set up, select the Output Device you want to use (and type in the number of copies you want to make) and click-on the [OK] exit button. Otherwise, click on the [Cancel] exit button.

● **To start from a new blank list**

- 1 Pull down the File menu and select 'New'.

A new 'untitled' output list is displayed.

Note: If you open a new list when you haven't saved the current list on your screen, GEM will prompt you to save this list. If you want to save it, click on the 'Cancel' box; then carry out the instructions in Section 9.1.3 (below) before returning here. If you don't want to save it, click on the 'Continue' box; the new output list is then displayed.

9.1.2 Changing the list

Adding to your output list

If you are adding names to a new list, you can choose which folder to take files from. If you are adding names to an existing list, the names you add must come from the same folders as the files already listed.



- 1 Pull down the Edit menu and select 'Add Name...'

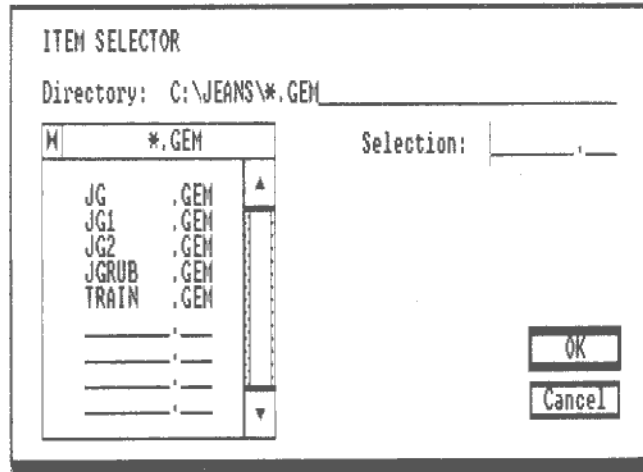

GEM puts up the 'Item Selector' Dialog box so that you can pick out the file(s) that you want to add to your output list.

- 2 Use the Item Selector Dialog box to pick out the names you want to add to the list.

How to select items through this Dialog box is described in detail in Section 2.11.

- 3 Click on the [OK] exit button of the Item Selector Dialog box.

All the files you have selected are added to the list in the order they appear in the folder (ie. before this has been sorted).

To return without adding any names to the list, click on the [Cancel] exit button.

Duplicating names in the output list

You can duplicate either one entry or many entries. Each new entry appears immediately below the entry it duplicates.

- 1 Select the entries you want to duplicate in the usual way.
- 2 Pull down the Edit menu and select 'Duplicate Name'.

The name(s) are now added to the output list.

Changing the order of the output list

You can change the order of the output list by moving entries in the list from one position to another, one by one. You can only move one entry at a time.

- 1 Move the pointer to the entry you want to move and hold down the mouse button.
- 2 Drag the pointer to the new position for the file.

If you want the entry to appear further down the list, drag the pointer to the entry in the list you want the moved file to follow.



If you want the entry to appear higher up the list, move the pointer to the entry in the list you want the moved file to precede.

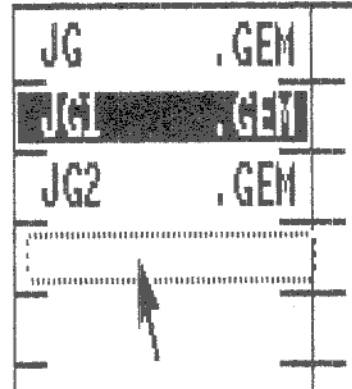

3 Release the mouse button when the outline is in the correct position.

In particular, ensure that the top edge and the lefthand edge of the outline are in the right section of the list.

The entry is moved to its new position and the other entries shifted to accommodate it. The entry itself remains highlighted until you either select another entry to move or move the pointer to a blank section of the output list and click the mouse button once.

Removing items from your list

You can remove either one entry or many entries in one operation.



- 1 **Select the entries you want to remove in the usual way.**
- 2 **Pull down the Edit menu and select 'Delete Name'.**

The name(s) are now removed from the output list.

9.1.3 Saving your Output List

Saving your Output List makes it available for use later. There is no need to save the list if you just want to use it now.

The list you save will either be:

- **a new list you have just set up, or**
- **an existing list that you have changed in some way.**

If you want to save a new list, you have to save it under a new name: its current name of 'UNTITLED.LIS' is only a 'dummy' name.

If you created the new list by changing an existing list, you have two choices:

- to save the new version under a new name (and keep the old version under its old name)

or - to replace the old version with the new version

Note: All files containing output lists must have the filetype LIS.

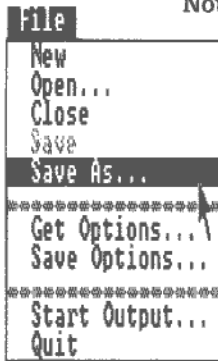

Saving under a new name

- 1 Pull down the File menu and select 'Save As ...'

GEM puts up the 'Item Selector' on the screen, asking for details of the name you want to give the saved file.

- 2 If necessary, select a different folder as the destination for this file by changing the folder displayed in the Dialog box's directory window.

The ways the folder can be changed are described in Section 2.11.

- 3 Type in your chosen file name for this file in the text area labelled 'Selection'.

Remember that the filetype must be LIS.

Typing in and editing information in a Dialog box is described in Section 2.10.

- 4 Click on the [OK] exit button.

Your Output List is then stored under your chosen name.

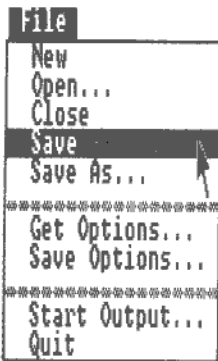

Saving under the old name

- 1 Pull down the File menu and select 'Save'.

The existing file is then updated.

- The Output List remains on the screen after it has been saved, so that you can print it out immediately if you want.

9.1.4 Closing up the list currently on the screen

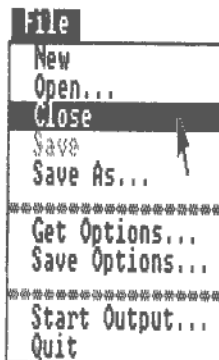

- 1 Pull down the File menu and select 'Close'.

What happens depends on whether this list has been saved and whether it has been changed since it was last saved.

If the list has not been saved, GEM acts as if you asked for the 'Save As...' option and displays the Item Selector Dialog box. Follow the instructions in Section 9.1.3 above if you want to save the list; otherwise select the 'Cancel' exit option.

Note: It isn't necessary to close up the current Output List before opening another list (see Section 9.1.1, above).

9.2 SETTING UP YOUR OUTPUT DEVICE OPTIONS

With GEM OUTPUT, you have a choice of Output Devices:

- the screen
- a printer
- a plotter
- a camera

Each of these can be set up in a number of different ways. For example, on a plotter, pictures can be positioned centrally or over to the left or over to the right.

GEM OUTPUT has built into it 'default' settings for each of these Output Devices, which it will use if you don't specifically change any of these. To change them, you can either select from the available options according to the settings needed for your current job (see Section 9.2.1, below) or you can use settings selected and saved on a previous occasion (see Section 9.2.3, below).

Separate actions are involved in setting up the screen, a plotter, a printer and a camera. All of them start with pulling the Options menu onto the screen.

9.2.1 Setting up the individual Output Devices

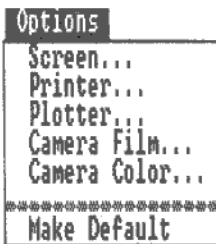

Setting up the screen display

- 1 Pull down the Options menu and select 'Screen...'

GEM then displays the 'Screen Options' Dialog box. The options that are currently selected are highlighted.

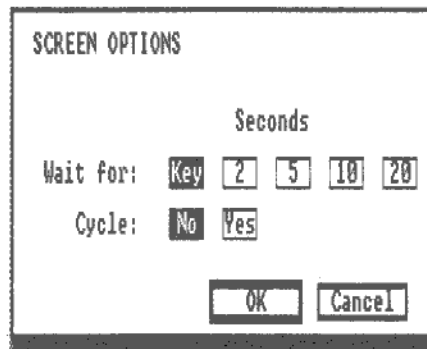

- 2 Click on the new options you require.

The **Wait for** options let you choose how GEM OUTPUT will know to move on to displaying the next picture in the output list. If you select 'Key', GEM OUTPUT will wait for you to press a key before moving on to the next picture; if you select one of the numbers, GEM OUTPUT will wait for that number of seconds before moving on to the next picture. If you select 'Key', you will be able to go back to the previous picture by pressing .

The **Cycle** option lets you choose whether GEM OUTPUT stops after it has displayed each of the pictures once or whether it will go back to the beginning of the list and start again. Select 'No' if you want GEM OUTPUT to stop; select 'Yes' if you want it to keep 'cycling' through the list.

3 When you have set the options you require, click on the [OK] exit button.

Setting up the plotter output

1 Pull down the Options menu and select 'Plotter...'

GEM then displays the 'Plotter Options' Dialog box. The options that are currently selected are highlighted.

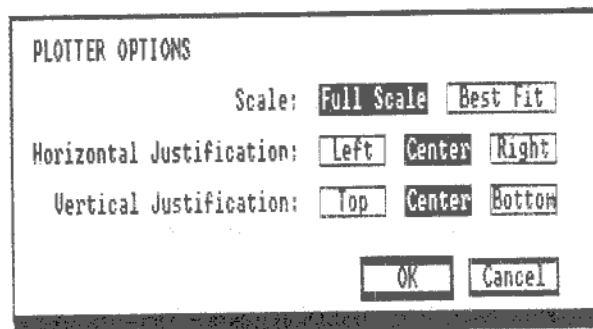

2 Click on the new options you require.

The **Scale** options let you choose whether you want the picture to be drawn exactly as you set it up or scaled to fit on the paper your plotter uses. If you want GEM OUTPUT to adjust the size of the picture to fit the paper, select 'Best Fit'; otherwise, select 'Full scale'.

The **Justification** options let you select the position on the page the picture will have. You can place the picture centrally, or to the right or to the left, or towards the top or towards the bottom of the page.

3 When you have set the options you require, click on the [OK] exit button.

Setting up the printer output

1 Pull down the Options menu and select 'Printer...'

GEM then displays the 'Printer Options' Dialog box. The options that are currently selected are highlighted.

PRINTER OPTIONS

Scale: Full Scale Best Fit

Initial Form Feed: Yes No

Final Form Feed: Yes No

Horizontal Justification: Left Center Right

Vertical Justification: Top Center Bottom

Print in Background: Yes No

2 Click on the new options you require.

The **Scale** options let you choose whether you want the picture to be drawn exactly as you set it up or scaled to fit on the paper your plotter uses. If you want GEM OUTPUT to adjust the size of the picture to fit the paper, select 'Best Fit'; otherwise, select 'Full scale'.

If you want the printer to put a blank sheet of paper at the beginning of your print-out, select 'Yes' beside **Initial Form Feed**. Otherwise select 'No'.

If you want the printer to put a blank sheet of paper at the end of your print-out, select 'Yes' beside **Final Form Feed**. Otherwise select 'No'.

The **Justification** options let you select the position on the page the picture will have. You can place the picture centrally, or to the right or to the left, or towards the top or towards the bottom of the page.

If you would like to return to GEM Desktop and do other work while OUTPUT prints your pictures, select 'Yes' beside **Print in Background**. Selecting 'No' keeps you in GEM OUTPUT until everything has been printed. Note: If this option is written in lightened text, your system doesn't have enough memory available at present to support background printing.

3 When you have set the options you require, click on the [OK] exit button.

Setting up for your camera film

Setting the film type

1 Pull down the Options menu and select 'Camera film...'

GEM then displays the 'Film Options' Dialog box. The options that are currently selected are highlighted.

CAMERA FILM OPTIONS	
Film Type	Lightness
<input checked="" type="checkbox"/> Polaroid 669/691	<input type="text" value="-3"/>
<input type="checkbox"/> Polaroid Polachrome	<input type="text" value="-2"/>
<input type="checkbox"/> Ektachrome 100	<input type="text" value="-1"/>
<input type="checkbox"/> Agfachrome 100	<input checked="" type="text" value="0"/>
<input type="checkbox"/> Fujichrome 100	<input type="text" value="+1"/>
<input type="checkbox"/> Reserved for future use	<input type="text" value="+2"/>
<input type="checkbox"/> Reserved for future use	<input type="text" value="+3"/>
<input type="button" value="OK"/> <input type="button" value="CANCEL"/>	

2 Click on the new options you require.

The **Film type** options let you set up GEM OUTPUT for the film loaded in your camera. It is important that the option matches the film you are using.

The **Lightness** options let you adjust the darkness or lightness of your pictures. If you are using print film, -3 gives you the darkest print and +3 the lightest. If you are using slide film, -3 gives you the lightest print and +3 the darkest. You may have to experiment a little to get the best results.

3 When you have set the options you require, click on the [OK] exit button.

Setting the colour balance

1 Pull down the Options menu and select 'Camera Color...'

GEM then displays the 'Color Options' Dialog box, showing the different colours available to you.

CAMERA COLOR OPTIONS

Color Index: 0 1 2 3 4 5 6 7
 8 9 10 11 12 13 14 15

Current Color Setting

Basic Color: White Black Red Green Blue Cyan
 Yellow Magenta Brown Orange Grey Purple

Lightness: Light 2 3 4 5 6 7 8 9 Dark

Red: 100 %
Green: 000 %
Blue: 000 %

Each **Color Index** represents a different colour, and each corresponds to a different colour code used by GEM Draw, GEM Paint and other GEM painting and drawing programs. The **Basic Colors** give the choice of colours. The **Lightness** settings give the range of intensities available.

When the Dialog box is first displayed, none of the options are highlighted. But clicking on a Color Index brings up the Basic Color and the Lightness that this Color Index represents. The percentages following 'Red', 'Green' and 'Blue' give the amounts of red, green and blue corresponding to this basic colour and lightness. '0' after one of the colours says that colour is not included; '100' says that the colour is present at full strength.

2 Click on each 'Color Index' you want to change.

The Basic Color, Lightness and red, green and blue percentages corresponding to this colour index are then displayed.

3 Change the colour associated with the Color Index by clicking on the components you require.

To change the Basic Color, click on the colour option you want. (This automatically changes the mix of red, green and blue as well.) To change the Lightness, click on the lightness option you want. (Again, this changes the mix of red, green and blue.) If you want to change the meaning of the colour, you should click on 'Red', 'Green' or 'Blue' as appropriate and type in the percentage of this colour you want. You will probably need to experiment with these settings before you get precisely the colours you want.

4 When you have set the options you require, click on the [OK] exit button.

9.2.2 Saving your device settings

Having set up your devices, you can save these:

- either as a file that you can use again later, whenever you want to output the same or a similar set of pictures
- or as the default options for GEM OUTPUT to use in future

Saving in a file

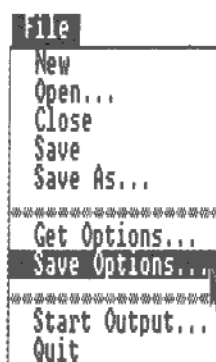

- 1 Pull down the File menu and select 'Save Options...'

GEM puts up the 'Item Selector' on the screen, asking for details of the name you want to give the saved file.

- 2 If necessary, select a different folder as the destination for this file by changing the folder displayed in the Dialog box's directory window.

The ways the folder can be changed are described in Section 2.11.

- 3 Type in your chosen filename for this file in the text area labelled 'Selection'. You must give it the filetype OPT.

- 4 Click on the [OK] exit button.

Your chosen set of options are stored in the file you have specified.



Making the current options the default set

- 1 Replace the disk in Drive A by your Desktop disk. Note that with a Hard Disk PC it is not necessary to change disks before saving the options.

- 2 Pull down the Options menu and select 'Make Default'.

GEM OUTPUT then saves the current options in a file called DEFAULT.OPT on your Desktop disk. If there is already a file called DEFAULT.OPT on this disk, it will be overwritten. GEM will automatically set these options in future every time you start using GEM OUTPUT.

Note: If later you want to go back to using the original default set of options, delete the DEFAULT.OPT file. The file is stored in the GEMSYS folder on your Desktop disk and it can be deleted from GEM Desktop.

9.2.3 Using a saved set of device settings

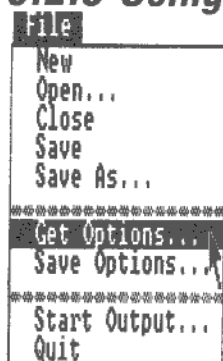

The following instructions change the current device options to those saved in a particular file. (The file will have the filetype OPT.)

- 1 Pull down the File menu and select 'Get Options...'

GEM then puts the Item Selector Dialog box on the screen.

- 2 Use the Item Selector Dialog box to select the file holding the options you want.

Selecting a file from within the Item Selector Dialog box is described in Section 2.11.

3 Click on the [OK] exit button.

Note: To restore the default device settings, repeat this procedure but this time select DEFAULT.OPT.

9.3 OUTPUTTING PICTURES

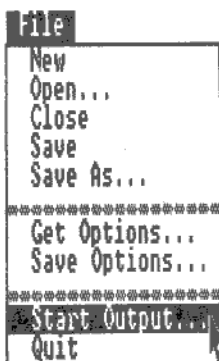

The pictures you output can be either those listed in the Output List currently on your screen or those listed in a saved list.

If you want to output the contents of a different list to the one currently displayed on the screen, save this list if you want (see Section 9.1.3) and then pull down the File menu and select 'Open...'. Use the Item Selector Dialog box that then appears on the screen to bring the output list you want onto the screen. (How to select a file through this Dialog box is described in Section 2.11.)

1 Pull down the File menu and select 'Start Output...'

GEM then displays the 'Start Output' Dialog box.

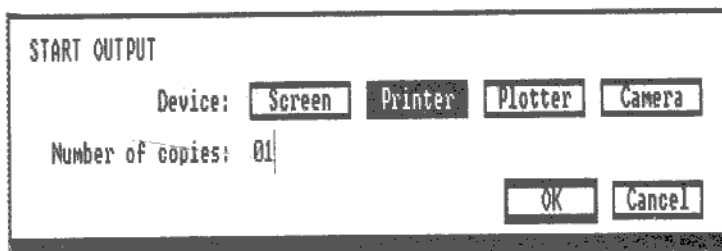

2 If the wrong output device is highlighted, click on the one you want.

The output device shown is the one you last used or the default option.

3 If you are sending your output to a printer, a plotter or a camera, you can also change the number of copies of each picture to be made. Click on the current number and then type in the number you require.

The number displayed is the number you last set or the default option (1). The number of copies displayed on the screen is always 1 and this cannot be changed. (When the screen is the chosen output device, 'Number of copies' is written in light text to remind you that this number cannot be changed.)

4 Click on the [OK] exit button.

The file(s) will now be output on your chosen device (after some seconds in which OUTPUT prepares the files for output). If you are displaying the files on a printer or a plotter rather than the screen, you will see a Dialog box on the screen that summarises the job to be done and tells you which file is being processed at the moment.

You can stop the output at any time by pressing the **Esc** key: GEM OUTPUT then stops when it has finished outputting the current picture. (Pressing **Esc**, when you are displaying your files on the screen, stops the display immediately.)

If you are sending pictures to the screen and the screen is set to wait for a key to be pressed before it goes on to the next picture, you can use:

- the **↑** key to go back to the previous picture
- any other key to go on to the next picture.

If you are sending the pictures to your printer in the background and you want to change your mind about printing some of the files in the list, you can use the Print Spooler described in Section 9.5 below. The Print Spooler can also be used:

- to add simple ASCII text files to the list of documents to be printed
- to create a list and print ASCII text files

To finish using GEM OUTPUT, pull down the File menu and select 'Quit'.

This returns you either to the GEM Desktop or to the program you were running when you started using GEM OUTPUT.



9.4 OUTPUT MENU SUMMARY

This section gives you a summary of the options contained in the three GEM OUTPUT menus, together with details of the sections where further details are given.

9.4.1 The File menu

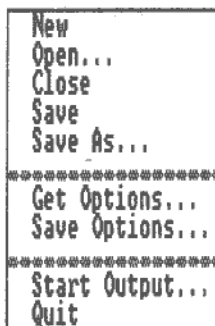

New - Clears the current output list without saving it and displays a new untitled list on the screen (see Section 9.1.1).

Open... - Displays the output list you want on the screen.

You will use this to bring a saved output list onto the screen before outputting it on your chosen output device (see Section 9.3) or before editing it in order to create a new output list (see Section 9.1.1).

Close - Closes the current list and removes it from your screen (see Section 9.1.4).

Save - Overwrites an existing output list with an edited version of the list (see Section 9.1.3).

Save As... - Saves a new output list or a new version of an existing list as a separate file (see Section 9.1.3).

Get Options... - Sets up the output device options according to details stored in a file (see Section 9.2.3).

If you want to go back to using the default device options, the file you want to select is DEFAULT.OPT, which is stored in the GEMSYS folder on your Desktop disk.

Save Options... - Saves the current device options as a file (see Section 9.2.2).

If you want to save these as your default set, you don't want to use this option. Instead you should use the 'Make Default' option from the Options menu.

Start Output... - Starts the process of outputting the current output list (see Section 9.3).

Quit - Stops GEM OUTPUT and returns you either to the GEM Desktop or to the program you were running when you chose to start running OUTPUT

9.4.2 The Edit menu

```
Add Name...
Duplicate Name
Delete Name
```

Add Name... - Starts the process of adding a name to the output list you are preparing on the screen (see Section 9.1.2).

Duplicate Name - Duplicates the name of any files in the current list that are highlighted (ie. the files that you have selected).

The new entry appears immediately below the entry it duplicates (see Section 9.1.2).

Delete Name - Removes from the current list any files that are highlighted (ie. the files that you have selected). (See Section 9.1.2.)

9.4.3 The Options menu

```
Screen...
Printer...
Plotter...
Camera Film...
Camera Color...
*****
Make Default
```

Screen... - Starts the process of selecting screen options (see Section 9.2.1).

Plotter... - Starts the process of selecting plotter options (see Section 9.2.1).

Printer... - Starts the process of selecting printer options (see Section 9.2.1).

Camera Film... - Starts the process of setting the camera options to match the type of film you use in your camera (see Section 9.2.1).

Camera Color... - Starts the process of changing how the colour codes in your picture files are reproduced (see Section 9.2.1).

Make Default - Stores the current device settings as the default options for future use.

If you have a floppy disk PC, the process overwrites the DEFAULT.OPT file on your Desktop disk, which you should put in Drive A before you select this option. (See Section 9.2.2.)

9.5 USING THE PRINT SPOOLER

The Print Spooler is a GEM accessory which you can use from the Desktop or any other program with this accessory:



- to remove files from the list currently being sent to your printer by GEM OUTPUT
- to add simple ASCII text files to the list of files currently being printed
- to start printing one or more ASCII text files, without calling on GEM OUTPUT

The same steps are involved in all cases.

- 1 Pull down the Desktop (or equivalent) menu and select 'Print Spooler'.

The special 'Print Spooler' window is displayed. Any picture files that are being printed at the moment are listed in this window, with the one currently being printed at the top of the list. If nothing is being printed, the window is blank.

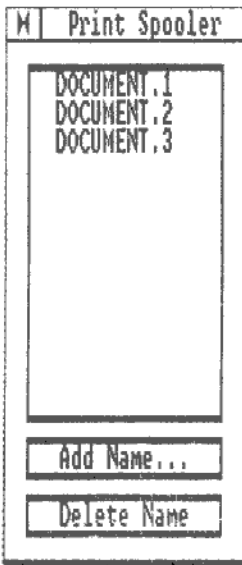

- 2 If you want to add text files to the print list, click on the 'Add name...' box.

The 'Item Selector' Dialog box is then displayed. (Printing stops when this Dialog box appears and only starts again when you have finished using it.) Use the Dialog box to select the text files you want to add to the list. (How to do this is described in Section 2.11.)

Note: All the files in a print list must be stored in the same folder: you won't be allowed to add files from a different folder.

- 3 If you want to remove a file from the print list, click on its name and then click on the 'Delete Name' box.

If you remove the file that is being printed at the moment, GEM OUTPUT will stop printing this immediately and start the next one on a fresh sheet of paper.

Note: You can add new files or remove files as long as the Print Spooler window is on the screen.



- 4 When you have finished using the Print Spooler accessory, click on its window's Close Box.

10. ALTERNATIVES TO USING THE MOUSE

The mouse is the easiest tool to use to move the pointer and select icons and options in menus but if you lose your mouse or it stops working, you don't have to stop working as well. You can use the keyboard instead, as follows:

- **To move the pointer**

Press one of the four cursor keys , ,  and .

The pointer will move in steps of about 1/8 inch. If the pointer doesn't respond, press the  key and then try again. Your PC will beep as you press  to tell you that the function of the cursor keys has changed.

If you want to move the pointer in smaller steps, hold down the  key at the same time as pressing the cursor key.

- **To 'click the mouse button'**

Press and quickly release the  key.



- **To 'double-click the mouse button'**

Press and quickly release the  key twice in quick succession.



- **To 'shift-click the mouse button'**

Press and quickly release the  button while holding down the  key.

- **To 'drag' an item, a window's size box or a window about the screen**

- 1) Move the pointer to the item or the title bar of the window you want to move.
- 2) Press and release the  key.
- 3) Move the pointer to the new position.
- 4) Press and release the  key.

- **To draw a 'rubber rectangle' on the screen (eg. to select a group of icons)**

- 1) Move the pointer to the top lefthand corner of the rectangle you want to draw.
- 2) Press and release the  key.
- 3) Press and release the  key.
- 4) Move the pointer to the bottom righthand corner of the rectangle.
- 5) Press and release the  key.

- **To select the 'principal' exit button from a Dialog box**

Press the  key.

PART III: USING MS-DOS COMMANDS

CONTENTS

1. <i>Introducing MS-DOS</i>	219
Starting to use MS-DOS	220
Using MS-DOS commands	222
More about the system prompt, command name, command tail	
When commands fail	225
2. <i>Overview of MS-DOS commands</i>	227
2.1 The tasks you can use MS-DOS for	227
Running programs; Organising your work; Processing your disks; Tailoring the AMSTRAD PC to your needs	
2.2 Some practice in using MS-DOS commands	229
Simple commands; Longer commands; Commands with options; Another drive, another directory	
3. <i>Conventions</i>	235
Standard placeholders	236
Structure of the reference chapters	237
4. <i>Running programs</i>	239
4.1 Running a program	241
4.1.1 Finding the files you want	241
4.1.2 Using files in a different directory	242
4.1.3 Running two-disk programs on a single-drive PC	246
4.1.4 Running the program	247

4.2 Shortcuts at the keyboard	249
4.2.1 Editing the command line	249
4.2.2 Stopping a program while it is running	251
4.2.3 Keeping a record of the work you do	251
4.2.4 Searching for files	252
4.3 Redirecting input and output	254
4.3.1 Redirecting the standard input	254
4.3.2 Redirecting the standard output	255
4.3.3 Piping output from one program to another	255
4.4 Setting up a sequence of commands	257
4.4.1 A simple Batch file	257
4.4.2 Making a Batch file more versatile	258
4.4.3 Using Batch files for more than one job	259
4.4.4 Interrupting a Batch process	260
4.4.5 Obeying a Batch file automatically	261
Commands	262 – 299

5. Organising your work **301**

5.1 Putting files into groups	302
5.1.1 Displaying the current pattern of directories	302
5.1.2 Adding a new directory	303
5.1.3 Removing a directory	304
5.2 Disk housekeeping	306
5.2.1 Making copies of files	306
5.2.2 Examining text files	308
5.2.3 Deleting files	309
5.2.4 Renaming files	309
5.2.5 Comparing files	310
5.2.6 Finding out how much room there is on a disk	310
5.3 Protecting your files	311
5.3.1 Making security copies	311
5.3.2 Controlling the creation of security copies	311
5.3.3 Protecting against accidental deletion	312
5.3.4 Monitoring when files are changed	312
Commands	314 – 346

6. <i>Processing disks</i>	347
6.1 Preparing new disks for use (Formatting)	347
6.2 Copying disks	348
6.3 Checking disks	349
6.4 Comparing disks	349
Commands	350 – 357
7. <i>Tailoring your PC to your needs</i>	359
7.1 Setting up your PC's input and output devices	359
Changing the roles of particular devices	
New equipment or settings	
7.2 Personalising your PC	363
7.3 Setting your PC's clock	364
Commands	365 – 378
8. <i>MS-DOS command summary</i>	379

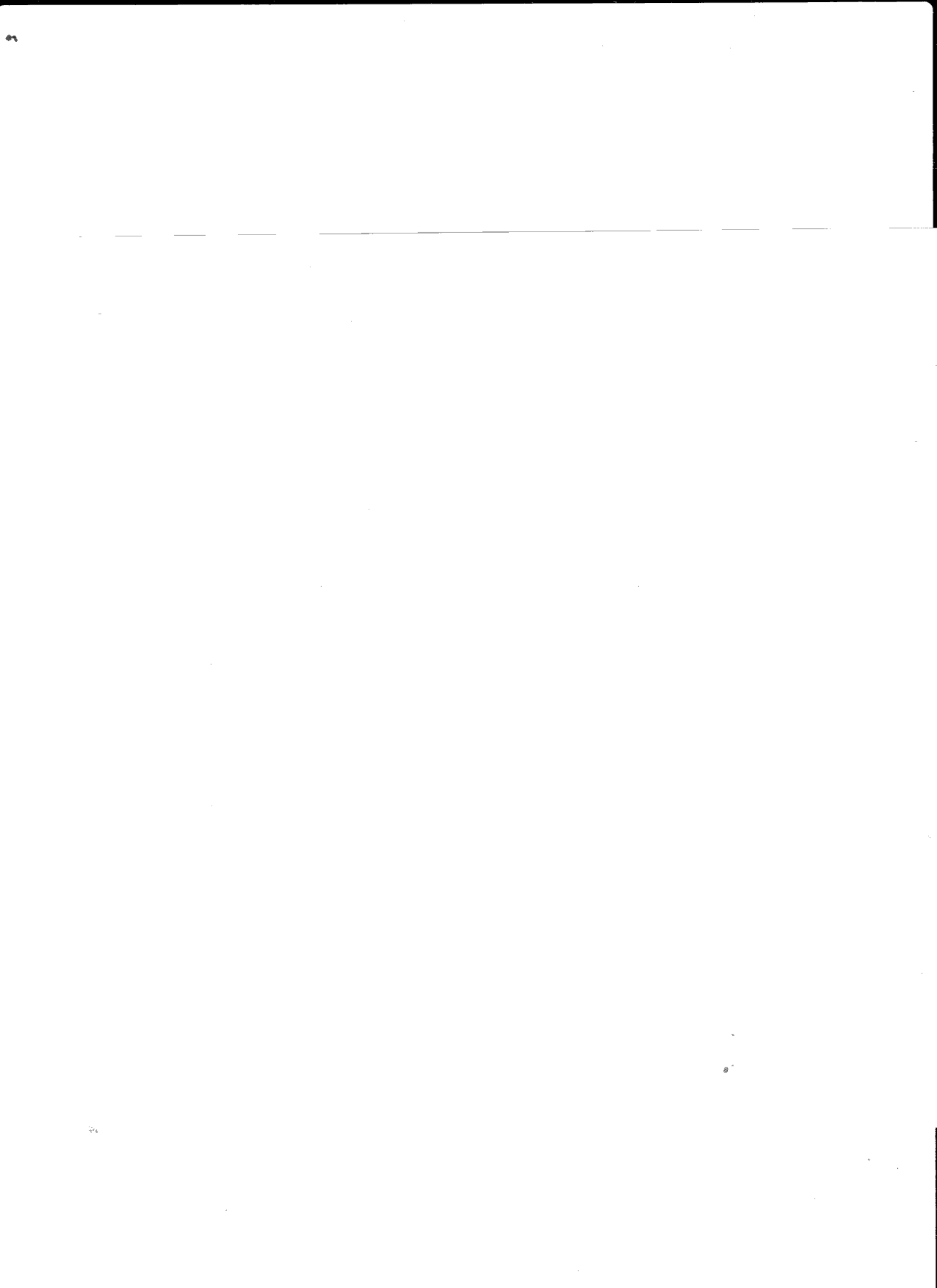

1. INTRODUCING MS-DOS

MS-DOS Version 3.2 is an operating system – that is, MS-DOS Version 3.2 is software that is used on the AMSTRAD PC to:

- **translate commands you type in into instructions that your PC's processor understands**
- **manage your program files and data files for you**
- **run programs for you**

In other words, it controls how the AMSTRAD PC behaves.

Without this software your PC can't respond to any instructions you try to give it. With it, the AMSTRAD PC is a powerful general purpose microcomputer.

MS-DOS makes the AMSTRAD PC work in very much the same way as PC-DOS, the operating system used on an IBM PC (which you can also use on the AMSTRAD PC if you want). As a result, programs written for the IBM PC can be run under MS-DOS. This automatically makes all the PC-DOS software (of which there is a large amount) available on the AMSTRAD PC.

To use the AMSTRAD PC, you need to be able to give instructions to the operating system. The GEM Desktop described in Part II of this manual lets you do this by using a mouse as a pointer and picking out the operations you want from menus. This part of the manual describes the way to do this by typing in commands – for use when you aren't running GEM software.

The instructions that MS-DOS understands are instructions to run some special programs called the MS-DOS commands. These commands let you:

- **Run programs**
Simple programs; Series of programs
- **Organise your work**
Create files; Put them into groups; Copy files; Display files; Rename files; Delete files; Protect files; Bring files up to date
- **Process disks**
Prepare new disks; Make duplicate copies of disks
- **Handle the AMSTRAD PC's input and output devices**
Change where input is taken from and where output is sent to; Use different input and output devices
- **Personalise the AMSTRAD PC and make use of the AMSTRAD PC's special features**
Personalise how information is displayed on the screen; set your PC's internal clock

Some of these commands are built into MS-DOS: these are called Internal commands. The rest are stored in files on your AMSTRAD PC disks: these are called External commands. Internal commands are always available for use: external commands have to be read into the PC's memory from the disk before the command can be carried out.

- > **FIRST-TIME USERS** > If you are a newcomer to computing, we suggest you turn back to the first part of this manual and read Chapter 1 before you go any further. This describes what files, directories, input and output devices, etc. are and how a computer uses these. Such details are the same whether you are using the GEM software or typing in commands to MS-DOS.

You will probably also find it helpful to spend some time getting used to handling disks and files from the GEM Desktop (as described in Part II) before coming back to this part of the manual.

Note: The description given here deals specifically with MS-DOS Version 3.2 commands, but you can also use this manual to tell you how to use commands of the same name in MS-DOS Version 3 and PC-DOS Version 3.1.

Starting to use MS-DOS

Note: If anything happens while you work through this chapter that isn't explained here, turn to Appendix VII 'Troubleshooting' and see if you can find out what has gone wrong. If in doubt, consult your dealer.

The steps to using MS-DOS commands are as follows:

● **If you haven't switched your PC on:**

1 Start with

- the mains plug out of the supply socket
- the power switch on the back of the Display in its OFF position (fully released)
- no disk in any floppy disk drive.

2 Plug the Display into the mains supply and then turn the machine on by pressing the power switch.

Your PC then goes through a built-in system check. If all is well, a message similar to the following will shortly appear on the screen.

```
AMSTRAD PC 640k (v3)
(c)1987 AMSTRAD plc
```

If you see the following message:

Check Keyboard and Mouse

clear everything off the keyboard and check that none of the keys are stuck down. Similarly, check that neither of the mouse buttons is stuck down. Finally, check that both the keyboard and the mouse are properly connected to the System Unit. The message will be erased shortly after you clear the problem.

3 Insert Disk 1 of your AMSTRAD PC disks (preferably, a copy of the supplied disk) in Drive A – the lefthand drive if you have two.

Insert the disk into the slot in your disk drive. If you have two disk drives, insert it into the slot of your lefthand disk drive. When the disk is fully inserted, close the drive by turning the door lock across the drive slot: this holds the disk in the drive.

Note that in the case of a Hard Disk PC there is no need to insert a Startup disk (unless you wish to override the operating system loaded automatically from Hard Disk).

Don't worry if the following message appears on your screen. It is just a reminder:

Insert a SYSTEM disk into Drive A
Then press any key

4 Press either the space bar or the Carriage Return key (↵).

You should now see the green indicator light on the drive go on and off a few times. When your PC is ready, it will be showing the following:

```
AMSTRAD PC 640k (v3)
(c)1987 AMSTRAD plc
```

possibly followed by details of the RAMDrive and the MOUSE driver. If, instead it asks you to enter the date, press [↵] – and press it again when you are asked to enter the time. The last thing to be displayed is an A>.

● **If you have already been using your PC:**

1 Hold down the [Ctrl] and [Alt] keys and press the [Del] key.

2 Insert Disk 1 of your AMSTRAD PC disks (preferably, a copy of the supplied disk) into Drive A – the lefthand disk drive if you have two.

You should now see the green indicator light on the drive go on and off a few times. When your PC is ready, it will be showing the following:

```
AMSTRAD PC 640k (v3)
(c)1987 AMSTRAD plc
```

possibly followed by details of the RAMDrive and the Mouse driver. If, instead it asks you to enter the date, press [↵] – and press it again when you are asked to enter the time. The last thing to be displayed is a C> or A>.

● **You can now start typing MS-DOS commands.**

The C> or A> is the MS-DOS system prompt, which tells you that MS-DOS is ready to receive a command. The oblong that follows the C> or A> is the cursor and its position marks where anything you type will appear on the screen.

Note: If you have a floppy disk system you will need Disk 1 again, whenever you want to use one of the MS-DOS external commands.

Using MS-DOS commands

You use MS-DOS by giving it instructions called command lines. These command lines each contain:

- **the name of the program to be run** – the command name
 - **the names of the files you want the program to process**
 - **any other information the program needs**
- } – the command tail

You use command lines like this to run programs you buy such as word processor programs and spreadsheets, programming languages such as BASIC, text editors for editing your file, computer games or advanced computing tools such as assemblers. You also use command lines like this to call up the MS-DOS commands that help you run other programs and organise data.

For example, to COPY a file called FILE.X to a file called NEWDATA.PQ, you would use the command line:

```
A>COPY FILE.X NEWDATA.PQ
```

The Command Tail, in this case the names of files you want to process
The Command Name, ie. the name of the program you want to run
The System Prompt

The **System Prompt** is put up on the screen by MS-DOS to show that it is ready to receive a command. The rest of the command line you type yourself. It automatically appears to the right of the system prompt.

What you type depends on the program you want to run or the command you want to use. The details are given by the program's or the command's **Form** or **Syntax**. The Form of each MS-DOS command is given in this manual as part of its detailed description in Chapters 4 - 7. The Form of the command lines you need to run any commercial programs you buy will be given in the programs' own user guides.

Within the command line you give all the information MS-DOS needs to do the job you want. In particular, you must remember to include details of where the program you want to run is stored (ie. in which drive and in which directory) and, similarly, details of where the files you want the program to work on are located. If you don't tell MS-DOS where to find these files it will assume that they are to be found in the default drive, among the files you are currently working on.

The location information you give is:

- **the drive**, if the file is not in the default drive
- **the path to the directory** if the file is not in the current directory of the drive (see Section 4.1)

If any of these terms seem strange, do go back and review Part I, Chapter 1 before continuing.

Command lines have to be typed correctly if the command is to work properly. You will need to pay attention to every detail of each command line: every comma, colon, semi-colon, space etc. has to be included exactly as described by the program's or the command's Form.

However, you can type characters in either upper or lower case or even a mixture of the two. For example, your PC will do exactly the same actions whether your command line is:

```
A>COPY FILE.X NEWDATA.PQ
or A>copy file.x newdata.pq
or A>COPY file.x newdata.PQ
```

Most mistakes will be picked up when MS-DOS starts to process the command line (see 'When commands fail', below), but there is always a chance that MS-DOS will do what you say, rather than what you want! If you spot a mistake while you are typing in the command line, use the **[Del]** key to rub out what you have typed back to the mistake and then type the remainder of the command line in again.

When you have finished typing the command line, you press the **[↵]** key. This sends your instruction to MS-DOS for processing. The program you specified in the command line is then run. When the program has finished, MS-DOS puts a fresh system prompt on the screen. It is then ready to process another instruction for you.

More about the System Prompt

The main job of the system prompt is to tell you that MS-DOS is ready to receive a new command. If there is a system prompt on the screen with the cursor to the right of it, you can type in your command.

The system prompt also tells you which drive is the current default drive. MS-DOS can be set up to handle up to 26 drives at the same time – though it is normally set up to handle five. It calls these drives Drive A, Drive B, ... Drive E. The default drive is the one it assumes you want to use unless you tell it otherwise. When the system prompt is A>, the default drive is Drive A – your floppy disk drive (or the lefthand disk drive if you have two). If you have two floppy disk drives, you might change the default drive to Drive B (the righthand disk drive); the system prompt would then become B>. (How to change the default drive is described in Chapter 4 'Running programs'.)

The system prompt described here is the standard MS-DOS system prompt. If you wish, you can set up a 'personalised' system prompt which does the same job but contains different information. How to do this is described in Chapter 7 'Tailoring your PC to your needs'.

More about the Command Name

The command name tells MS-DOS which command you want to use or which program you want to run. This could be:

- an MS-DOS internal command
- an MS-DOS external command (stored on the MS-DOS Startup and Utilities Disk)
- an MS-DOS or PC-DOS program; or
- a Batch file (see Section 4.4 'Setting up a sequence of commands')

You will be able to recognise which of your files contain programs you can run from their filetype. MS-DOS programs and PC-DOS programs (often described together as DOS programs) have the filetype COM or EXE (ie. names like MYPROG.COM or MYPROG.EXE) and Batch files have the filetype BAT (for example, MYBATCH.BAT).

The command name has two parts:

- first, the location of the file holding the program or the command
- second, the filename of the file

The command name never includes the filetype of a program or a command file.

The location part of the command name is only included when the command or program is not immediately available. MS-DOS internal commands are always available: the other programs that are immediately available are the MS-DOS external commands and other programs **in the group of files you are currently working on in your default drive.**

For all other commands and programs, you have to tell MS-DOS in which drive and/or in which directory to look for the program. For example, if you want to use the external command DISKCOPY which you have stored on the built-in disk (either a hard disk, if your system has one of these, or an area of your computer's memory that can be used as a disk), you would start your command line:

C:DISKCOPY...

If it were stored in a directory called COMMANDS on Drive C, you might start your command line:

C:\COMMANDS\DISKCOPY...

Note: The location part of the command name is often left out when the 'Form' or 'Syntax' of the command is given, making it up to you to remember to include this information if it is needed. Details of how to include the location in the command line are given in Section 4.1.

More about the Command Tail

The information a program needs in the command tail and the order this is given in depend on the program. It is all laid out in the 'Form' or 'Syntax' statement for the command line and must be followed exactly if the program is to work correctly.

The Form of the command line for each MS-DOS command is given in this manual in Chapters 4 - 7 where all the commands are described in detail. The form of the command lines you will need to run the commercial programs you buy will be given in the programs' own user guides.

The Form statement shows you how to give MS-DOS the details of the files you want the programs to process and it tells you how to specify the program options you want to take advantage of. The way it does this is through items like *d:*, *filename*, *parameter*, and *physical-device* written in a different style to the rest of the line. (In this manual, these are always written in an italic script.) These are known as placeholders and they show where you need to insert details of the actual job you want to do, for example the name of the file you want to copy or the name of the file you want to store the copy in.

For example

RENAME *old-name new-name*

tells you to type **RENAME**, followed by a space, followed by the old (ie. the current) name of the file you want to rename, followed by another space, and finally the new name you want to give the file. So if you wanted to rename the file **FILE.X** and call it **MYFILE.X1**, the command line you would type would be:

```
RENAME FILE.X MYFILE.X1
```

What you need to replace the placeholders with should be explained either in the notes describing the command line or in a general section covering the conventions used in the manual. There can also be parts of the command line that you can miss out if they are not appropriate. Details of the conventions used in this manual are given in Chapter 3 'Conventions'.

When commands fail

Commands fail because:

- you have made a typing error in the command line
- you haven't specified the location of a file correctly
- you haven't got enough memory space for the program to run
- you haven't got enough room on the disk to store the new files the program produces
- the file holding the program has been corrupted (or it never worked in the first place!)

You can usually tell why a command has failed from what appears on the screen.

- **If MS-DOS puts up the message 'Bad command or file name', it hasn't found the command, program or batch file you wanted to run.**

The commonest reason for this is that you mistyped the command name. For example, you might have typed **COYP** instead of **COPY**. The other possibility is that the program file isn't in the directory or directories MS-DOS searched. You may have misdirected MS-DOS, for example because you forgot which disk you had in the drive. Check where you told MS-DOS to look for the file.

- **If MS-DOS puts up a message like 'File not found' together with details of the file and a fresh system prompt, it hasn't found one of the files you asked it to process.**

Either you mistyped the filename or the filetype or the file isn't in the directory you specified. Check where you told MS-DOS to look for the file.

In both of these cases you can either retype the command line at the new system prompt or copy and then edit your previous command line. The keystrokes to help you do this are described in Section 4.2. When you have finished preparing your new command line, press the key.

- **If MS-DOS puts up some other message like 'Memory insufficient to run program' or 'Disk full', it has met some other problem in carrying out your command.**

Turn to Appendix VII 'Troubleshooting' where error messages like this are explained and then take whatever action is appropriate. You may, for example, need to erase some files you no longer need from the disk or change what you are trying to do.

If in doubt, consult your dealer.

-
- **If the screen goes blank or your PC generally seems 'dead', your program file may have been corrupted.**

Reset your PC (see Part I, Section 8.3) or, if you can't reset your machine, release the disk(s) in the drive(s), switch off and then work through the Startup procedure again (see Part I, Section 8.1). Then try running your program again. If you get exactly the same failure this time, try running your reserve copy of the program (if you have made one of these). If that fails too, consult your dealer.

Postscript

In principle, you now know enough about MS-DOS to run any well-documented DOS program.

If all you want to use your PC for is to run commercial programs, you could now just read Part I, Chapter 5 which describes how to select and run suitable software, in conjunction with the programs' own user guides.

But we would recommend you also read the following chapter - 'An overview of MS-DOS commands'. This will give you a broader understanding of what you can do when things go wrong. It will also enable you to get your programs working that much easier.

2. OVERVIEW OF MS-DOS COMMANDS

This chapter is split into two parts:

- A summary of each of the reference chapters
- A guided tour through some simple uses of MS-DOS commands

The idea is to give you a feeling for the sort of operations you can use MS-DOS commands for and to get you used to the idea of typing command lines.

When you start using MS-DOS in earnest, we expect you to refer to the relevant chapter for both background information on the sort of task you want to carry out and for details of the commands you need for a particular task. Each description of a command also includes examples for you to follow.

2.1 The tasks you can use MS-DOS for

Running programs

This chapter describes the primary job of your computer – to run programs for you. In particular, it describes ways to run programs more efficiently through:

- **Shortcuts at the keyboard**
 - Editing the previous command line to save typing
 - Stopping the program that is being run. Sometimes you can then make it continue where it left off
 - Keeping a record on your printer of what you have typed and the programs you have run
 - Extending the number of disks and directories MS-DOS will search automatically to find the program or data file you want
- **Redirecting input and output**

Programs usually take their input from the keyboard and send their output to the display screen. This section shows you how to

 - tell the program to take its input from a file or from a telephone link
 - tell the program to send its output to a file, or to a printer or down a modem link
 - link programs together so that the output of one program is the input of the next program in the chain
- **Setting up a sequence of programs**
 - to run one after another automatically
 - to be run whenever your PC is turned on

Organising your work

This chapter describes how to make and keep your files readily available for use by:

● **Putting your files into groups**

As you increase the number of files on a disk, you will find that they become much more manageable and more convenient to use if related files are grouped together. MS-DOS then lets you work on just a group at a time.

The first section of this chapter describes how to

- Start new groups
- Get rid of groups you no longer need

● **Disk housekeeping**

The selection of files you have on your disks and the way these files are grouped will frequently become out of date. You may well have files you no longer need taking up valuable space on your disk.

The commands in this section help you put this right by

- Creating new files
- Making copies of existing files
- Erasing files you no longer need
- Changing what files are called

● **Protecting important files**

Files are readily erased or overwritten. This section describes how to protect your most valuable files - programs you have bought, last year's accounts, etc. - against being erased or overwritten accidentally.

Processing your disks

Processing your disks covers:

● **Preparing new blank disks**

- Dividing up the blank disk into sections so that your PC can store and retrieve information from the disk. This process is called Formatting the disk.

● **Maintaining existing disks**

- Making duplicate copies of your disks so that you have a reserve or 'back-up' copy for use in case of accidents
- Checking that the data stored on a disk has not become corrupted by 'Verifying' the contents of the disk.

These tasks are fundamental to using floppy disks in your PC.

Tailoring the AMSTRAD PC to your needs

When you bought your AMSTRAD PC, it was set up to be used in a very conventional way – with the keyboard your main means of giving instructions and information (ie. input) to the computer and the display screen used by the computer to display (ie. output) information. The system prompt and the number of lines and characters in each page of information are among other details set up conventionally.

This chapter explains how to tailor your PC to your needs by:

- **Setting up Input and Output Devices**

Bring a printer or a communications link into play or change the details of how your current set of input and output devices work by:

- setting device parameters
- organising what information is sent where

- **Personalising your PC**

- by setting up a personalised system prompt
- by giving your disks names by which you can identify them

- **Setting your PC's internal clock**



- by setting the date
- by setting the time

You don't have to set the clock but if you do, the date and time MS-DOS automatically records with each file for you do actually tell you when the file was last changed. If you don't set the clock, the date and time recorded with each file can be very misleading.

2.2 Some practice in using MS-DOS commands

The rest of this introduction takes you through some simple uses of MS-DOS. Although you can just read it, we recommend you work through the instructions on your PC as it will get you used to using MS-DOS commands.

The sets of commands we will use are those for finding out about the files stored on your disks and those for keeping your files organised. These are described in Sections 4.1 and 5.2. We recommend that you look up the commands used in the reference sections as you work through this introduction. This will help you get used to the way commands are described in the reference chapters and so make these easier to use when you start using MS-DOS commands in earnest.

Note: In this section, we remind you to press the Carriage Return key  to send each command you type to MS-DOS by putting  at the end of each command line. The more advanced sections of this manual assume that you know to press  at the end of each command line.

Remember to type command lines only when the last thing displayed on the screen was a system prompt (eg. A>) with the cursor to its right.

Loading MS-DOS

Our guided tour starts by loading MS-DOS. If your PC is already set up to use MS-DOS commands, join the tour at 'Simple commands'.

Note: If anything happens while you work through this chapter that isn't explained here, turn to Appendix VII 'Troubleshooting' and see if you can find out what has gone wrong. If in doubt, consult your dealer.

● **If you haven't switched your PC on:**

1 Start with

- the mains plug out of the supply socket
- the power switch on the back of the Display in its OFF position (fully released)
- no disk in any floppy disk drive.

2 Plug the Display into the mains supply and then turn the machine on by pressing the power switch.

Your PC then goes through a built-in system check. If all is well, a message similar to the following will shortly appear on the screen.

```
AMSTRAD PC 640k (v3)
(c)1987 AMSTRAD plc
```

If you see the following message:

Check Keyboard and Mouse

clear everything off the keyboard and check that none of the keys are stuck down. Similarly, check that neither of the mouse buttons is stuck down. Finally, check that both the keyboard and the mouse are properly connected to the System Unit. The message will be erased shortly after you clear the problem.

3 Insert Disk 1 of your AMSTRAD PC disks (preferably, a copy of the supplied disk) in Drive A – the lefthand drive if you have two.

Insert the disk into the slot in your disk drive. If you have two disk drives, insert it into the slot of your lefthand disk drive. When the disk is fully inserted, close the drive by turning the door lock across the drive slot: this holds the disk in the drive.

Don't worry if the following message appears on your screen. It is just a reminder:

```
Insert a SYSTEM disk into Drive A
Then press any key
```

Note that in the case of a Hard Disk PC there is no need to insert a Startup disk (unless you wish to override the operating system loaded automatically from the Hard Disk).

4 Press either the space bar or the Carriage Return key (↵).

You should now see the green indicator light on the drive go on and off a few times. When your PC is ready, it will be showing the following:

```
AMSTRAD PC 640k (v3)
(c)1987 AMSTRAD plc
```

possibly followed by details of the RAMDrive and the MOUSE driver. If, instead it asks you to enter the date, press ↵ – and press it again when you are asked to enter the time. The last thing to be displayed is a C> or A>.

● **If you have already been using your PC:**

1 Hold down the [Ctrl] and [Alt] keys and press the [Del] key.

2 Insert Disk 1 of your AMSTRAD PC disks (preferably, a copy of the supplied disk) into Drive A – the lefthand disk drive if you have two.

You should now see the green indicator light on the drive go on and off a few times. When your PC is ready, it will be showing the following:

```
AMSTRAD PC 640k (v3)
(c)1987 AMSTRAD plc
```

possibly followed by details of the RAMDrive and the MOUSE driver. If, instead it asks you to enter the date, press ↵ – and press it again when you are asked to enter the time. The last thing to be displayed is C> or A>.

Simple commands

MS-DOS commands are set up so that unless you tell them otherwise, they will work with the files in the default directory – that is, the directory you are currently working on. On Startup or immediately after you have reset your PC, the default directory is the main or 'Root' directory on Drive A.

So we will start with some command lines that will work with just this directory and we will use Internal rather than External commands because we don't have to take any special steps to ensure that these are available for use, even when you haven't got the MS-DOS Start-up and Utilities Disk in the drive. (You will, however, have to have a copy of Disk 1 in a drive before you can use any of the MS-DOS External commands.)

Often, the first thing you will want to do is to find out what files are held in this directory. (The reference section that describes this is Section 4.1.) The command to use to display a directory is the DIR command and to display all the files in the default directory, you just type:

```
DIR ↵
```

You can type DIR in either upper or lower case letters, or a mixture of the two: it makes no difference to the result. Up on your screen will come something like this:

```
A>dir

Volume in drive A has no label
Directory of A:\

COMMAND  COM      25612  21/05/86  12:31a
DISKCOPY EXE     3836  21/05/86  12:31a
DOODLE   APP     12512  22/05/86  11:51a
DOODLE   RSC     4046  22/05/86  11:51a
GEMSYS   <DIR>    27/05/86  14:31a
GEMDESK  <DIR>    28/05/86  15:12a
BASIC2   <DIR>    28/06/86  12:00a
GEMAPPS  <DIR>    30/06/86  14:56a

         4 File(s)      140640 bytes free
```

This gives you the names of all the files in the default directory.

DIR can also be used to give information about particular files by adding a 'command tail' to our original file. For example,

```
DIR COMMAND.COM 
```

gives you the standard information but just about the file COMMAND.COM. You might use a command like this to check whether a particular file is in the default directory. If the file isn't found, MS-DOS will display the message:

File not found

DIR is one of a small group of commands which will process a number of files at a time if you wish. You tell the command to do this by putting a special sort of file name into the command tail - one that includes 'Wildcard' characters. These wildcard characters represent any valid character or group of characters. The special file name is used as a 'template' with which the name of each of the files in the directory is compared. Only if the name matches the template will information on the file be displayed.

The special 'Wildcard' characters are * and ?. An asterisk in the template represents any valid group of characters that can appear in that position in the template. A question mark only represents a single character.

So, for example, if you wanted to list all the files with the filetype EXE, you would use the template *.EXE and the command:

```
DIR *.EXE 
```

And if you wanted to list all the files, you might type:

```
DIR *.* 
```

In fact you would just type DIR because DIR is a recognised shorthand for DIR *.*. Similarly, you probably wouldn't type DIR *.EXE to tell MS-DOS to list all files with the filetype EXE because you can just type DIR .EXE

If you wanted to list all the files with the filetype EXE whose filenames started DISK, you might use the template D*.EXE and the command:

```
DIR D*.EXE 
```

This will, however, give you all the files that match this template, ie. every file that has a filename starting with the letter D – not just the ones with the filenames starting DISK – as you will see if you try this out.

Longer commands

Some commands need the name of more than one file in the command tail. For example, when you want to make a copy of one of your existing files, you need to tell MS-DOS both the name of the file you want to copy (known as the 'Source') and the name you are going to give the copy you create (known as the 'Destination'). For example, the command line to make a copy of the file AUTOEXEC.BAT (the Source) and store it as the file MYBAT.BAT (the Destination) is:

```
COPY AUTOEXEC.BAT MYBAT.BAT 
```

The Source file is not changed in any way by being copied.

As you don't need the file MYBAT.BAT, you might as well delete it with the command:

```
DEL MYBAT.BAT 
```

Commands with options

The commands we have typed so far have all been as simple as possible. You can get commands to do more for you by using command options. These options are listed in the command specifications in slanting brackets to show that you don't have to include these every time you use the command.

The options are often represented by a slash followed by a letter. For example, the DIR command has a /W option that prints the names of the files in a directory five to a line, rather than in a long list. This way of displaying the directory uses command lines like:

```
DIR/W            - the whole directory  
DIR .EXE/W       - all the files with the filetype EXE
```

Another possibility with the DIR command is to use the /P option to make MS-DOS pause at the end of each screenful so that information isn't scrolled off the top of the screen before you have a chance to read it. You can use this option on its own or you can use both options at once, by typing:

```
DIR/W/P   
or DIR/P/W 
```

The order in which you list the extra options usually doesn't matter: if it does matter, this will be emphasised in the description of the command.

Another drive, another directory

So far in this tour, we haven't looked outside the default directory. The final commands we will look at in this section show what you need to add in when you want to process a file that isn't in the default directory.

A very simple example of this is using the DIR command to see if a particular file is in the current directory on Drive C (the built-in disk), without first changing the default drive to Drive C. If you type:

```
DIR C:COMMAND.COM ↵
```

the AMSTRAD PC will display similar details to those displayed if you typed:

```
DIR COMMAND.COM ↵
```

the only difference being that instead of giving details of a file in the current directory on the default drive, the AMSTRAD PC gives details of a file called COMMAND.COM in the current directory on Drive C (if such a file exists).

To use files which aren't in the current directory, you have to include details of how to get to this directory. For example, suppose the file you want details of is called GEM2.BAT and it is stored in a directory called GEMSTART that branches off the Root directory on Drive A.

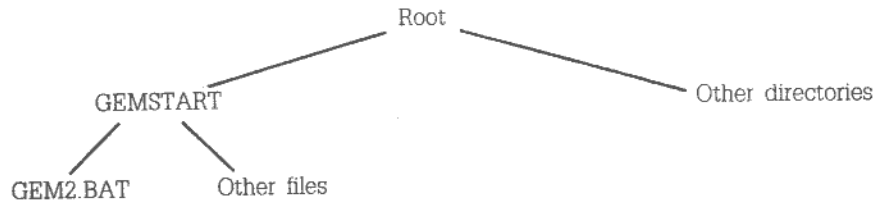

The path to the file is therefore: Root → GEMSTART → GEM2.BAT which you write as \GEMSTART\GEM2.BAT (the first backslash telling MS-DOS to start the path from the Root directory). Drive A is the default drive, so your DIR command line becomes:

```
DIR \GEMSTART\GEM2.BAT ↵
```

If Drive A hadn't been the default drive, this command line would have been:

```
DIR A:\GEMSTART\GEM2.BAT ↵
```

Postscript

This brief tour should have given you the flavour of how you use MS-DOS commands to carry out tasks for you. In the rest of this part of the manual, we describe the tasks and the commands you will need to use in detail.

3. CONVENTIONS

The following reference chapters make great use of placeholders to describe the form of the various command lines. This means that where you should put the actual name of, say, a file or a drive, we have put a brief description of the item printed in *italic* (ie. slanted) text - with hyphens between the words if more than one word is used to describe a single item.

For example, if you want the command to process a file called MYFILE.TXT, you should put **MYFILE** where we have put *filename* and **TXT** where we have put *filetype*.

Most of the placeholders are explained alongside the command itself but the most common ones are explained in the table below.

In addition, optional parts of the command line are surrounded by slanting square brackets: these parts may be left out altogether.

For example:

DATE [*dd-mm-yy*]

means that depending on the precise details of what you want to do, you either type:

DATE *dd-mm-yy*

or just:

DATE

A special example of this is [****] where this precedes *path*. If your chosen path starts at the root directory on the drive, you should include the backslash but if it starts at the current directory, you should leave the backslash out. (For further details, see Section 4.2.)

Anything not printed in *italic* must be typed in exactly as shown.

If some section of the command line can be included once or included many times, the placeholder will be given twice, followed the second time by ...

For example:

PATH [*\path*]; [*\path...*]

is used to represent any of

PATH *\path*

PATH [*\path*]; [*\path*]

PATH [*\path*]; [*\path*]; [*\path*]

etc.

Another convention is that where you have to choose just one out of a number of options, the options are written out in full but they are separated by solid vertical lines. For example:

ON|OFF

means type in either **ON** or **OFF** but not both. Do not type the |.

Take care to separate the items exactly as specified in the description of the command line. If this gives a single space or a comma between two items within the command line, then you must put one or more spaces or a comma between these two items.

Whenever you are not sure how to interpret the Form statement for a particular command, study the examples given alongside the command. These should clear up any uncertainty for you.

A further convention used in this manual is to represent 'Control codes' (that is, the special codes that control, for example, clearing the screen) as *Ctrl-character*. Some of the function keys on the keyboard may be set up to produce these codes but you can always produce them by holding down the **Ctrl** key and pressing the appropriate character key. When a Control code is displayed on the screen, it will be shown as *^ character*.

Standard placeholders

<i>command</i>	a complete command line, here incorporated in another command line
<i>d</i>	the drive holding the file you want to use represented as a letter. Often followed by a colon: for example, <i>d:</i> can be replaced by A: , B: , C: or ...
<i>destination</i>	the name of the file you want the copy to be stored in, written as <i>filename.filetype</i> (see below), or the name of a logical device you want the contents of a file to be sent to. (See Section 5.2.)
<i>device</i>	the name MS-DOS recognises for an input or output device attached to your PC. (See Section 7.1.)
<i>filename</i>	the first part of a file's name. For example, if the file's name is MYFILE.TXT , then the <i>filename</i> is MYFILE
<i>filetype</i>	the second part of a file's name. For example, if the file's name is MYFILE.TXT , then the <i>filetype</i> is TXT
<i>n</i>	a number. Details of the range of numbers that can be used will be given in the description of the command
<i>path</i>	the full details of the path from either the current directory or the root directory on the drive to the directory you want to work with, starting with the name of the first directory away from your starting point and finishing with the name of the directory you want to work with. The different directory names should be separated by single backslashes. For example, the <i>path</i> between the root directory and a directory called SUBDIR1 might be DIR1\SUBDIR1 (See Section 4.2.)
<i>source</i>	the name of a file you want to copy written as <i>filename.filetype</i> (see above) or of a logical device from which you want to take information and store it in a file. (See Section 5.2.)
<i>source-drive</i>	the drive holding the disk you want to copy, written as <i>d:</i> (see above).

<i>string</i>	a string of characters or a parameter that has been set to a string of characters
<i>target-drive</i>	the drive holding the disk you want to store the copy on, written as <i>d:</i> (see above).

Structure of the reference chapters

The reference chapters each deal with a different aspect of using your computer:

- **running programs**
- **organising your work**
- **processing disks**
- **tailoring your PC to your needs**

To make it easier for you to find the information and the help you need, each chapter has been given the same structure:

- 1 A general introduction to the chapter, giving details of the sections it contains.**
- 2 Sections dealing with specific aspects of the tasks, each major section starting on a new page.**
- 3 Details of all the commands involved in this area of work, listed in alphabetical order.**

The descriptive sections describe how to set about achieving the result you require and tell you about the commands you will need to use. The details of each command include full information on how the command should be used and on the command lines you will need, alongside examples showing the command's use in practice.

In the early stages, you will need to look first at the descriptive section to discover which command to use and then at the details of the command to find out the command line you need to type. Most of the commands it refers to will be detailed at the end of the same chapter, but occasionally you will be referred to another chapter for full details of the command.

Later, you will probably rely most on the detailed command information, with only occasional references back to the descriptive introductions. To identify the part of the description you need to help you use a particular command, either look in the index for the page number or scan the description for the name of the command written in the margin. For example, to find where the ASSIGN command is described, scan the margin for:

> **ASSIGN** >

Vertical text or markings on the left side of the page, possibly a page number or header.

4. RUNNING PROGRAMS

The primary job of your computer is to run programs for you. These programs can be 'application' programs you buy from your computer dealer, programming tools such as programming languages or assemblers, or the MS-DOS commands described in this manual.

You can recognise a file that contains a program you can run from its filetype:

- an 'application' program you can run will have the filetype COM or EXE
- a MS-DOS command is either built into MS-DOS or stored in a file with the filetype COM

(Remember: Internal commands are always available, but External commands can only be used if they are stored on a disk in one of your drives and MS-DOS is told where to look for them.)

In Part I, Chapter 5 of this manual, we described the essential steps in running a program on your AMSTRAD PC, both from the GEM Desktop and through an MS-DOS command line:

- selecting a suitable program
- finding out the information you need from the program's own user guide
- finally, setting the program running

In this chapter, we look at the additional facilities that MS-DOS provides.

Section 4.1 describes the fundamental process of running a program - locating the program you want to run and the data files you want it to process, making these files available so that the program runs efficiently, and finally typing in the command line that starts the program running.

Section 4.2 describes some shortcuts you can take at the keyboard.

- Editing the previous command line to save typing
- Stopping the program that is being run. Sometimes you can then make it continue where it left off
- Keeping a record on your printer of what you have typed and the programs you have run
- Extending the number of disks and directories MS-DOS will search automatically to find the program or data file you want

Programs are usually designed assuming that you will type in any additional information and instructions it needs at the keyboard. They are often also set up to send any information they generate to the monitor screen. Section 4.3 shows you how to

- tell a program to take its input from a file or from a telephone link
- tell a program to send its output to a file, or to a printer or down a telephone link

- link programs together so that the output of one program is the input of the next program in the chain

without changing the programs themselves in any way.

It also describes three special programs known as filters that take the output from other programs and process it.

Section 4.4 describes how to ease the burden of running the same series of programs repeatedly by telling MS-DOS the details of the sequence of programs once. On future occasions, you can type in one command line and MS-DOS will run the programs one after another automatically. A special case of this is a series of programs which you can arrange for your PC to run whenever it is turned on.

When you buy programs for your AMSTRAD PC to run under the MS-DOS operating system, remember you need to choose ones that are:

- **stored on 5¼ inch floppy disks**
- **designed to run under either the MS-DOS or the PC-DOS operating system**

> **VER** > In a few cases, you may need to know which version of MS-DOS you are using in order to be sure that the program will run on your PC. You can readily find this out by using the VER command.

Programs supplied with your AMSTRAD PC and many commercial programs can be run simply by typing in the appropriate command line and they will work perfectly. Other programs will run but won't always produce quite the results you expect because they don't control the screen properly or they don't respond correctly to what you type. Such programs need to be 'installed' before you use them. How to go about installing a program is described in Appendix I.

It is important to know what a directory is to understand the commands covered in this chapter. If you aren't certain you know, read Part I, Chapter 1 'Fundamentals of computing' before you use the commands.

4.1 RUNNING A PROGRAM

Before you run any program, you need to know which disk files you will need both to start the program running and while it is running. You also need to know how you are going to ensure that these files are found by MS-DOS when they are needed.

Usually (but not always) the program's own user guide will tell you which files you need and your job is simply to ensure that all the relevant files are on a disk in one of your drives and that you can tell MS-DOS through the program where to look for the files.

This section covers:

- **finding the files you want to use by listing sections of DOS directories**
- **accessing files from different directories**
- **and finally, running the program**

- Note:**
- (i) If the program you want to use wasn't specifically intended for use on the AMSTRAD PC, you may well be able to run the program but the way the results are displayed could be not quite right. Such a program may need installing for use on your PC. How to go about this is described in Appendix I.
 - (ii) Always remember to check out whether you can make a duplicate copy of the programs you buy before using them. If possible, you should always use a copy and keep the original disks safely stored away, for use solely to make further copies as and when these are needed.
 - (iii) There is advice in Appendix I on how to prepare disks holding only the programs and external commands you need while you are using a particular application (for example, your word processor or your spreadsheet).

4.1.1 Finding the files you want

It is always advisable before running any program or using any command to check where the files you want to use are located. The information in a program's user guide, for example, may not always tell you the right directory for a file – particularly if this guide wasn't prepared specifically for the AMSTRAD PC. Typically, you will need to find out

- whether a certain group of files is stored in a particular directory
- whether a certain file is stored in a particular directory

You may also want to know details about particular files or groups of files, such as:

- how large are they?
- are they protected in any way?
- when were they last edited?

> **DIR** > This information is obtained by displaying sections of the directory with the DIR command.

Telling MS-DOS which files you want information about comes in two parts:

- telling it which directory you want information from
- specifying the names of the files within the directory that you want information about.

You specify a directory by giving the drive it is on and the path to the directory. (How to do this is described in Section 4.1.2 below.) If you don't specify a directory, your PC displays information about the default directory.

You specify the files you want by giving the file template that covers all their names. (A file template is a special type of file name that matches a number of possible file names by including the wildcard characters * and ? (see Part I, Section 8.5).) If you don't specify which files you want, you get information about all the files in the directory.

The amount of information that is displayed when you use the DIR command depends on which command option you select. One option is to display just the filenames and filetypes of the files in the directory. This is often the only information you need and it is displayed compactly with details of five files on each line. If you don't specify a command option, MS-DOS gives one line of the display to each file and shows the size of the file in bytes (1024 bytes - which can also be written as 1 kilobyte or 1K or 1Kbyte - is approximately 1000 characters) and when it was last changed. The time information can be useful if, for example, you wanted to check whether you brought a particular file up to date the last time you used your PC.

4.1.2 Using files in a different directory

Files are organised into directories which are themselves organised into a 'tree-like' structure. MS-DOS only searches or stores files in one directory at a time because this is quick and effective. You will rarely want to process files from different directories at the same time.

Unless you tell it otherwise, the directory MS-DOS uses on a particular drive is whichever directory has been designated the Current Directory.

However, this means you need to know how to direct MS-DOS to a different directory:

- to use a particular file from a different directory.
- to change the current directory on the drive, for example if the command or program you want to use can only process files in the current directory

One of the first things you should find out about a program or command is whether it needs any files to be in a current directory.

The key to using files from a different directory is the 'Path' either from the current directory or the root directory on the drive.

The Path

A 'Path' directs MS-DOS to the directory you want to use by giving it a route through the directory tree. The route is essentially just a list of directory names.

The starting point for the path is always:

- either** the root directory on the drive
- or** the directory you are currently working with on the drive *

You can use the path from the root directory regardless of which directory you are currently working with.

Suppose, for example, that you knew that the structure of directories on the disk was:

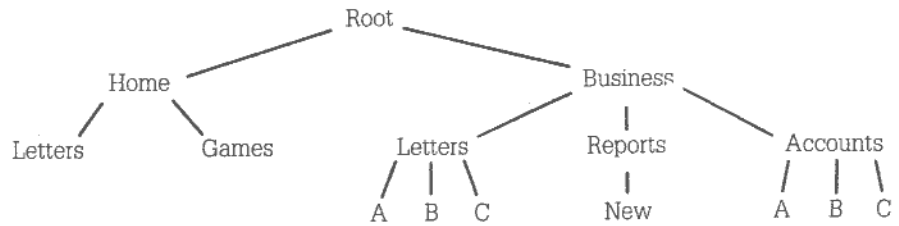

Paths from the Root directory

To work out the path you need, you start at the Root directory and list all the names on the way to the directory you want (including the name of this directory). The path is these names, written down in order and separated by backslashes (\).

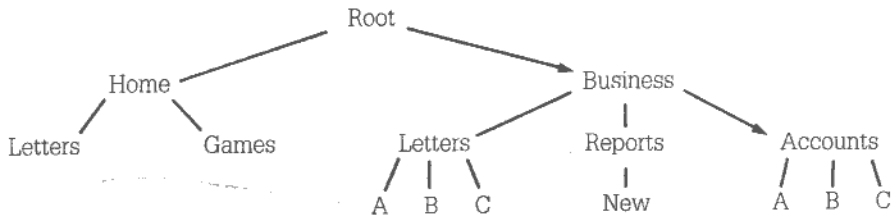

For example, to direct the operating system to the 'Accounts' directory, the names on the way are:

'Business' and 'Accounts'

and so the path is:

BUSINESS\ACCOUNTS

When you come to use this path, for example to specify a file in the directory, you precede it by a backslash (to tell the operating system that the path starts at the Root directory). If you are specifying a file, you put another backslash at the end of the path, to separate the path from the file name that immediately follows it.

For example, to specify a file called NEW.A in the Accounts directory, you would write:

\BUSINESS\ACCOUNTS\NEW.A

Paths from the current directory

To work out the path you need, you start at the current directory and, working up or down the tree as necessary, list all the names on the way to the directory you want (including the name of this directory). The path is these names, written down in order and separated by backslashes (\).

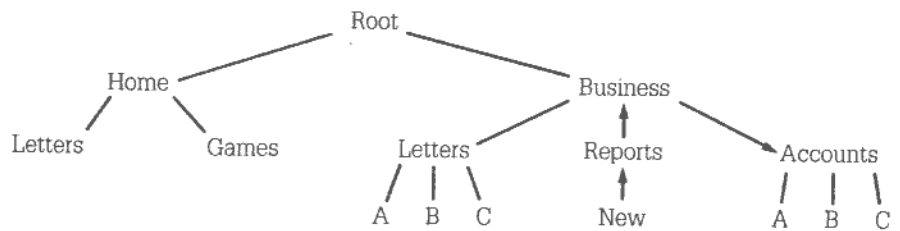

For example, suppose the current directory is 'New'. To direct the operating system to the 'Accounts' directory, the names on the way are:

'Reports', 'Business' and 'Accounts'

However, 'Reports' is the Parent directory of 'New' and 'Business' is the Parent directory of 'Reports', and there is a special way of writing Parent which is ..

So the path you would write is:

`..\..\ACCOUNTS`

When you come to use this path to specify a file in the directory, you would put a backslash at the end of the path, to separate the path from the file name that immediately follows it. **You would not put a backslash at the beginning of the path.**

For example, to specify a file called NEW.A in the Accounts directory, you would write:

`..\..\ACCOUNTS\NEW.A`

Changing the current directory

The current directory on a drive is the directory MS-DOS assumes you want to work on if you don't specify which directory you want to use. It can be any of the directories on the drive. When you first use a drive or when you reset it, the root directory is automatically the current directory.

If the directory structure is like this:

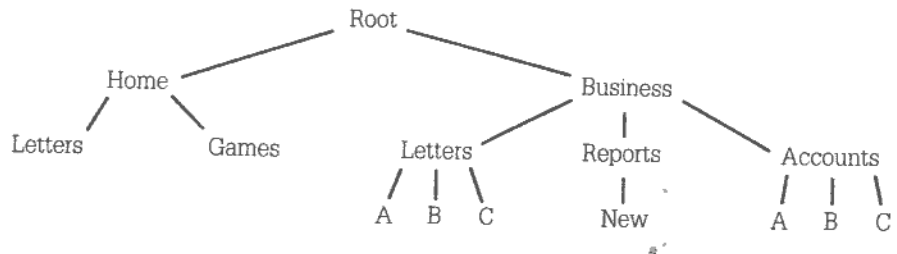

the current directory on this drive might be Business Letters to Company A (ie. \BUSINESS\LETTERS\A). If you prepare a new letter, it will automatically be stored with all your earlier letters to this company.

> **CHDIR** > To change which directory is automatically used on any drive or to see which the current directory is, use the CHDIR ('Change directory') command.

Note: If you want a particular directory to become the default directory - ie. the directory searched when you ask for a file by just its filename - you have to do two things:

- (i) Use CHDIR to make this directory the current directory on the drive
- (ii) Make the drive the default drive by typing a command line made up of the drive letter for the new default drive followed by a colon (:). For example, to change the default drive to Drive C (the built-in disk), you should type:

C: [←]

Having more than one current directory on a disk

The current directory gives you an efficient way of working on just the files in one directory on a particular drive. However, there may be a few occasions when you would like two or more directories on the same disk to behave as current directories.

There are two possible sets of circumstances:

- running a suite of programs when the program files and MS-DOS commands the programs use aren't necessarily all in the same directory as the data files
- using commands or programs that only work with files in a current directory

The first of these cases is handled by MS-DOS's file searching facilities (see Section 4.2). The second is handled by treating the directories as if they were on separate drives.

>**SUBST**> A directory is made to appear on a separate drive by assigning a drive letter to the directory. This is done with the SUBST command. You simply invent a drive that your PC doesn't already have a meaning for, for example Drive N, Drive O or Drive P. (The AMSTRAD PC initially has meanings only for Drives A...E.)

For example, suppose the directory structure was like this:

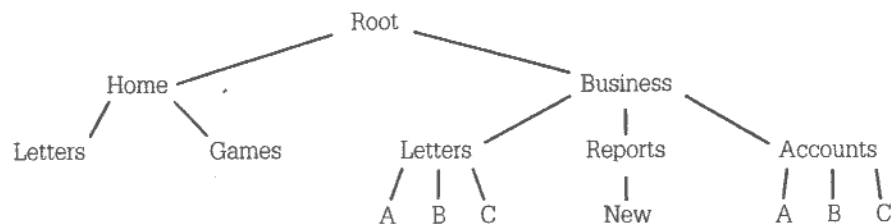

If you wanted to use a program that cannot handle paths to process files from both the 'Accounts' directory and the 'Reports' directory, you would make, say, 'Accounts' the current directory on the real drive and assign 'Reports' to your imaginary drive - say, Drive N. 'Reports' is then automatically made the current directory on Drive N. When you come to use your program to process, for example, REPORT.85 in the 'Reports' directory, you can now give directions that the program can handle, ie.:

N:REPORT.85

The directory assigned to the imaginary drive acts as the root directory on that drive. If this directory has any Child directories, you can use paths on the imaginary drive to work with the child directories just as you would with one of the standard drives. However, you cannot access its parent directory from the imaginary drive.

Coping with any assumptions your program makes

Any program you run may expect the files it needs to be on a particular drive. For example, it may assume that these files will be on your Drive B disk when in fact you have put the files alongside the program on your Drive A disk. It may not always be possible or practical to move the files so that they are on Drive B.

- > **ASSIGN** > The solution, provided none of the files the program wants are on Drive B, is to tell MS-DOS to route any request for a file from Drive B to Drive A. This is done with the ASSIGN command. However, don't use the ASSIGN command too freely: while this assignment is in force, no file on the disk in Drive B can be used because all instructions to look for a file on Drive B will be diverted to Drive A.
- > **JOIN** > Another problem you may meet is that programs and procedures you have established have built into them the assumption that certain files are in a certain directory on a particular disk when in fact there is no longer room for these files on this disk. For example, suppose you need to move all the files in the 'Business' directory onto another disk.

Rather than change your programs and procedures, you can instead just leave an empty 'Business' directory on this disk and then tell MS-DOS that whenever you ask for files from this directory, it should look for them in a different drive. The command that sets this up for you is the JOIN command.

4.1.3 Running two-disk programs on a single-drive PC

A number of programs (and commands) work with two floppy disks and the description of how to use these programs is often geared towards systems with two disk drives. If you have a single-drive PC, you are not excluded from using these programs and commands: indeed you use exactly the same command line.

This works because MS-DOS associates both of the labels Drive A and Drive B with your single disk drive. In particular, it associates Drive A with one disk and Drive B with a different disk. When MS-DOS needs the Drive A disk, it puts a message on the screen asking you to release the current disk and insert the 'Drive A' disk in the drive; when it needs the Drive B disk, it puts up a message asking you to release the current disk and insert the 'Drive B' disk in the drive. If you remember which disk is associated with which drive, you can't go wrong.

What may surprise you is that MS-DOS will in some circumstances ask, for example, for the disk for Drive A when you know that this disk is already in the drive. This happens because MS-DOS last used the drive as Drive B and it doesn't know that the disk in the drive isn't the Drive B disk. Just press a character key (eg. the Space bar).

Note: The system prompt tells you the current default drive. It does not tell you which drive MS-DOS currently regards your floppy disk drive as.

4.1.4 Running the program

Once you have:

- the disks you need in your disk drive(s)
 - the current directories you need on all your drives
 - the paths to any other directories worked out
 - a fresh MS-DOS system prompt on the screen (with the cursor flashing beside it)
- you are ready to run your program.

> **SET** > (A few programs may additionally require certain parameters to be set up in advance, which are used to specify the Environment the program works in. For example, the program may work differently depending on the current size of your PC's RAM disk. If this is the case, full details should be given in the program's own user guide. Some of these parameters are set up by specific MS-DOS commands; the others are set by using the SET command.)



Programs are run by typing in a command line made up of the command name (the name of the program you want to run) and the command tail (ie. the other details the program needs so that it carries out the job you want), and then pressing the  key.

The command line you need to type will either be given precisely in the documentation about the program or it will be given through a **Form** or **Syntax** statement which shows you how to include the information you want in the command tail. Read the documentation carefully to find out what details you need to type in instead of the placeholders in the Form or Syntax statement. The meaning of each placeholder should be either explained alongside the Syntax statement or in some general description of the conventions used in the user guide, like the one given in this manual in Chapter 3.

In addition, you may have to include details of the location of the program itself if this is neither built into MS-DOS or in the current directory on the default drive (the drive with the letter shown in the current system prompt) or in a directory automatically searched by MS-DOS (see Section 4.2.4). You will need to precede the command name with:

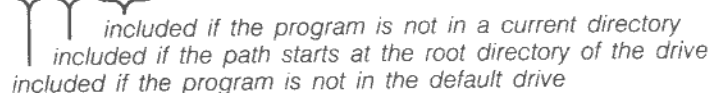
[d:][\][path]



For your program to work, the command line has to be exactly right so take care in typing this in. If you make a typing mistake, use the  key to rub out characters and then type the line in again. When you are sure the line is as you want, press the  key.

While the program is running, you may be able to move the mouse instead of pressing the cursor keys and to use the mouse buttons to produce certain effects - depending on the program you are running. If you are interested in making use of this (or you want to turn this feature off), turn to Appendix I where further details are given.

If your program fails in some way, see if you can work out what has happened and how to stop it failing again either from the program's own user guide or from Appendix VII. This covers troubleshooting a wide range of problems. If this doesn't solve your problems for you, seek the advice of your dealer.

Note: There are two other MS-DOS commands you may find helpful when you are running application programs:

> **CLS** >
> **VERIFY** >

CLS which clears the screen and puts a fresh system prompt in the top lefthand corner

VERIFY which instructs MS-DOS to confirm every time it writes data to a disk that this data can be read back, for example by checking that there are no bad sectors

4.2 SHORTCUTS AT THE KEYBOARD

4.2.1 Editing the command line

When you make a mistake or change your mind about the command or program you want to run before you press the **[↵]** key, you can always use the **[<Del]** key to rub out characters and then type in the rest of the line again.

Once your command has failed because of some small error, you might think that you have to type in the whole command line again. However, MS-DOS automatically stores your command line and, by pressing certain keys, you can build parts of the stored line into a new command line.

As you do this, you need to imagine a cursor moving through the stored command line dividing the command line into a section you have 'used' and a section that still remains for you to use. This cursor moves 'forwards' through the line:

- every time you copy characters from the stored line into your new line
- every time you tell MS-DOS to skip over characters in the stored line, and
- every time you type fresh characters without telling MS-DOS that you want to insert these.

It also moves 'backwards' if you delete any characters from the line.

The keys you want are as follows:

[F1] or [→]	Add the next character from the stored line.
[F2] character (ie. press [F2] and then a character key)	Add everything in the stored command line between the current position of the cursor and the given character. The character itself is not added to the new line.
[F3]	Add all the characters in the stored command line to the right of the cursor.
[F4] character (ie. press [F4] and then a character key)	Add the given character and everything in the stored command line to the right of this character.
[Ins]	Insert the following characters into the new command line without moving the cursor through the stored command line. If you don't press the [ins] key, this cursor will move forward one position for each character you type. Press [ins] again after you have typed the last character you want to insert.
[<Del] or [←]	Delete from the new command line the character to the left of the cursor. The cursor in the stored line also moves back one character.

Esc

Abandon the current new command line and start again working with the old stored line. MS-DOS places a \ at the end of the line you have abandoned and gives you a new line to work on.

F5

Replace the stored command line with the command line you have created so far and then start again working with this new stored line. MS-DOS places a @ at the end of the line you have stored and gives you a new line to work on. (For use when you notice that you made a mistake back near the beginning of the new command line but, naturally, you want to save your changes since then.)

←

Send the new line to MS-DOS for processing. It also replaces the stored command line with this new line.

For example, suppose that your last command was:

```
COPY MYFILE B:\DIR1\FILE
```

and you wanted the next command to be:

```
COPY MYFILE C:\DIR2\YOURFILE
```

The first character you want to change is B, so press **F2** and then type B. On your screen will appear everything up to but not including the B, ie.:

```
COPY MYFILE
```

In the stored command line, the cursor moves up to the letter B.

Type C. That gives you on the screen:

```
COPY MYFILE C
```

In the stored command line, the cursor moves past the B.

The next character you want to change is 1, so press **F2** and then type 1. Once again, everything from the current position of the cursor in the stored line up to but not including the character you typed is shown on the screen, giving you:

```
COPY MYFILE C:\DIR
```

Type 2, giving you:

```
COPY MYFILE C:\DIR2
```

Now you want just the next character from the old line, so press **F1**. Your new command line is now:

```
COPY MYFILE C:\DIR2\
```

Next you want to insert YOUR, without moving the cursor through the stored command line - so press **Ins**, type YOUR and then press **Ins** again. This gives you:

```
COPY MYFILE C:\DIR2\YOUR
```

The final stage is to add the remainder of the stored line (**FILE**) to the new line, which you do by pressing **F3**. Your new command line should now be:

```
COPY MYFILE C:\DIR2\YOURFILE
```

and you will have got this line with a total of 14 keystrokes instead of 28.

If you had forgotten to press **Ins** before typing **YOUR**, you would have effectively overwritten the **FILE** in the stored command and after pressing **F3**, you would still have:

```
COPY MYFILE C:\DIR2\YOUR
```

4.2.2 Stopping a program while it is running

From time to time, you may start a program running and then quickly realise that you don't want to run this program after all. You will be able to stop most programs from the keyboard by entering Ctrl-C or by holding down the **Ctrl** key and pressing the **Break** key.

- > **BREAK** > The length of time it takes before the program actually stops depends on the type of work the program is doing. If it is not taking input from the keyboard or sending output to the screen or to a printer, it may be a while before the program stops. If the time the program takes to stop is too long, you can use the **BREAK** command to add to the number of occasions MS-DOS looks at the keyboard to see if Ctrl-C or Ctrl-Break has been entered. This is particularly useful while you are developing a program that uses your disks very much more than the keyboard, the screen or the printer.

Some programs are designed to allow you to halt the program temporarily by pressing a particular key or combination of keys. A similar combination of keys may allow you to restart the program – for example, after you have noted down information that is being written on the screen. One such program is the **TYPE** command (see Section 5.2) which allows you to halt it by entering Ctrl-S and then to restart it by entering Ctrl-O. You will need to study the documentation provided with your program to find out if you can use keystrokes like these to halt and restart it.

4.2.3 Keeping a record of the work you do

If you have a printer attached to your PC, you can use this to record everything that appears on the screen – ie. everything you type in and everything your programs display on the screen for you. You could find recording all your actions a great help when it comes to analysing the work you have done or in preparing for future work using the same programs.

To start recording on the printer all the instructions you type in and all the messages MS-DOS displays, you enter Ctrl-P. A second Ctrl-P stops this information being output on the printer.

However, don't expect the print-out always to be identical to what you see on the screen. It will only be the same if the program writes to the screen line-by-line: spreadsheets, for example, don't.

- > **GRAPHICS** > Another way of recording what is displayed on the screen is to print an image of the screen. This is done simply by pressing a special combination of keys on the keyboard, but if there are pictures on the screen (rather than just text), you first need to prepare your PC by using the GRAPHICS command (or MDGRAPH if you have a monochrome display) for your printer.

Note: You will not be able to print most colour pictures from a CD or ECD screen.

Once this has been done and the printer is both switched on and on-line, you only need to hold down the **Ctrl** key and press **Prt Sc** each time you want to print the current screen display. Provided your PC has been properly set up for your printer, a picture of your screen will be printed in a few minutes.

DON'T PRESS THE **Prt Sc KEY IF THERE ISN'T A PRINTER ATTACHED TO YOUR PC**

4.2.4 Searching for files

A tidy approach to using your PC is to keep:

- MS-DOS external commands in one directory
- the program files and batch files of an application software package in another directory
- the data files associated with running the software package in a third directory

MS-DOS encourages this approach by searching a sequence of directories for files as if these directories were part of the default directory. This means that you can keep program and Batch files in directories other than the default directory but treat them in command lines as if they were in the default directory. (Batch files are described in Section 4.4.)

You will find this particularly helpful in using applications that make use of development software (eg. a programming language such as BASIC) as well as its own programs or when you need to use MS-DOS external commands alongside your applications programs. Continually moving the files containing MS-DOS software so that these are always in the same directory as the application software is not recommended or even always possible!

Separate methods are used to tell MS-DOS where to look for the files holding programs you want to execute and where to look for the files you want your program to process.

Extending the search for program files

Note: This applies to the program, command or Batch file you want to execute and to any program that is run as part of the Batch process. It doesn't apply to files that the program processes.

> **PATH** > If you type in a command line that doesn't specify where the command or program file is located, MS-DOS will always look for it in the current directory of the default drive. You can extend its search to a number of different directories by using the PATH command.

The PATH command gives MS-DOS a list of directories to try after it has failed to find the file in the default directory. MS-DOS will work systematically through these directories until it finds a COM, EXE or BAT file with the right filename or it comes to the end of the list – until, that is, you use the PATH command again (or you reset your PC, which loses all the details of the search path).

The PATH command is also used to display the directories that are searched at present.

Note: You must keep the list of directories to be searched up to date. If you delete a directory on the search path (see Section 5.1), you must redo your complete search path. Otherwise, the search will fail whenever MS-DOS tries to search the directory which no longer exists.

Searching for files to process

> **APPEND** > If you type in a command line that doesn't specify where the files you want to process are located, MS-DOS will always look for these in the current directory of the default drive. You can extend its search to a number of different directories by using the APPEND command. Most – but not all – programs can take advantage of this extra searching. (The full description of a program should tell you whether it can be used with the APPEND command to search extra directories.)

The APPEND command gives MS-DOS a list of directories to try after it has failed to find the file you have specified in the default directory. MS-DOS will work systematically through your list of directories until it finds the file (or it comes to the end of the list) – until, that is, you use the APPEND command again (or you reset your PC, which loses all the details of the search path).

The APPEND command is also used to display the directories that are searched at present.

Note: As with PATH, you should keep the list of directories up to date or the search will fail.

4.3 REDIRECTING INPUT AND OUTPUT

Programs are usually designed to take their standard input from the keyboard and to send their standard output to the screen. Under MS-DOS, however, a program can:

- take the input they require from another input device
- send the screen output to another output device
- take this input from a disk file
- store this output in a disk file

without any part of the program having to be re-written.

This section describes how to tell MS-DOS to take the standard input for the program you want to run from somewhere other than the keyboard and how to send the standard output it produces to somewhere other than the screen. It also describes how to 'pipe' the standard output from one program to another for further processing - in particular, how to pipe this output to one or more of the three MS-DOS filters FIND, SORT and MORE. These filters:

- find all the places a given string of characters is used
- sort data into alphanumeric order
- organise the output of data to the screen so that it is seen a screenful at a time

Note: The redirection described here applies only to the command line it is used in. If you want to redirect input and output more permanently, turn to Section 7.1.

4.3.1 Redirecting the standard input

You tell MS-DOS to take a program's console input from a different input device or a disk file by ending the usual command line with the details of the source of the input.

These details are written as follows:

<code><device-name</code>	if the input is to be taken from a different input device
<code><[d:][\][path\]filename.filetype</code>	if the input is to be taken from a file

A list of device names is given in Appendix IV.

For example, if the input for the program MYPROG is to be taken from the serial interface, you might have the command line:

```
A>MYPROG <AUX  
or A>MYPROG <COM1
```

If, however, it is to be taken from the file RUNDATA.1 on Drive C, you might have the command line:

```
A>MYPROG <C:RUNDATA.1
```

Take care, when you redirect input, that all the information the program needs is input through the different input device or stored in the file. The program will stop if it runs out of input data.

4.3.2 Redirecting the standard output

You tell MS-DOS to send a program's console output to a different output device or a disk file by ending the usual command line with the details of the destination of the output.

These details are written as follows:

> <i>device-name</i>	if the output is to be sent to a different input device
> [<i>d:</i>][<i>\</i>][<i>path\</i>] <i>filename.filetype</i>	if the output is to be sent to a file (replacing any existing file of that name)
>> [<i>d:</i>][<i>\</i>][<i>path\</i>] <i>filename.filetype</i>	if the output is to be appended to an existing file

A list of device names is given in Appendix IV.

For example, if the output from the program MYPROG is to be sent to the printer, you might have the command line:

```
A>MYPROG >PRN  
or A>MYPROG >LPT1
```

If, however, it is to be appended to the file RUNDATA.1 on Drive C, you might have the command line:

```
A>MYPROG >>C:RUNDATA.1
```

4.3.3 Piping output from one program to another

If you have a pair of programs with the standard output produced by one exactly the data required as standard input by the other, then you can use MS-DOS to pipe the information from the first program to the second. The second program of the pair is known as a filter.

You pipe information from one program to another by having both command lines on the same line as follows:

```
command-line-1 | command-line-2
```

For example, if you had a program called FILTER that processed the output from the DIR command, you might have the combined command line:

```
A>DIR C: | FILTER >STORE
```

where **DIR C:** is the first command line and **FILTER >STORE** the second.

If you have another filter program that can process the standard output from the second program, this output can be piped on to the next program and so on, simply by having the separate command-lines on the same line as follows:

```
command-line-1|command-line-2| ... |command-line-n
```

Typical tasks you might want a filter program for are:

- to find all the places a given string of characters is used
- to sort data into alphanumeric order
- to organise the output of data to the screen so that it is seen a screenful at a time

> **FIND** > These types of processing are provided by the three MS-DOS filters FIND, SORT and
> **MORE** > MORE: FIND does the job of searching through the output for text strings; SORT
> **SORT** > sorts the lines of output into alphanumeric order; and MORE arranges that the
output is displayed a screenful at a time.

These filters provide a good example of using one filter after another. You might well want to sort into alphanumeric order the output from, say, a DIR command and then ensure that the sorted directory is displayed a screenful at a time. You would do this with a command like:

```
DIR C:|SORT|MORE
```

Note: You cannot make use of piping within a Batch process.

4.4 SETTING UP A SEQUENCE OF COMMANDS

As you use your PC more, you are likely to find yourself typing in the same sets of commands – for example, each time you use a particular suite of commercial software or back-up your important files. This can be both tedious and error-prone.

- > **BATCH** > It would be better to put all the commands into a file and then just type one command which tells MS-DOS to execute this file. This is known as Batch Processing and the file containing the commands is called a Batch file. This section is about creating and running Batch files. It also describes a special Batch file that can be executed immediately after MS-DOS is loaded.

4.4.1 A simple Batch file

A Batch file is a file containing a sequence of MS-DOS command lines. It always has the filetype BAT.

The simplest form of Batch file – and by far the commonest – is just a list of MS-DOS command lines. So if, for example, running your suite of software means you type the three command lines:

```
CHDIR A:\WS
FUNCTION WS.PFK
WS
```

you create a file with these three lines as the lines of the file. (Use RPED for this – see Part I, Section 7.8.) **Note:** The usual rules apply to choosing a filename for this file; however, take care not to give it the same filename as any of your program or command files because MS-DOS will always execute a program or command file in preference to a Batch file.

If you called this file RUNWS.BAT, you would just use the filename RUNWS to run this particular suite of software. MS-DOS will execute the command lines one at a time, in the order they appear in the Batch file. In other words, typing:

```
RUNWS
```

is exactly equivalent to typing:

```
CHDIR A:\WS
FUNCTION WS.PFK
WS
```

Notice that you type **RUNWS** and not **RUNWS.BAT**.

The command lines will be displayed on the screen one by one as your PC executes them.

Note: If a command line you want to include in a Batch file contains the character %, (other than in a dummy parameter – see Section 4.4.3) type this as %%.

4.4.2 Making a Batch file more versatile

You may want your Batch file to handle

- repeated commands or commands that you only want executed under certain circumstances.
- a more appropriate way of logging your PC's progress on the screen.
- pausing in the middle of batch process to change disks, for example.
- carrying out similar actions but with different sets of program files and data files.

These facilities are provided by some special Batch Subcommands and Batch file parameters. How to use these is described below, with full details of the Subcommands given at the end of the chapter.

Repeated or conditional commands within Batch files

- > **FOR** > In a typical Batch file, you may have:
 - > **GOTO** > – the same program file used in a number of command lines, one after the other
 - > **IF** > – the same data file(s) used in a number of command lines, one after the other
 - command lines that you only want executed if certain conditions are met
 - short sequences of command lines that are used over and over again in a loop
- Batch processing has the subcommands FOR, GOTO and IF (and IF NOT) to handle repeated or conditional actions.

FOR	is used where essentially the same command line is used repeatedly
GOTO	is used to direct MS-DOS to a different command (marked by a label)
IF	is used to make MS-DOS take different actions, depending on the truth of some statement

You can make a whole series of actions depend on a single test by using IF and GOTO together.

Logging your PC's progress on the screen

- > **ECHO** > Normally while a Batch file is running, each MS-DOS command line is displayed on the screen just before it is executed. This is the default way of showing its progress
- > **REM** > but there are other possibilities:
 - displaying command lines and additional messages
 - displaying just some special messages
 - no on-screen messages

Which option you choose depends what the individual commands in the Batch file do. For example, you might opt for either no on-screen messages or just some special messages if the commands gradually build up output on the screen. If the commands split up into a number of stages, you might want to use additional messages to show which stage your PC has reached.

The Batch subcommands, ECHO and REM, let you determine what appears on the screen:

ECHO controls whether the MS-DOS command lines are displayed (it doesn't affect the output from your programs in any way) and gives you one way of displaying special messages

REM also lets you display special messages

If you want both command lines and special messages displayed, use REM for the additional messages. If you don't want the command lines displayed, use ECHO both to turn off the display of command lines and to generate the special messages. This is because turning off the command line display also stops any REM messages from being displayed. (Note: It also stops the special messages associated with PAUSE commands from being displayed – see 'Pausing in the middle of a Batch process' below.)

Another use for REM commands in a Batch file is simply to space out the other commands and so make the file more readable.

Pausing in the middle of a Batch process

> **PAUSE** > If you need to swap disks, for example, in the middle of processing a Batch of commands, you should put a PAUSE subcommand in your Batch file. This subcommand is put between the last command line you want executed before you swap the disks and the first one to use the new disks.

When you run the Batch file, your PC will stop after the PAUSE subcommand. You can then change disks or whatever. When you are ready for your PC to continue, press one of the character keys on the keyboard (say, for example, the space bar). The next command in the Batch file will then be executed.

The PAUSE subcommand can include a message which will be put up on the screen just before the program halts. You can use this message to remind you what to do before MS-DOS resumes running the Batch file.

If you remove the disk with the Batch file from its drive so that one command line can be executed, you will have to re-insert it before the following command line in the file can be executed. A message will appear on the screen instructing you to put the disk back in the drive. Another PAUSE command will be needed if you want to swap the disks again.

4.4.3 Using Batch files for more than one job

You can use one Batch file to carry out the same operations but on different files by using dummy parameters in the file. Such a Batch file is called a 'Multi-purpose Batch file'.

The standard set of parameters are the characters %0...%9. Each of these parameters stands in for a 'value' which you supply when you run the Batch file. For example, suppose you wanted a Batch file that could be used to copy any file in any directory on the default drive to any other directory, you could use one parameter to represent the file and one to represent the source directory and another to represent the destination directory.

Batch files can also make use of 'environment strings' as parameters. These environment strings and the names used to represent them are made available to each program as it is run. They are mainly set up by using a SET command (see Section 4.1). To make use of an environment string in a Batch file, you simply include its name surrounded by percent characters as a parameter. For example, if you wanted the way your Batch process proceeded to depend on whether your environment parameter DISPLAY was CGA or EGA, you would include the parameter %DISPLAY% in an IF subcommand in the Batch file like this:

```
IF "%DISPLAY%"=="CGA" GOTO LABEL
```

Parameters can represent any string of characters in a Batch file command line (other than spaces and Batch subcommands themselves). They can therefore be used to represent:

- a filename
- a directory
- a path
- a command line parameter
- a string of characters to compare in an IF command
- a label
- a part of any of these
- any combination of these

For example, in your Batch file MYBAT.BAT, you might represent the filename of a file you want to copy by %1 and the filename of the copy by %2. You might therefore have a line in the file like this:

```
COPY %1.TXT B:%2.NEW
```

When you run the Batch process, you follow the name of the Batch file by the values you want the parameters to represent. MS-DOS then assigns values to the parameters in order, starting with %0 which is assigned the drive, directory and filename of the Batch file. %1 takes the first value in your list, %2 the second, and so on. So running the Batch file MYBAT.BAT with the command:

```
A:MYBAT File1 File2
```

would replace each %0 in MYBAT with A:MYBAT, each %1 with File1 and each %2 with File2. So MS-DOS would actually obey the command:

```
COPY File1.TXT B:File2.NEW
```

- > **SHIFT** > The ten dummy parameters you get from %0...%9 is usually plenty, but it is possible to use more if you use the SHIFT subcommand. SHIFT can also be used to apply the same group of actions to an unspecified number of files, one after another. How to do this is described alongside the details of the SHIFT subcommand at the end of this chapter.

4.4.4 Interrupting a Batch process

You interrupt a Batch file while it is running by entering either Ctrl-Break or Ctrl-C at the keyboard.

The command currently being executed is immediately abandoned but not the rest of the batch of commands. Instead, MS-DOS asks you whether you want to abandon these. If you type **N** for No, the remainder of the Batch file is processed normally.

4.4.5 Obeying a Batch file automatically

> **AUTOEXEC.BAT** > MS-DOS will obey a Batch file automatically when you turn your PC on or reset it, if this file is called AUTOEXEC.BAT and it is stored in the root directory of your Startup disk (ie. the disk you use to load MS-DOS from).

Immediately after the operating system software has been loaded into your PC's memory, MS-DOS looks to see if there is a file called AUTOEXEC.BAT in the default drive. If it finds one, the commands it contains are executed before you can use your PC for anything else (though you can always interrupt it by entering Ctrl-Break or Ctrl-C).

AUTOEXEC.BAT cannot be a multi-purpose Batch file.

The AMSTRAD PC is supplied with an AUTOEXEC.BAT file on Disk 1 that:

- sets up your keyboard as a UK keyboard (see Appendix V)
- loads the mouse driver (MOUSE.COM) so that you can use the mouse with the programs you run (see Appendix I)
- detects what kind of display you have by reading the 'display selector' switches (see Appendix I)

If this is not what you want, either erase this file and create a new AUTOEXEC.BAT file or edit the current AUTOEXEC.BAT file so that it contains the commands you need. (Use RPED to edit the file - see Part I, Section 7.8.) These commands will then be the ones executed the next time you load the operating system.

Special sets of Batch files on Disk 1 and Disk 2 allow you to load GEM after you have loaded the operating system, ie. as a separate operation. These Batch files operate closely with the built-in disk (Drive C) and ensure that, where possible, COMMAND.COM is available.

In the case of a Hard Disk PC the AUTOEXEC and GEM Batch files you will normally use are copies from the \SUPLEME folder on Disk 4. They differ in certain details from the files of the same name on Disks 1 and 2.

APPEND

External command

APPEND [d:]\path[; [d:]\path...]

Set a search path for data files

Normally, if you don't say which directory a file is in, MS-DOS tries to find it in the default directory. The APPEND command sets up a sequence of directories that MS-DOS will search for data files alongside the default directory. In effect what happens is that each path given in the APPEND command is used in turn with the data file until the file is found. Each path specifies a separate directory. The default directory is always searched first.

This gives you a neat way of ensuring that the data files you need are accessible without clogging up your current directory.

Form APPEND [d:]\path[; [d:]\path...]

Notes Each path must start from a root directory.

The directories are searched one by one in the order given in the APPEND command until a file matching the file specification is found or the sequence of directories is exhausted.

Not all programs can take advantage of the search path set up by an APPEND command.

Example

The program you plan to use helps you to prepare letters using information from accounts files you have stored on disk in three separate directories: \CLIENTS1, \CLIENTS2 and \CLIENTS3.

To get MS-DOS to search all three directories, use the command line:

APPEND \CLIENTS1;\CLIENTS2;\CLIENTS3

assuming that the external command APPEND is in one of the directories MS-DOS automatically searches for program files (see Section 4.2.4) and that the three client directories are all on your default drive. If the directories were on Drive B, your command line would be

APPEND B:\CLIENTS1;B:\CLIENTS2;B:\CLIENTS3

ASSIGN

External command

ASSIGN *requested-drive*=*searched-drive*

Assigns drive letter to another drive

The ASSIGN command tells MS-DOS to convert instructions to read or write files on one drive into instructions to read or write files on another drive. This lets you use drives other than those your program was set up to use.

The ASSIGN command used on its own without a command tail cancels all the current 'assignments'.

- To set up one or more assignments

Form ASSIGN *d=d* [*d=d...*]
 | |
 | | Searched drive
 | | Requested drive

- To clear one assignment

Form ASSIGN *d=d*
 | |
 | | Requested drive
 | | Requested drive

- To clear all current assignments

Form ASSIGN

Note You don't have to type the colon after the drive letter when you specify either the searched drive or the requested drive.

Examples

- You want all requests for Drive B to be directed to Drive C. The command line you need is:

ASSIGN B=C

(assuming that the external command ASSIGN is stored either in the default directory or in a directory that MS-DOS automatically searches - see Section 4.2.4)

- You have assigned both Drive A and Drive B to Drive C, but now you want to have requests for Drive A going to Drive A. The command line you need is:

ASSIGN A=A

BREAK

Internal command

BREAK ON|OFF

Sets how often MS-DOS checks for Ctrl-Break

The way to stop the program you are running is to press either Ctrl-C or Ctrl-Break on the keyboard. MS-DOS normally checks whether Ctrl-C or Ctrl-Break has been pressed when it is taking input from the keyboard or sending output to the screen or to a printer.

The BREAK command lets you extend the number of occasions on which MS-DOS checks for Ctrl-C or Ctrl-Break to other functions, for example reading data from a disk or writing data to a disk. However, this slows down each program's speed of operation slightly and so whenever this extra checking isn't needed, it should be turned off again.

- To increase the number of occasions

Form BREAK ON

- To return to standard checking

Form BREAK OFF

Example

You want to stop the next program if it goes wrong, yet you know that for much of the time it will be taking input from disk and sending all its output to disk. The command line you need is:

BREAK ON

When you are happy with the program and would prefer it to run a little bit faster again, type the command line:

BREAK OFF

CHDIR

Internal command

CHDIR [d:][\]path

Change the current directory

CHDIR is used to:

- change the current directory of a particular drive
- display the current directory path of a particular drive

If the path you give starts from the root directory, you will need the optional backslash. If it starts from the current directory, don't include this backslash.

CHDIR can be abbreviated to CD.

- To change the current directory

Form CHDIR [d:][\]path
or CD [d:][\]path

- To display the current directory path

Form CHDIR [d:]
or CD [d:]

Examples

Suppose this was the pattern of directories on the disk in Drive B:

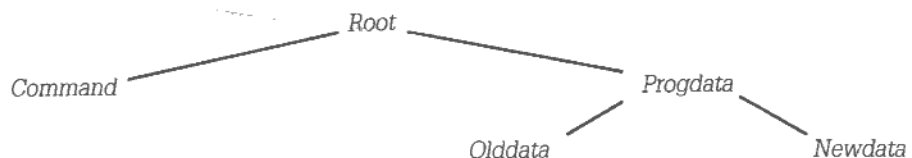

- You want the Progdata directory – a subdirectory of the Root directory on Drive B – to be the current directory on Drive B. The command line you need is:

CD B:\PROGDATA

Note the use of the backslash to tell MS-DOS that Progdata is a subdirectory of the Root directory on this disk.

- After using Progdata as the current directory for a while, you next want to move on to using Newdata. The command line to use is:

CD B:NEWDATA

Note that there is no backslash between the colon and the name of the directory in this command line, because Newdata is a subdirectory of the current directory.

- To reset the current directory on the default drive to the Root directory, type the command line:

**CD **

-
- You want to find out which directory on Drive C is the current directory. The command line to type is:

CD C:

and the response might be:

C:\DIR1

CLS

CLS

Clear the screen

Internal command

CLS clears the screen and leaves the cursor in the top lefthand corner of the screen.

Form CLS

Note If the screen has been working in reverse video ('black' characters on a white background), it will go back to its normal mode of operation ('white' characters on a 'black' background) after the screen is cleared.

Example

```
A>dir
Volume in drive A has no label
Directory of A:\

COMMAND  COM      25612  21/05/86  12:31a
DISKCOPY EXE      3836  21/05/86  12:31a
DOODLE   APP      12512  22/05/86  11:51a
DOODLE   RSC       4046  22/05/86  11:51a
GENSYS   <DIR>    27/05/86  14:31a
GEMDESK  <DIR>    28/05/86  15:12a
BASIC2   <DIR>    28/06/86  12:00a
GEMAPPS  <DIR>    30/06/86  14:56a

      4 File(s)      140640 bytes free

A>cls
```

Press 

```
A>
```

DIR

Internal command

DIR [d:][\][path\][filename.filetype][P][W]

Display directory

The DIR command is used to:

- **display details of the files in a directory**
- **display details of a particular file, a group of files or all the files in the directory**
- **test whether a particular file or group of files is present in a particular directory**
- **list all the files in a directory that match a given wildcard file specification**

Alongside this information, you will also see:

- the disk label of the disk holding the files (if any)
- the amount of free space on the disk

Files are listed in the order they appear in the directory.

The information can be displayed in a number of different forms. Which style of display is used depends on which of the optional parameters /P and /W are selected. The version with no parameters gives a list of each file's filename and filetype together with its size in bytes and the time and date it was last changed. If this list is more than one screenful, the display will continuously scroll up until all the directory has been displayed.

- **To display details of all the files and directories in a directory**

Form DIR [d:][\][path\][P][W]

- **To display details of a single file or a group of files**

Form DIR [d:][\][path\]filename.filetype[P][W]

*File specification of particular file
or wildcard file specification of a group of files*

- **To display details of all the files with the same filename**

Form DIR [d:][\][path\]filename[P][W]

Note: Any directories with this name will also be displayed.

- **To display details of all files with the same filetype**

Form DIR [d:][\][path\].filetype[P][W]

- Options** /P The display pauses after every screenful of information. Press a character key to see the next screenful.
- /W Just the filenames and filetypes, with five files catalogued on each line.

Examples

- To display full details – ie. filename, filetype, size and date when last changed – all the files in the default directory (ie. the current directory on the default drive), type the command line:

DIR

To display just the names of these files, five to a line, use the command line:

DIR/W

- To display, five to a line, the names of all the files in the current directory on Drive C, use the command line:

DIR C:/W

- To display full details – ie. filename, filetype, size and date when last changed – of the files in the Root directory on Drive C, use the command line:

DIR C:\P

the /P ensuring that the output will pause at the end of each screenful of information. Press any character key (for example, the Space bar) to see the next screenful.

- To display full details of just those files on the default drive that have a filename starting with the letter D and the filetype MY, use the command line:

DIR D*.MY

Note the use of the wildcard character * to create a file name template against which to match the names of all the files in the directory. * represents any valid combination of characters including, in this instance, blank.

- To search the \DIR1 directory for files with the filetype MY, use the command line:

DIR \DIR1*.MY

DIR interprets this command line as if it had the wildcard character * in front of the dot, allowing the template to match any valid filename.

- To search the \DIR1 directory for files and directories with names starting MY, use the command line:

DIR \DIR1\MY*

DIR interprets this command line as if it had .* at the end of the command line, allowing the template to match any valid filetype.

FIND

External command
and External filter

FIND [/V][/C][/N] "string" [d:][\][path\]filename.filetype

Look for a string of characters in a file

FIND is used to search for a given string of characters in one or more files. These can be either files that are stored on disk or the output file from the previous program which is piped to the FIND filter or data that you type in at the keyboard (everything you type after issuing the FIND command until you enter Ctrl-Z).

The string of characters must be surrounded by quotation marks. If the string itself has quotation marks round it, then both sets of quotation marks must be typed.

The string of characters must be entered exactly as it is in the file if the string is to be found. In particular, it must contain the same upper and lower case characters.

The result of the search is displayed on the screen. This can be:

- the lines in which the string of characters was found
- the number of such lines
- the lines in which the string was not found depending on which of the /V, /C and /N options were selected.

If no option is selected, the lines in which the string of characters was found are displayed.

- To find a given string of characters in one or more disk files

Form FIND [/V][/C][/N] "string" [d:][\][path\]filename.filetype [d:][\][path\]filename.filetype...]

- To find a given string of characters in what you type at the keyboard

Form FIND [/V][/C][/N] "string"

- To find a given string of characters in the output of another program

Form command | FIND [/V][/C][/N] "string"

Options /V Display all lines except those containing the specified string
/C Display the number of lines in which the string was found
/N Number the lines according to their position in the file

Examples

- You want to display all the lines in MYFILE.TXT that contain the word **computer**. If you are interested in including all the variants (eg. microcomputer, computers, etc.), use the command line:

FIND "computer" MYFILE.TXT

(assuming that the external command FIND is stored either in the default directory or in a directory that MS-DOS automatically searches - see Section 4.2.4)

If you want just the word **computer**, you might use the command line:

```
FIND " computer " MYFILE.TXT
```

though this wouldn't pick out **computer.**, **computer**, etc.

- You want to display and number all the lines in **MYFILE.TXT** that contain the phrase **"Best Fit"**, complete with quote marks. The command line to use is:

```
FIND/N ""Best Fit"" MYFILE.TXT
```

Note the use of two sets of quote marks.

- You want display full details of all the files in the current directory that were last changed on a particular date, for example 26th September 1986. To do this, you want to use the instruction **DIR** to list the directory but to filter this list before it is displayed on the screen by using the **FIND** command to filter out just those lines containing the date 26-09-86. The **FIND** instruction you want is **FIND "26-09-86"**, giving you a complete command line of:

```
DIR|FIND "26-09-86"
```

GRAPHICS

External command

GRAPHICS *printer-type*[/R][/B][/F][/C]

Prepare your PC to print graphics screen displays

The GRAPHICS command prepares your PC Colour Display (CD) or PC Enhanced Colour Display (ECD) so that what is displayed on the screen is correctly reproduced on the printer attached to your PC. This can either be a colour printer or a monochrome printer. Colour screen information sent to a monochrome printer may be printed in up to sixteen shades of grey.

Note:

- 1 To print a graphics screen from the PC Colour Display or Enhanced Colour Display it is necessary to be using software compatible with the IBM colour graphics adaptor. Such software displays in black and white only. Further explanation of the various requirements for operating IBM colour graphics adaptor software is given in Appendix I.**
- 2 This command must not be used when operating a monochrome display PC. Use MDGRAPH instead.**

Through this command, you can chose whether the screen display is printed as 'light' text on a 'dark' background or as 'dark' text on a 'light' background and, if you have a colour printer, whether the background is all coloured in the background colour. These features are selected through the /R and /B options.

Form GRAPHICS [*printer-type*[/R][/B][/F][/C]

Printer types	COLOR1	IBM Personal Computer Color Printer (or compatible) with a black ribbon
	COLOR4	IBM Personal Computer Color Printer (or compatible) with an RGB (red, green, blue and black) ribbon
	COLOR8	IBM Personal Computer Color Printer (or compatible) with a CMY (cyan, magenta, yellow and black) ribbon
	COMPACT	IBM Personal Computer Compact Printer (or compatible)
	GRAPHICS (or nothing)	IBM Personal Computer Graphics Printer (or compatible, for example the AMSTRAD DMP3000)
	COLORJET	IBM Color Jet Printer (or compatible)
Options	/R	Print foreground light, background dark as seen on the monitor. If this option isn't selected, then the foreground is printed dark and the background light.
	/B (printer-types COLOR4 and COLOR8 only)	Print the background colour. If this option isn't selected, the background colour isn't printed.
	/F	Turn the screen dump round through 90°.
	/C	Centre the screen dump on the page.

Notes Using the GRAPHICS command reduces the amount of RAM available for processing other commands and for running programs. This memory space is not made

available again until your PC has been switched off or reset.

320 x 200 pixel screens are printed with the top of the screen towards the top of the sheet of paper unless the /F option has been selected. 640 x 200 pixel screens are printed with the top of the screen along the lefthand edge of the paper (not affected by the /F option).

Examples

- To set up your PC to work with the Amstrad DMP3000 printer (or some other printer that is compatible with the IBM Personal Computer Graphics Printer), use the command line:

GRAPHICS

(assuming that the external command GRAPHICS is stored either in the default directory or in a directory that MS-DOS automatically searches – see Section 4.2.4)

Once this instruction has been used, you can then print out a picture of your screen at any time by holding down the  key and pressing **Prt Sc** until you reset your PC.

Note: The foreground will be printed in black and the background will be white.

- To set up your PC to work with an IBM Personal Computer Color Printer (or compatible printer) with a black ribbon so that it prints the foreground in white against a black background, use the command line:

GRAPHICS COLOR1/R

JOIN

External command

JOIN *d:* [*d:*][\]*path*

Join a disk drive into another disk's directory structure

JOIN adds the directory structure on one drive onto the directory structure on a second drive. It does this by telling MS-DOS to interpret any path to a directory on the second drive as an instruction to look on the first drive.

The directory the drive is joined to must be empty and it must be in the root directory of the second drive. If the directory you specify in the JOIN statement doesn't already exist, the JOIN command will create it for you.

If you use command on its own without a command tail, JOIN displays a list of all the joins that are currently in force.

- To join a drive to a directory

Form JOIN *d:* [*d:*][\]*path*

*The directory the drive is joined to
The drive joined to the directory*

- To break the join

Form JOIN *d:*/D

The drive that had been joined

- To display current joins

Form JOIN

Notes After you have joined a drive to a directory, don't try to use the joined drive in the normal way. MS-DOS now regards this drive as an 'Invalid drive'.

If the directory isn't empty when you try to make the join, the message **Directory not empty** will be displayed.

You cannot break the join between a drive and a directory if the file holding the external command JOIN is in the drive.

Examples

Suppose the directory structure on the disk in Drive A is like this:

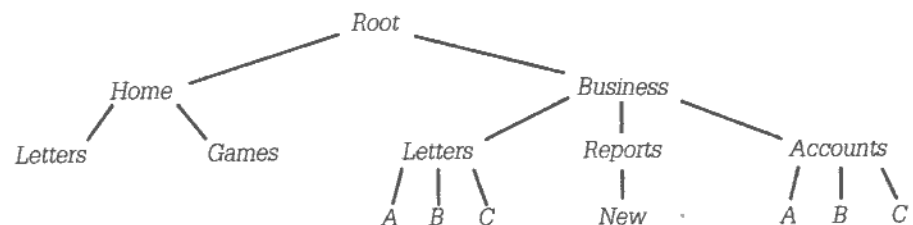

- To put the disk in Drive C into this directory structure, you would type a command line of the form:

JOIN C: A:\path

(assuming that the external command JOIN is stored either in the default directory or in a directory that MS-DOS automatically searches – see Section 4.2.4)

- To make a specially created directory called DriveC represent the drive, use the command line:

JOIN C: A:\DRIVEC

This will automatically create the new directory for you and position it in the Root directory, giving you the directory structure:

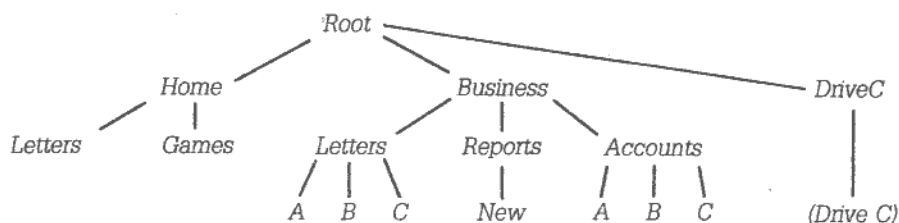

- You might want to make Drive C part of the Home directory and so type the command line:

JOIN C: A:\HOME

This will be rejected because the directory must be empty. The Home directory has at least two subdirectories in it (ie. Letters and Games)

- Knowing that the directory called New was empty, you might type the command line:

JOIN C: A:\BUSINESS\REPORTS\NEW

This would be rejected by MS-DOS. The drive can only be joined to a subdirectory of the Root directory.

- To break the connection between Drive C and the directory DriveC, use the command line:

JOIN C:/D

MDGRAPH

External command

MDGRAPH

Prepare your PC to print graphics screen displays

The MDGRAPH command prepares your PC MD so that the screen display is correctly reproduced on the printer attached to your PC.



Note

- 1 To print a graphics screen from the PC MD it is necessary to operate software compatible with the Hercules graphics adapter. Further explanation of the various requirements for operating monochrome graphics software is given in Appendix IV.
- 2 This command must not be used when operating the PC CD or PC ECD. Use GRAPHICS instead.

The command may be used to dump either of two pages of screen memory. There is no sure guide to whether you need to print page 0 or page 1. You will need to experiment. A bold vertical bar will appear on the lefthand side of the screen if you have chosen correctly. This bar will move across the screen as the printing proceeds. If you do not see this bar, then abandon the printing and repeat with the alternative selection.

Form MDGRAPH

-  **PrtSc** causes the PC to halt and beep. One or more of the following options must then be selected by typing at the keyboard.

- Options
- R Reverses the background and foreground shading. Must be the first option selected.
 - 0 Prints page 0. This page is used, for example, by GEM software.
 - 1 Prints page 1. This page is used, for example, by Lotus 1-2-3 version 1A.
 -  For specialist use only. Perform text screen print, or colour screen print if the GRAPHICS command was used before the MDGRAPH command.
 -  Abandon screen print. This option may be used at any time.

- Note** Using the MDGRAPH command reduces the amount of RAM available for processing other commands and for running programs. This memory space is not made available again until your PC has been switched off or reset. The visible vertical bar indicates how much of the screen printing has been transmitted to the printer, which may have a buffer and therefore appear to lag behind.

Examples

- To set up your PC to work with the AMSTRAD DMP3000 printer (or some other printer that is compatible with the IBM Personal Computer Graphics Printer), use the command line:

MDGRAPH

(assuming that the external command MDGRAPH is stored either in the default directory or in a directory that MS-DOS automatically searches - see Section 4.2.4).

Once this instruction has been used, you can print out a picture of your screen at any time (until you reset your PC) by holding down the **[⇧]** key and pressing **[PrtSc]**. Your PC will beep. Then press **0** or **1**. There is no sure guide to whether you need to press **0** or **1**. You will need to experiment. A bold vertical bar will appear on the lefthand side of the screen if you have chosen correctly. This bar will move across the screen as the printing proceeds. If you do not see this bar, then abandon the printing by pressing **[Esc]** and repeat with the alternative selection.

Note The foreground will be printed in black and the background will be white.

- To print the foreground in white against a black background, hold down the **[⇧]** key and press **[PrtSc]**. Your PC will beep. Then press **R** followed by **0** or **1**.
-

MORE

External filter

MORE

Display output one screenful at a time

The MORE filter is used to control the display of the program output on the screen so that this is only displayed one screenful at a time. The next screenful will only be displayed after you have pressed the key, and so on until all the output has been displayed.

Form command | MORE

Example

Your program *ANALYSIS.EXE* displays its results on the screen. To see the results of processing the data stored in *MYDATA.RAW* a page at a time, use the command line:

ANALYSIS MYDATA.RAW|MORE

(assuming that the external filter *MORE* is stored either in the default directory or in a directory that *MS-DOS* automatically searches – see Section 4.2.4)

Press to see the next page of output.

PATH

Internal command

PATH [d:\path[;[d:\path...]

Define a search path

Normally, if you don't say which directory a program file is in, MS-DOS tries to find it in the default directory. PATH sets up a sequence of directories the MS-DOS will search for program files alongside the default directory. In effect what happens is that each path given in the PATH command is applied to the program filename in turn until the file is found. Each path specifies a separate directory. The default directory is always searched first.

This gives you a neat way of, for example, ensuring external commands are accessible without clogging up your current directory.

- **To set up a new path**

Form PATH [d:\path[;[d:\path...]

- **To clear the existing path**

Form PATH ;

Notes Each path must start from a root directory.

The directories are searched one by one in the order given in the PATH command until a file matching the file specification is found or the sequence of directories is exhausted.

You must keep the search path up to date. If MS-DOS tries to search a directory that no longer exists, your command will fail.

Examples

- You have stored all the MS-DOS external commands in a directory called \COMMANDS on Drive C. To get MS-DOS to search for the external commands as if they were always in the default directory, use the command line:

PATH C:\COMMANDS

- The current search path is:

A:\GEMAPPS;A:\GEMSYS

and you want to extend this list to include C:\COMMANDS. The command line to use is:

PATH A:\GEMAPPS;A:\GEMSYS;C:\COMMANDS

- You delete the \COMMANDS directory which you know is on the current search path. To bring the path up to date, first discover the current search path by typing the command line:

PATH

If the response is:

A:\GEMAPPS;A:\GEMSYS;C:\COMMANDS

the command line you need to type is:

PATH A:\GEMAPPS;A:\GEMSYS

- *To clear the path, thus making the default directory the only directory to be searched, use the command line:*

PATH ;

SET

Internal command

SET *parameter=string*

Set an environment string

The SET command is used to set an environment string, that is one of the special strings of characters that are available to each program you run. The program will respond to this string if it is designed to use the parameter to which it has been set. Environment strings can also be used by Batch processes (see Section 4.4).

MS-DOS records the parameter and the string you have set it to in the area of memory reserved for environment strings. If the parameter is already recorded, the new string replaces the one currently recorded. If you set the parameter equal to blank, the parameter is removed from the list of environment strings.

If you use the SET command on its own without a command tail, MS-DOS lists all the environment strings that have been set - both through SET commands and automatically, for example through the use of other commands.

- **To set or reset a parameter**

Form SET *parameter=string*

- **To remove a parameter from the environment**

Form SET *parameter* =

- **To list the current environment strings**

Form SET

Notes Details of which environment parameters a program needs to have set and what these should be set to should be given in the program's own user guide.

The list of current environment parameters and strings will contain a number that you won't know have been set. These are likely to be used by MS-DOS and shouldn't be removed from the list unless you are fully aware of the role they play.

Example

- Suppose a program behaves differently depending on whether the environment string represented by the parameter DISPLAY is CGA or EGA. To set DISPLAY to CGA, type the command line:

```
SET DISPLAY=CGA
```

Later, you can set it to EGA by typing:

```
SET DISPLAY=EGA
```

- To list on the screen the present set of environment parameters and strings, type the command line:

SET

A list similar to the following will appear on the screen:

```
A>set  
PATH=  
COMSPEC=A: \COMMAND . COM  
DISPLAY=CDMOND
```

Note the inclusion of parameters that you haven't used a SET command to set. These have been set by other MS-DOS commands or by the operating system itself.

SORT

External command
and External filter

`SORT [/R][/+n] <[d:][\][path\]filename filetype [>destination]`

Sort data

SORT is used to sort data into alphanumeric order. It can:

- sort data stored in an existing file
- sort standard output from a different program
- sort into reverse order as well as into the normal order
- sort lines into alphabetical order based on the character at a given column in each line, not necessarily Column 1

The style of the sort depends on which of the /R and /+n options are used. If no option is selected, the data is sorted into normal alphabetical order based on the character in Column 1 of each line.

The result of the sort can be sent to a file or to a specified output device. If no destination is specified, the sorted data is sent to the screen.

- To sort data in a file

Form `SORT [/R][/+n] <[d:][\][path\]filename filetype [>destination]`

- To sort data generated by a program

Form `command | SORT [/R][/+n] [>destination]`

Options /R Reverse the sort, ie. sort from Z to A
/+n Sort at Column n

Examples

- To sort the Root directory on Drive C before it is displayed, use the command line:

`DIR C: | SORT`

(assuming that the external command SORT is stored either in the default directory or in a directory that MS-DOS automatically searches – see Section 4.2.4)

- To sort the lines in a text file called ROUGH.TXT into alphabetical order and store the result in a file called SORTED.TXT, use the command line:

`SORT <ROUGH.TXT >SORTED.TXT`

- To sort the lines in the file ROUGH.TXT in such a way that the characters eight character positions in on each line are in alphabetical order and to display the result on the screen, use the command line:

`SORT /+8 <ROUGH.TXT`

VER

Internal command

VER

Display MS-DOS version number

VER displays the version number of the MS-DOS operating system you are using.

Form VER

Example

To see which version of MS-DOS you are currently using, type:

VER

A message similar to the following will appear on the screen:

MS-DOS Version 3.20

VERIFY

Internal command

VERIFY ON|OFF

Turn on and turn off verification of all writes to disk

The VERIFY command is used to tell MS-DOS to verify that each file written to a disk can be read back successfully by checking, for example, that it doesn't contain any bad sectors. It is also used to turn off the verification procedure.

If the VERIFY command is used on its own, without any parameters, your PC will display whether verification is currently turned on or off.

- **To turn verification on**

Form VERIFY ON

- **To turn verification off**

Form VERIFY OFF

- **To show current state**

Form VERIFY

Notes While verification is turned on, you will only get a message on the screen when a disk error has been spotted.

Do not assume that verification is turned on because you haven't entered a VERIFY OFF command. Verification can be turned off from within a program.

BATCH

Internal commands

`[d:][\][path\]filename [value[value...]]`

Run a batch of commands

BATCH processing executes a sequence of commands stored in a specified Batch file. The commands are executed in the order they appear in the Batch file.

The commands in the Batch file can be:

- either standard MS-DOS commands
- or special BATCH subcommands.

These commands can make use of the dummy parameters %0...%9 standing in for values which are supplied when the Batch file is run.

If the Batch file is called AUTOEXEC.BAT and stored in the root directory of the Startup disk, the sequence of commands it contains will be executed immediately after the operating system has been loaded.

Form `[d:][\][path\]filename [value-1 [value-2...]]`

where *filename* is the filename of the Batch file and replaces parameter %0 and *value-1* is to replace the parameter %1, *value-2* is to replace the parameter %2, and so on.

Notes The Batch file must have the filetype BAT. The BAT filetype is not included in the command line.

The Batch file can contain the names used to represent environment strings as parameters (see Section 4.1). These parameters are included in the file as %*name*% and they will be replaced when the Batch file is run by the string currently associated with the name.

The execution of a Batch file can be interrupted by pressing either Ctrl-Break or Ctrl-C. A message then appears on the screen asking if you want to abandon the remaining commands.

- If you type Y, the remainder of the Batch file is ignored and the system prompt appears on the screen.
- If you type N, only the current command is abandoned.

If you remove the disk holding the Batch file from its drive for the execution of one of the command lines, MS-DOS will prompt you to replace this disk before the next command line is executed.

You can run a Batch process from within another Batch process. Normally, you would use the last line of the Batch file to start this second Batch process because no return can be made to the original Batch process.

Special BATCH subcommands

ECHO	Turns on or off screen display of MS-DOS commands as they are executed
FOR	Repeats the same or similar command line a number of times
GOTO	Directs MS-DOS to a special point in the file, marked by a label
IF	Executes a command only if a statement is true
IF NOT	Executes a command only if a statement is false
PAUSE	Stops further execution of a Batch file until a key on the keyboard is pressed
REM	Displays a special message on the screen
SHIFT	Assigns new values to Batch file parameters

These subcommands are described in detail in the following pages.

The Batch subcommands FOR and IF can also be used outside Batch files.

Examples

- A Batch file called *RUNLOTUS.BAT* that:
 - directs printer output to the Serial Interface on the back of your PC
 - makes a directory called *\123FILES* the current directory on the default drive
 - runs Lotus 1-2-3would contain the lines:

```
MODE LPT1:=COM1:  
CD \123FILES  
LOTUS
```

Set up this simple Batch file either by using the AMSTRAD PC text editor *RPED* or with a *COPY* command (see Section 5.2.1).

- In your Batch file *MYBAT.BAT*, you might represent the filename of a file you want to copy by %1 and the filename of the copy by %2. You might therefore have a line in the file like this:

```
COPY %1.TXT B:%2.NEW
```

When you run the Batch process, you follow the name of the Batch file by the values you want the parameters to represent. MS-DOS then assigns values to the parameters in order, starting with %0 which is assigned the drive, directory and filename of the Batch file. %1 takes the first value in your list, %2 the second, and so on. So running the Batch file *MYBAT.BAT* with the command:

```
A:MYBAT File1 File2
```

would replace each %0 in *MYBAT* with *A:MYBAT*, each %1 with *File1* and each %2 with *File2*. So MS-DOS would actually obey the command:

```
COPY File1.TXT B:File2.NEW
```

ECHO

Batch subcommand

ECHO [ON|OFF|*remark*]

Control echoing of commands on the screen

Normally, as a Batch file is being obeyed, each command line that MS-DOS executes is displayed on the screen just before it is executed.

The ECHO subcommand lets you:

- turn the display of command lines off
- turn the display of command lines on
- display a message, regardless of whether command lines are being displayed

- **Turn the display off:**

Form ECHO OFF

- **Turn the display back on**

Form ECHO ON

- **Display a message**

Form ECHO [ON|OFF] *remark*

Notes ECHO OFF stops REM messages and PAUSE special messages from being displayed on the screen. The PAUSE subcommand message **Press any key when ready...** is still displayed.

ECHO *remark* displays the given message regardless of whether command line echoing is on or off. The message may be no more than 40 characters long (including spaces).

Examples

- You don't want any of the command lines and messages from your Batch file to appear on the screen. The first lines in your Batch file should therefore be:

```
ECHO OFF
CLS
```

the CLS command clearing the screen ready for displaying the output from your programs.

*The only messages that you will see while ECHO is OFF will be messages contained within special ECHO commands and the **Press any key when ready...** that goes with a PAUSE command.*

To turn the display of messages back on, use the command line:

ECHO ON

Include this in the Batch file immediately before the first command or message that you want to see on the screen.

- To display messages only at strategic stages in the Batch process, begin the Batch file as above with the lines:

ECHO OFF

CLS

At the points in the Batch file you want messages displayed, put lines of the form:

ECHO message

For example, to tell you that Stage I has been completed and Stage II is about to start, you might insert the line:

ECHO Stage 1 finished; Stage 2 begun

FOR

Batch subcommand

FOR %%parameter IN (value[value...]) DO command

FOR is used to execute a number of similar commands.

%%parameter is set to each value listed in the FOR command in turn. This value is then substituted for %%parameter in command and the command that this forms is then executed.

Your PC goes on to execute the next command in the Batch file when the list of values has been exhausted.

Form FOR %%parameter IN (value[value...]) DO command
where parameter is a single character.

Notes Any character may be used as the parameter but digits are not recommended as the parameter in a FOR command because of the risk of confusion between these parameters and the dummy parameters substituted from the command line.

command cannot be another FOR subcommand.

The list of values can include a group of filenames represented by a file name template, created using the wildcards * and ? (see Part I, Section 8.5). In this case, MS-DOS takes as a different value each file in the directory with a matching file name.

Paths cannot be given to files mentioned in the FOR command. So all the files included in the list of values must be in the current directory of the drive.

FOR can also be used outside of any Batch file. In this case, replace %%parameter by %parameter.

Examples

- To make a Batch file, among other things, copy the files OLDDATA.1 and NEWFILE.2 from the default directory to the current directory on Drive C, include the command line:

```
FOR %A IN (OLDDATA.1 NEWFILE.2) DO COPY %A C:
```

This is exactly equivalent to including the lines:

```
COPY OLDDATA.1 C:  
COPY NEWFILE.2 C:
```

- To make the Batch file copy to Drive C first all the files with filenames beginning OLD and then all the files with filenames beginning NEW, include the command line:

```
FOR %A IN (OLD*. * NEW*. *) DO COPY %A C:
```

The files will be copied in the order they appear in the default directory.

-
- To process three programs *FIRST*, *SECOND* and *THIRD* one after another when these all require the same complex command tail, you might include the following line in your Batch file:

```
FOR %%A IN (FIRST SECOND THIRD) DO %%A command-tail
```

This is exactly equivalent to the three lines:

```
FIRST command-tail  
SECOND command-tail  
THIRD command-tail
```

GOTO

Batch subcommand

GOTO *label*

Go to a labelled point in the file

Normally, the commands in a Batch file are obeyed in the order they appear in the Batch file. The GOTO subcommand changes this by directing MS-DOS to go to a labelled point in the Batch file and execute the commands that follow. It can therefore be used:

- to create a loop of commands within the Batch file
- with the IF subcommand, to execute commands only in certain situations

The next command to be executed is the one immediately after the label.

Form GOTO *label*
where *label* is a labelled point in the Batch file.

Notes The point in the Batch file is marked by a colon (:) followed by *label* on a line on their own. This name may not include tab, space or equals characters.

The label may be up to 40 characters long but the first eight characters must be different from the first eight characters of any other label in the file. If the label isn't found, the rest of the Batch file is abandoned.

You can put as many labels into a Batch file as you like. MS-DOS ignores all lines starting with a colon unless it is looking for a label. Lines starting with a colon can therefore be used to space out a Batch file to make it more readable.

Example

Suppose your Batch file contained the label

```
:Stage 2
```

To tell MS-DOS to execute next the command lines that follow this label, insert at the appropriate place in your Batch file the command line:

```
GOTO Stage 2
```

IF

Batch subcommand

IF [NOT] condition command

The IF subcommand is used to make executing a command depend on whether particular statements are true or false.

- **When IF is used, the command is executed if the condition is true.**
- **When IF NOT is used, the command is executed if the condition is false.**

The conditions that can be tested are:

- the value of the exit code set by some programs to record the reason the program finished
- whether a dummy parameter (which may be a parameter representing an environment string) is set to a particular string of characters
- whether a particular file exists

An IF subcommand with a GOTO subcommand as *command* can form a conditional loop in the sequence of commands or conditionally leave out a whole series of commands.

- **Execute command if the condition is true**

Form IF *condition command*

- **Execute command if the condition is false**

Form IF NOT *condition command*

Testable conditions	ERRORLEVEL <i>n</i>	Returns TRUE if the previous command set an exit code of <i>n</i> or greater: otherwise FALSE.
	<i>string1==string2</i>	Returns TRUE if the two strings of characters, however they are represented in the command line, are identical: otherwise FALSE.
	EXIST [<i>d:</i>] <i>filename.filetype</i>	Returns TRUE if the named file is in the current directory on the named drive: otherwise FALSE.

Notes The total command line may not exceed 127 characters (including spaces).

Of the MS-DOS commands, only BACKUP, FORMAT, REPLACE, RESTORE and XCOPY return an exit code. However, your own programs may return exit codes.

The strings that are compared may not include tab, space or equals characters.

The two strings will not be regarded as the same if they have the same characters but don't match in which letters are upper and lower case.

Examples

- To copy the file `OLDDATA.1` on the default drive to Drive C at this point in the Batch process only if the previous command had failed (an exit code greater than 0), use the command line:

```
IF ERRORLEVEL 1 COPY OLDDATA.1 C:
```

- To copy the file `OLDDATA.1` to Drive C only if the previous command has been successful (an exit code of 0), use the command line:

```
IF NOT ERRORLEVEL 1 COPY OLDDATA.1 C:
```

- To check that the file `NEWFILE.2` exists before copying it to Drive C, use the command line:

```
IF EXIST NEWFILE.2 COPY NEWFILE.2 C:
```

- To copy `NEWFILE.2` to Drive C and then rename the original file `OLDDATA.2` at this point only if `NEWFILE.2` exists, you need to divert the processing beyond the command lines to run these programs. You might, therefore, have lines similar to the following in your Batch file:

```
...  
IF NOT EXIST NEWFILE.2 GOTO Diversion  
COPY NEWFILE.2 C:  
REN NEWFILE.2 OLDDATA.2  
:Diversion  
...
```

- To print out the file `OLDDATA.1` using a `COPY` command only if an environment parameter that you have called `PRINTER` is currently set to the string `ON`, your `IF` command needs to compare the value of the parameter `PRINTER` with the string `ON`. Because `PRINTER` is an environment parameter, the string it is set to is represented in the `IF` command by `"%PRINTER%"`, making the command line to use:

```
IF "%PRINTER%"=="ON" COPY OLDDATA.1 PRN
```

PAUSE

Batch subcommand

PAUSE *[remark]*

Pause while processing

PAUSE is used to halt the execution of a Batch file so that you can change disks, for example. The message **Press any key when ready...** is automatically displayed.

If the PAUSE command includes a remark, this is displayed as processing stops. You can use this, for example, to prompt for a specific disk or to remind you to check that the printer is turned on.

Form PAUSE *[remark]*

Notes To continue execution of the Batch file, press any character key – for example, the Space bar. To abandon it, press either Ctrl-Break or Ctrl-C.

The total length of the command line can be up to 127 characters long. There is no restriction on the characters that can be used in the remark.

The remark will not be displayed if the ECHO subcommand has been used to turn off the display of command lines on the screen. However, the standard message continues to be displayed. Use ECHO to display the message in this case.

Example

At the point in a Batch file at which you need to exchange the disk currently in your disk drive for the disk you know as the Records Disk, you might include the command line:

```
PAUSE Insert Records Disk now
```

When the Batch file is processed, what you see on the screen will be:

```
PAUSE Insert Records Disk now  
Press any key when ready...
```

The second part of this message is always displayed – whatever message you set up. Press a character key, such as the Space bar, when you are ready for the Batch process to continue.

REM

Batch subcommand

REM [remark]

Display remark

REM marks the point in the Batch file at which you want a message to be displayed on the screen and lets you set the text of that message. This text is displayed when the Batch process reaches the REM command.

Form REM [remark]

Notes The total length of the command line can be up to 127 characters long. There is no restriction on the characters that can be used in the remark.

The remark isn't displayed if the ECHO subcommand has been used to turn off the display of command lines on the screen. Use ECHO to display the remark in this case.

Examples

- To arrange for the message **Stage 1 finished; Stage 2 started** to appear on the screen at a particular point in the Batch process, you could insert at this point the command line:

```
REM Stage 1 finished; Stage 2 started
```

However, this message won't appear on the screen if you have previously used an **ECHO OFF** command. If you still want to see the message, you should use an **ECHO** command rather than a **REM** command.

- To make the Batch file more readable when you display it, you might make this part of the file:

```
...  
REM  
REM Stage 1 finished; Stage 2 started  
REM  
...
```

Note how **REM** commands have been used to provide space around the 'real' **REM** command.

SHIFT

Batch subcommand

SHIFT

Shift the dummy parameters

SHIFT is used to change what value each dummy parameter in the Batch file has. This lets you work through a list of Batch file parameters.

Each time a SHIFT command is executed, the value of the %0 parameter is replaced by that of %1, the value of %1 is replaced by %2 and so on. The new value for %9 is taken from the command line used to execute the Batch file. The old meanings are forgotten.

This process lets you vary more than ten items within a Batch file (though, you can still only use ten dummy parameters at a time). It also allows you to use one Batch file to process a number of files when this number changes from one time you use the Batch file to the next. There is an example of how to do this in the Examples below.

Form SHIFT

Notes The old values for the parameters are lost.

Examples

- To shift the meanings of the dummy parameters so that %0 takes the current value of %1, %1 takes the current value of %2, etc., include at the appropriate point in the Batch file the command line:

SHIFT

- To shift the meanings of the dummy parameters so that %0 takes the current value of %2, %1 takes the current value of %3, etc., either put at this point in the Batch file:

SHIFT

SHIFT

or use a FOR command, such as:

FOR %A IN (1 2) DO SHIFT

- You want the Batch file MYBAT.BAT to carry out the same sequence of commands on a number of files, one after another. The problem is that the number of files you want to process varies each time you want to use the Batch file.

A possible solution is to make the Batch file just the commands and to run it with each of the files in turn, ie. to enter the following command lines one after another. For example:

```
MYBAT File1
MYBAT File2
MYBAT File3
```

A less tedious option is to give the file the following structure:

```
:LOOP  
IF "%1"==" " GOTO END  
...  
commands  
...  
SHIFT  
GOTO LOOP  
:END
```

The command line to run this would be:

```
MYBAT File1 File2 File3
```

*The first time through the commands %1 would be **File1**, the second time it would be **File2** and the third time it would be **File3**. At the start of the next loop, %1 would be blank and so the **IF** command will direct processing to the label **:END***



5. ORGANISING YOUR WORK

This chapter describes how to make and keep your files readily available for use by:

- **Putting your files into groups**

As you increase the number of files on a disk, you will find that they become much more manageable and more convenient to use if related files are grouped together. MS-DOS then lets you work on just a group at a time.

Section 5.1 of this chapter describes how to

- Display the current pattern of groups on a disk
- Start new groups
- Get rid of groups you no longer need

- **Disk housekeeping**

The selection of files you have on your disks and the way these files are grouped will frequently become out of date. You may well have files you no longer need taking up valuable space on your disk.

The commands in Section 5.2 help you put this right by

- Creating new files
- Making copies of existing files
- Displaying existing files
- Erasing files you no longer need
- Changing what files are called

- **Protecting important files**

Files are readily erased or overwritten. Section 5.3 describes how to protect your most valuable files – programs you have bought, last year's accounts, etc. – against being erased or overwritten accidentally.

5.1 PUTTING FILES INTO GROUPS

Files on DOS media are organised into directories which are themselves organised into a 'tree-like' structure. As you use your PC more, you will want to change the structure of the directories by:

- adding new directories
- removing directories you no longer need

This section describes how to make these changes to the structure.

Note: It isn't possible to change the name of a directory.

Before you make any changes you will need a clear idea of how the directories are already organised. For this, you need to know both how directories are organised in general and how to build up a picture of the tree by working steadily through the directories, moving from each directory to an adjacent one. How directories are organised is described in Part I, Chapter 1 and moving from one directory to another by using the CHDIR command is described in Section 4.1 in this part of the manual. Do read these chapters if you haven't already done so.

5.1.1 Displaying the current pattern of directories

When you want to find out what directories are used on a particular disk and how these are linked together, you can find this out by working your way around the directories on the disk using CHDIR to move from directory to directory (see Section 4.1) and DIR to tell you what is in each directory. If you start at the Root directory and keep a note of the subdirectories within each directory, you can soon build up a tree structure showing how the directories are linked together.

For example, if the Root directory has the subdirectories 'Home' and 'Business', the top part of the tree must be:

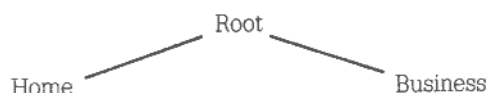

If you change directory to the 'Home' subdirectory, you might find this has the subdirectories 'Letters' and 'Games'. Suppose that when you investigate the 'Letters' and 'Games' directories, you found that neither of these directories had any subdirectories. This would give you the lefthand side of the tree as:

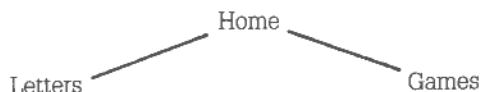

Turning to the righthand side of the tree, you might find that the 'Business' directory contains subdirectories called 'Letters', 'Reports' and 'Accounts' and that 'Letters' had subdirectories 'A', 'B' and 'C' and so did the 'Accounts' directory. If it turned out that neither of the 'A', 'B' and 'C' directories nor the 'Reports' had any subdirectory, your final directory tree would look like this:

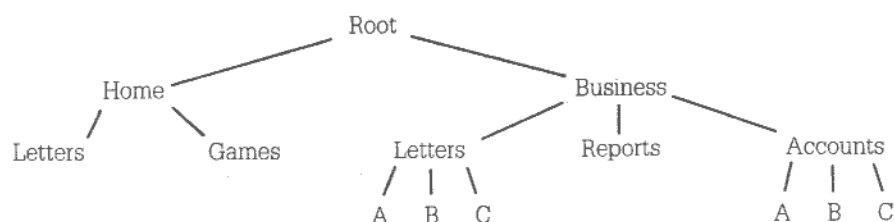

> **TREE** > Working through the directories in this way is not the only method of discovering what directories and how these fit together. You can also use the TREE command, details of which are given at the end of this chapter.

The TREE command gives you a list of all the directories on a disk. This list contains details of the path from the Root directory to each directory listed and the names of the subdirectories in this directory. The process of putting this information together into a tree is very similar to creating a tree from what you find out by working your way around the directory structure.

5.1.2 Adding a new directory

> **MKDIR** > You add a new directory by specifying to MS-DOS where the new directory will fit in. The command used for this is the MKDIR ('Make directory') command.

For example, if the directory structure you start with is like this:

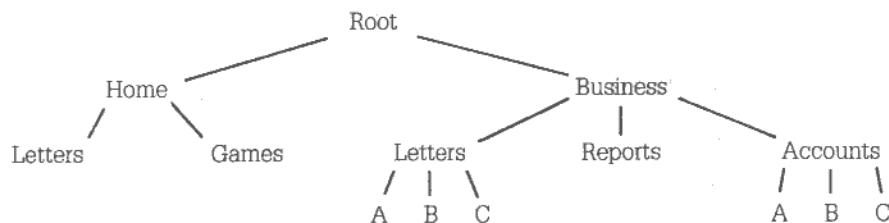

you might want to add a directory to your existing tree for storing the minutes of meetings. There are two things to define about this new directory - where it fits on the tree and its name.

You define where the new directory is to fit in by specifying the path to it

- either from the root directory
- or from the current directory

The last part of the path gives the name of the new directory; the rest of the path specifies an existing directory which will be the new directory's parent. If the parent directory is to be the root directory, all you will need is a backslash before the name of the new directory; if the current directory is to be the parent directory, you will just need to give the name of the new directory.

You can use any valid name for the directory (see Part I, Section 8.6) provided it is not already the name of a child directory of the same parent.

In this case, we will choose the name MINUTES and make BUSINESS its parent.

New tree:

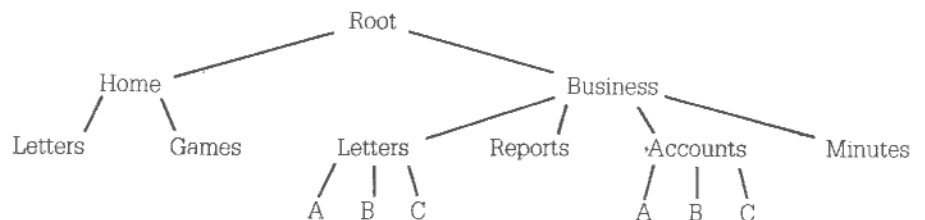

The path from the root directory to the new directory should therefore be written `\BUSINESS\MINUTES` and the command line to create the directory would be:

MKDIR \BUSINESS\MINUTES

When a directory has just been created, it doesn't have any files in it – these have either to be copied to the new directory from other directories or created and stored in the new directory. You would have to use the COPY command (see Section 5.2) to copy a number of files to your new directory if, for example, you already had some Minutes files stored in 'Reports'.

A new directory is always empty of file names but if you list the directory you will see it has two entries. These are `\.` and `\..` and they contain details of the route to the root directory and to the parent directory, respectively. All directories other than the root directory have these entries.

5.1.3 Removing a directory

> **RMDIR** > A directory is removed from the directory structure by using the RMDIR ('Remove Directory') command.

Before you use this command, you have to ensure that

- **there are no files in the directory**
- **any child directory is cleared of files and removed from the directory structure first**

Remember, you can clear a directory with a single DEL command finishing with either a backslash (\) or *.* (see Section 5.2.3). But do take care to clear only the directory you mean to clear!

Note: You cannot (and shouldn't attempt to) clear a directory of the entries `\.` and `\..`. These hold details of the route to the root directory and of the parent directory and cannot be erased.

You also have to ensure before you use the RMDIR command that:

- **the directory you want to remove is not the current directory on the drive**
- **it is not assigned to an imaginary drive (see Section 4.1)**

For example, suppose the directory structure at present is:

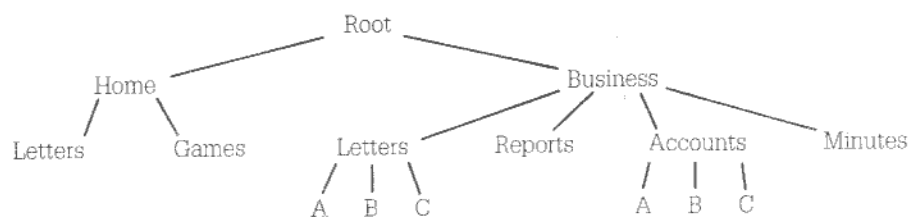

and you wanted to remove Accounts from your directory structure.

You would first have to remove Accounts\A, Accounts\B and Accounts\C. That means you would have to:

- first, erase all the files in these three directories, and
- then, use the RMDIR command to delete the directories themselves

Only after that can you remove the Accounts directory itself.

If you made 'Accounts' the current directory when you were removing the directories 'Accounts\A', 'Accounts\B' and 'Accounts\C', you will now need to change the current directory to some other directory, such as 'Business', before you remove 'Accounts' itself.

5.2 DISK HOUSEKEEPING

Disk housekeeping is about keeping your disks organised, with your files on the 'right' disks and in the 'right' directories. This involves

- **finding out what files are already stored in a directory**
- **adding to these files by creating new files and copying files in other directories**
- **removing files you no longer want, for example to make space for new files**
- **giving files new names**

It isn't possible to simply move a file from one directory (Directory A) to another (Directory B): you always have to make a copy of the original file, store this in the Directory B and then delete the original file from Directory A.

This section looks at the commands needed to find out about the files already stored in a directory, make copies of files, erase files and rename files. Most new files are created by the programs you run but occasionally you will need to create additional files yourself. This is best done with the help of the AMSTRAD PC's text editor RPED (see Part I, Section 7.8). Alternatively, you might use MS-DOS's text editor EDLIN described in the reference part of this chapter. If you are sure you can type the file without mistakes, you can create the file by directly copying what you type into a file. Details of this are given in Section 5.2.1 below.

To use the commands described here effectively, you need to understand about DOS directories. If you aren't certain you do, read Chapter 1 in Part I of this manual before you read any further. You will also need to know what paths are. These are described in Section 4.1. For information on how to make Hard Disk backups refer to Part I, Section 4.

5.2.1 Making copies of files

> **COPY** > You make copies of files to:
> **XCOPY** >

- **give yourself reserve or 'back-up' copies of the files to use when the original file is damaged or accidentally destroyed**
- **move one or more files from one directory to another (the original file is erased once the copy has been made)**
- **create a new file that combines a number of existing files**
- **and, because MS-DOS sees its input and output devices as files, to transfer a file you create at the keyboard into a disk file, output a copy of a disk file on a printer, or transfer what you type at the keyboard to the printer**

The original files are left unchanged by the process.

The MS-DOS commands used to make copies are COPY and XCOPY, details of which are given towards the end of this section. XCOPY will only handle disk files and cannot combine files in the way COPY can, but it can search a directory's subdirectories for the files you want to copy - something that COPY can't do.

Making duplicate copies of disk files

1 Decide on the file or files you want to copy. These are described as your source files.

You can use one command line to copy a number of files provided these can be described by a single file name template (see Part I, Section 8.5) and you don't want to store the copies in the same directory as the original files. If you want to make duplicate copies of files in the same directory, you have to copy the files one at a time.

2 Decide on where you want to store the new files and what they are to be called. This is known as the destination of the copies.

Often you will want to store the copy in a different directory but under the same filename and filetype. Make sure that you don't already have any files with this filename and filetype in your destination directory or, if you do, make sure that you no longer need the files.

It is also wise to check that there will be enough room for the new file on the destination disk. Use the DIR command (Section 4.1) both to find out the size of the files you want to copy and to find out if there is enough room on the destination disk for the new files. The free space on a disk is always given as part of the directory information.

3 Work out how to tell MS-DOS the directory holding the source file(s) and the destination directory.

If you are going to have a sequence of command lines making copies in your destination directory of files in your source directory, it can save you a lot of effort if both directories are current directories.

4 Type in the appropriate COPY or XCOPY command.

If you haven't set up your PC to automatically verify everything that is written to a disk (see Section 4.1), we suggest you use these commands' /V option. This tells MS-DOS to verify that the new file is an exact copy of the original file and that it can be read back by checking, for example, that it doesn't have any bad sectors in it.

The new file - the Destination file - is completely independent of the source file once the copy has been made and can be sent to any part of your system.

Transferring files to and from Input and Output Devices

Transferring information:

- from an Input Device such as the keyboard into a disk file
- from a disk file to an Output Device such as the display or the printer
- from an Input Device to an Output Device

are all copy operations. They use COPY commands very like those used to copy disk files between different drives, but with an Input Device as the Source for the copy and/or an Output Device as the Destination.

The way of telling MS-DOS that, for example, the keyboard is the source and the printer is the destination is simply to put its device name in the relevant position in the COPY command. The keyboard's name is CON and the printer's name is LPT1, and so the command line you would need in this instance would be:

COPY CON LPT1

Once you have given this command, everything you type in at the keyboard will simply be printed out on the printer until you type Ctl-Z.

Similarly, you could tell MS-DOS to transfer information it receives through the Serial Interface (known to your computer as AUX) to the disk file called TRANSFER.DAT with the command line:

COPY AUX TRANSFER.DAT

The device names associated with the AMSTRAD PC's input and output devices are listed in Appendix IV.

Combining a number of files into one large file

The COPY command also allows the data from a number of sources – disk files, the keyboard, the serial interface – to be combined into a single file in one copying process. The files that are combined do not have to be stored on disk: one of the files could be input from the keyboard and another could be input from the serial interface.

The resulting file can either be a new file or the first of the source files, with the information from the other files appended to the end of this file. The other source files are not affected by the copying process.

Details of the commands that combine files in this way are given in the full description of the COPY command towards the end of this chapter.

5.2.2 Examining text files

- > **TYPE** > Many files can only be interpreted by the program that uses them and so using the file is often the only way of checking up on what the file contains. However, text files – that is, files of ASCII characters that are entirely free of special program codes – can readily be displayed on your screen or printed out on a line printer. Trying to display non-text files in this way will only result in output that is impossible to read.
- > **PRINT** >

The commands used to display text files are TYPE and PRINT. The TYPE command is used to display the text file on your PC's screen; the PRINT command is used to output the file on a printer attached to your PC.

The TYPE command can only display one file at a time and unless you make the display pause, for example by using the MORE filter (described in Section 4.3), much of the file will be scrolled off the screen before you have time to read it. However, it provides a simple and quick way of checking whether a particular text file contains what you thought.

The PRINT command can be used to print either one or a number of files. It sets up a list of files that are to be printed and sends these to the printer in the background while you get on with doing other jobs.

You cannot change any of the files that are waiting to be printed and you must not take the disk they are stored on out of the drive until all the files have been printed.

However, you can change the list after the files have started being printed. You can:

- **add new names to the end of the list**
- **remove the names of files you no longer want to print**
- **abandon the rest of the print list**

How this is done is covered at the end of this chapter, where the PRINT command is described in detail.

5.2.3 Deleting files

> **DEL** > Unwanted files will clutter up your disk space unless you delete them. Deleting a file reclaims the space the file occupied both in the directory and on the disk, freeing it for use for some other file. Files aren't deleted if:

- they are not in the current directory of the disk
- they are write-protected

The command to use is DEL or ERASE. ERASE is the alternative name for the DEL command.

Once a file is deleted, it cannot be recovered, so it is important that only files you don't want are deleted. The way to ensure this is to write-protect all important files (see Section 5.3).

This is especially important if you plan to delete a number of files by giving a file template constructed using the wildcards * and ? (see Part I, Section 8.5). MS-DOS only asks you if you are sure you want to delete every file that matches the template if you ask to delete all the files in a directory. In all other cases, you could discover that your template matched a file you didn't mean to delete.

5.2.4 Renaming files

> **RENAME** > Files do not have to keep the names they were given when they were created. The names can be changed at any time to any other valid filename by using the RENAME command. However, you mustn't use a name that has already been given to another file or to a directory within the same directory.

Renaming a file doesn't affect the contents of the file in any way; it just changes the filename recorded in the directory. Because of this, renaming cannot move a file from one directory to another, even on the same disk: to do that, you have to make a copy in the new directory and then delete the old version.

5.2.5 Comparing files

> **COMP** > If you have a number of versions of the same file, you may want to find out exactly what the differences are between these versions.

The command to use is the **COMP** command, which will compare files for you either line-by-line or byte-by-byte. You would opt for:

- **line-by-line comparisons to compare versions of a word-processor document or a BASIC program**
- **byte-by-byte comparisons to compare versions of a machine-code program**

Starting at the beginning of the two files, **COMP** matches each line or byte of one file against the corresponding line or byte of the other file. When **COMP** spots a difference, it carries on comparing until the two files match again: the whole section that is different is then either output on the screen or sent to a file.

Because inserting or deleting lines is a common change to make to documents or BASIC programs, **COMP** tries to 'resynchronise' files it is comparing line-by-line. It will keep reading lines into its buffer from each file until it matches a line from one file with a line from the other - or the buffer is filled up. If the buffer becomes full, **COMP** gives up comparing the files and declares the files 'too different'. No such attempt is made to resynchronise files that are being compared byte-by-byte.

5.2.6 Finding out how much room there is on a disk

As you create, copy, edit and delete files on a disk, you may want to check how much storage space is currently available on the disk. (When you edit a file you typically need at least as much free space on the disk as the size of the file, and it is wise to check this **before** you start editing the file.)

The easiest way of getting this information is to use the **DIR** command (see Section 4.1) to display details of a directory or even of a single file on the disk. At the bottom of the display will be quoted the number of bytes free on the disk. (1000 bytes will hold about 1000 characters.)

Compare this number with the size quoted for the file you want to copy onto the disk or the size of the file you want to edit, before deciding to go ahead.

5.3 PROTECTING YOUR FILES

As you store programs and data in files, there are a number of questions you should give some thought to:

- **Will you want to maintain a security copy of the file?**
- **Do you want to protect the file against being accidentally deleted or overwritten?**
- **Will you want to know when the file was last changed?**

These questions are all ones of file security and we strongly recommend you to pay attention to this aspect of using your PC. In particular, we would advise you to make security copies of your valuable files. If you do this regularly, you may not need to take any other steps to protect your files.

5.3.1 Making security copies

You will want to keep security copies of most of your files, for use in case of accident. The process of creating such copies is known as 'backing up'.

There are a number of possible ways of making back-up copies of files:

- you can make copies of whole disks, by using the DISKCOPY command (see Chapter 6) or the XCOPY command (see Section 5.2);
- you can copy individual files onto a different disk, by using the COPY command or the XCOPY command (see Section 5.2).

5.3.2 Controlling the creation of security copies

If you have a group of files you back up regularly, it saves you time if you only backed up those files in the group that had been changed since the last time you backed the files up. You will want to do this whether you created your security copies, by using a XCOPY command, by using a DISKCOPY command or a number of COPY commands.

You get the required control when using the XCOPY command through its **/A** and **/M** options.

- > **REPLACE** > To get a similar effect when your disk was created by a DISKCOPY or several COPY commands, you need to use the REPLACE command. The **/D** option of this command limits the files it updates to those that have been changed since the copy was made.

Other options offered by the REPLACE command include:

- **spotting brand new files and selectively adding these to the set on the back-up disk**
- **updating write-protected files as well as unprotected files**

> **ATTRIB** > From time to time when using the XCOPY command, you may want to include in the back-up a particular file even though it hasn't been changed, or to exclude a file even though it has been changed. For this, you need to change the file's Archive attribute with the ATTRIB command. (An attribute is a kind of switch on a file which can be set to 'On' or 'Off.')

- If you want the file to be backed-up, you should set the switch to On (+A)
- If you don't want the file to be backed-up, you should set the switch to Off (-A)

5.3.3 Protecting against accidental deletion

> **ATTRIB** > When a file is created it is a Read-Write file. This means you can:

- read it
- change it
- delete it

This in turn means you can accidentally destroy it! Although you wouldn't deliberately delete a file you knew you wanted, you might temporarily forget that it contained important information or you might delete it alongside a group of other files with similar filenames.

The way to ensure that your important files are not lost through being accidentally overwritten or deleted is to make them Read-Only files. This says that the files:

- can be read into the computer's memory and processed
- but the versions stored on the disk cannot be overwritten nor can they be erased.

The files are then said to be Write Protected, and they stay write-protected until you make them Read-Write again.

Use the ATTRIB command to make a file Read-Only - and to make it Read-Write again.

5.3.4 Monitoring when files are changed

MS-DOS helps you monitor when your files are changed by Time and Date Stamping the files to show when the files were last updated. These times are recorded automatically for your DOS files, and can be displayed when the directory is listed using the DIR command (see Section 4.1).

One use of the time and date stamps is to spot how out of date a copy of some file is. If the time and date recorded for the copy is a long time before that of the version you are currently using, the chances are that the copy is not up to date.

You may also want to take advantage of the time and date stamping if you are one of a number of people using the same data files and you want to know whether a particular file has been changed since the last time you used it. The time and date stamps would quickly tell you whether a file had been changed.

If you use time and date stamping, you need to keep your PC's internal clock set correctly. The clock setting is held in a part of the AMSTRAD PC's memory that is powered by batteries and so keeping the clock right means

- either** changing the batteries regularly before they go flat (say, once a year)
- or** renewing the batteries the moment the clock is reset to 1 January 1980 and then using the DATE and TIME commands to reset the clock (see Section 7.3).

ATTRIB

External command

ATTRIB [+R|-R] [+A|-A] [d:][\][path\]filename.filetype

Set file attributes

The ATTRIB command is used to set a file's Read-Only and Archive attributes. These respectively control:

- whether Read-Write or just Read-Only access is allowed to the file
- whether the file is to be backed-up

The attributes that are set depend on which of the R and A options are selected. If no option is selected, MS-DOS displays the attributes that are currently set.

All files are created allowing Read-Write access, ie. with the Read-Only attribute cleared. Setting this attribute allows just Read-Only access to the file until this attribute is cleared through another ATTRIB command.

The Archive attribute is set when you change a file and cleared when the file is backed-up. Setting the Archive attribute with an ATTRIB command makes the file **appear** to have been changed and it will be backed-up by the next XCOPY command even though it hasn't been changed. Clearing this attribute makes the latest version of the file appear to have been backed-up and so it won't be backed up by the next XCOPY command even though it has been changed.

● To set attributes

Form ATTRIB [+R|-R] [+A|-A] [d:][\][path\]filename.filetype

Options

+R	Make the file Read-Only
-R	Make the file Read-Write again
+A	Force the file to be backed-up even if it hasn't been changed
-A	Stop the file from being backed-up even though it has been changed

● To display attributes

Form ATTRIB [d:][\][path\]filename.filetype

Notes You can use a file name template, constructed using the wildcard characters * and ? (see Part I, Section 8.5) to display the attributes of a number of files simultaneously.

Examples

- To make the file *MYFILE.TXT* in the default directory Read-Only, use the command line:

```
ATTRIB +R MYFILE.TXT
```

(assuming that the external command *ATTRIB* is stored either in the default directory or in a directory that MS-DOS automatically searches – see Section 4.2.4)

If *MYFILE.TXT* is in a different directory, for example *\DIR1* (a subdirectory of the Root directory), the command line would be:

```
ATTRIB +R \DIR1\MYFILE.TXT
```

- To make *MYFILE.TXT* Read-Write again, use the command line:

```
ATTRIB -R MYFILE.TXT
```

if it is in the default directory or, if it is in *\DIR1*, use:

```
ATTRIB -R \DIR1\MYFILE.TXT
```

- To ensure that the file *MYFILE.TXT* in the default directory will be processed by the next *XCOPY* command, set the file's Archive attribute with the command line:

```
ATTRIB +A MYFILE.TXT
```

To stop it being processed, clear the file's Archive attribute with the command line:

```
ATTRIB -A MYFILE.TXT
```

If the file is in *\DIR1* (a subdirectory of the Root directory), clear its Archive attribute by using the command line:

```
ATTRIB -A \DIR1\MYFILE.TXT
```

- Display the attributes of all the files in the default directory with the command:

```
ATTRIB *.*
```

Displayed on the screen would be something like this:

```
A>attrib *.*
```

```
R      A:\SPREAD.COM
A      A:\SPREAD.DAT
A      A:\RECORDS.OLD
A      A:\RECORDS.NEW
```

- Display the attributes of all the *.TXT* files in *\DIR1* (a subdirectory of the Root directory) with the command:

```
ATTRIB \DIR1\*.TXT
```

COMP

External command

COMP [option[option...]] [d:][\][path\]filename.filetype [d:][\][path\]filename.filetype

Compare files

The COMP command is used to compare two files. Note that it is not possible to use filename templates with two sets of files.

The files for comparison are:

- **either** treated as text files and compared line-by-line
- **or** treated as binary files and compared byte-by-byte

When a difference is found between two text files, COMP reads on looking for lines from the two files that match. Unless instructed otherwise, tab characters are converted to spaces up to the start of the next 8-character column before the comparison is made. When COMP finds two consecutive lines in one file that match two consecutive lines in the other, it 'resynchronises' the comparison and carries on to the next place in the files where it finds a difference. No attempt is made to resynchronise files compared byte-by-byte.

COMP can only read on so far. All the lines it is trying to match are stored in an area of your PC's memory described as the COMP command's buffer. If the buffer becomes full before any match has been found, COMP declares the files 'too different' and ends the comparison. You can control how big this buffer is.

What type of comparison is made is controlled by which options are selected. If no options are specified:

- files with the filetype EXE, COM, SYS, OBJ, LIB and BIN are treated as binary files; everything else is treated as a text file.
- the size of the buffer used for the comparison is set to 100 lines
- tabs, spaces and upper and lower case in a text file are all significant
- two lines of the text file have to be identical for the comparison to resynchronise

The way COMP reports the differences is shown through the examples at the end of this description.

● To compare files line-by-line

Form COMP [option[option...]] [d:][\][path\]filename.filetype [d:][\][path\]filename.filetype
File to be compared 'Standard' for comparison

Options /A	To indicate where the difference is, just display the last line of the previous matching section and the first line of the following matching section - not all the lines in between. (The lines in between are represented by ...)
/C	Treat all letters as upper case in the comparison.
/L	Force a line by line comparison. (Used when the filetype of either file is EXE, COM, SYS, OBJ, LIB or BIN.)
/LBn	Set the buffer size to n lines. (The default is 100 lines; the maximum depends on the amount of memory space your PC has.)

/N Add line numbers when reporting where the differences are.
/T Don't expand tab characters to spaces. (The default is to interpret each tab character as spaces up to the start of the next 8-character column.)
/W Interpret all tabs and multiple spaces as single spaces; ignore spaces at the beginning and the end of any line.
/n Set the number of identical lines required before the comparison resynchronises to *n*. (The default is 2 lines.)

Notes If the number of consecutive lines that are different is greater than the buffer space, COMP won't be able to resynchronise the comparison. If this happens, the message **Resynch failed. Files are too different** will be displayed and then the comparison will be abandoned. Use the **/LBn** option to increase the size of the buffer before comparing these files again.

You can't use the **/B** option of a byte-by-byte comparison in a line-by-line comparison. If you try this, MS-DOS will display the message **Incompatible switches**.

● **To compare files byte-by-byte**

Form COMP **[/B]** [d:][\][path\]filename.filetype [d:][\][path\]filename.filetype
The file being compared 'Standard' for the comparison

Notes The **/B** option should be used to force a byte-by-byte comparison if either of the files does not have the filetype EXE, COM, SYS, OBJ, LIB or BIN.

No attempt is made to resynchronise the comparison after a difference has been spotted.

Examples

- To compare line-by-line the two text files, MYFILE.1 and MYFILE.2, you might use the command line:

COMP MYFILE.1 MYFILE.2

(assuming that the external command COMP is stored either in the default directory or in a directory that MS-DOS automatically searches - see Section 4.2.4)

This would compare each line letter for letter, space for space with any tab characters expanded to spaces such that the next character began the next 8-character column. If MYFILE.2 was identical to MYFILE.1 except for four additional lines, you might see a report like this:

```

A>comp myfile.1 myfile.2
**** myfile.1
When the hurly-burly's done
When the battle's lost and won
That will be ere set of sun
And where the place
Upon the heath
**** myfile.2
When the hurly-burly's done
Upon the heath
****
  
```

Examples

- To copy a file called *MYFILE.TXT* in the current directory on the default drive to the current directory on Drive B and store it with the same filename and filetype, use the command line:

COPY MYFILE.TXT B:

To store the copy under the name *YOURFILE.TXT*, use the command line:

COPY MYFILE.TXT B:YOURFILE.TXT

- To copy all the files that match the file name template *YOUR*.** in the default directory to the current directory on Drive B and store them with the same names but with *YOUR* replaced by *MY*, use the command line:

COPY YOUR*.* MY*.*

Be sure in making such a copy that none of the new names will be invalid, ie. that your new template doesn't lead to filenames more than 8 characters long or filetypes more than 3 characters long.

- To copy the file *MYFILE.TXT* as above but this time store the new copy with a new date and time stamp, use the command line:

COPY MYFILE.TXT+,, B:

- To use the *COPY* command to print out the file *MYFILE.TXT*, use the command line:

COPY MYFILE.TXT PRN

- To take input from the Serial Interface and place this in the file *NEWFILE*, use the command line:

COPY AUX NEWFILE

All the data input through the Serial Interface will be put into this file until a Ctrl-Z character is sent. This signals the end of the file.

- To combine the files *MYFILE.1* and *MYFILE.2* in a new file called *NEWFILE*, use the command line:

COPY MYFILE.1+MYFILE.2 NEWFILE

- To append *MYFILE.2* to *MYFILE.1*, use the command line:

COPY MYFILE.1+MYFILE.2

- To append data input through the Serial Interface to *MYFILE.1*, use the command line:

COPY MYFILE.1+AUX

All the data input through the Serial Interface will be added to the file until a Ctrl-Z character is transmitted, signalling the end of the file.

DEL ERASE

Internal command

```
DEL [d: ][\][path\]filename.filetype  
ERASE [d: ][\][path\]filename.filetype
```

Delete a file

DEL and ERASE are used to remove one or (by using a file name template) many files from a directory, freeing both directory space and data storage space for future files.

Once a file has been deleted, it cannot be retrieved.

Form DEL [d:][\][path\]filename.filetype
ERASE [d:][\][path\]filename.filetype

Notes If you use the file name template *.* (or equivalent) – implying that you want to erase all the files in the directory – MS-DOS asks you to confirm that you want to delete all these files by displaying the message:

Are you sure (Y/N)?

Type **Y** to delete all the files; **N** to cancel the command.

This is the only instance in which you are asked to confirm the command before files are erased. Any other file name template causes all Read-Write files with names that match the template to be deleted immediately.

Examples

- To delete a file called OLDDATA.1 in the default directory, type either the command line:

```
DEL OLDDATA.1
```

or

```
ERASE OLDDATA.1
```

These command lines are exactly equivalent.

If the file you wanted to delete was in the current directory on Drive C, your command line would become:

```
DEL C:OLDDATA.1
```

- To clear the \DIR1 directory (a subdirectory of the Root directory on the default drive) of all the files stored in it, you might use the command line:

```
DEL \DIR1\*.*
```

Following this command, you will see the message:

Are you sure (Y/N)?

*Type **Y** to delete all the files; type **N** to abandon this action.*

These commands won't necessarily clear the directory completely: any subdirectories will be unaffected.

EDLIN

Text editor

EDLIN [d:][\][path\]filename filetype[/B]

Edit text

EDLIN is MS-DOS's text editor and can be used to modify files of ASCII characters (ie. text files), whether these are data files or BASIC programs. It can also be used to create new text files for storage on disk.

It can be used as an alternative to the AMSTRAD PC text editor, RPED (see Part I, Section 7.8).

EDLIN opens an area of memory to act as a workspace and looks for the file you specify in the command line. If it finds the file, EDLIN copies the file into its workspace ready for editing - filling up to three-quarters of the workspace area. Any remainder can only be read into the workspace after the previous section has been edited and stored as the new version. If all the text is copied into the workspace, the message **End of input file** will appear on the screen. If EDLIN doesn't find the file, it displays the message **New file**. In either case, it will display a star on a fresh line when it is ready to receive editing commands. This star is the EDLIN prompt.

While you are in the editor, the commands you use are the special EDLIN ones: you cannot use any MS-DOS commands until you leave the editor. However, you can use the Command Line Editing keys (see Section 4.2) to help you prepare new lines based on existing lines of text.

The EDLIN commands copy text into and out of the workspace, edit particular lines and insert or delete groups of lines. There are also commands to move a group of lines from one place to another, to duplicate lines and to search and replace strings of characters. The commands are listed below. The lines you edit are displayed preceded by a line number which tells you how many lines down the file you are working. These numbers are kept constantly up to date and are not saved with the file. The current line you are working on is indicated by a star and line numbers may be given relative to this line (see 'Defining lines' below).

A number of EDLIN commands can be typed in one after another before the Return key is pressed to send the instruction for processing. The first command in a command line can be a line number, changing which line is the current line: the remainder have to work with whatever current line has been set. If the combined instruction starts with a line number, the individual commands must be separated by semicolons. If the instruction doesn't start with a line number, the commands can be typed in without semicolons (or any other separators) between them.



When you want to finish the edit and save the edited version, type **E**  after a * prompt. However, if there isn't enough room for both the new version and the old version of the file (the back-up) on the disk, the new version will either be completely lost or only part of it will be saved. It is therefore advisable to check that there is enough room for both the old and new versions of the file on the disk (see Section 4.2.5).

The modified file is given the *filename* and *filetype* of the original file. However, the original file is not erased. Instead, it is renamed *filename.BAK* (replacing any file that already exists with that name). Should you want to use the old version again, you will need to give it some other filetype as many commands (including EDLIN) do not work on **.BAK** files.

Form EDLIN [d:][\][path\]filename.filetype[/B]

Notes The optional /B is used to tell EDLIN not to interpret Ctrl-Z characters as ends-of-files.

EDLIN commands

- n* Edit Line *n* (if omitted, it is taken to be the next line). Line *n* becomes the current line and is displayed, followed by a fresh line with the same line number. The Command Line Editing keys can then be used to construct a new line based on the present version of this line.
- If you don't want to change the line, just press  - pressing  when you have copied some of the old line into the new one will delete everything to the right of the current cursor position.
- [*n*]A Append *n* of the lines of text that haven't so far been copied into the workspace to the end of the text currently in the workspace. If *n* is omitted, as many lines as possible will be copied but once again, the workspace is not allowed to become more than three quarters full.
- [*n*],[*m*],[*c*]C Copy a range of lines to a different part of the file.
- n* specifies the first line to be copied (if omitted, it is taken to be the current line).
- m* specifies the last line to be copied (if omitted, it is taken to be the same as *n*).
- l* specifies the line before which the copy is to be inserted (which can't be between *n* and *m*).
- c* specifies the number of copies to be inserted at this point (if omitted, one copy is made).
- [*n*],[*m*]D Delete a range of lines.
- n* specifies the first line to be deleted (if omitted, it is taken to be the current line).
- m* specifies the last line to be deleted (if omitted, it is taken to be the same as *n*).
- E End the edit, save the new file and return to MS-DOS.
- [*n*]I Insert the following lines immediately before Line *n*. If *n* is omitted, the lines are inserted before the current line; if *n* is #, the new text will be inserted after the last line currently in the workspace.
- Type Ctrl-C after you have typed in the last new line.
- To insert control codes in the file, type Ctrl-V followed by *character*, where the code you want, is Ctrl-*character*

[n][,m]L

List a range of lines.

n specifies the first line to be displayed on the screen (if omitted, it is taken to be 11 lines before the current line).

m specifies the last line to be displayed (if omitted, 23 lines are displayed).

[n],m,M

Move a range of lines to a different part of the file.

n specifies the first line of the range (if omitted, it is taken to be the current line).

m specifies the last line of the range.

The lines are inserted immediately before Line *l*.

[n][,m]P

Display a range of lines in pagefuls of 23 lines at a time. The last line becomes the new current line.

n specifies the first line to be displayed (if omitted, it is taken to be the current line).

m specifies the last line to be displayed (if omitted, 23 lines are displayed).

Q

Quit the edit, abandoning any changes made so far, and return to MS-DOS. EDLIN asks you to confirm that you don't want to save the edited version. Type **Y** to abandon the edit. Pressing any other key keeps you in EDLIN and allows you, for example, to End the edit and thus save the edited version.

[n][,m][?]R*old-string*[Ctrl-Z][*new-string*]

Replace all occurrences of *old-string* in a range of lines with *new-string*. If *new-string* is omitted, EDLIN will delete *old-string* (ie. it won't replace it with anything). If both Ctrl-Z and *new-string* are omitted, *old-string* will be replaced by the last *new-string* you used.

n specifies the first line of the range (if omitted, it is taken to be the line following the current line).

m specifies the last line of the range (if omitted, it is taken to be the last line in the workspace).

Including **?** makes EDLIN ask for confirmation before replacing the current instance of *old-string* with *new-string*. Press **Y** or to confirm the change.

[n][,m][?]S*string*

Search for the first occurrence of *string* in a range of lines.

n specifies the first line to be searched (if omitted, it is taken to be the line following the current line).

m specifies the last line to be searched (if omitted, it is taken to be the last line in the workspace).

Including **?** makes EDLIN ask if it has found the instance of string you wanted (the whole line is displayed on the screen). Press **Y** or **←** to stop the search; press any other key to continue the search.

Note: This must be the last command in the current instruction.

[/][d:][\][path\]filename filetype
Transfer the whole of the named file into the workspace, inserting it immediately before Line *l*. If *l* is omitted, it is inserted before the current line.

[n]W
Write the first *n* lines in the workspace to the disk. If *n* is omitted, enough lines are copied to make the workspace only one quarter full.

Defining lines There are a number of ways in which particular lines can be specified in these commands.

<i>line-number</i>	the actual line number. Note: Give any number that is greater than the last line number but less than 65534 to get the line immediately following the last line.
+number-of-lines	the number of lines the chosen line is after the current line
-number-of-lines	the number of lines the chosen line is before the current line
.	the current line
#	the last line

Example

You can make the running of any program particularly convenient by including the instruction to run the program in the AUTOEXEC.BAT file of your Startup disk. The necessary changes can be made to the AUTOEXEC.BAT file using EDLIN.

For example, suppose you have a two-drive system and you want to run Locomotive BASIC 2 simply by placing the GEM Startup disk in Drive A and your BASIC 2 disk in Drive B. This involves adding the command `PATH B:\BASIC2` to the AUTOEXEC.BAT file and changing the final line to `GEM BASIC2.APP`.

The steps are as follows:

1. Start editing the AUTOEXEC.BAT file with the command line:

```
EDLIN B:AUTOEXEC.BAT
```

When this file is ready for editing, you will see on the screen:

```
End of input file
```

2. Press the [L] key. This displays the whole of this short file on your screen. You will see something very like:

```
1: copy command.com c:
2: set comspec=c:\command.com
3: copy gem.bat c:
4: c:gem
```

3. The PATH instruction has to be inserted before line 4, so type:

```
4I [←]           - to start inserting the new line
path b:\basic2 [←] - this is the text of the new line
Ctrl-Z           - to end the insert
```

4. Press the [L] key to see the effect of these actions. You should see something very like:

```
1: copy command.com c:
2: set comspec=c:\command.com
3: copy gem.bat c:
4: path b:\basic2
5: c:gem
```

5. The next stage is to modify the last line, so type or press:

```
5           - to start editing line 5 (the current line number of
             the last line)
[F3]        - to copy the whole of the old line into the new line}*
Space bar   - to put a space after gem
basic2.app  - to finish the new line
```

* If gem is followed by %1 %2 %3, press [F2] instead of [F3] and then type %

6. Press the [L] key to see the effect of all these actions. You should see something very like:

```
1: copy command.com c:
2: set comspec=c:\command.com
3: copy gem.bat c:
4: path b:\basic2
5: c:gem basic2.app
```

7. Press the [E] key to finish the edit.

MKDIR

Internal command

MKDIR [d:][\]path

Make a new directory

MKDIR adds a new directory to the directory structure on a particular DOS disk. The path to the new directory is defined through existing directories either from the disk's root directory or from the drive's current directory. The new directory is attached to the existing directory specified by all but the last section of the path.

MKDIR can be abbreviated to MD.

Form MKDIR [d:][\]path
or MD [d:][\]path

Notes Include the optional backslash if the path starts at the root directory. If the path starts from the current directory, leave this backslash out.

Examples

Suppose you wanted to create the following pattern of directories on a new disk, which you have placed in the default drive:

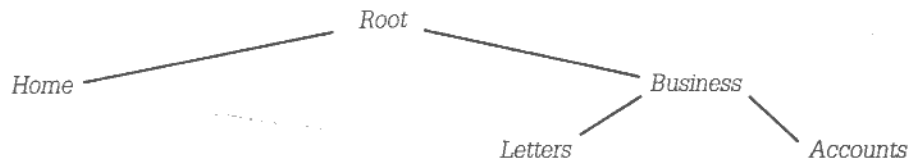

- To create the Home and Business directories (both subdirectories of the Root directory) you would use the command lines:

```
MD \HOME  
MD \BUSINESS
```

- To create the Letters and Accounts directories – subdirectories of the Business directory, you could either use the command lines:

```
MD \BUSINESS\LETTERS  
MD \BUSINESS\ACCOUNTS
```

or you could change the current directory to the \BUSINESS directory and then create its subdirectories, with the command lines:

```
CD \BUSINESS  
MD LETTERS  
MD ACCOUNTS
```

Notice that you don't put a backslash in front of LETTERS or ACCOUNTS, to show that these are to be subdirectories of the current directory. If you had put a backslash, the new directories would have been formed in the Root directory.

- *If, at a later date, you forget that you have created the Accounts directory, you might type the command:*

MD \BUSINESS\ACCOUNTS

Because this directory already exists, you will see the message:

Unable to create directory

This message would also appear if you have a file called ACCOUNTS in the Business directory.

Set-up options /D: *device*

Specifies the device name used for your printer. (The default is PRN.) **Note:** this option must be listed first.

If you don't include this option, MS-DOS displays the message **Name of list device [PRN]:** and gives you the opportunity to specify a different output device. If you have a parallel printer, just press the **[←]** key. If you have a serial printer, give the device name **AUX**.

/B: *buffer-size*

Sets the size of the print buffer. The default is 512 bytes. As a general rule, a bigger buffer improves the performance of the PRINT command.

/Q: *queue-size*

Sets the number of files you can have waiting to be printed (between 1 and 32). The default is 10 files.

/S: *time-share*

Sets how much computer time is devoted to your foreground task compared with that used on printing in the background. The value you set must be between 1 and 255.

The default is 8, ie. your PC devotes eight times as much effort to programs you use while the files are being printed as it does to printing the files. As a result, your files will take roughly nine times longer to print than they would have done if printing was the only job your PC was doing.

/U: *busyticks*

Sets how long your PC will wait for the printer to become ready to receive more data to print before going back to working on your foreground task. The default is 1 processor clock-cycle.

/M: *maxticks*

Sets the maximum length number of processor clock-cycles your PC will spend sending data to the printer before going back to working on your foreground task (between 1 and 255). The default is 2 clock-cycles.

Notes Be careful only to name an output device attached to your PC as the output device for the PRINT command.

Once the PRINT command has been used, the amount of memory available for running your programs is reduced until the next time you reset your PC.

If you try to use any of the set-up PRINT options in a subsequent PRINT command, the command will fail and MS-DOS will display the message **Invalid parameters**.

Subsequent occasions

● **To change the list of files to be printed:**

Form PRINT [d:][\][path\]filename.filetype/P|/C [[d:][\][path\]filename.filetype[
/P|/C]...]

Options /C Remove this and following files (up to the next file listed with the /P option) from the list of files waiting to be printed.

/P Add this and following files (up to the next file listed with the /C option) to the list of files waiting to be printed.

- **To abandon printing the current list**

Form PRINT /T

Note If a file is currently being printed when this command is entered, a cancellation message will be printed. The paper is then advanced to the next page.

Examples

- To print the file MYFILE.TXT on the default drive, accepting all the default settings, use the command line:

PRINT MYFILE.TXT

(assuming that the external command PRINT is stored either in the default directory or in a directory that MS-DOS automatically searches – see Section 4.2.4)

If this is the first time you have used the PRINT command since switching on or resetting your PC, the following message will appear on your screen:

Name of list device [PRN]:

This message won't appear if you have already used a PRINT command.

If you have a parallel printer, just press . If you have a serial printer attached to the Serial Interface, type **AUX** or **COM1** before pressing .

- To set up a print queue of all your .TXT files (12 files in all) as your first PRINT job since switching on, use the command line:

PRINT *.TXT/Q:12

You need the /Q option because otherwise PRINT will cut short your print queue at 10 files.

If you have already used a PRINT command but with the standard print queue, you will need to reset your PC (, ,) before using this command line.

You mustn't change the disk in the default drive while these files are being printed, nor can you modify any file before it has been printed, but you can do other work while the files are being printed.

- To abandon all the print queue after printing has started, use the command line:

PRINT /T

- If, after you have entered the command to print all your .TXT files, you decide that you didn't want to print the file MYFILE.TXT, you can remove this file from the list with the command line:

PRINT MYFILE.TXT/C

If you didn't want to print any file that matched the file name template MY*.TXT, you remove all these files with the command line:

PRINT MY*.TXT/C

If one of these files was being printed when you typed this command line, a cancellation message will be printed before PRINT goes on to print the next file in the list.

-
- *If, after starting printing, you decide to add the file MYFILE.BAS to the list of files to be printed, use the command line:*

PRINT MYFILE.BAS/P

This file will be added to the list, provided there is room in the print queue for this additional file.

If you decide both to remove all the MY.TXT files from the print queue and add MYFILE.BAS, you can do this with the command line:*

PRINT MY*.TXT/C MYFILE.BAS/P

Be careful to include the /P at the end of the command line or MS-DOS will try to remove MYFILE.BAS from the current print queue.

RENAME

Internal command

RENAME [d:][\][path\]old-name new-name

Rename a file

RENAME is used to change the name of a file or a group of files. Renaming a file does not change its location on disk.

RENAME can be shortened to REN.

Note: You cannot rename a directory. The only alternative is to create a directory with the new name and copy all the files in the current directory to the new directory.

Form RENAME [d:][\][path\]old-name new-name
or REN [d:][\][path\]old-name new-name
where old-name is: filename.filetype
new-name is: filename.filetype

Notes The wildcard characters * and ? may be used to specify a group of files in the same directory (see Part I, Section 8.5). However their use in giving the new file template must be identical to their use in giving the old file template.

If a file already exists with the same file name as the new file name, then renaming will be abandoned. The message **File not found** will be displayed on the screen.

Examples

- To rename the file NEWDATA.1 in the default directory OLDDATA.1, use the command line:

```
REN NEWDATA.1 OLDDATA.1
```

If the file was in the \DIR1 directory on Drive C (a subdirectory of the Root directory), the command line would be:

```
REN C:\DIR1\NEWDATA.1 OLDDATA.1
```

Notice that you don't have to repeat the drive and directory information.

- To rename all the MYFILE.* files in the default directory YOURFILE.*, use the command line:

```
REN MYFILE.* YOURFILE.*
```

The use of the wildcards * and ? in the new names must be identical to its use in the old names.

REPLACE

External command

REPLACE *source-drive:* [\][path\]*filename.filetype target-drive:* [\][path][
option[option...]]

Replace old versions and insert new files

The REPLACE command is used to keep back-up disks up to date by:

- replacing old files on your back-up disk with the newest versions of the files
- adding to your back-up disk files that didn't exist the last time you brought your back-up disk up to date

The standard REPLACE command looks for Read-Write files in the target directory which match the file name template given in the command line. When it finds one which also has the same name as a file in the source directory, REPLACE replaces this file with the version from the source disk. The options allow you to:

- add any new files to the back-up disk
- replace Read-Only files as well as Read-Write files
- only replace a file if the source file is newer than the version on the target disk
- search subdirectories on the target disk for matching files
- confirm file-by-file that the old version is to be replaced

If an error occurs during the insert, REPLACE sets an exit code which can be used in an IF command (see Section 4.4).

Form REPLACE [*source-drive:*]\[\][path\]*filename.filetype target-drive:* [\][path][
option[option...]]

where *filename.filetype* is a template representing a number of files

- Options**
- /A** Add new files to the target directory (Cannot be used with either the **/D** or the **/S** option)
 - /D** Replace only if the source file is more recent (Cannot be used with the **/A** option)
 - /P** Prompt for confirmation before replacing a target file or adding a new source file
 - /R** Replace both Read-Write and Read-Only files
 - /S** Search both the given target directory and its subdirectories for old versions of the files (Cannot be used with the **/A** option)
 - /W** Wait until a key is pressed before starting replacing and adding files (ie. allows you to swap the disks in your floppy disk drives after issuing the instruction)

Exit codes	1	Command line error, eg. incompatible options
	2	No matching source or target files were found
	3	Either the source or the target path was not found
	5	Access denied ie. you tried to update a write-protected file
	8	Insufficient memory for REPLACE to operate
	15	You specified a drive that doesn't exist

Notes If you don't specify the */R* option, any attempt to replace Read-Only files will cause the insert process to stop.

If you don't specify the */W* option, the process of replacing and adding files will start immediately working with the disks currently in the drive(s).

You cannot use REPLACE to update the hidden system files. Use the SYS command to do this (see Chapter 6).

REPLACE can return standard MS-DOS error codes as well as the specific error codes listed above.

Examples

- To replace the existing back-up copies on Drive B of .TXT files on the default drive, use the command line:

REPLACE *.TXT B:

(assuming the external command REPLACE is stored either in the default directory or in a directory that is automatically searched by MS-DOS – see Section 4.2.4)

This will replace each old version with the new version, provided the old version allows Read-Write access. If you want to replace Read-Only files as well, you should use the command line:

REPLACE *.TXT B:/R

- If you want to have new versions of all the .TXT files on the default drive on the disk in Drive B – ie. including copies of any new .TXT files that you have created, you should use the command line:

REPLACE *.TXT B:/A[/R]

(Use the /R option if you want to replace any Read-Only files on the Drive B disk.)

If you want REPLACE to ask to about each file before it copies the new version to your back-up disk, you need to use the /P option – ie. a command line like:

REPLACE *.TXT B:/A/P

RMDIR

Internal command

RMDIR [d:][\]path

Remove a directory

RMDIR is used to delete a directory from the directory structure of a disk.

RMDIR can be abbreviated to RD.

Form RMDIR [d:][\]path
or RD [d:][\]path

Notes The subdirectory will not be deleted if it contains any files or if it has any references to directories other than the \. (current) and \.. (parent) directories.

The subdirectory will not be deleted if it is the current directory on any drive or if it is assigned to an imaginary drive (see Section 4.1).

Include the optional backslash if the path starts at a root directory; don't include it if the path starts at a current directory.

Examples

Suppose the pattern of directories on the disk in the default drive was like this:

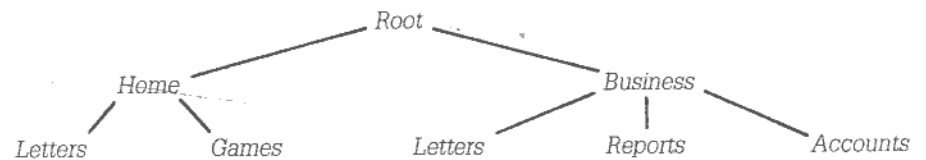

- To remove the Reports directory from this directory structure, use the command line:

RD \BUSINESS\REPORTS

or, if \BUSINESS is the current directory, use the command line:

RD REPORTS

Remember to clear the Reports directory of all files before using this command. Otherwise you will see the message:

Invalid directory

-
- To remove the 'Home' part of this directory structure, you need to clear and remove both the `\HOME\LETTERS` and the `\HOME\GAMES` directories and only then clear and remove the `\HOME` directory itself.

The first thing to do is to copy every file from all three directories you want to keep to another disk and/or another directory. When that has been completed, the command lines to use are:

```
CD \HOME
DEL GAMES\
DEL LETTERS\
RD GAMES
RD LETTERS
CD \
DEL HOME\
RD HOME
```

} - Clear and remove the Games and Letters directories
- Change to a different current directory (you can't delete the current directory)
- Clear and remove the Home directory

TREE ✓

External command

TREE [d:][/F]

Display the pattern of directories on a drive

The TREE command lists the full path to each directory on the disk together with the names of any subdirectories this directory has. This information enables you to plot out the directory 'tree' for the disk.

If the /F option is used, the names of the files in each directory are also listed.

- To display just the details of the directories

Form TREE [d:]

- To display filenames as well

Form TREE [d:]/F

Notes If you don't specify a drive, the command lists information about the disk in the default drive.

If the only directory on the disk is the Root directory, MS-DOS will display the message:

No subdirectories exist

Examples

- To display details of all the directories on the default drive, use the command line:

```
TREE
```

(assuming that the external command TREE is stored either in the default directory or in a directory on the search path - see Section 4.2.4)

The result could be something like this:

```
A>tree
  DIRECTORY PATH LISTING
```

```
Path:A:\SPREAD
```

```
Sub-directories: RECORDS
```

```
Path:A:\SPREAD\RECORDS
```

```
Sub-directories: None
```

If there is only a Root directory on the disk, TREE will display the message:

No subdirectories exist

- To display details of all the files as well as the directories on Drive C, use the command line:

TREE C:/F

The result could be something like this:

```
A>tree c:/f
DIRECTORY PATH LISTING
```

```
Path:C:\DIR1
```

```
Sub-directories: SUBDIR
```

```
Files      : MYFILE.1
             MYFILE.2
             MYFILE.3
```

```
Path:C:\DIR1\SUBDIR
```

```
Sub-directories: None
```

```
Files      : SUBFILE.1
             SUBFILE.2
```

TYPE

Internal command

TYPE [d:][\][path\]filename.filetype

List a simple text file

TYPE displays on your screen the contents of the named file. The only files suitable for being typed are simple ASCII text files.

If the file contains control characters, the display may be unreadable.

You can interrupt the listing by pressing Ctrl-S. Pressing Ctrl-Q restarts it. Pressing Ctrl-C abandons the listing.

You can only display one file at a time. Wildcards may not be used in the file specification.

Form TYPE [d:][\][path\]filename.filetype

Note Tab characters are replaced by spaces, putting the next character at the beginning of the next column. The columns are eight characters wide.

Examples

- To display the AUTOEXEC.BAT file in the default directory on the screen, use the command line:

```
TYPE AUTOEXEC.BAT
```

The result of this command could be something like this:

```
ECHO OFF
KEYBUK
MOUSE
\GEMSTART\DISPCHK
IF ERRORLEVEL 1 SET DISPLAY=ECD350
IF ERRORLEVEL 2 SET DISPLAY=CDCOLOR
IF ERRORLEVEL 3 SET DISPLAY=CDMONO
IF ERRORLEVEL 4 SET DISPLAY=MDHERC
IF ERRORLEVEL 5 SET DISPLAY=MDMONO
```

```
A>
```

- If the AUTOEXEC.BAT file you want to display is in the Root directory on Drive C, the command line you need is:

TYPE C:\AUTOEXEC.BAT

If you TYPE anything other than a simple text file on the screen, you will see lots of strange characters as TYPE tries to interpret special codes within the file as characters. For example, you might see something like this:

```
APPEN-                                     @External command$
@APPEN- @%[d%:%%]%%\%%path[%%:%%[d%:%%]%%\%%path...]%%
Set P %search% pat%$ fo% dat% files
```

Normally, if you don't say which directory a file is in, MS-DOS tries to effect what happens is that each pat% gives it a @thra APPEN- i%command%\$

This gives you a neat way of ensuring that the dat% files you need are

VOL

Internal command

VOL *d:*

Display disk volume label

VOL displays a DOS disk's label, ie. the name by which the disk can readily be identified and which you set by using the LABEL command (see Section 7.2).

Form VOL [*d:*]

Note The disk label is also displayed when you list any directory on the disk with a DIR command.

Example

To display the disk label on the default drive, use the command line:

VOL

To display the disk label of the disk in Drive B, use the command line:

VOL B:

XCOPY

External command

XCOPY [d:][\][path\]source [d:][\][path\]destination [option[option...]]

Copy files and directories

XCOPY is used:

- To make copies of individual source files
- To copy the directory structure as well

The source and the destination for each copy operation are directories on disk drives, and the directories that can be copied are ones that branch off the source directory. Empty directories can be copied as well as ones containing files or further directories.

XCOPY sets an exit code to report the success of the copy. This can be used in an IF command (see Section 4.4).

Form XCOPY [d:][\][path\]filename.filetype [d:][\][path\][destination-filename.filetype] [option[option...]]
where filename.filetype is a template using wildcards to specify a group of files.

Options /A	Only copy files that have the Archive attribute set (see Section 5.3). Note: the Archive attribute isn't reset after copying (see the /M option)
/D: dd-mm-yy	Only copy files that have been changed on or after the given date
/E	Copy empty subdirectories as well as ones with files in them. Note: The /S option must be selected as well.
/M	Only copy files that have the Archive attribute set (see Section 5.3). Note: the Archive attribute is reset after copying (see the /A option)
/P	Confirm each copy
/S	Copy files from both the given directory and from its subdirectories (retaining the subdirectory structure)
/V	Verify each copy as it is written, to check that the new file is identical to the original
/W	Wait until a key is pressed before starting the copy (allowing you to swap the disks after issuing the command line)

Exit codes 0	No errors
1	No files found to copy
2	Copy terminated by user (pressing Ctrl-C)
4	Either you specified an invalid directory, or there was an error in the command line syntax, or the file you specified wasn't found, or the path you quoted wasn't found
5	Copy terminated by user after a disk error

Notes You must include at least one of the source drive, directory or file name template, but you can leave out all details of the destination: the current directory on the default drive is assumed as the destination directory. *.* is the default file name template for both the source and the destination.

If you don't select the /S option, XCOPY will only copy files in the given directory. It will ignore any subdirectories to the directory and the files these contain.

If your chosen destination directory does not exist, XCOPY will create it for you. The directory must, of course, be a valid directory to create (see Section 5.1).

Examples

- To copy all the files from the \DIR1 directory (a subdirectory of the Root directory) on the default drive to the \DIR2 directory on Drive C, you might use the command line:

```
XCOPY \DIR1\*.* C:\DIR2\
```

(assuming that the external command XCOPY is stored either in the default directory or in a directory that MS-DOS automatically searches – see Section 4.2.4)

- To copy all the files and all the subdirectories with files in them from the \DIR1 directory on the default drive to the \DIR2 directory on a different disk, use the command line:

```
XCOPY \DIR1\*.* B:\DIR2\ /S
```

If you have a single-drive PC, MS-DOS will prompt you when to insert the disk for Drive A (your source disk) and when to insert the disk for Drive B (your destination disk). If you have a two-drive system, just use Drive B (the righthand disk drive) for the destination disk.

If you wanted to copy empty subdirectories as well as ones with files in them, your command line would become:

```
XCOPY \DIR1\*.* B:\DIR2\ /S /E
```

- If you have a single-drive PC and the external command XCOPY is on a different disk to the files you want to copy, use the /W option. This makes XCOPY wait until you press a key before starting the copy. So with the MS-DOS command disk in the drive, type the command line:

```
XCOPY \DIR1\*.* B:\DIR2\ /S /W
```

Then when the message:

Press any key when ready to start copying files

appears, release the MS-DOS disk from the drive and replace it with your source disk. Then press any character key (for example, the Space bar).

6. PROCESSING FLOPPY DISKS

Processing your floppy disks covers:

● Preparing new blank disks

- Dividing up the blank disk into sections so that your PC can store and retrieve information from the disk. This process is called Formatting the disk.

● Maintaining existing disks

- Making duplicate copies of your disks so that you have a reserve or 'back-up' copy for use in case of accidents.
- Testing your disks when you suspect that the reason for a program failing was a damaged disk.
- Comparing a copy you have made of a disk against the original.

These tasks are fundamental to using floppy disks in your PC. For example, the storage area of each new blank disk you buy must be formatted before you can use it, even if you just want to store one program or data file on it, and the process of copying a disk automatically includes formatting the disk used for the copy. Formatting is also used to reclaim a disk on which the data has become electronically damaged.

Formatting and copying disks are such important tasks that the steps you need to take have been included in Part I, Chapter 7 – the chapter of this manual that gives step-by-step instructions in using MS-DOS for the most common tasks on your PC. If such step-by-step instructions are what you are looking for, we suggest you turn to that chapter. Here, we describe some special features you can build into these processes.

6.1 Preparing new disks for use (Formatting)

> **FORMAT** > The process of marking out a new blank floppy disk uses the **FORMAT** command.

The simplest version of the command will give the new disk the number of tracks and sectors appropriate to the drive you use to format the disk in. For the standard drives supplied with your AMSTRAD PC, the appropriate format is 80 tracks (divided between the two sides of the disk) and 9 sectors per track.

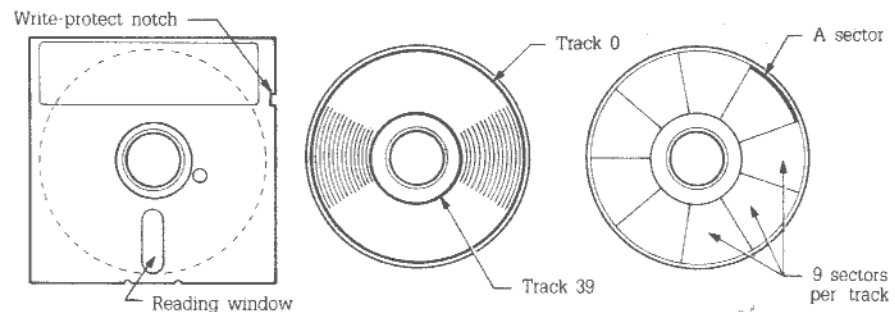

The command can also be used with an old disk on which the data has become corrupted. If the disk hasn't been physically damaged, formatting the disk can reclaim all its storage space. However, before you do this, do be sure to copy as many as possible of your files to other disks before you reformat the disk. Formatting a disk wipes it clean of any stored data.

The options associated with the FORMAT command let you:

- **both format and prepare the disk for use as a startup disk, ie. as a disk that you can insert immediately after you switch your PC on**
- **format the disk so that it could later be made a startup disk without losing any of the data and programs then stored on the disk**
- **give the disk a disk label**
- **just format one side of the disk, even though the drive is two sided**
- **have 8 sectors per track rather than 9**
- **to have some other specific number of tracks and/or number of sectors**

The beginning of this list gives the options you are most likely to need: the other options are a little obscure. For example, giving a disk a label gives it a name that will be shown on the screen every time you use the DIR command to display details of files on the disk. But the only reason to format only one side of a disk is if you will want to store data on it that you will also want to use in an older microcomputer that only has single-sided disk drives. Similarly, you would only opt for different numbers of tracks and sectors on the disk if this was required on another microcomputer that you were proposing to use the disk in. The earliest IBM PCs, for instance, required 8 sectors per track.

When you specify that you want the disk to be used either now or later as a startup disk -- ie. as a disk that you can use immediately after switching your PC on, FORMAT allocates some of the disk space to the system files needed to run MS-DOS and, to prepare the disk fully, copies the files COMMAND.COM, IO.SYS and MSDOS.SYS onto the new disk. The two .SYS files never appear when you list the directory of a startup disk so that you don't accidentally delete them.

- > **SYS** > If you decide to postpone making your disk a Startup disk, you can copy IO.SYS and MSDOS.SYS to the disk later by using the SYS command.

The space allocated to the system files on a Startup or a Potential Startup disk cannot be used to store data files and program files, and so the amount of space available for your files is reduced by about a sixth. It would therefore be wasteful to make all your disks potential Startup disks. Instead, only choose this option if you are fairly sure that you are going to need to make the disk a Startup disk.

6.2 Copying disks

- > **DISKCOPY** > The process of copying a disk onto another makes the second disk a 'photocopy' of the first. Immediately after the copy has been made, the two disks are identical in every way; however, any processing you do of either disk will stop them from being identical.

The command used is DISKCOPY.

The only information that DISKCOPY needs is which drive will hold the disk you want to make a copy of (the Source drive) and which drive will hold the disk the copy will be made on (the Target drive). The target drive doesn't have to be a different drive from the source drive, but if you have two drives this is usually the most convenient way of working. If you use the same drive for both source and target, DISKCOPY will prompt you at the point in the process at which you need to change the disk in the drive from the source disk to the target disk.

Note: If you want to put the copy on a new blank disk, you don't have to format the new disk before you start to make your copy. DISKCOPY will give the new disk the same format as the source disk.

6.3 Checking disks

- > **CHKDSK** > When a program fails unexpectedly, with MS-DOS reporting an error in reading or writing a disk, it may be that your disk has become physically damaged (for example, scratched) but it may be that your program or its data has become corrupted electronically.

The command to use to check a disk for errors is CHKDSK. This will check a disk for

- errors in the directory structure that would prevent you from accessing certain parts of the directory tree
- errors in the recorded list of the areas of the disk used to store a file
- bad directories

Any errors it finds are reported through error messages.

Errors such as these will stop your program from working. CHKDSK can in some cases ease the problem by 'correcting' the error - though perhaps with the loss of some data from a file. However, it will only do this if you specifically select one of the CHKDSK options: its normal action is just to produce a status report on the disk - plus, if you want, a report on a specific file on that disk. The report on a file will tell you, in particular, how many separate ('non-contiguous') areas of the disk are used to store the file. (Re-using areas of the disk freed by deleting a file usually leads to the new files being stored in a number of separate areas of the disk.)

6.4 Comparing disks

- > **DISKCOMP** > You may occasionally want to compare your security copy of a working disk (created by copying the disk using DISKCOPY) with the original disk. For example, you may keep two security copies of a working disk which you copy the disk to alternately and so you may at some time become confused as to which is the up-to-date copy.

The command to use is DISKCOMP. This carries out a track-by-track comparison of the two disks and, when DISKCOMP finds a difference between the disks, it puts up a message specifying on which side of the disk and in which track it found the discrepancy. Either one side or both sides of the disks can be compared in this way. Full details are given in the reference part of this chapter.

Note: The DISKCOMP command will only make a valid comparison if the copy was made using DISKCOPY. If you made the back-up disk by COPYing each file individually, the comparison will probably fail because although the data is the same and the directory tree is the same, the files themselves are likely to be in different places on the disk.

CHKDSK ✓

External command

CHKDSK *d: [\][path\][filename.filetype][/F][/V]*

Check disk for errors and file for non-contiguous storage areas

CHKDSK produces a status report on a disk and optionally on one of the files on the disk as well. This report summarises how the storage space on the disk is divided between directories, files, hidden files and free space and how parts of the specified file are allocated to different non-contiguous storage areas on the disk. (Re-using areas of the disk freed by deleting a file usually leads to the new files being stored in a number of separate areas of the disk.)

If CHKDSK encounters any places on the disk where files or directories have been corrupted, it will display appropriate error messages on the screen. Normally all these messages are displayed at the end of the process, but if you choose the /V option, these messages will be displayed as the errors are found.

CHKDSK's main role is to report errors but there are some problems that it can overcome (possibly with some loss of data) as it processes the disk. These are:

- errors that cause parts of the directory tree to become inaccessible
- errors in the table that holds details of where the separate parts of a file are stored (the File Allocation Table)

If you choose the /F option, places where the directory tree has become inaccessible will be removed from the directory tree and files will be cut short at the point the error appears in the File Allocation Table. However, sections of files that become detached from the main file are recovered and stored in files called **FILEnnnn.CHK**. If these broken files are text files (or word processor files), you can then use a text editor or a word processor to recover most of your data.

- To report on a disk

Form CHKDSK *[d:][/F][/V]*

- To report on a file

Form CHKDSK *[d:][\][path\][filename.filetype][/F][/V]*

Options /F Fix errors as the disk is processed
/V Display messages as the disk is processed

Note You can send the output from CHKDSK to a file rather than display it on the screen, but then you cannot use the /F option.

Examples

- To check the disk in the default drive for errors, use the command line:

```
CHKDSK
```

(assuming that the external command CHKDSK is either in the default directory or in a directory that MS-DOS automatically searches – see Section 4.2.4)

If you want to check the disk in Drive B, the command line to use will be:

```
CHKDSK B:
```

Either of these commands will produce a report something like this:

```
A>chkdsk
```

```
362496 bytes total disk space
 5124 bytes in 5 directories
124928 bytes in 20 user files
234444 bytes available on disk
```

```
655360 bytes total memory
595612 bytes free
```

No attempt will be made to correct for any errors that CHKDSK finds.

- To tell MS-DOS to check the disk in Drive B and correct as far as possible for the errors that are detected, use the command line:

```
CHKDSK B:/F
```

Parts of the directory tree that have become inaccessible will be removed from the tree and files that have been damaged will be cut short, with the removed sections recovered and stored in files called FILEnnnn.CHK. You may then be able to use a text editor or a word processor to re-unite these with the main part of the file.

- To discover how many separate storage areas of the default disk are used to store a file called MYFILE.TXT in the \DIR1 directory, use the command line:

```
CHKDSK \DIR1\MYFILE.TXT
```

The result you see on the screen could be something like this:

```
A>chkdsk \dir1\myfile.txt
```

```
362496 bytes total disk space
 5124 bytes in 5 directories
124928 bytes in 20 user files
234444 bytes available on disk
```

```
655360 bytes total memory
595612 bytes free
```

```
A:\DIR1\MYFILE.TXT
```

```
Contains 2 non-contiguous blocks
```

DISKCOMP

External command

DISKCOMP *source-drive:* *target-drive:* [/1] [/8]

Compare contents of target drive against contents of source drive

Note that **DISKCOMP** and **DISKCOPY** apply only to floppy disks. You must use **COPY**, **XCOPY**, **BACKUP** and **RESTORE** to make copies between Hard Disks and floppy disks.

The **DISKCOMP** command is used to make a track-by-track comparison between two disks. These disks can either be in different drives or in the same drive. **DISKCOMP** first checks that the disks have the same format and then checks each track on the target disk against the corresponding track of the source disk. Where it finds a difference, it displays a **Compare error** message giving the track number and the side where the difference was found.

DISKCOMP normally compares both sides of the disks and all nine sectors on each track, but you can limit the comparison to just one side of the disks or to just the first eight sectors on each track by selecting the appropriate options. It compares a section of the disks at a time, reading first the source disk and then checking the target disk against this.

After the comparison has been completed, **DISKCOMP** asks you if you want to compare another pair of disks. Type **Y** to compare another; type **N** to leave **DISKCOMP**.

Form DISKCOMP *source-drive:* [*target-drive:*] [/1] [/8]

Options /1 Compare just the first side of the disks
/8 Compare just the first eight sectors of each track

Notes If you don't specify a target drive, this is taken to be the default drive.

If the target drive is the same as the source drive, **DISKCOMP** will prompt you when to insert the source disk and when to insert the target disk as it compares the disks section by section.

You cannot use **DISKCOMP** on a drive that has been **ASSIGNed**, **JOINed** or **SUBSTituted** (see Section 4.1).

Examples

- To compare the disk in Drive A with the disk in Drive B, use the command line:

DISKCOMP A: B:

(assuming that the external command **DISKCOMP** is stored either in the default directory or in a directory that MS-DOS searches automatically - see Section 4.2.4)

This is the command line to use if Drive A or Drive C is the default drive, but if Drive B is the default drive, your command line can be:

DISKCOMP A:

The result of this comparison could be something like this:

```
A)diskcomp a: b:  
Insert FIRST diskette in drive A:  
Insert SECOND diskette in drive B:  
Press any key when ready . . .
```

```
Comparing 40 tracks  
9 sectors per track, 2 side(s)
```

Compare OK

Compare error on side 0, track 0

Compare another diskette (Y/N)?

Compare another diskette (Y/N)?

- If you just want to compare one side of each disk, use the command line:

```
DISKCOMP A: B:/1
```

DISKCOPY

External command

DISKCOPY *source-drive:* *target-drive:*

Copy contents of source drive to target drive

Note that **DISKCOMP** and **DISKCOPY** apply only to floppy disks. You must use **COPY**, **XCOPY**, **BACKUP** and **RESTORE** to make copies between Hard Disks and floppy disks.

DISKCOPY is used to produce a track-by-track copy of one disk on another. If the target disk is unformatted, it will format it identically to the source disk as part of making the copy.

The target drive does not have to be a different drive from the source drive. If these drives are the same, then **DISKCOPY** will read the source disk and then prompt you to change the disk in the drive to the target disk.

When the copy has been completed, **DISKCOPY** asks you whether you want to copy another disk. Type **Y** to copy another; type **N** to leave **DISKCOPY**.

Form **DISKCOPY** [*source-drive:*] [*target-drive:*]

Notes If you only specify one drive, then the target drive is taken to be the default drive. If you don't specify any drives, **DISKCOPY** performs a single-drive copy that uses the default drive as both the source drive and the target drive.

If you want to use the default drive as the source drive but another drive as the target drive, you have to give the drive letters of both drives.

The target disk will be formatted before the copy is made if it hasn't been formatted already or if it doesn't have the same format as the source disk.

Example

To make a copy of the disk in Drive A, use the command line:

DISKCOPY A: B:

(assuming that the external command **DISKCOPY** is stored either in the default directory or in a directory that MS-DOS automatically searches – see Section 4.2.4)

This is the command line to use if Drive A or Drive C is the default drive. If Drive B is the default drive, you can use the command line:

DISKCOPY A:

If you have a single-drive PC, you will be prompted when to insert the disk for Drive A (the disk you want to copy) and when to insert the disk for Drive B (the target disk, ie. the disk you want to store the copy on). If you have a two-drive system, put the target disk in Drive B (the righthand disk drive).

If the target disk hasn't been formatted or has a different format to the source disk, you will see the following message on the screen:

Formatting while copying

FORMAT

External command

FORMAT *d:*[*option*[*option*...]]

Format the disk in the specified drive

The FORMAT command is used to:

- prepare a new blank disk for storing data and programs
- reclaim an old disk on which the data has been corrupted

The simplest form of the command formats the disk according to the characteristics of the drive holding the disk. Thus a disk held in a standard floppy disk drive on the AMSTRAD PC will be formatted to have 80 tracks (divided between its two sides) and to have 9 sectors per track.

A floppy disk can be formatted:

- to be used as a Startup disk (ie. it can be used immediately after the PC is switched on)
- to have special numbers of tracks and sectors
- only on one side of the disk

depending on which options are selected. As it finishes formatting one disk, FORMAT asks whether you want to format another. Type Y ↵ to format another in the same way; type N ↵ to leave FORMAT.

Exit codes are set at the end of the format to record whether the format operation was successful. These can be used in a IF command (see Section 4.4).

You have to specify which drive will hold the disk to be formatted. This is to safeguard you against accidentally formatting your default drive. Even so, it is a good idea to cover the write-protect notch on the disk holding the FORMAT program: even the most careful user can make typing mistakes!

Note that the **FORMAT** command can be used to format Drive C: - indeed this was performed as part of the Hard Disk installation process. Because formatting Drive C: is potentially a very serious business, the **FORMAT** program issues two warnings before carrying out this process. The first warning (only if some data is detected on the Hard Disk) is:

Enter current Volume Label for Drive C:

You must then type exactly the Volume Label, followed by ↵, otherwise the **FORMAT** program will abort. The Volume Label is displayed every time a **DIR** command is performed and can be changed by the **LABEL** command. It is strongly recommended that you label your Drive C: with, for example, your name in order to identify directory printouts as well as preventing possible accidents with **FORMAT**. If the Drive has no label, then simply a ↵ is required by **FORMAT**.

The second warning is:

**WARNING, ALL DATA ON NON-REMOVABLE DISK
DRIVE C: WILL BE LOST!
Proceed with Format (Y/N)?**

Only enter Y if you are sure that you want to proceed.

In order to create new MS-DOS Startup disks, you should insert Disk 1 (Microsoft MS-DOS) and use the command:

FORMAT B: /S

Then follow the instructions on the screen for inserting the disk for Drive A and the disk for Drive B.

Form **FORMAT** *d:[option[option...]]*

Options

- /1** Format as a single-sided disk
- /8** Format with 8 usable sectors per track
- /B** Reserve space for hidden system files
- /N:n** Format with *n* sectors per track (*n*=8, 9)
- /T:t** Format with *t* tracks (*t*=40, 80)
- /V** Prompt for a disk label after the format has been completed (the label – which is shown on the screen every time you use the DIR command to display the contents of the disk – can be up to 11 characters long)
- /S** Format and prepare for use as a Startup disk by copying the system files from the default drive to the newly formatted disk

Exit codes

- 0** Format successful
- 3** Terminated by user
- 4** Fatal error
- 5** Hard (Winchester) disk format abandoned

Notes If you have the FORMAT external command stored on a floppy disk, write-protect this disk by covering the write-protect notch with the small sticky label before you type in a FORMAT command.

If you use the /S option, this must be the last option specified in your command line. You should also note that the hidden files IO.SYS and MSDOS.SYS and the COMMAND.COM file are copied to the disk.

If you use the /S option with no MS-DOS Startup disk in the default drive, FORMAT will prompt you to insert a 'System' disk before copying the system files to the new disk. Insert a copy of AMSTRAD PC Disk 1.

You should not use the FORMAT command with any ASSIGNed, JOINed or SUBSTITuted drives (see Section 4.1).

If you use the /B option, you can put any version of MS-DOS onto the disk. You are not restricted to MS-DOS Version 3.2.

Examples

- To format a floppy disk for use simply to store programs and data, put the disk holding the FORMAT command in Drive A, make Drive A the default drive (if it isn't already) and use the command line:

FORMAT B:

If you have a single-drive PC, you will be prompted when you need to insert the disk

for Drive B (the floppy disk you want to format). If you have a two-drive system, insert this disk in Drive B (the righthand disk drive).

- To format a floppy disk for use as a Startup disk, ie. to use to load the MS-DOS operating system from immediately after switching on or resetting your PC, put a copy of the AMSTRAD PC Disk 1 (MS-DOS Startup and Utilities) in Drive A, make Drive A the default drive (if it isn't already) and use the command line:

FORMAT B:/S

If you have a single-drive PC, you will be prompted when you need to insert the disk for Drive B (the floppy disk you want to format). If you have a two-drive system, insert this disk in Drive B (the righthand disk drive).

The final stage of the process will copy the IO.SYS, MSDOS.SYS and COMMAND.COM files from the Startup and Utilities disk onto your new disk.

SYS

External command

SYS d:

Copy system files to the disk in the specified drive

The SYS command copies the system files on the disk in the default drive to the disk in a specified drive. It is therefore used:

- to update the version of MS-DOS used on a particular startup disk
- to put the system files on a disk that has been formatted to allow room for these files (see the **FORMAT** command)

The files copied are IO.SYS and MSDOS.SYS. COMMAND.COM is not transferred. Use a COPY command to add this file if you want to use the MS-DOS commands.

Form SYS d:

Notes If you want to update your system files but the new IO.SYS and MSDOS.SYS files take up more room than the old ones (eg. Version 3.2 files take up more room than Version 2.0 files that have been prepared on another compatible computer), you will have to re-format the disk. **Remember to copy all the data and program files from this disk to other disks before re-formatting the disk.**

IO.SYS and MSDOS.SYS are both hidden files and so are not listed when the directory of a Startup disk is listed.

Example

To copy the IO.SYS and MSDOS.SYS files onto the disk in Drive B, use the command line:

SYS B:

(assuming that the external command SYS is either in the default directory or in a directory that is automatically searched by MS-DOS - see Section 4.2.4)

7. TAILORING YOUR PC TO YOUR NEEDS

When you bought your AMSTRAD PC, it was set up to be used in a very conventional way – with the keyboard your main means of giving instructions and information (ie. input) to the computer and the display screen used by the computer to display (ie. output) information. The system prompt and the number of lines and characters in each page of information are among other details set up conventionally.

This chapter describes how to set up your PC to work in precisely the way you want.

You might, for example, want to set up your PC so that it can send the data it normally sends to the printer down a communications link to another computer. Or you might want to change the number of lines and columns on your screen so that you can run a program that was designed to run on, for example, a 40-column screen.

Other possibilities are to add extra information to your system prompt such as the current directory or the time and giving your disks names that help you remember what information they hold.

This chapter explains how to tailor your PC to your needs by:

- **Setting up Input and Output Devices**

Bring a printer or a communications link into play or change the details of how your current set of Input and Output Devices work by:

- setting device parameters
- organising what information is sent where

- **Personalising your PC**

- by setting up a personalised system prompt
- by giving disks labels

- **Setting your PC's clock**

- setting the date
- setting the time

7.1 Setting up your PC's Input and Output Devices

When you buy an AMSTRAD PC, it is set up:

- to receive most instructions and information from the keyboard
- to send program output to the monitor (unless told otherwise)
- to send printer output to the Parallel Printer port on the back of your machine
- to send and receive any auxiliary information via the Serial Interface on the back of your AMSTRAD PC

This is a perfectly satisfactory arrangement, but there are two possible ways in which you might want to change it:

1 You might want to change the roles of some of the Input and Output Devices.

You might, for example, want to make the Serial Interface the main information channel because you have linked your PC to another computer through this connector. Or you might need to send printer output to the Serial Interface because your printer has a serial interface to it, rather than a parallel one.

2 You might want to replace an Input or an Output Device or you might want to change how the current device is set up.

For example, you might want to replace your printer or your communications link with a new one that needs data sent to it at a different speed or checks the data has been sent correctly in a different way – or you might just want to change the speed at which data is sent to your current link.

The commands that set up the special needs of your system should be put into the AUTOEXEC.BAT file on the disk you use as your Startup disk, because you will need these commands every time you use your PC.

Changing the roles of particular devices

Your programs appear to be designed to take some information through the keyboard and other information from, say, the Serial Interface and to send some messages to the screen and some, say, to the printer. Changing where information comes from and goes to would seem impossible without rewriting the program.

In fact such changes are made very easily because, in general, your programs don't make use of your Input and Output Devices directly. Instead, they use 'logical' devices which MS-DOS links to 'physical' devices such as your keyboard and your monitor. If your program does use the Input and Output Devices directly, it would indeed have to be rewritten before information could be taken from or sent to other places.

Section 4.3 covered how to change where the 'keyboard' input comes from and where the 'monitor' output goes to, command by command. This section describes how to make those changes more permanent.

To change which device acts as the keyboard

> **CTTY** > Normally, all command lines are typed in at your PC's keyboard. However, if you link your AMSTRAD PC to another computer or if you attach a terminal to your computer, you might well want to give your PC instructions from the other computer or from the terminal.

You probably will have connected the computer or the terminal to your PC via the Serial Interface on the back of your AMSTRAD PC. So you need to tell MS-DOS to take instructions from the Serial Interface, not from the keyboard. This is done with a CTTY command. All this command needs to know is the MS-DOS device name for the Serial Interface. MS-DOS has two different device names for the Serial Interface – COM1 and AUX, either of which can be used in the CTTY command.

The command has an immediate effect. Once you have entered your CTTY command and it has been accepted, the next command line must come from the new input device.

When you want to return to using the keyboard again, you simply use another CTTY command – this time giving it the device name CON, which is the name MS-DOS has for both the keyboard and the monitor. However, this command will have to be entered at your current 'keyboard'. If you get into difficulties, you always have a way out in either resetting your PC by holding down **Ctrl** and **Alt** and pressing **Del** (using your PC's keyboard) or switching off and switching on again. Either of these actions will, however, lose any unstored data in your PC.

Sending printer output to the Serial Interface

> **MODE** > Printer output from your programs is normally sent to the Parallel Printer port on the back of your AMSTRAD PC. The chances are that you have a printer with a parallel interface to it.

However, if your printer has a serial interface to it, you will need to attach this to a serial port, for example the Serial Interface on the back of your machine. You will also want MS-DOS to direct printer output to this port if you want to send this output to another computer.

The command to use is MODE. One of this command's jobs is to tell MS-DOS to send all information directed to a particular printer device (known to MS-DOS as LPT1, LPT2 or LPT3) to a serial device (known to MS-DOS as COM1 or COM2). The command takes effect immediately. LPT1 is set by default to the device attached to the Parallel Printer connector on the back of your AMSTRAD PC. COM1 is set by default to the device attached to the Serial Interface on the back of your machine. (In this instance you can't use the device names PRN and AUX often used for devices attached to these two connectors.)

When you want to send this output to a parallel printer again, just use another MODE command – this time leaving out the serial device name but including any device settings your parallel printer requires, even if you had set these up before. Otherwise the default settings will be used.

New equipment or settings

> **MODE** > Your PC must be set up to communicate with each of its input and output devices. MS-DOS initially holds the details your PC needs to communicate with the devices it is supplied with but these details have to be changed when:

- **you install a new peripheral**

For example, you might install a new printer or a new communications link.

- **you change the setting on an existing peripheral**

For example, you might change the speed at which data is transmitted along a communications link.

- **you run a program that has been set up for a different screen**

Note: Remember if you want to use your printer to print graphics screen displays to use the GRAPHICS or MDGRAPH command as well (see Section 4.2).

To set up a parallel printer

The aspects of a parallel printer you may have to set are the maximum number of characters that can be printed on a line and the spacing between the lines. In addition, because your PC will send data to the printer faster than the printer can handle it, you may also want to tell MS-DOS to keep trying to send output to the printer.

MS-DOS has built into it some default settings which may well suit your printer. These are 80 characters per line and 6 lines per inch. The command to use to change either of these settings and to tell MS-DOS to keep trying to send output is the MODE command.

Just one MODE command is used to set all of these values. Any aspect you don't specifically set in the command will be set to the default value.

To set up a communications link

The aspects of a communications link you may have to set are:

- **the rate at which data is transmitted on the link (the baud rate)**
- **the checking that is applied to the data (the data's parity)**
- **the number of data bits to each character**
- **the number of stop bits to each character**

You may also need to set these parameters if you attach a serial printer, rather than a communications link to your Serial Interface – along with a special setting that tells MS-DOS that you are using the link in this way.

The values you need to set should be specified in the literature supplied with the communications link. If you can't find this information in the brochures, consult your dealer. (Full details of communications links and what these parameters describe are outside the scope of this manual.)

MS-DOS has built into it some default settings for the Serial Interface on the back of your PC which may well suit your communications link. These are Even parity and 7 data bits. In addition, setting 110 baud automatically sets 2 stop bits but any other transmission rate sets 1 stop bit.

The command to use to change any of these settings and to tell MS-DOS that you are using the interface for a printer is the MODE command. Just one MODE command is used to set all of these values. You have to set the baud rate but any other aspect you don't specifically set in the command will be set to the default value.

Adjusting the screen display

The AMSTRAD PC normally has an 80-column display and either a colour or a monochrome screen. However, the programs you buy will have been set up for:

- **either a colour or a black-and-white display**
- **either a 40-column or an 80-column screen**

These programs will run perfectly well, but if they have not been set up for an 80-column colour screen, they may not give quite the screen output you expected. To correct this, you will need to set your PC's screen to match that expected by your program. The command to use for this is again the MODE command.

Unlike the case with some other PCs, changing screen mode in this way won't affect the screen alignment and so no adjustment will need to be made.

7.2 Personalising your PC

Personalising your PC is about changing some aspects of the way your computer works so that, instead of being as provided by AMSTRAD, they are set up to suit you.

Personalising the system prompt

> **PROMPT** > Your personal MS-DOS system prompt doesn't have to be the current default drive. It can contain any of the following:

- **the default drive**
- **the default directory**
- **the date**
- **the time**
- **the version number of your MS-DOS**
- **special text or characters**

- whatever information you will find most helpful while you are using MS-DOS.

The command that sets up a personalised prompt is the PROMPT command.

Your new style of prompt will be used until your PC is reset. Then MS-DOS will revert to the standard A> prompt. If you want to always use a special style of prompt, simply put the PROMPT command to set it up into your AUTOEXEC.BAT file (see Section 4.4).

Giving disks labels

> **LABEL** > When you have a number of files and directories on a disk, it is not always easy to tell which disk you are working with, particularly if it could be any one of a number that you haven't used for some time.

The way to make finding out which disk you have in the drive much simpler is to give each of your disks a disk label - that is, an individual name of up to 11 characters. This name is always displayed when you use the DIR command to list any directory on the disk, even ones way down the directory tree - giving you a very easy way to tell which disk it is. The disk label also gives you a useful title by which you can catalogue your disks and the files they hold.

Use the LABEL command to give a disk such a label (or to change the label if it already has one).

7.3 Setting your PC's clock

- > **DATE** > The AMSTRAD PC's internal clock is maintained in the battery-backed area of the computer's RAM so that it keeps perfect time even when your PC is switched off.
- > **TIME** > However, it will be reset to 1 January 1980 if the batteries start to go flat. You can avoid this ever happening by changing the batteries regularly – say, once a year – but if the batteries do go flat, you should first renew the batteries (See Appendix II) and then reset the clock.

You can reset the clock either from the GEM Desktop – as described in Part II (Section 6.1) – or through the MS-DOS commands, DATE and TIME described in the reference part of this chapter.

CTTY

Internal command

CTTY *device*

Change the device used to issue commands

Normally, all command lines are typed in at the keyboard. The CTTY command tells MS-DOS to in future expect all command lines to come from a different input device – for example, the PC's auxiliary input device – if, for example, you want to type in command lines from a terminal attached to the Serial Interface.

- **To use an auxiliary device to issue commands**

Form CTTY AUX

- **To again use the keyboard for issue commands**

Form CTTY CON

Notes The changeover to using the other device happens immediately.

The command to go back to using the keyboard to issue commands has to be entered from the auxiliary device currently being used for all commands. If you get into difficulties in returning to normal operation, you can always reset your PC by holding down **Ctrl** and **Alt** and pressing **Del** on your PC's keyboard.

Some programs take their input directly from your PC's hardware. The CTTY command has no effect when this is the case.

DATE

Internal command

DATE [dd-mm-yy]

Set or read the date

DATE is used either to display or set the current date. This date is maintained in battery-backed RAM in your PC and it is automatically updated every time the PC's clock gets to 00:00 (ie. midnight). However, if the battery power falls, the clock will be reset to 1 January 1980: if this happens, renew the battery (see Appendix II) and then set the date.

Any date you type in is checked before it is accepted. If the date is invalid, you will be asked to type in a new date.

Form DATE

or DATE dd-mm-yy

where *dd* represents the day (01...31), *mm* the month (01...12) and *yy* the last two digits of the year (00...99).

Note If you type **DATE**, the current setting is displayed and then you are asked to type in a new date. If the date is correct, just press

Example

To set the date to be 1st November 1986, either use the command line:

```
DATE 01-11-86
```

which does the whole job in one go, or just:

```
DATE
```

If you use the second command, you will see something like this on the screen:

```
A>date
Current date is Sat 12-11-1986
Enter new date (dd-mm-yy):
```

Type:

```
01-11-86 
```

to set the date.

FDISK

External command

FDISK

WARNING: The FDISK program is very powerful, and can completely erase all the information on your Hard Disk. Only use it if there is nothing on your Hard Disk that you wish to keep. If you are in any doubt, contact your dealer.

Your Hard Disk is divided into separate areas, called partitions. It is possible that you also wish to install another completely 'foreign' or 'non-DOS' operating system. This would require use of the FDISK command to create a 'non-DOS' partition for that operating system. Normally the whole of your Hard Disk will be assigned as a DOS partition.

FDISK is different from many of the other MS-DOS commands because it is menu-driven. Reset your machine with Disk 1 (Microsoft MS-DOS) in the floppy disk drive, and when the A> appears, type:

FDISK

The main menu is displayed:

Fixed Disk Setup Program Version 0.01
(C) Copyright Microsoft, 1985

FDISK Options

Choose one of the following:

- 1 Create DOS Partition
- 2 Change Active Partition
- 3 Delete DOS Partition
- 4 Display Partition Data

Enter choice:

Press ESC to return to DOS

You will see that each option has a number associated with it, and there is a box containing a number labelled:

Enter choice:

This box contains the current choice. Initially it contains the number 1. This is the option that the computer thinks you are most likely to require, and is called the default. If you press a number, you will see it appear in the box. When you have the option you want, press

Each option is described in detail in the sections that follow.

Create DOS partition

This creates a partition on your Hard Disk which is suitable to be shared between MS-DOS and any other Operating System that you install. If you select this and your Hard Disk already has a DOS partition, then FDISK will tell you:

Create DOS Partition

Partition	Status	Type	Start	End	Size
1	A	DOS	0	610	611

Total disk space is 611 cylinders
Fixed disk already has a DOS partition
Press ESC to return to FDISK Options

Press **Esc** to take you back to the main menu. No other key will have any effect.
If your Hard Disk does not already have a DOS partition on it, you will have to choose whether to use the entire disk for DOS, or just allocate a part of it. In general, the entire disk is used for DOS. FDISK will ask you:

Do you want to use the entire fixed disk
for DOS (Y/N).....?

The normal reply is Y (for yes) so if you want to use all of the disk for DOS, then just press **Y** otherwise reply **N** followed by **Enter**

If you pressed just **Enter** the screen will clear and there may be a message visible for a second or so. In any case, the message:

System will now restart
Insert DOS diskette in drive A:
Press any key when ready ...

will appear. Press any key, and the machine will reset and start up again. Make sure that your Disk 1 is still in the disk drive. Your Hard Disk is now ready for FORMATTing. Details of how to do this are given in Part 1 Chapter 3.

If you didn't want to dedicate your entire Hard Disk to DOS, you'll be asked how much space to allocate to DOS. This question will take the form (for example):

Total fixed disk space is 305 cylinders
Maximum available space is 305
cylinders at 0
Enter partition size.....:

As you type in the size of the partition you want, it will appear in the box. The number you choose can't be bigger than the maximum available space number, but it can be equal to it.

FDISK will then ask you for the starting cylinder number. Again, it will choose a sensible figure as the default if you don't give it a specific number.

Once the starting cylinder has been selected, FDISK will set up the partition, and continue in the same way as if it had just created a partition the size of the entire disk (see above).

Change active partition

This causes FDISK to display information about all the partitions on your Hard Disk. It shows you the size, position, type and whether active or not, for each partition. There is only one active partition on a Hard Disk, and that's the one that the computer uses when it's first turned on. All the other partitions are inactive. If you only have one partition, then it has to be active.

If you had more than one partition (fairly unlikely!) the information would be displayed on the screen something like this:

Change Active Partition

Current Fixed Disk Drive : 1

Partition	Status	Type	Start	End	Size
1	A	DOS	0	130	131
2	N	non-DOS	131	304	171

Total disk space is 305 cylinders

Enter the number of the partition you want to make active.....:

Press ESC to return to FDISK options

Type the number of the partition you want to make active, and press . The computer will choose the currently active partition as the default, to reduce the risk of accidents.

If, as is likely, you have just one partition covering the entire Hard Disk, then FDISK will inform you that:

Partition 1 is already active

Press ESC to return to FDISK options

In that case, you have to press to return to the main menu. No other key will have any effect.

Delete DOS partition

FDISK displays a screen showing information on each partition on your Hard Disk, and asks you whether or not you want to delete the DOS partition.

WARNING If you answer Y to that question, the partition and all the data that it contained will be lost for good. For that reason, FDISK selects N as the default.

The screen will look something like this:

Delete DOS Partition

Partition	Status	Type	Start	End	Size
1	A	DOS	0	610	611

Total disk space is 611 cylinders

Warning! Data in the DOS partition will be lost. Do you wish to continue.....?

Press ESC to return to FDISK options

If you don't want to delete your DOS partition, press either or to return to the main menu. Otherwise type Y and press . The partition will be deleted, and you will be returned to the main menu.

Display partition data

Choosing the fourth option will display a screen showing information about all the partitions on the disk. It will look something like this:

Display Partition Information

Partition	Status	Type	Start	End	Size
1	A	DOS	0	610	611

Total disk space is 611 cylinders

Press ESC to return to FDISK Options

Press to return you to the main menu.

LABEL

External command

LABEL [d:] label

Create or change a disk label

The LABEL command is used to give your disks unique labels which you can thereafter quickly check when you want to find out which disk you have in a drive. The label is always displayed when you use a DIR command, even when you are looking at a directory way down the directory tree. Disk labels can also help in cataloguing your disks.

The label can be up to 11 characters long, including spaces.

If you don't type in a new label, MS-DOS displays the existing label (if any) and asks you what new label you want to give the disk. Just press the key either to keep the existing label or to delete the label. (You will be asked which of these options you require.)

Form LABEL [d:] [label]

Notes You can use any characters in the disk label except: * ? / \ | . , ; : + = < > []

Spaces are allowed. If you try to use any of these characters, your new label won't be accepted and you will see an error message.

You can't label a disk if the drive it is in has been ASSIGNED to another drive or JOINed to a directory.

Example

To give the disk in Drive B the label RECORDS 86-7, either use the command line:

```
LABEL B: RECORDS 86-7
```

which does the whole job, or just:

```
LABEL B:
```

Then you will see something like this on the screen:

```
A>label b:
```

```
Volume in drive B label RECORDS  
Volume label (11 characters, ENTER for none)?
```

To set the new label, type:

```
RECORDS 86-7 
```

(Both these commands assume that the external command LABEL is stored either in the default directory or in a directory on the search path - see Section 4.2.4.)

MODE

External command

MODE *device*:*setting*[,*setting*...]

Set mode of operation of Input and Output Devices

The MODE command is used:

- to set the number of characters per line and lines per inch on a line printer
- to set the transmission rate, parity etc. of communications links
- to adjust the screen display
- to redirect printer output to the serial interface

Notes The device name to use for the Parallel Printer on the AMSTRAD PC is LPT1. Do not use the alternative name PRN in a MODE command.

The device name to use for the Serial Interface on the AMSTRAD PC is COM1. Do not use the alternative name AUX in a MODE command.

Error messages will be displayed if you try to set device parameters to invalid settings or you try to direct printer output to a communications device that doesn't exist.

- To set up a parallel printer

Form MODE *device*: [*characters-per-line*][,*lines-per-inch*][,*P*]
where *device* is: LPT1, LPT2 or LPT3
characters-per-line is: either 80 or 132 (the default is 80)
lines-per-inch is: either 6 or 8 (the default is 6)

Notes The default value for a particular setting is used if this is either omitted or the setting you give is invalid.

If you want to use all but one of the default settings, put a comma in for each of the parameters you want the default setting for up to the parameter you actually want to set. For example, if you just want to set the number of lines per inch (the second parameter), use a command line of the form:

MODE LPT*n*:,*lines-per-inch*

Use the **P** setting if your PC can send data to your printer very much faster than the printer can output it on paper. The **P** setting instructs MS-DOS to try to send output to the printer continuously. However, if there is no response from the printer, for example because the printer is off-line, the message:

Infinite retry on parallel printer timeout

will be displayed (see Appendix VII: Troubleshooting).

If you set either the number of characters per line or the number of lines per inch, messages confirming that these values are now in force are displayed as they are set.

The message **LPT*n*: not redirected** is displayed when you use this version of the MODE command, to tell you that any previous redirection to a serial port has been broken.

● **To set up a communications link**

Form `MODE device: baud[, [parity][, [databits][, [stopbits][, P]]]`

where *device* is: COM1 or COM2

baud is: 110, 150, 300, 600, 1200, 2400, 4800 or 9600

parity is: N (ie. none), O (ie. odd) or E (ie. even)

databits is: either 7 or 8

stopbits is: either 1 or 2

Notes *baud* sets the transmission rate and must be included. At least the first two digits of the baud setting must be entered.

The default value for a particular setting is used if this is either omitted or the setting you give is invalid. For COM1, these are Even parity and 7 databits. If *baud* is 110, then the default number of stopbits is 2. Otherwise the default number of stopbits is 1.

If you want to use all but one of the default settings, put a comma in for each of the parameters you want the default setting for up to the parameter you actually want to set. For example, if you just want to set the number of stopbits (the fourth parameter), use a command line of the form:

`MODE COMn: baud,,, stopbits`

Use the **P** setting if you want to use the communications port for a serial printer (see 'To redirect printer output to a serial interface' below). **Note:** MS-DOS will continuously try to send output to the printer. However, if there is no response from the printer, for example because the printer is off-line, the message

Infinite retry on parallel printer timeout

will be displayed (see Appendix VII: Troubleshooting).

● **To adjust the screen display**

Form `MODE display`

- Options** `40` 40 characters per line
`80` 80 characters per line
`MONO` 80 characters per line monochrome display adapter
`C040` 40 characters per line and colour enabled
`C080` 80 characters per line and colour enabled

● **To redirect printer output to a serial interface**

To make the redirection:

Form `MODE LPTn:=COMm:`

where `LPTn` is: LPT1, LPT2 or LPT3

`COMm` is: COM1 or COM2

To go back to normal operation:

Form `MODE LPTn:[setting[,setting...]]`

Notes This redirection is used to send printer output to a serial printer, attached to a serial interface. To redirect output normally sent to the Parallel Printer port on the back your AMSTRAD PC to the Serial Interface (also on the back of your machine), use the command line:

`MODE LPT1:=COM1:`

The message `LPTn: redirected to COMm:` is displayed to confirm the redirection.

If your parallel printer needs any special settings, set these when you return printer output to the parallel printer port, even if you have set them before. Otherwise the default settings will be used.

Examples

- To set the line pitch (the number of lines per inch) on the parallel printer attached to the Parallel Printer port to 8, use the command line:

`MODE LPT1: ,8`

(assuming that the external command `MODE` is stored in the default directory or in a directory that MS-DOS automatically searches – see Section 4.2.4)

MODE will respond with the message:

Printer lines per inch set

- To set up the AMSTRAD PC's Serial Interface for linking with BT's Telecom Gold electronic mail service (300 baud, even parity, 7 data bits, 1 stop bit), use the command line:

`MODE COM1:300,E,7,1`

MS-DOS will respond with the message:

`COM1:300,e,7,1,-`

- To set the screen display to 40 characters per line, use the command line:

`MODE 40`

- To redirect printer output to a serial printer attached to the Serial Interface, use the command line:

`MODE LPT1:=COM1:`

MODE will respond with the message:

LPT1: redirected to COM1:

-
- To return to sending printer output to the parallel printer port, use the command line:

MODE LPT1:

unless your printer needs a special requirement, for example you need to instruct MS-DOS to try sending data to the printer continuously. Then you will need a command line like:

MODE LPT1:,,P

MODE will respond with the message:

LPT1: not redirected

to show that the connection to COM1 is no longer in force.

PROMPT

Internal command

PROMPT *prompt-text*

Set up a new system prompt

PROMPT is used to set up a new system prompt message. This can contain simple text and/or information such as the date, the time and the MS-DOS version number as well as or instead of the standard details (the default drive). The new prompt is then used until the computer is reset.

The position of any special information you want to include in the prompt text (eg. the date) is marked by a \$ followed by a particular character. This representation is also used for some special characters, including \$ itself.

If no prompt text is given, the system prompt goes back to the standard prompt - the default drive followed by a >

Form PROMPT [*prompt-text*]

where *prompt-text* is: *letter*[\$*character*][*letter*[\$*character*...]]

\$*character* is used to represent an information string or a special character as in the table below.

\$t	Time
\$d	Date
\$n	The drive-letter of the default drive
\$p	The current directory on the default drive
\$v	The MS-DOS version number
\$\$	A \$ character
\$g	A > character
\$l	A < character
\$b	A character
\$q	A = character
\$h	A Backspace character
\$e	An ESCape character
\$_	A new line

Any other characters after a \$ are ignored.

Example

If you would like the system prompt to have the following form:

Date Time(hours and minutes)
Default-drive Current-directory>

You will need:

\$d	To give you the date
A couple of spaces	To separate the date from the time
\$t	To give you the time
\$h\$h\$h\$h\$h\$h	To backspace over the seconds and hundredths of a second in the time
\$_	To give you a new line
\$n	To give the default drive
:	To give a colon character
\$p	To give the current directory
\$g	To give a > character.

The command line to use is therefore:

```
PROMPT $d $t$h$h$h$h$h$h$_$n:$p$g
```

TIME

Internal command

TIME [hh:mm]

Set or read the time

TIME is used either to display or set your PC's clock. This is a 24-hour clock which is maintained in battery-backed RAM. Its settings are used to time stamp files and it is therefore advisable to check that the clock has not been reset because the batteries are going flat. If this happens, renew the batteries (see Appendix II) and then reset the clock.

Any time you type in is checked before it is accepted. If the time is invalid, you will be asked to type in a new time.

Form TIME

or TIME hh:mm

where *hh* represents the hour (00...23) and *mm* the minute (00...59).

Notes If you type TIME, the current setting is displayed and then you are asked to type in a new time. If the time is correct, just press

The clock is set when you press . To make the setting accurate, type in a time 15...30 seconds in the future and then press when this time is reached. The Speaking Clock can help you set the time accurately: press on the third stroke!

Example

To set the time to be 4.23pm (16.23h), either use the command line:

```
TIME 16:23
```

which does the whole job in one go (press when it is exactly 4.23pm), or just:

```
TIME
```

If you use the second command, you will see something like this on the screen:

```
A>time
Current time is 12:24:31.33
Enter new time:
```

Type:

```
16:23
```

and press when it is exactly 4.23pm.

8. SUMMARY OF MS-DOS COMMANDS

- APPEND** External command (Section 4.2)
Set a search path for data files
APPEND [d:]\path[; [d:]\path...]
- ASSIGN** External command (Section 4.1)
Assigns drive letter to another drive
ASSIGN requested-drive=searched-drive
- ATTRIB** External command (Section 5.3)
Set file attributes
ATTRIB [+R|-R] [+A|-A] [d:]\[\][path\]filename.filetype
- BACKUP** External command (Part I, Section 4)
Saves the contents of your Hard Disk (if fitted) to floppy disk.
BACKUP [d:]\[\][path\][filename.filetype]d: [option[option...]]
- BREAK** Internal command (Section 4.2)
Sets how often MS-DOS checks for Ctrl-Break
BREAK ON|OFF
- CHDIR** Internal command (Section 4.1)
Change the current directory
CHDIR [d:]\[\]path
CD [d:]\[\]path
- CHKDSK** External command (Section 6.3)
Check disk for errors and file for non-contiguous storage areas
CHKDSK d: \[\][path\][filename.filetype][/F][/V]
- CLS** Internal command (Section 4.1)
Clear the screen
CLS
- COMMAND** External command (not covered in this manual)
Start the command processor from a higher level
COMMAND [d:]\[\][path][device][option[option...]]
- COMP** External command (Section 5.2)
Compare files
COMP [option[option...]] [d:]\[\][path\]filename.filetype [d:]\[\][path\]filename.filetype

-
- COPY** Internal command (Section 5.2)
Copy files
COPY [d:][\][path\]source[/A][/B] [d:][\][path\]destination[/A][/B][/V]
- CTTY** Internal command (Section 7.1)
Change the device used to issue commands
CTTY device
- DATE** Internal command (Section 7.3)
Set or read the date
DATE [dd-mm-yy]
- DEBUG** Debugging utility (not covered in this manual)
DEBUG [d:][\][path\][filename.filetype] [argument[argument...]]
- DEL** Internal command (Section 5.2)
Delete a file
DEL [d:][\][path\]filename.filetype
- DIR** Internal command (Section 4.1)
Display directory
DIR [d:][\][path\][filename.filetype][/P][/W]
- DISKCOMP** External command (Section 6.4)
Compare contents of target drive against contents of source drive
DISKCOMP source-drive: target-drive: [/1][/8]
- DISKCOPY** External command (Section 6.2)
Copy contents of source drive to target drive
DISKCOPY source-drive: target-drive:
- ECHO** Batch subcommand (Section 4.4)
Control echoing of commands on the screen
ECHO [ON|OFF] [remark]
- EDLIN** Text editor (Section 5.2)
Edit text
EDLIN [d:][\][path\]filename.filetype[/B]
- ERASE** Internal command (Section 5.2)
Delete a file
ERASE [d:][\][path\]filename.filetype

- EXE2BIN** External command (not covered in this manual)
Convert .EXE files to binary format
EXE2BIN [d:][\][path\]filename.EXE [d:][\][path\][filename.filetype]
where *filetype* is **COM** or **BIN**
- EXIT** Internal command (not covered in this manual)
Exit from COMMAND.COM and return to the previous level (if any)
EXIT
- FDISK** External command
Configure your PC's hard disk (if it has one)
FDISK
- FIND** External command and external filter (Section 4.3)
Look for a string in a file
FIND [/V][/C][/N] "string" [d:][\][path\]filename.filetype
- FOR** Batch subcommand (Section 4.4)
FOR is used to execute a number of similar commands.
FOR %%parameter **IN** (value[value...]) **DO** command
- FORMAT** External command (Section 6.1)
Format the disk in the specified drive
FORMAT d: [option[option...]]
- GOTO** Batch subcommand (Section 4.4)
Go to a labelled point in the file
GOTO label
- GRAFTABL** External command (Appendix I) (Only for use with PC CD and ECD in low resolution (8×8) character modes)
Load additional character table (for use in graphics mode)
GRAFTABL
- GRAPHICS** External command (Section 4.2) (Only for use with PC CD and ECD in CGA mode)
Prepare your PC to print graphics screen displays
GRAPHICS printer-type[/R][/B]
- IF** Batch subcommand (Section 4.4)
IF [NOT] condition command
- JOIN** External command (Section 4.1)
Join a disk drive into another disk's directory structure
JOIN d: [d:][\]path

- KEYBUK** External command (Appendix V)
Configure keyboard
KEYBUK
- LABEL** External command (Section 7.2)
Create or change a disk label
LABEL *[d:] label*
- LINK** Object Linker (not covered in this manual)
LINK
- MDGRAPH** External command (Section 4.2) (Only for use with PC MD)
Prepare your PC to print graphics screen displays
MDGRAPH
- MKDIR** Internal command (Section 5.1)
Make a new directory
MKDIR *[d:]\[path]*
MD *[d:]\[path]*
- MODE** External command (Section 7.1)
Sets mode of operation of input and output devices
MODE *device: setting[, setting...]*
- MORE** External filter (Section 4.3)
Make output be displayed one screenful at a time
MORE
- PARK** External command (Part I, Section 4)
Prepares your Hard Disk (if fitted) before moving it
PARK*[d:]*
- PATH** Internal command (Section 4.2)
Define a search path
PATH *[d:]\path[; [d:]\path...]*
- PAUSE** Batch subcommand (Section 4.4)
Pause while processing
PAUSE *[remark]*
- PRINT** External command (Section 5.2)
Print text files in the background
PRINT *[d:]\[path\]filename filetype [[d:]\[path\]filename filetype...]*
[/P][/C][/T]

PROMPT Internal command (Section 7.2)
 Set up a new system prompt
PROMPT *prompt-text*

RECOVER External command (not covered in this manual)
 Recover a file or disk containing bad sectors
RECOVER *d:[\][path\][filename.filetype]*

RESTORE External command (Part I, Section 4)
 Copies files made by a previous BACKUP command to your Hard Disk (if fitted)
RESTORE *d:[d:][\][path\][filename.filetype][option[option...]]*

REM Batch subcommand (Section 4.4)
 Display remark
REM *remark*

RENAME Internal command (Section 5.2)
 Rename a file
REN *[d:][\][path\]old-name new-name*

REPLACE External command (Section 5.3)
 Insert new files and update old versions
REPLACE *[d:][\][path\]filename.filetype [d:][\][path][option[option...]]*

RMDIR Internal command (Section 5.1)
 Remove a directory
RMDIR *[d:][\]path*
RD *[d:][\]path*

SET Internal command (Section 4.1)
 Set a parameter to a string
SET *parameter=string*

SHARE External command (not covered in this manual)
 Install file sharing and locking
SHARE *[/F:space][/L:locks]*

SHIFT Batch subcommand (Section 4.4)
 Shift the dummy parameters
SHIFT

SORT External command and filter (Section 4.3)
 Sort data
SORT *[/R][/+n] <[d:][\][path\]filename.filetype [>destination]*

HARD DRIVE
IS :E

← THIS OVER
TO GET INTO
HD :C

PRESS
DIR (SPACE) C :
TO CALL HD
DIR.WP
OR
DIR (S) C:W

- SUBST** External command (Section 4.1)
Substitute the name of an imaginary drive for a path
SUBST *d: [d:][\]path*
- SYS** External command (Section 6.1)
Copy system files to the disk in the specified drive
SYS *d:*
- TIME** Internal command (Section 7.3)
Set or read the time
TIME *[hh:mm]*
- TREE** External command (Section 5.1)
Display the pattern of directories on a drive
TREE *[d:][[/F]*
- TYPE** Internal command (Section 5.2)
List a simple text file
TYPE *[d:][\][path\]filename.filetype*
- VER** Internal command (Section 4.1)
Display MS-DOS version number
VER
- VERIFY** Internal command (Section 4.1)
Turn on and turn off verification of all writes to disk
VERIFY *ON|OFF*
- VOL** Internal command (Section 5.2)
Display disk volume label
VOL *d:*
- XCOPY** External command (Section 5.2)
Copy files and directories
XCOPY *[d:][\][path\]source [d:][\][path\]destination [option[option...]]*

Batch commands

- BATCH** Internal commands (Section 4.4)
Run a batch of commands
[d:][\][path\]filename [value[value...]]
- ECHO** Batch subcommand
Control echoing of commands on the screen
ECHO *[ON|OFF|remark]*
- FOR** Batch subcommand
FOR is used to execute a number of similar commands.
FOR %%parameter **IN** (value[value...]) **DO** command
- GOTO** Batch subcommand
Go to a labelled point in the file
GOTO *label*
- IF** Batch subcommand
IF *[NOT] condition command*
- PAUSE** Batch subcommand
Pause while processing
PAUSE *[remark]*
- REM** Batch subcommand
Display remark
REM *remark*
- SHIFT** Batch subcommand
Shift the dummy parameters
SHIFT

1000

PART IV: LOCOMOTIVE BASIC 2

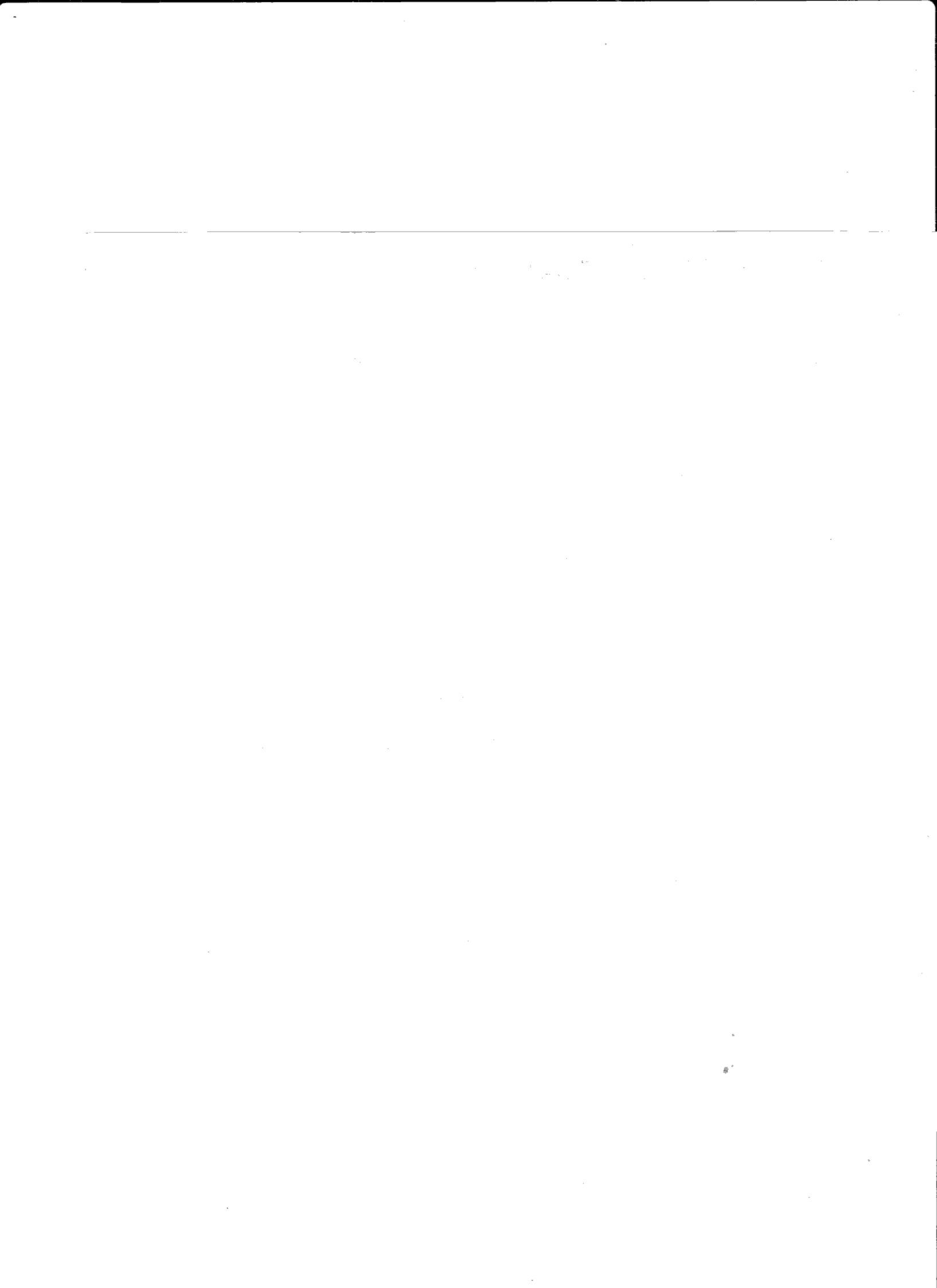

CONTENTS

<i>1. An Introduction to BASIC 2</i>	<i>387</i>
What BASIC 2 is for	387
Entering BASIC 2	387
Using BASIC 2	389
Keyboard and mouse	
Menus	
Windows	
Text and graphics	
Leaving BASIC 2	392
<i>2. A Guided Tour of BASIC 2</i>	<i>393</i>
Running a program from the Desktop	393
Drawing circles, boxes, ellipses . . .	394
Different ways of outputting text	396
Preparing a program	397
<i>3. The BASIC 2 Menus and Function keys</i>	<i>399</i>
3.1 The File menu	399
3.2 The Program menu	399
3.3 The Edit menu	400
3.4 The Fonts menu	401

3.5 The Colours menu	402
3.6 The Patterns menu	403
3.7 The Lines menu	403
3.8 The Windows menu	404
3.9 The BASIC 2 menu	404
3.10 The Function keys	404

4. BASIC 2 Commands **405**

4.1 Commands for manipulating data	405
4.2 Program control	406
4.3 Input and Output of data	407
4.4 Screen Graphics	408
4.5 Turtle Graphics	409
4.6 Advanced features of BASIC 2	409
Manipulating strings of characters	
Error trapping	
Screen handling	
File handling	
Accessing records by word-keys	

1. AN INTRODUCTION TO BASIC 2

What BASIC 2 is for

BASIC 2 is a programming language, for preparing and using programs to solve problems involving logic, calculation, text and graphics (pictures), and data handling.

Its main ancestor is the original BASIC programming language, designed many years ago as a programming language that was simple to learn, to aid teaching. Since then, many versions of BASIC have been developed, mainly to run on modern microcomputers. BASIC 2 is a powerful BASIC enhanced with many structuring features and designed to run in a GEM environment to take advantage of many of its attractive features.

BASIC 2 has many advantages over more ordinary BASICs, such as:

- **easy access to facilities, through GEM menus**
- **attractive, easy-to-use GEM graphics and turtle graphics**
- **flexible use of the display, through GEM windows**
- **easy use of indexed (database-like) disk files**

You can use BASIC 2 very simply and easily as a kind of sophisticated calculator. Its main role, however, is as a programming language, for developing and using programs.

BASIC 2 programs can be used for a wide range of different tasks, from simple things such as totalling sequences of figures, to complex jobs such as drawing pictures, calculating a payroll, performing statistical analysis or displaying and manipulating complex graphs.

BASIC 2 allows you to use suitable programs written by others, as well as writing and using your own. It is a very versatile language which can be used to perform most tasks that involve manipulating numbers or text.

This chapter provides a brief introduction to BASIC 2. After reading it, we suggest you go on the Guided Tour provided by Chapter 2 – to see for yourself what BASIC 2 can do.

Note: We only give an overview of Locomotive BASIC 2 in this manual. If you want to know more, there is a comprehensive User Guide (published by AMSTRAD) and a full Technical Reference (available from Locomotive Software).

Entering BASIC 2

To use BASIC 2, you must first enter GEM, then open BASIC 2 as an application, from the GEM Desktop. BASIC 2 is supplied on the GEM Desktop disk (Disk 3), so if you use a copy of this disk as your Desktop disk, you can go straight on to using BASIC 2 without changing the disk in your drive. In the case of a Hard Disk PC the BASIC 2 folder is already displayed (on the C: drive).

The steps are as follows:

Note: If anything happens while you work through these instructions that isn't explained here, turn to Appendix VII 'Troubleshooting' and see if you can find out what has gone wrong. If in doubt, consult your dealer.

- 1 Display the GEM Desktop, with one of the directory windows showing the root directory of Drive A (A:\) or Drive C (C:\) if you have a PC HD.**

If you are not sure how to do this, either reset your PC (see Part I, Section 8.3) or go through the Startup procedure described in Part I, Section 8.1.

- 2 Place the Desktop disk in Drive A (the lefthand drive if you have two) and then press **[Esc]****



- 3 Move the pointer to the BASIC2 folder and double-click the lefthand mouse button.**

The contents of the BASIC2 folder should now be displayed in this window (see below). If the folder is merely highlighted, you didn't double-click at the right speed. Try double-clicking the mouse button again - perhaps varying the speed at which you click - until you see the following display:

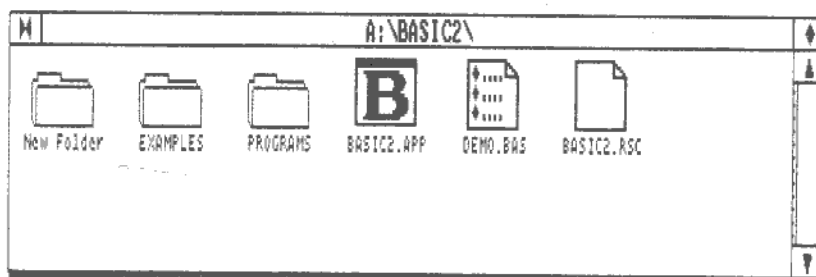

- 4 Move the pointer to the BASIC2 program icon and double-click the lefthand mouse button. Alternatively, if you want to run a particular BASIC program you have stored on disk, move the pointer to this program's icon and double-click the lefthand mouse button.**

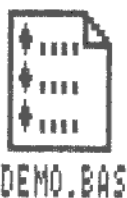

The pointer should be replaced by an hour glass and the BASIC 2 software read into the PC's memory. If the icon merely becomes highlighted, try double-clicking the mouse button again - perhaps varying the speed at which you click, or use the **Open...** option in the File menu.

Once the software has been read into your PC's memory, the screen should show something like this:

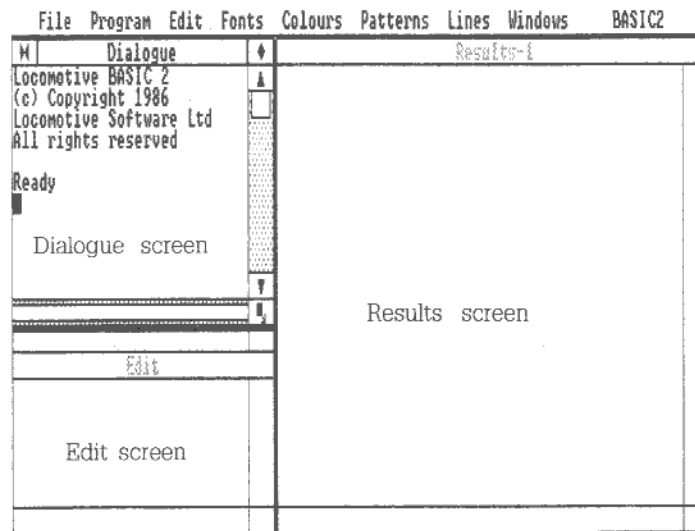

If BASIC 2 doesn't load, it probably means that there isn't enough memory available for the program to run. Reset your PC and try again. If BASIC 2 still fails to load, turn to Appendix VII and read the advice given in Section VII.2.

Using BASIC 2

The operation of items such as windows, menus and mouse in BASIC 2 is much the same as in other GEM applications, although of course the functions they perform are all concerned with preparing and running BASIC 2 programs. The description of using these items is therefore very brief: turn to Part II, Chapter 2 for details if you are not familiar with using GEM applications.

Keyboard and mouse

BASIC 2 is controlled using two main devices: the mouse and keyboard.

The mouse is used to select menu options, move and scroll windows, move the text cursor, etc.

The keyboard is used to type text and numbers, such as commands, file names, or the lines of a program you are writing and as an alternative to using the mouse.

The general details of these devices are given in Parts I and II of this manual. However, the following keystrokes have particular importance when using BASIC 2:

 - this is used to complete instructions, program lines and replies to requests for information when using programs and menu options

Ctrl-C (ie. hold down the  key and press **[C]**) - this is used to interrupt whatever BASIC 2 is doing, for example to stop a program while it is running.

Many menu options can be selected by pressing single keys, instead of using the mouse. Where this is the case, the key to use will be shown in the menu, at the extreme right of the option's line. However, these keystrokes can only be used when there isn't a menu on the screen.

Be careful to distinguish between the keys used to type the number zero (0) and the letter 'Oh' (O). While they look similar, they are NOT interchangeable!

Menus

Menus provide you with lists of related commands or options, that can be picked using the mouse. They are used to help save you time and effort, by presenting you with a list of available options, rather than expecting you to remember lots of commands.

To view the options in a menu, select it by moving the mouse pointer to its title in the menu bar. This causes the list of options in the menu to 'drop' onto the screen. Some of the options may not be available – these are shown fainter than those that are available.

To remove a menu from the screen, move the mouse to anywhere outside the menu and click the lefthand mouse button.

To select an option from a menu, select the menu, then move the mouse pointer to the option required when it will be highlighted, then click. Don't select any options until you are using BASIC 2 for real; if you do, cancel them by selecting the [Cancel] exit button (if a Dialog box appears on the screen) or by pressing Ctrl-C.

The options in each menu are described in detail in Chapter 3.

Windows

A window is simply a rectangular area of the screen used to display text or graphics. GEM allows you to have several windows on the screen at the same time, almost like having several separate screens. BASIC 2 uses each GEM window to provide a view of part of a larger underlying area, known as a virtual screen.

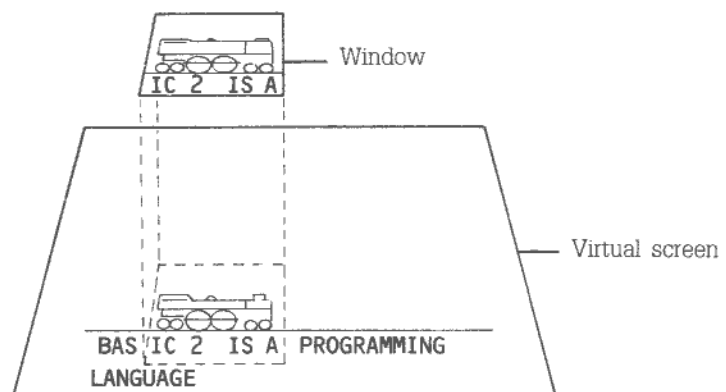

Windows can be:

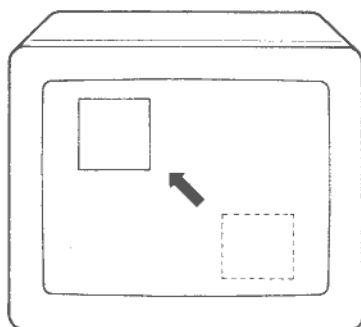

moved around the screen

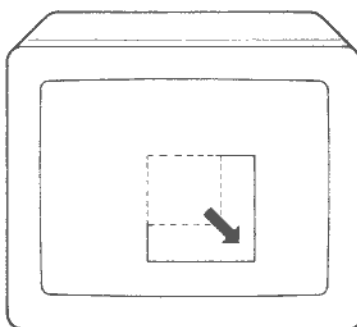

changed in size or shape

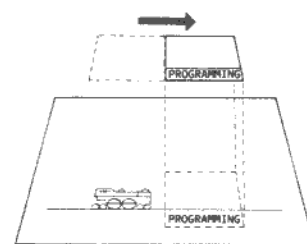

scrolled – moved across the virtual screen to reveal a different part

Windows are independent of each other, but when two meet on the screen, one is considered to be in front of the other and it obscures your view of the overlapped part of the other.

BASIC 2 allows you to use up to four windows. All of these are placed on the display when you first select BASIC 2. Their size, position and behaviour are not fixed; these can be altered using the mouse and/or BASIC 2 commands. (The details of the various techniques for changing the size, moving and closing windows with the mouse are given in Part II, Chapter 2.)

The four windows are called:

Dialogue: This window is used for commands you want obeyed immediately – in particular, commands like **RUN** and **EDIT**. If you want to use BASIC 2 as a simple calculator, you type commands like **? 42*1964** in the Dialogue window. This is known as using BASIC 2 in Direct Mode.

Edit: The Edit window shows the program you are working with and is used to change it. If you type **EDIT** in the Dialogue window, you are automatically put into the Edit window so that you can start editing the program.

Results-1 and **Results-2:** These are used for output from your programs. BASIC 2 is initially set up so that output is sent to the Results-1 window unless you specifically tell BASIC 2 to send it somewhere else. Both text and graphics can be sent to Results-1. Results-2 is initially hidden behind the Dialogue and Edit windows (you can see it if you move these windows away from the lefthand edge of the screen) but it is available if, say, you want to keep the text output from your program separate from the graphics output. (As Results-2 is set up, it can only be used for text.)

Note: BASIC 2 may only put up three windows – Dialogue, Edit and Results-1. This indicates that there wasn't enough memory available to put up the fourth window. If you need Results-2, reset your PC and load BASIC 2 again.

Text and graphics

BASIC 2 provides an enormous variety of graphics and text facilities.

Select the Colour menu with your mouse to see the colours available for text and graphics. The current text and graphics colours are indicated in the menu with arrows. If you select the Patterns menu, you will see all the different patterns that are available for filling shapes that you draw on the screen. The Lines menu shows you the different styles, thicknesses and end-styles you can use when drawing lines.

To see the text styles available, select the Fonts menu. This shows the available fonts (which have names like 'Swiss' and 'Dutch'), pitches and emphases (skewed, thickened, lightened and underlined). If an option is shown in light text, you cannot use it with the current font.

We shall demonstrate the effects you can produce by selecting different options from these menus in Chapter 2. You can also use these effects from the BASIC commands you write by adding phrases like **COLOUR *n*** or **FILL WITH *n*** to the end of your commands.

Leaving BASIC 2

When you have finished using BASIC 2 and want to use another GEM application, you should leave BASIC 2 and return to the GEM Desktop by selecting the **Quit** option from the File menu.

This will lose any program you have been working with. If you want to keep it, first select the **Save** option in the File menu. This puts the Item Selector Dialog box on the screen: use this to specify which file you want to store the program in.

2. A GUIDED TOUR OF BASIC 2

This chapter takes you on a guided tour of the facilities of BASIC 2. On this tour, you will be shown:

- how to run a BASIC 2 program from the GEM Desktop
- how to tell BASIC2 to draw a variety of shapes and fill these with different patterns
- how to write messages on the screen in a range of different text sizes, styles, colours...
- how to prepare a program and edit it – and what happens when there is something wrong with your program

The first thing to do is to display the GEM Desktop. If you are not sure how to do this, either reset your PC (see Part I, Section 8.3) or work through the Startup procedure (see Part I, Section 8.1).

Running a program from the Desktop

All the BASIC 2 programs are supplied in the BASIC2 folder on Disk 3 of your AMSTRAD PC disks (the GEM Desktop and BASIC 2 disk), so work through this guided tour with a copy of this disk in your Drive A.

The BASIC2 folder is in the Root directory of this disk (the A:\ directory), so start by showing this directory in one of your Desktop windows. You may need to click on the window's Close box (the 'bow-tie') a few times to work back to the Root directory from the folder you are currently working on. If you are not sure about directories and files, read Part I, Chapter 1; if you are not sure about clicking the mouse buttons and using menus, read Part II, Chapter 2.

When you have the Root directory on the screen, move the pointer to the BASIC2 folder icon. This should be near the top of the directory. When the pointer is on this icon, double-click the lefthand mouse button or click it once and then select the **Open** option from the File menu.

When the new directory appears on the screen (the A:\BASIC2\ directory), move the pointer to the DEMO.BAS icon. When the pointer is on this icon, double-click the lefthand mouse button or click it once and then select the **Open** option from the File menu.



After a short while, you will be able to see that your PC is loading the BASIC2.APP program and you will briefly see the initial BASIC 2 screen that we showed in Chapter 1. But if you look at the Dialogue window, you will see the command **Run** and then as you wait, you will see further activity both in the Edit window and in the Results-1 window.

Watch what happens closely. What you are running is a special demonstration program that has been put together to show you the sort of commands you might use (shown in the Edit window) and the results these commands will have (in the

Results-1 window). It demonstrates how just a few straightforward BASIC 2 commands create some really attractive graphics.

When the program has finished, you will be asked whether you want to continue using BASIC 2 or whether you want to return to the GEM Desktop. Type **Y**

You will now see the word **Ready** in the Dialogue box, followed by a cursor to show you that BASIC 2 is ready for you to type other commands. As we would like a clear Results-1 screen for the next stage of the tour, type the command **CLS** and press . You will see the Results-1 window clear and once again you will see a **Ready** in the Dialogue window.

Note that everything you type appears in the Dialogue window. This is because you are using BASIC 2 in its Direct Mode, ie. it is immediately processing every command you type in.

Drawing circles, boxes, ellipses...

BASIC 2 has a number of graphics commands, for drawing pictures on the screen, dot matrix printers, pen plotters, etc. A number of these were shown in the demonstration program. We shall now show how simple it is to draw these shapes for yourself.

The commands all have names that reflect the type of shape you want to draw. To draw a circle you use a **CIRCLE** command; to draw a box you use the a **BOX** command; to plot a number of points you use the **PLOT** command.

Try typing the command:

```
CIRCLE 500;500, 300 
```

This draws a circle on the Results-1 screen with its centre at 500;500 and radius 300. These numbers are in 'user coordinates': user coordinates are specified in such a way that drawing shapes in the square Results-1 window you have on the screen when you start using BASIC 2 is very like drawing the same shapes on a square piece of graph paper with 5000 divisions on each side. Try altering the numbers used in the command to see how they affect the size and position of the circle drawn.

The colour (only black and white on a monochrome screen) and style of line used to draw the circle can be changed by using menu or command options. Select the Colour and Lines menus with your mouse to see which options are available. The colour and line style etc. that you have just used are marked with small arrows.

Select a different colour (set a graphics colour because you will use it to draw graphics) and/or line style, then repeat the above command. The Lines menu lets you set the style of line, its thickness and the 'end-styles' short lines will have, but you will have to keep bringing the menu onto the screen because GEM closes up the menu after you make each selection.

Another command to try is the **BOX** command. Try, for example, typing the command:

```
BOX 300;2500, 3000, 2000 
```

This draws a rectangle 3000 user coordinates wide, 2000 user coordinates high, with its bottom lefthand corner at 300;2500. Once again, you can use the Colours and Lines menus to change the appearance of the rectangle.

The next command to try is:

```
CIRCLE 1000;1000, 500 FILL 
```

The first part of this command tells BASIC 2 to draw a circle centred at 1000;1000 and radius 500. The extra **FILL** tells it to fill the circle it draws.

The pattern it uses to fill the circle is the one currently set in the Patterns menu. If you select this menu, you will see the range of patterns that are available: the one that has just been used is the one with the small arrow beside it. Select a different pattern and then type the command again, perhaps varying the position and radius of the circle. Or you can try replacing **FILL** with **FILL WITH *n***, where *n* is a number between 0 and 38.

Adding the word **FILL** to a **BOX** command or any of the other shape commands similarly tells BASIC 2 to draw the shape and then fill it with the selected pattern. The other shape commands are listed and explained in Section 4.4.

Another change you can make to the **BOX** command is to add the word **ROUNDED** to the command. This draws a rectangle as before, but this time it gives it rounded corners. To see this, type a command like:

```
BOX 300;200, 3000, 2000 FILL ROUNDED 
```

Turtle graphics

Another way to draw graphics is by moving a 'turtle' around the screen. The turtle is just a special form of pointer.

To see a turtle in your Results-1 window, type:

```
GRAPHICS CURSOR 3   
WINDOW CURSOR ON 
```

If you have used the LOGO programming language, you will find many of BASIC 2's turtle graphics commands very familiar. For example, to draw a line of length 500 in the direction the turtle is pointing, type:

```
FORWARD 500 
```

To turn the turtle's head, use the commands **LEFT** (anticlockwise) or **RIGHT** (clockwise), followed by an angle (usually in radians). For example:

```
LEFT 1 
```

will turn the turtle 1 radian (approximately 60 degrees) anticlockwise. (If you prefer to work in degrees, select the **Angles in...** option in the Program menu and click on [Degrees] in the Dialog box that appears: then you could get a similar result by typing **LEFT 60**)

Try using sequences of **LEFT**, **RIGHT** and **FORWARD** commands. (**FORWARD** can be shortened to **FD**; **LEFT** to **LT**; and **RIGHT** to **RT**.) Try using different line colours and styles, by selecting options from the Line and Colour menus.

If you turn to Section 4.5, you will find other turtle graphics commands you can try.

When you have finished working with the turtle, turn its cursor off by typing:

```
WINDOW CURSOR OFF 
```

Different ways of outputting text

Type:

```
PRINT "Text output" [↵]
```

This will simply print the text 'Text output' in the Results-1 window. It will probably be printed using the standard ('System') text style. Once again, different colour and styles can be produced by using menu options.

The colour is changed by setting a text colour through the Colour menu. The text style (or 'font'), the size of the characters and their emphasis (thickened, lightened, skewed or underlined) are changed through the Fonts menu.

Select the Colour and Fonts menus and see what options are available. Try selecting a different text colour and a different font etc. It may take several selections of the Fonts menu to set the full combination of text style, character size and emphasis you want because GEM automatically closes up the menu as you make each selection. Again, you can also set all these effects by including special phrases in your BASIC commands.

See what happens this time when you type:

```
PRINT "Text output" [↵]
```

There is, by the way, a shorthand way of repeating your last command – type Ctrl-A (ie. hold down [Ctrl] and press [A]) and then press [↵]

You can also display text in the other windows. For example, to display text in the Results-2 window, type:

```
PRINT #2, "Text in the Results-2 window" [↵]
```

To start with, you won't be able to see this text, but it is there! The Results-2 window is initially hidden behind the Dialogue and Edit windows. To see it, move your mouse to the Dialogue window title bar, hold down the lefthand mouse button and drag the window down and to the right.

If you compare this message with the last one you printed to the Results-1 window, you will see that they probably aren't the same colour and the font, character size and emphasis you set haven't been used for the Results-2 text. The reason for this is that the settings you have made in the menus **only apply to the default screen** – that is, the screen BASIC 2 sends output to unless you tell it otherwise.

To make Results-2 the default screen, type the command:

```
STREAM #2 [↵]
```

After you have typed this command, pull down the menus one by one and see what effect changing the default screen has had. As you will see, the Lines and Patterns menus are now completely denuded and many of the Fonts options are no longer available.

The reason for this is that Results-2 is a Text screen, whereas Results-1 was a Graphics screen. You can't draw any graphics on a text screen and you are limited to a fixed set of System characters to use for writing text. However, you can still set the colour the text is written in.

When you want to return to using Results-1 as the default screen, type:

```
STREAM #1 [↵]
```

Preparing a program

To show how programs are prepared using BASIC 2, we shall now write a short BASIC program to draw a series of circles.

As you have just been using another BASIC program, the demonstration program, start by pulling down the Program menu and selecting **New**. This clears the current program so that you can start work on another program – rather like selecting a fresh piece of paper to work on.

Now bring the Edit menu onto the screen and select the **Edit** option. This automatically moves you to the Edit window. Anything you type now will appear in the Edit window. (You will see the command **Edit** appear in the Dialogue window as if you had typed this command yourself.)

The program we are going to type is:

```
FOR I=1 TO 10
CIRCLE 2500,2500,200*I
NEXT
END
```

If you have programmed in BASIC before, you will immediately notice something about BASIC 2 – it doesn't need a line number at the beginning of each line (though you can put one in if you like).

Type the lines in lower case, pressing at the end of each line. As you do this, you will notice various things happening:

- Immediately you start typing and after you press , a ♦ appears at the beginning of each program line.
- As you finish each line, the command names are converted to upper case. This gives you a simple way of checking that you have typed the command names correctly, because if you had misspelt one it would be left in lower case. Similarly, if one of your variables gets converted to upper case, this means that you are trying to use a BASIC 2 keyword as a variable – which will make your program fail.

To run the program, pull down the Edit menu and select **Exit Edit**. Then pull down the Program menu and select **Run**. You will see the command **Run** appear in the Dialogue window as if you had moved to this window and typed the command yourself.

This will shortly be followed by **Syntax error** – because there was a deliberate mistake in the second line of program. The correct line is:

```
CIRCLE 2500;2500,200*I
```

Because an error has occurred, you have automatically been put back into the Edit window and the cursor is on the line that is wrong.

Use the cursor keys to move to the **2** after the first comma, press to delete the comma, and type **;** Then select **Exit Edit** and **Run** as before. The program should now run.

You could now go on and change this program so that it does something more exciting. Chapter 4 introduces you to the commands that are available in BASIC 2 and Sections 4.4 and 4.5 give details of graphics commands you might like to try

out. Just select **Edit** from the Edit menu to start changing the program, and select **Exit Edit** and then **Run** to see the effect of your changes.

If you want to save the program you create, pull down the File menu and select **Save**. This saves your program as a simple text file.

When you have finished using BASIC 2, pull down the File menu and select **Quit**. You will then be returned to the GEM Desktop.

3. THE BASIC 2 MENUS AND FUNCTION KEYS

This is a reference chapter giving a summary of the options available through menus or by pressing function keys while you are using BASIC 2.

3.1 The File menu

```
Load ...
Save ...
*****
Quit
```

Load... - Loads a stored BASIC program into memory, replacing any program you have been running or editing so far.

Selecting this option brings the Item Selector Dialog box onto the screen. Use this to pick out the file holding the program you want to run or edit (see Part II, Section 2.11).

Save... - Saves your current program as an ASCII text file.

Selecting this option brings the Item Selector Dialog box onto the screen. Use this to specify the file you want to store your program in (see Part II, Section 2.11).

Quit - Leave BASIC 2 and return to the GEM Desktop.

3.2 The Program menu

```
Run          F9
Stop         Ctrl-C
Continue     F7
*****
Edit         F10
List
*****
New
*****
Angles in ...
```

Run - Runs your current program.

You can also run this program either by typing the command **RUN** in the Dialogue window or by pressing the **F9** key.

Stop - Stops the program that is currently running.

You can also stop the program either by typing the command **STOP** in the Dialogue window or by pressing Ctrl-C

Continue - Makes the program resume at the point it was stopped.

You can also continue running the program by typing the command **CONT** in the Dialogue window or by pressing the **F7** key.

Edit - Goes into the Editor to edit the current program.

You can also do this by:

- pressing **F10**
- clicking in the Edit window
- typing the command **EDIT** in the Dialogue window
- selecting the Edit option in the Edit menu

If you are already in the Editor, the option becomes **Exit Edit**. Selecting this option or pressing **F10** then leaves the Editor and returns you to the Dialogue window.

List - Lists the current program on your printer.

New - Clears the current program from memory so that you can start preparing a new program.

The current program isn't saved before it is erased from memory.

Angles in ... - Selects whether angles are assumed to be in degrees or in radians.

Selecting this option brings a Dialog box onto the screen, with Radians and Degrees as options. The current selection is highlighted.

3.3 The Edit menu

Exit Edit	F10
Start area	F1
End area	F1
Cancel area	F2
Copy area	F3
Move area	F4
Delete area	F5
Insert off	Ins
Rounder	...

Edit - Goes into the Editor to edit the current program.

You can also do this by:

- pressing **F10**
- clicking in the Edit window
- typing the command **EDIT** in the Dialogue window
- selecting the Edit option in the Program menu

If you are already in the Editor, the option becomes **Exit Edit**. Selecting this option or pressing **F10** then leaves the Editor and returns you to the Dialogue window.

Start area - Marks the start of a section of program you want to copy, move or delete.

This action marks one end of the section. The other end can be either before or after the Start end.

You can also mark the start of the section by pressing **F1**

End area - Marks the end of the section of program you want to copy, move or delete.

The section of program you have marked becomes highlighted and the cursor is changed in style to remind you that a section of program is marked ready to move, copy or delete.

You can also mark the end of the section by pressing **F1**

Cancel area - Cancels the marking of a section of program.

If you wish you can stop marking the section after just positioning one end. The section of program is left in its current position.

You can also stop marking the section by pressing **F2**

Copy area - Inserts a copy of a marked section of the program at the cursor position.

You can also copy the program segment by pressing **F3**. The original program segment is unaffected.

Move area - Moves a marked section of program, removing it from its current position and inserting it at the cursor position.

You can also move the program segment by pressing **F4**

Delete area - Removes a marked section of the program.

You can also delete the program segment by pressing **F5**

Insert On/Off - Toggles whether what you type at the keyboard is inserted into your program or overwrites the existing program lines.

If program lines are currently overwritten by anything you type, selecting this option will cause what you type to be inserted and vice versa.

You can also toggle this action by pressing **Ins**.

Renumber... - updates the line numbers used in your program and puts them into the ascending sequence you specify.

Selecting this option brings a Dialog box onto the screen. This gives the current choice of first line number and the step by which line numbers should be incremented. You can change either or both of these settings (see Part II, Section 2.10) before selecting the [OK] exit option. The program is then renumbered.

Note: Only the lines which have a line number will be renumbered.

3.4 The Fonts menu

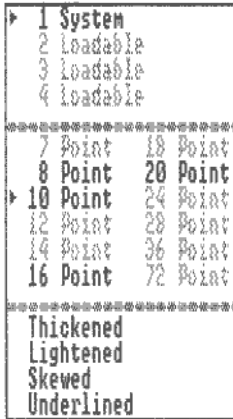

This menu is in three sections. Selections are made in each section by separate clicks of the lefthand mouse button. The small arrows mark the current selections. There can only be one arrow in each of the top two sections, but you can have any number of arrows in the bottom section.

When you click on an option in either of the top two sections, the appropriate arrow moves to your new selection. If you click on a option in the bottom section, it will become selected if it wasn't selected before but de-selected if it was selected before. As you make each selection, GEM will automatically close up the menu: bring the menu onto the screen again to make any further selections you want.

The character style, size and emphasis set in the menu will be used as the default for all future text to be displayed on the default screen until you make another selection or reset the BASIC by using a CLS RESET command.

Top section

Listed in the top section of the menu are the character styles that are available for writing text on the default screen.

System font is always available and is used on both text screens (such as Results-2) and graphics screens (such as Results-1). **Swiss** and **Dutch**, for example, are the names of the fonts listed in your computer's ASSIGN.SYS file. The **Loadable** option (if included) just indicates that BASIC 2 can work with another character style if this were to be loaded through the ASSIGN.SYS file. These other fonts are only available if your default screen is a graphics screen: they are not available on a text screen.

The numbers beside the font names are the numbers used by certain commands and functions to identify a particular character style.

Middle section

Listed in the middle section of the menu are the sizes of characters that you can use. The sizes depend on which FNT files are listed in your computer's ASSIGN.SYS file. Each of these files contains details of characters of one particular size, which can also be used to generate double-size characters.

If the size is available, it is written in normal text. If the size isn't available, it is written in lightened text.

All the options are written in lightened text when the default screen is a text screen because only one text size can be used. The different text sizes can only be used on graphics screens.

Bottom section

The bottom section lists the different character effects (or emphases) that can be applied to the text. Again these are only available when the default screen is a graphics screen.

Thickened – Emboldens the text.

Lightened – Lightens the text.

Skewed – Makes the characters slant forward, giving an italic style of text.

Underlined – Underlines the text.

Clicking on an option that is currently selected de-selects that option.

3.5 The Colours menu

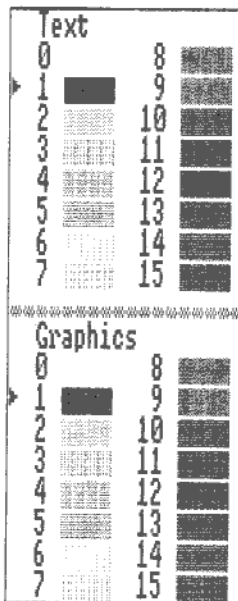

The Colours menu lists all the different colours that are available for writing text and drawing graphics. If you have a monochrome monitor, you will see that only black and white are available.

The colours set in the menu are used as the default for all following text and graphics until you make a different selection or reset BASIC by using a CLS RESET command.

The menu is in two sections because the colours for text and graphics can be chosen independently. Small arrows mark the current selections.

The numbers beside the colours are the numbers used by certain commands and functions to identify a particular colour.

3.6 The Patterns menu

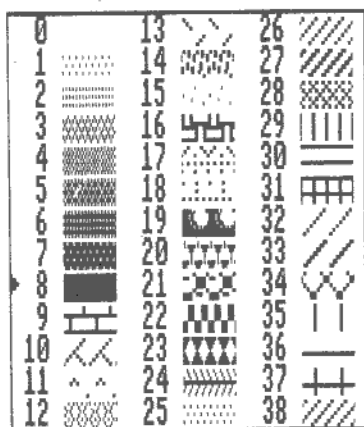

The Patterns menu lists all the different patterns that are available for filling shapes on a graphics screen. A small arrow marks the current selection. These patterns will be drawn in the current graphics colour when you use them to fill an area of the screen.

No graphics patterns can be used on a text screen.

The pattern set in the menu is used as the default pattern to fill all the shapes you ask to fill until you make another selection or reset the BASIC using a CLS RESET command.

The numbers beside the patterns are the numbers used by certain commands and functions to identify a particular pattern.

3.7 The Lines menu

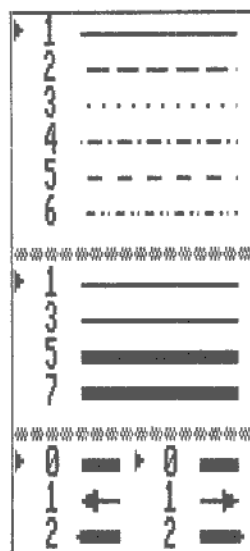

The Lines menu lists the various styles, thicknesses and end-styles available for drawing lines on graphics screens. No lines can be drawn on text screens.

The menu is in three sections, with a small arrow marking the selection in each section. Selections in each section are made by separate clicks on the lefthand mouse button. As you make each selection, GEM automatically closes up the menu: bring the menu onto the screen again if you want to make another selection.

The top section shows the six line styles; the middle section shows the four different thicknesses of line you can use; the bottom section shows on the left the three end-styles available for the start of the line and, on the right, the three end-styles available for the end of the line. The numbers are those used by certain commands and functions to identify particular line styles.

The style, thickness and end-styles set in the menu will be used as the default for any line that is drawn on the screen until a different selection is made or BASIC is reset using a CLS RESET command.

Note: If you select one of the thicker line thicknesses, you may be limited to just the 'plain line' line-style.

3.8 The Windows menu

```
Show Results-1
Hide Results-1
*****
Show Results-2
Hide Results-2
*****
Show Edit
Hide Edit
*****
Show Dialogue
Hide Dialogue
```

The Window menu is used to open or close the windows on the monitor screen, and to make a particular window the active window.

The menu contains two options for each screen window – **Show window-name** and **Hide window-name**. Clicking on the **Show** option makes the chosen window the active window. If necessary, the window will also be opened and given the same size and position as it had when it was closed.

Clicking on the **Hide** option closes the window. This doesn't, of course, stop your program sending output to the virtual screen associated with the window: it just stops this information being displayed on the monitor.

3.9 The BASIC 2 menu

This is identical to the DESKTOP menu available while you are using the GEM Desktop, except that the information about the GEM Desktop has been replaced by information about the BASIC 2 program.

The Desk Accessories – Snapshot, the Calculator, the Clock and the Print Spooler – may all be used as described in Part II of this manual.

3.10 The Function keys

- F1** Marks the start of a section of program you want to copy, move or delete. If the start has already been marked, pressing **F1** marks the end of the section. The End marker can be either before or after the Start marker.
- F2** Stops marking a section of program. If you wish you can stop marking the section after just positioning one end. The section of program is left in its current position.
- F3** Inserts a copy of a marked section of the program at the cursor position. The original program segment is unaffected.
- F4** Moves a marked section of program, removing it from its current position and inserting it at the cursor position.
- F5** Removes a marked section of the program.
- F7** Makes the program resume at the point it was stopped.
- F9** Runs your current program.
- F10** Goes into the Editor to edit the current program. If you are already in the Editor, pressing **F10** leaves the Editor and returns you to the Dialogue window.

4. BASIC 2 COMMANDS

BASIC 2 is a very powerful version of the BASIC programming language. By using its commands, you can:

- carry out calculations involving a full range of arithmetic functions
- draw circles, boxes, ellipses and many other shapes in a range of styles and fill them in any one of a number of coloured patterns
- draw Turtle Graphics, ie. draw pictures by directing a 'turtle' around the screen
- manipulate lists and strings of characters
- control the size, position, etc. of windows on the screen
- manipulate your disk files from within your program
- access records by word-keys rather than sequentially or by record numbers

It is not possible to give a full description of every BASIC 2 command here. Instead, each section of this chapter covers a different aspect of BASIC 2, introducing the commands that you may use in this type of work. For a full description of the commands you will need to turn either to 'Locomotive BASIC 2 User Guide' (published by AMSTRAD) – particularly if you have never programmed in BASIC before – or to the 'BASIC 2 Technical Reference' (available from Locomotive Software).

If you have programmed in BASIC before, you may well be able to start writing BASIC 2 programs straight away. The names of a number of the commands used for arithmetic, program control and input/output will be very familiar, and they work in the way you expect.

These first programs could involve drawing boxes, pie charts etc. or turtle graphics. To enable you to build graphics into your programs from the start, Sections 4.4 and 4.5 also gives the basic syntax of BASIC 2's graphics commands. However, for the full details of these commands – for example, how to use your program instead of the menus to set such things as line styles, colours and fill patterns – you will still need to turn to either the BASIC 2 User Guide or the BASIC 2 Technical Reference.

4.1 Commands for manipulating data

BASIC 2 incorporates a full range of arithmetic functions and logical operators for use on both integers and floating point numbers, in addition to the standard arithmetic operators + (plus), - (minus), * (multiply), / (divide), \ (integer divide) and MOD.

COS, SIN and TAN provide the usual trigonometric functions, with ACOS, ASIN and ATAN (or ATN) giving the corresponding angle functions (arc-cosine, arc-sine and arc-tangent, respectively). Angles are usually expressed in radians but you can choose to express all angles in degrees by using an OPTION DEGREES command. The OPTION RADIANS command changes the program back to working in radians; the DEG function converts angles in radians to degrees; and the RAD function converts angles in degrees to radians.

The EXP function raises the value of e to a given power; LOG gives the logarithm of a number to the base e, ie. the number's natural logarithm. If you want a log to the base 10, rather than a log to the base e, this is provided by the LOG10 function. Other functions that manipulate numbers include:

- SQR which returns the square root of the number
- ABS which returns its absolute value
- SGN which returns the sign of the number
- FRAC which returns the fractional part of a number
- RND which returns a (pseudo)random number
- MIN and MAX which return the smallest and largest members of a list
- and the various functions for rounding a number to an integer - FIX, INT, ROUND

The logical operators built into BASIC 2 are: AND which tests whether two statements are true simultaneously; NOT which tests whether a statement is false; OR which tests whether one of a group of statements is true; and XOR which tests if one statement of a pair is true but not the other.

4.2 Program control

Program control falls into two main areas: creating, running and stopping a program; and directing how control should be passed from one section of the program to another as processing continues.

To create, run or stop a program, you would normally use the appropriate option in the Program menu but you can if you wish type the commands RUN and STOP in the Dialogue window.

STOP is like pressing Ctrl-C - it halts processing whatever stage the program has reached. The program can then be made to continue by selecting the Continue option (again from the Program menu) or typing the command CONT. If you don't want the program to be stopped in this way, you can use an OPTION RUN command.

To change the program you have just loaded or run, you either select the Edit option (from either the Program or the Edit menu) or type the command EDIT. This automatically transfers you from the Dialogue window to the Edit window. The SYSTEM command (or selecting the Quit option from the File menu) returns you to GEM.

Within the program, GOTO and GOSUB commands can be used to transfer control to different parts of the program, with RETURN commands directing control back at the end of a subroutine. To identify lines in the program you want to transfer control to, give these lines line numbers. In BASIC 2, you can make which part of the program is executed next depend on the current value of a variable by using the special ON GOTO and ON GOSUB commands.

IF commands may be used to ensure that certain sections of the program are only executed if some particular condition is met. If the condition is met, the THEN part of the IF statement will be chosen; if not, the program will process the ELSE part (if there is one) or go on to the next statement in the program.

BASIC 2 also supports three different types of loop, all of which can be nested: FOR...NEXT; WHILE...WEND and REPEAT...UNTIL. A FOR loop has a control variable which steps through a range of values - one per iteration - under a given end value is reached. The step can be positive or negative and you can specify its

size. NEXT marks the end of the loop. WHILE loops and REPEAT loops both repeat the instructions within the loop until a given condition becomes false. The WHILE loop tests for the condition before starting each cycle; the REPEAT loop tests for the condition at the end of each cycle.

The END command stops the program and returns to Direct Mode. The REM command (or the alternative, ') makes BASIC 2 ignore the rest of the line and so can be used to insert comments into your programs. Comments are very useful in making your programs more readable, both by spacing out the different sections of the program and by providing brief descriptions of what each section of program does.

4.3 Input and Output of data

The data processed by programs is either constant data, held in the programs in DATA statements and read in by READ statements, or information read in usually either from the keyboard or from a file already stored on disk.

The BASIC 2 commands for input are:

- INKEY\$ which reads single characters typed at the keyboard
- INPUT which takes a line of input, either from the keyboard or a file, and assigns the information to a list of variables (numeric and/or string)
- INPUT\$ which reads in a fixed number of characters typed at the keyboard
- LINE INPUT which takes a line of input and assigns it to a single string variable

To output data, it is PRINTed either to the Dialogue window, one of the Results screens or to a line printer. The standard form of PRINT lists the data in 'free format' either one after another with no spaces if the items in the PRINT statement are separated by semicolons, or starting at the next 'print zone' if the items are separated by commas. Print zones in BASIC 2 are initially every 15 characters, but this can be changed by selecting a different ZONE size.

You can control the format the data will have when it is printed by using one of the PRINT command options, the keyword USING followed by a format template. Other PRINT command options let you set, for example:

- the place on the screen where output will start
- the colour used for the characters
- the size and style of characters used to print the information
- the angle at which the information will be written - normal, up, down or upside-down

These special PRINT styles can, of course, be set through the menus for data output on the Default screen (Results-1 unless you change this). The PRINT options let you set these styles for output on other screens.

To send output to your printer, BASIC 2 has an LPRINT command - though you can also use a PRINT command if you direct BASIC 2 to send the data to your printer.

While the data is being processed, you can of course organise it by placing the data in arrays. DIM statements are used to declare the sizes of arrays you want and, if you wish, the number of the first element in the array. Later, if you want to find out what the numbers of the first and last elements are, you can use the BASIC 2 functions LOWER and UPPER.

4.4 Screen Graphics

One of the most attractive aspects of BASIC 2 is its ability to produce graphics – circles, boxes, ellipses, sections of circles and ellipses (eg. for drawing pie charts), and many other shapes. There are specific commands to help you draw each shape with names like BOX and CIRCLE. Add in the choice of colours, line-styles, fill patterns etc. etc. that are available and you can see that BASIC 2 could be used to produce very attractive and effective illustrations and charts.

The commands are listed below, together with the 'Form' of statement that will give you the shape you want on the Default screen (initially Results-1). You can readily enhance the pictures you produce by selecting colours, fill patterns etc. from the menus. The full BOX, CIRCLE etc. commands allow you to put these enhancements actually into the program.

Commands

- ARC** Draw an arc of a circle from (x1;y1) to (x2;y2).
ARC x1;y1,x2;y2,radius
- BOX** Draw a box, bottom lefthand corner at (x;y).
BOX x;y,width,height [FILL]
- CIRCLE** Draw a circle, centre at (x;y).
CIRCLE x;y,radius [FILL]
- ELLIPSE** Draw an ellipse, centre at (x;y).
ELLIPSE x;y,radius,aspect [FILL]
- ELLIPTICAL ARC** Draw an arc of an ellipse from (x1;y1) to (x2;y2).
ELLIPTICAL ARC x1;y1,x2;y2,radius,aspect
- ELLIPTICAL PIE** Draw a segment of an ellipse, centre at (x;y).
ELLIPTICAL PIE x;y,radius,aspect,start-angle,end-angle [FILL]
- LINE** Draw series of straight lines through a list of points.
LINE x;y[,x;y...]
- PIE** Draw a pie slice, point at (x;y).
PIE x;y,radius,start-angle,end-angle [FILL]
- PLOT** Plot a list of points (x;y).
PLOT x;y[,x;y...]
- SHAPE** Draw a polygon with (at least 3) vertices at points (x;y).
SHAPE x1;y1,x2;y2,x3;y3[,xn;yn...] [FILL]

4.5 Turtle Graphics

Turtle Graphics – that is, drawing pictures by directing a pointer known as a turtle to move around the screen – is very popular, particularly in teaching computing because it demonstrates very clearly how a computer works through a program instruction by instruction.

BASIC 2 includes a wide range of commands and functions that you can use for directing a turtle, as follows:

DISTANCE Give the distance of the point (x;y) from the turtle.

DISTANCE (x;y)

FD or **FORWARD** Move turtle forward, drawing a line unless MOVE is specified.

[MOVE] FORWARD *distance*

HEADING Give the current heading (angle) of the turtle.

HEADING

LEFT or **LT** Turn turtle left through a given angle.

LEFT *angle*

POINT Set the turtle to point in the given direction.

POINT *angle*

RIGHT or **RT** Turn turtle through an angle to its right (clockwise).

RIGHT *angle*

TOWARD Give the bearing of point (x,y) from the turtle.

TOWARD (x;y)

4.6 Advanced features of BASIC 2

Manipulating strings of characters

BASIC 2, like most BASICs, has functions like ASC to return the ASCII value of a character; CHR\$ to return the character with a given internal code; BIN\$ to convert a number into the equivalent string of binary digits; or HEX\$ to convert the number into the equivalent hexadecimal form.

It also contains a number of functions and commands that pick out or alter information in a string of characters. A particularly powerful feature is the `{start-character TO end-character}` syntax which enables you to pick substrings out of other strings. Other commands include:

- INSTR which searches for a short substring in a given string of characters
- LEFT\$ which returns the lefthand part of a given string.
- LEN which returns the length of the string.
- LOWER\$ which converts the string to lower case.
- LSET which sets the beginning of a string to another of a different length.
- MID\$ which replaces or returns part of a string.
- RIGHT\$ which returns the right hand part of the given string.
- RSET which sets the end of a string to another of a different length.
- UPPER\$ which converts a string to upper case.

Error trapping

When BASIC detects an error, its default action is to put up an error message and stop the program. However, BASIC 2 lets you respond within the program to the fact that an error has occurred by using the ON ERROR GOTO command. This lets you set which part of the program should be processed immediately after the error occurs. RESUME can be used to return to normal running after the error has been processed.

BASIC 2 also lets you find out what the error was (through the ERR and OSERR functions), and by using ERROR commands, you can generate your own error conditions that can be trapped and processed in the same way.

Screen handling

Because graphics is a major feature of BASIC 2, a number of the commands and functions either control or provide information on how and where pictures and text can be written on your various results screens.

There are far too many of these to cover all of them here, but to give you some idea of the scope:

GRAPHICS and SET define your base graphics and text styles. FONT\$, POINTSIZE return information about the style of characters being used. TEST tells you what colour a particular point on the screen is.

POS, VPOS, XPOS and YPOS tell you where the cursor is. XMOUSE, YMOUSE tell you where the mouse is. XPLACE and YPLACE, XSCROLL and YSCROLL tell you which part of the virtual screen is showing in the window.

SCREEN and USER SPACE define the size of a virtual screen and whether it is used for text or for graphics. WINDOW OPEN, WINDOW CLOSE make a window visible or invisible. WINDOW FULL, WINDOW SIZE control its size; WINDOW PLACE sets its position on the monitor; WINDOW SCROLL sets the part of the virtual screen that shows in the window.

XDEVICE and YDEVICE, XMETRES and YMETRES tell you about the size of the monitor screen. XACTUAL and YACTUAL, XWINDOW and YWINDOW give you the size of a window. XVIRTUAL and YVIRTUAL give you the size of a virtual screen. XCELL and YCELL, XPIXEL and YPIXEL give you the sizes of the screen's character cells and pixels.

Details of all these commands and functions are given in the Locomotive BASIC 2 User Guide.

File handling

BASIC 2 lets you manipulate disk files from within programs, not just to access data but also:

- to delete files you no longer need
- to rename files
- to change the current directory you are working with
- list a directory
- type simple text files

A number of the commands are identical to the equivalent operating system commands. Thus, BASIC 2 includes commands like CHDIR, DEL, DIR, ERASE, REN, and TYPE. These are supplemented by commands like DRIVE which sets the default disk drive and functions like EOF and LOF which look for the end of a file and tell you about the file's length.

Accessing records by word-keys

BASIC 2 lets you say which record you want in a file by giving a name rather than having to quote its record number. This powerful type of file access, known as Keyed Random Access, is very useful for databases from your phone list upwards. It is quite common on mainframe and minicomputers, but rare on microcomputers.

Commands like ADDKEY and ADDREC add new information into your keyed file; DELKEY deletes information that is no longer wanted. KEYSPEC lets you define the index that will hold all the word-keys you use. KEY, KEY\$, POSITION and POSITION\$ either set or tell you whereabouts in the index and in the file itself you are currently working.

How to construct and use keyed files is covered fully in the Locomotive BASIC 2 User Guide.

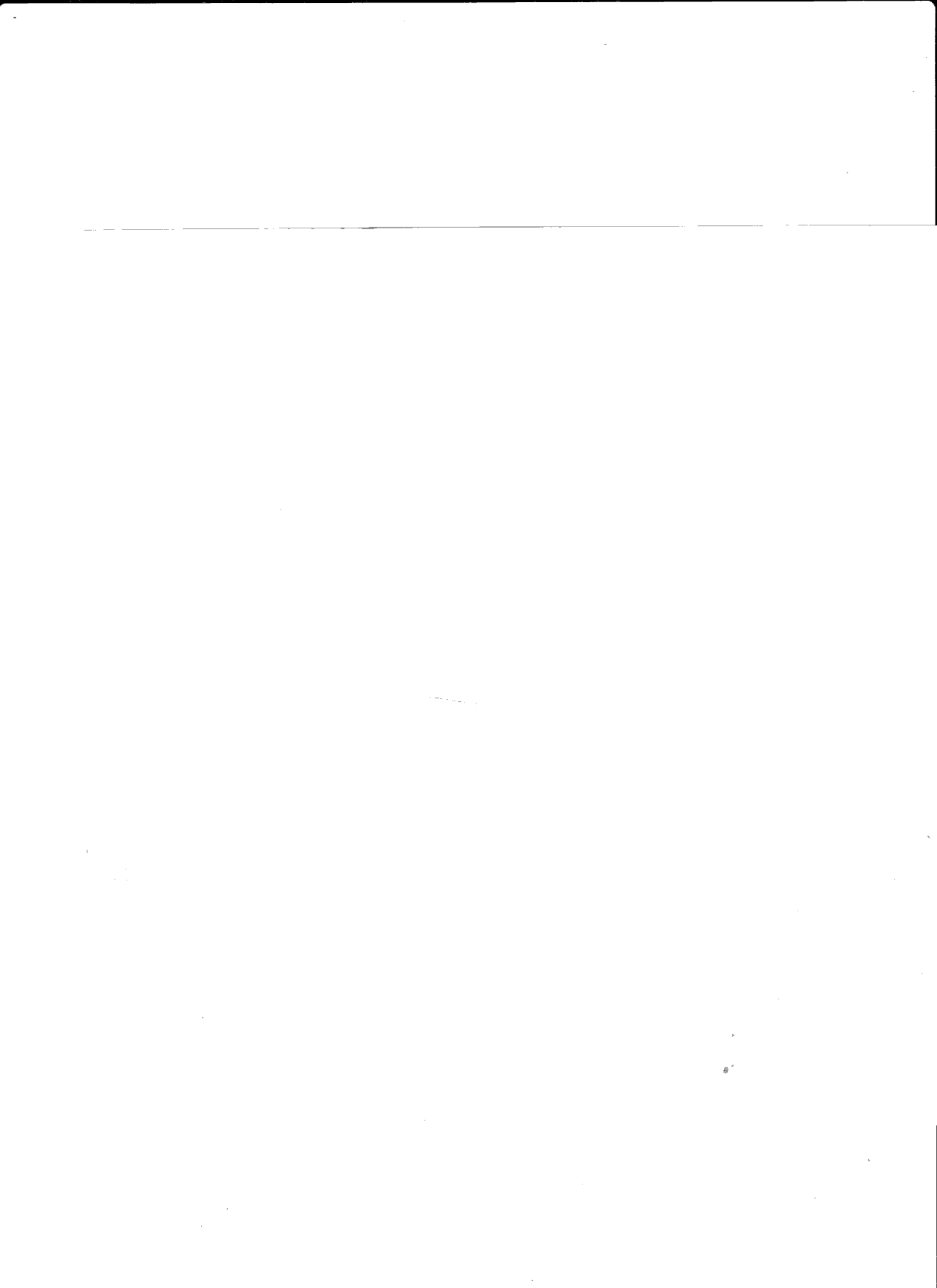

APPENDICES

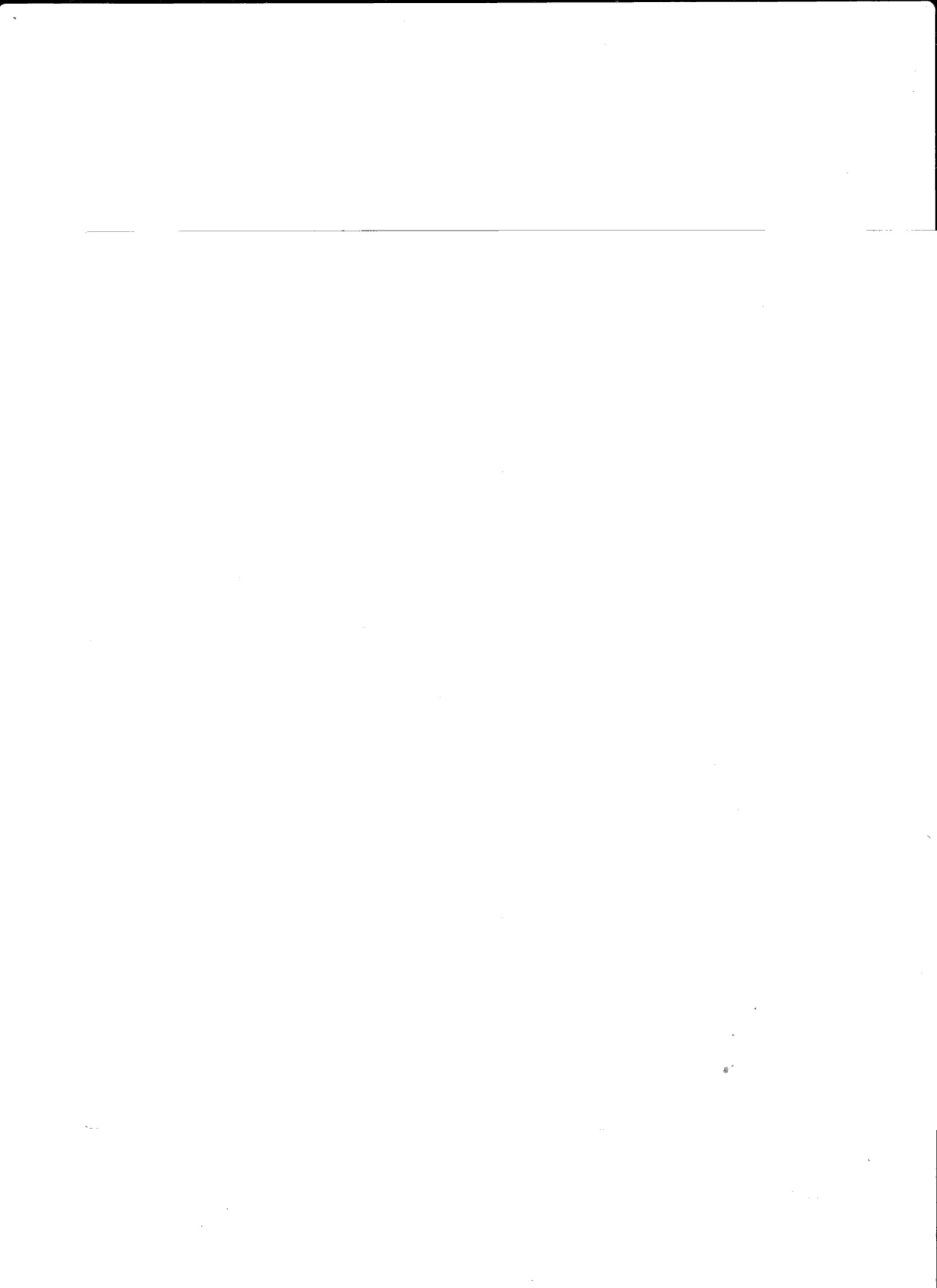

Appendix I: BUYING AND INSTALLING PROGRAMS

The AMSTRAD PC is supplied to you with 'system' software – the 'tools' needed to use your computer – but not with 'application' software – the programs you will need to carry out computational tasks. You will either have to write the programs you need yourself using, for example, Locomotive Software's BASIC 2 (on Disk 3 of your AMSTRAD PC disks) or you will have to buy programs from your computer dealer.

The sample files supplied with the AMSTRAD PC will be sufficient while you are learning to use the machine but you will probably soon need to select and buy commercial programs. This appendix provides a guide to selecting the programs to run on your PC and to avoiding potential pitfalls, by covering:

- **What makes a program suitable to run on your AMSTRAD PC**
- **Which operating system to run the program under**
- **How to go about installing a program on your machine**
- **Creating disks for particular programs, for example GEM Paint or GEM Draw**
- **Making programs convenient to use**
- **Using the mouse with your program**

1.1 Suitable programs

The AMSTRAD PC's compatibility with many other 16-bit micros means you can choose from a wide range of programs bought 'off the shelf' from your computer dealer. Its compatibility with the IBM PC and PC compatibles means you can use programs written for machines running the PC-DOS operating system. These could be computer games, accountants' spreadsheets, word processing programs or project planners.

Many of these programs will run perfectly on the AMSTRAD PC. Other programs will run but won't always produce the results you expect. They may appear not to control the screen properly or they may not respond correctly to the keyboard. Such programs will need to be 'installed' or 'configured' for your PC display type and/or for the peripherals (printers etc.) you have as part of your PC system. How to go about installing a program is described in Section I.3 below.

Programs for the AMSTRAD PC should be

- **Written to run under the PC-DOS or MS-DOS operating system**
And
- **Supplied on 5¼ inch double-sided, double-density, 48 tpi floppy disks**

If possible, choose a program that works with the GEM software because this will have the program options readily accessible through menus. You will just need to point on the screen at what you want.

Your dealer will be able to tell you whether a suitable version of the software you want to use exists or if it will need to be installed. Installing a program is a straightforward task, particularly if it is supplied with a special installation program, but it may require detailed background knowledge.

A large amount of software won't need to be installed on your PC.

Avoid, unless there is no other option, programs that have been written specifically for a computer other than the IBM PC or the AMSTRAD PC. Such software will probably need to be modified before it can be run on your PC and this may not be possible without specialised help. Check with your dealer that this is not the case.

Note: You will often find BASIC programs on sale alongside DOS programs and CP/M programs. These can be used on your AMSTRAD PC when it is running **both** the BASIC language which the program was written for and the operating system the BASIC language was designed to be used with.

The BASIC program may well work with Locomotive BASIC 2, the GEM-based BASIC language supplied on Disk 3 of your AMSTRAD PC disks. However, it may require either a particular BASIC or a Microsoft-compatible BASIC, in which case you will also need to acquire a copy of that BASIC in a version that runs under either MS-DOS or PC-DOS. For example, you can run BASIC programs originally developed for the AMSTRAD PCW machines by running the DOS version of Mallard BASIC on your AMSTRAD PC. (Programs developed using AMSTRAD BASIC on the CPC machines will, however, need to be converted.)

Note: IBM Personal Computer BASIC won't run. It only runs on IBM PCs.

1.2 Selecting which operating system to use

Alongside choosing an application program, you need to select which system software to use when running the program. Some versions of programs are supplied on disk together with appropriate operating system software: these are known as Turnkey versions of the programs, because they let you just turn your machine on and use the programs. (We describe how to make Turnkey versions of the programs you buy in Section I.5, below.)

The remainder require you to use one of your PC's Startup disks to load the necessary system software into your machine before you run the program.

The AMSTRAD PC is supplied with two different Startup disks:

- a GEM Startup disk
- an MS-DOS Startup disk

In addition, you can use a Startup disk for any other 8086 compatible operating

system, for example PC-DOS, CP/M-86 or DOS-Plus (provided it is a suitably-formatted 5¼-inch floppy disk).

Which Startup disk (and hence which system software) you use depends on what programs you want to run:

- If you want to run a program that works with the GEM software, then you use the GEM Startup disk after the MS-DOS Startup disk
- If you want to run an MS-DOS or a PC-DOS program, then you are likely to use the MS-DOS Startup disk

1.3 First steps

1. Copy the disks you have just bought

The disks you have just bought are both valuable and vulnerable to accidents. You should therefore always work with copies of disks rather than with the original disks, if this is at all possible.

So the very first thing to do is to make copies of these disks. The instructions are given in Part I, Sections 6.1 and 7.1. Then store away the original disks as your Master copies for use only to make new copies from in case of accidents.

Note: Some programs are copy protected – you can't copy these by the standard method. However, you may be able to copy all but a part – how to do this will be described in the program's own user guide.

2. Install the programs, if this is necessary.

A program may need installing if:

- **your version of the program isn't specifically marked as being for the AMSTRAD PC1640 with your monitor. Refer to Appendix IV if you are in any doubt about the compatibility of your monitor**
- **you have added to your AMSTRAD PC system in any way, eg. by adding a printer**

Your dealer should be able to tell you whether you will need to install any program you buy, though you can also discover whether a program needs to be installed by running it. If, for example, it appears not to control the screen properly or text sent to the printer doesn't come out right, then you need to install the program.

If an installation program is provided with the software, you may well be able to install the program yourself. Software suppliers typically include a fairly detailed set of instructions with any software package that needs installing and we strongly advise you to read this.

Note that your dealer should be able to help you with any information required to install your applications if they do not already include explicit instructions for Hard Disk operation. Some programs that incorporate sophisticated copy-protection may not be (easily) transferable to Hard Disk. DOS programs may also be run in the floppy disk drive.

Do be careful to check whether the installation instructions were written for the AMSTRAD PC or for some other computer, for instance the IBM PC. If it was written for the IBM PC, then information about the keyboard and the screen will be correct but instructions about where to find particular external commands on the System disks will probably be wrong. You may also find you have an .EXE file where the instructions refer to a .COM file or vice versa: in this case, use the .EXE file as if it were the .COM file referred to.

If there is no installation program, you will probably need specialised help.

The job of an installation program is to set some parameters within the main program according to information you supply about how the AMSTRAD PC works. The information about the AMSTRAD PC you might need when you run an installation program is given in Appendix IV.

However, the form in which this information will be requested varies from application program to application program. Sometimes you will be asked to select from a range of standard options (which options to choose are detailed in Appendix IV), but at other times to press particular keys or to type in the codes given in Appendix IV.

If you run into any problems, consult your dealer.

1.4 Creating disks geared towards a particular program

The way to make a program most straightforward to use is to put the copy of the program you use daily on a disk with copies of support programs it calls on (for example, MS-DOS external commands) but nothing else. Any space left over on the disk can be used for the program's data files, if it doesn't create or use too many of these, but otherwise it is best left blank with separate disks used to store the program's data.

Mixing up different programs on the same disk may reduce the number of disks you need to buy but it also causes a lot of hassle! You really are much better off with a separate BASIC disk, GEM Paint disk, Wordstar disk, etc. etc. (Remember if you decide to use a new blank disk for data storage to format it first - see Part I, Sections 6.5 and 7.5.)

The problem then with a new program is to what to put alongside the main program on the disk.

Your best course of action is to spend some time studying the program's user guide and discovering from this which programs and external commands the main program needs to have access to. The user guide will often tell you precisely which files you need to have on the program disk.

If you have room on the disk or if you are able to divide the program files among a number of disks, you can also add generally useful external commands such as the disk copier program. However, in practice, you are likely to have to work out which files are essential and which are something of a luxury (for example, will you really need OUTPUT.APP?) and then experiment until you achieve the best combination in the circumstances.

In some cases, the user guide may not explain all the subtleties involved. The description of anything using the GEM software or a GEM accessory such as GEM OUTPUT might well assume that you know that you need not only the OUTPUT.APP

file, but also OUTPUT.RSC, DEFAULT.OPT, suitable Font files, the right Printer driver for your printer, the right Metafile, etc. etc.

What each program needs is specific to that program so it is not possible to give general advice. But to help, Appendix IX is a table listing all the files supplied on your AMSTRAD PC disks explaining what each file is used for. The table also shows which files you will need to have available when you want to:

- **Run any programs under MS-DOS**
- **Use any GEM software**
- **Use the GEM Desktop**
- **Create pictures and display these using a GEM program such as GEM Paint**
- **Print out pictures on a printer**
- **Run BASIC 2 and BASIC 2 programs**

Another possible source of advice is, of course, the computer dealer you bought the program from or a friend or colleague who is already using the program. But don't be afraid to try out a combination of files that seems to be appropriate from what you have read. It is unlikely to take you more than a few goes to get the program working and there is a fair chance you will get it right first time!

1.5 Making a DOS program convenient to use

A DOS program becomes particularly convenient to use if you put into a special Batch file all the instructions needed:

- to set up the search path(s) that make the program files and data files appear as if in the default directory (see Part III, Section 4.2)
- to set up your PC's input and output devices in the right way for the program (see Part III, Section 7.1 or Part IV, Section 5.1)
- to run the program itself
- to carry out any supplementary actions, such as making back-up copies of files that the program has created and deleting any files that you don't want to keep (Batch files are described in Part III, Section 4.4.)

Note: The best place for your program files is in a dedicated folder on your Hard Disk (if fitted).

You can set up such a Batch file either from scratch or by editing an existing Batch file. In either case, the AMSTRAD PC's text editor RPED is probably the best tool to use: RPED is particularly suited to creating and changing short files such as Batch files. (How to use RPED is described in Part I, Sections 6.7 and 7.7.)

By the way, always be careful not to give your Batch file the same filename as any other program file in the same directory (the filename is the part of the file's name before the full stop), because MS-DOS will always run the program in preference to the Batch file. So if, for example, you set up a Batch file to run a program stored in a

file called SPREAD.COM, don't call your Batch file SPREAD.BAT. Call it something like MYSPREAD.BAT instead.

Once you have set up such a Batch file, the only command line you need to type in order to do all this work is one made up of the filename of the Batch file and any parameters the Batch file requires.

A special way of making a program convenient to use is to make it run automatically immediately after the operating system software has loaded. Such a program is known as a Turnkey program – from the idea of just turning on and running. It is particularly useful if you want other people, who don't necessarily understand how to run a program on your PC, to use the software you have bought. You need only to tell them to turn the PC on, to follow the instructions on the screen (in particular, to insert the disk you have given them when they see the message 'Insert a SYSTEM disk') and to follow the instructions in the program's own user guide.

In order to make a program operate in this way you have to:

1 Prepare a new blank disk and store the operating system software on it.

Under MS-DOS, this means, to start with, formatting the disk using the /S option of the FORMAT command (see Part III, Section 6.1). It also means copying the ASSIGN.SYS and CONFIG.SYS files from your MS-DOS Startup disk (Disk 1) to the new disk, plus the RAMDRIVE.SYS, ANSL.SYS, KEYBUK.EXE and MOUSE.COM files if your current CONFIG.SYS or AUTOEXEC.BAT call on these files.

2 Copy the files from your program disk onto this disk.

3 Edit your Batch file to run the program so that it includes the commands from your current AUTOEXEC.BAT file that you will need while running the program.

If you don't use a Batch file to run your program, copy the AUTOEXEC.BAT file from your Startup disk to the Root directory on your new disk. Then edit it so that the last line is the command line you use to run your program.

4 Change the name of the Batch file to AUTOEXEC.BAT and store it the Root directory of your program disk.



You can then use this disk in the Startup procedure as a Startup disk. Test that the software now works as Turnkey Software by inserting the disk in Drive A of your PC and holding down the **Ctrl** and **Alt** keys while pressing the **Del** key. If all is well, the welcome message of your purchased software will now be displayed on the screen at the end of the Startup procedure.

1.6 Using the mouse or a joystick with commercial programs

You probably think that the mouse on your PC is only of use while you are using the GEM software. In fact, moving the mouse and clicking its buttons sends codes to your PC all the time the mouse is attached to your machine and other programs – not just GEM programs – can be designed to make use of these codes. Similarly, programs can be designed to make use of codes generated by using a joystick plugged into your PC.

There are two ways in which programs can use these codes:

- **they can either use them to drive special features of the program** in which case this will be fully described in the program's user guide
- **or they can use movements of the mouse or the joystick to move the cursor on the screen and interpret clicks of the buttons as particular keystrokes on the keyboard**

In the second case, the keystrokes the program 'sees' will be the ones set up in the Battery-backed RAM (see Appendix II). Normally, clicking the lefthand button on the mouse is equivalent to pressing  and pressing the righthand button is equivalent to pressing . The joystick fire buttons are initially set to a 'dummy' code (which is interpreted as 'Ignore me').

Programs can only use the mouse if the mouse driver (MOUSE.COM) has been loaded. MOUSE.COM is stored on Disk 1 and the instruction to load it is included in the AUTOEXEC.BAT file supplied on that disk.

When used within a GEM application or a DOS application run by clicking from the GEM Desktop (except when installed as a Full Memory Application) the mouse is set up to have one button – the lefthand button – whilst the righthand button simulates a Shift key. This is particularly useful for 'Shift Clicking'. At all other times the mouse is set up to have two buttons.

If you don't want to make use of the mouse of your program and there is a risk that accidental movements of the mouse will upset your work, you can either unplug the mouse or you can disable it by setting the Mouse Movement Factor recorded in the Battery-backed RAM to 0. One way this can be done is by running the NVR program (see Appendix II) before you run your program.

WARNING: Software that requires an IBM Analog Joystick will not be controlled by an industry standard joystick such as the AMSTRAD joystick.

Postscript

Your software is now ready for use and instructions on how to run it are given in Part I, Sections 5.4 and 5.5.

If your software works with GEM and you want to run it from the GEM Desktop, a further stage of preparation may be needed which records information about the program within the GEM Desktop. This information is already recorded for a number of popular programs. The process, which is called 'Configuring an application', is described in Part II, Section 3.2.

Appendix II: SETTING UP THE BATTERY-BACKED RAM

The Battery-backed RAM is a special area of the AMSTRAD PC's memory which is used for storing information that needs to be carried over from one time you use your PC to another – for example, the setting of the date and time clock and details of the communications links you have attached to your PC. This section of the memory is constantly powered from batteries to ensure this information isn't lost.

The details held in the Battery-backed RAM are:

- the date and the time
- the internal code produced when the **Enter** key is pressed
- the internal code produced when the **Del>** key is pressed
- the internal codes produced by the two joystick fire buttons
- the internal codes produced by the mouse buttons when your PC is being used for text (rather than graphics)
- the relation between how far you move the mouse and how far the pointer moves on the screen when your PC is being used for text
- the mode the screen initially works in ("READ ONLY" in PC1640)
- the initial background and text colours (not applicable to PC MD)
- the amount of your PC's memory set aside to work as an additional disk – the RAM disk
- the way the Serial Interface is set up

The AMSTRAD PC is supplied with appropriate values for all these details except the date and the time. But some programs may need you to change these settings. To do this, you run the NVR program. This is in the Root directory of your GEM Desktop disk (Disk 3). How to run this program is described below. To set the date and the time, you either set the GEM Desktop clock (see Part II, Section 6.1) or you use the DOS DATE and TIME commands (see Part III, Section 7.3).

The final stage of using the NVR program is to write all the settings you have made to the battery-backed area of your PC's RAM. This ensures that the values you have selected for these parameters will be remembered even when your PC is switched off. You don't need to reset these values every time you use your PC. However, you will need to reset them after you replace the batteries because these go flat. (The last section of this appendix describes replacing the batteries.)

II.1 The supplied settings

Parameter



Enter key

Del>

Supplied setting

duplicates **←** key

deletes the character under the cursor (**^G**)

Joystick fire button 1	dummy code (&HFFFF - 'Ignore me')
Joystick file button 2	dummy code (&HFFFF - 'Ignore me')
Lefthand mouse button	 key
Righthand mouse button	 key
Mouse movement scaling	10 internal mouse movement clicks sideways (x-direction)=1 cursor key; 10 internal clicks forwards or backwards (y-direction)=1 cursor key (possible range 0...255)
Startup screen mode	80-column colour (other options: 40-column colour; 80-column monochrome if a monochrome graphics adapter has been fitted)
Startup background colour	black (options black, blue, green, cyan, red, magenta, yellow (brown), white in colour; eight different intensities on a monochrome screen)
Startup foreground colour	white (options black, blue, green, cyan, red, magenta, yellow (brown), white in colour - normal intensity or 'highlighted'; sixteen different intensities on a monochrome screen)
Size of the RAM disk	Initially zero, but when the GEM software is loaded from floppy disk, it will automatically be set to 34K if its size was zero. (Possible range 0...510.) Set to zero when the GEM software is loaded from Hard Disk.
RS232 (Serial Interface) parameters	
Standard	Transmission rate 9600 baud (possible values: 110, 150, 300, 600, 1200, 2400, 4800, 9600) Parity NONE (other options ODD , EVEN) Number of data bits 8 (other option 7) Number of stop bits 1 (other option 2)
Optional	Transmission rate 9600 baud (possible values: 110, 150, 300, 600, 1200, 2400, 4800, 9600) Parity NONE (other options ODD , EVEN) Number of data bits 8 (other option 7) Number of stop bits 1 (other option 2)
Flow control (hardware handshaking between two computers)	OFF (options ON or OFF)

II.2 To change the settings

- 1 **With your Desktop disk (Disk 3) in a floppy disk drive (or the Root directory of your Hard Disk), select the NVR.EXE program icon in the Root directory of your Desktop disk by moving the pointer to the icon and double clicking the lefthand mouse button.**

If you are using MS-DOS commands, make the drive holding your Desktop disk the default drive and type:

`\NVR `

The following display should appear on your screen. This is the Main Menu of the NVR program, together with instructions on how to select the option you require.



If you like, just follow the instructions on the screen, but we also go through the sort of steps you should take below.

- 2 Use the key and the key (or the Space bar –) to move the highlighting to the first parameter you want to change. Then press the key.

Up on the screen should come a display with the same title as the parameter you chose. If you see another display, press the key to take you back to the Main Menu and then try again.

The way to make the settings you require varies according to the parameters you want to set. The common factors are that you use the and keys to move the highlighting to the option you require and press the key to select this option. Again the screen should give you all the instructions you need but we give further details below.

- 3 Move the highlighting in the Main Menu to the next parameter you want to change and then set this as in Instruction 2 above.

The option highlighted when you return to the Main Menu is the last option you selected. Use the key and the key (or the Space bar) to move to the next option you want to select. Note: If you keep on pressing the key, the highlighting will cycle round to the bottom of the list again. Similarly, if you keep pressing the key or the Space bar, the highlighting will cycle round to the top of the list again.

- 4 Finally, move the highlighting to the Exit Menu option and press .

This gives you three options:

Save these alterations to RAM

saves the parameters you have set for use in future when you switch on or reset AMSTRAD PC. The screen, however, will be set to the initial screen colours you have just set when you select Exit to DOS (see below). *

the highlighted version of the colour. You are then automatically returned to the first screen, so that you can go on to change the other colour.

If you decide against changing this colour, but you still want to change the other colour, move the highlighting back to original colour before pressing **[←]**. If you don't want to change the other colour, press **[Esc]**: this returns you to the Main Menu.

When you have set the colours you require, press **[Esc]** to take you back to the Main Menu.

Note: NVR won't let you set the foreground and the background to the same colour. If you try to set, say, the background to the same colour as the foreground, NVR will automatically return the background to its old colour. As a result, if the current foreground colour is the one you have chosen for the new background colour (say), **change the foreground colour to a new colour first before setting the background colour.**

Initial RS232 Standard and Optional parameters

These parameters control how data is handled through the Serial Interface.

- 1 Move the highlighting to the parameter you want to change and press the **[←]** key.**

This cycles the parameter through the possible options – so keep pressing the **[←]** key until the option you want is displayed.

- 2 Then move the highlighting on to the next parameter you want to set, press the **[←]** key until this is set to the correct option, and so on.**

When you have set the parameters you require, press **[Esc]** to take you back to the Main Menu.

11.3 Changing the batteries

The batteries powering the Battery-Backed RAM will need to be replaced from time to time. You have two options:

– **either** to wait for your PC to report that the batteries have gone flat before changing them

– **or** to change them on a regular basis, say once a year, before they go flat.

The first option is more economical on batteries – but it means that you will have to go through the procedure of setting the clock and setting the other details held in the Battery-backed RAM each time you have to change batteries. The second option allows you to change the batteries without losing the information and this is the one we recommend: you should not need to change the batteries more often than about once a year, but it does depend on how much time your PC spends idle.

The procedure in either case is as follows: it should be carried out either before you switch your PC on or after you have finished working with your PC and have switched off.

- 1 Start with the PC's mains plug out of the supply socket.**
- 2 Lift up the Display so that its base comes out of the recess in the top of**

the System Unit and then put it down to the righthand side of the System Unit.

Important: You must not move the Display in this way with the power connected to your PC.

It should be possible to move the Display without disconnecting the DC cable and the VDU cable that run between the Display and the System Unit (see Part I, Chapter 2). But, if necessary, unplug these two cables before you move the Display and then reconnect them once you have put the Display down to the righthand side of the System Unit.

3 Plug the PC into the mains supply and switch it on by pressing the Power switch on the back of the Display.

This provides power to your whole system, ensuring that none of the information stored in the RAM is lost while you change the batteries.

4 Take the four batteries out of the battery compartment and throw them away.

5 Replace these batteries with four new AA batteries.

Slot the four AA batteries into the battery compartment on the top of the System Unit as shown below. Check that you have each battery the right way round, with its positive (+) end over the plus sign inside the battery housing.

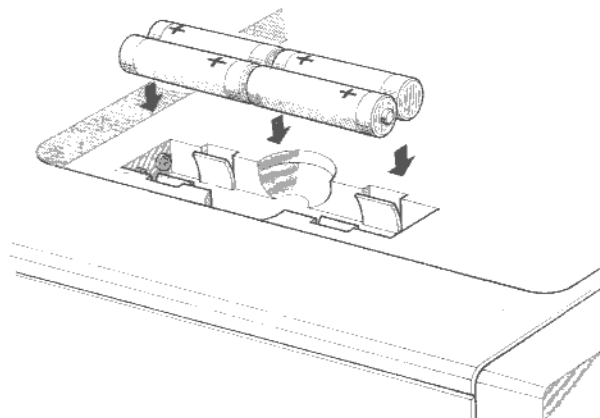

6 Hold down **Ctrl and **Alt** and press **Del**, and wait until the 'AMSTRAD PC 640K' message appears.**

7 Switch off by pressing the Power switch on the back of the Monitor and then unplug your machine from the mains supply.

8 Lift up the Display and place it back on the top of the System Unit, with its base fitted into the recess in the top of this unit.

Important: You must not move the Display in this way with the power connected to your PC.

Again, it should be possible to move the Display without disconnecting the DC cable and the VDU cable that run between the Display and the System Unit.

Your PC is now ready once again for normal use.

Appendix III: THE AMSTRAD PC CHARACTER SETS

Two main character sets are used on the AMSTRAD PC:

- 1 The standard character set – the System Font – used when the PC is running GEM software**
- 2 A separate character set that is used when your PC is set up to accept MS-DOS command lines**

Also supplied are a number of special fonts for use with GEM software. These give essentially the same characters as the System Font but the style of the characters is different and they are available in a range of sizes. The fonts can be used in among graphics on the screen or in pictures sent to your printer.

Overleaf is a table giving all the characters available, together with the keys you need to press to put each character onto the screen or into a file. In each character set, there are a total of 254 different characters.

The characters are listed in the order of their internal code, that is the 8-bit number that the PC interprets as the character you want to display. (Both character sets are based on 8-bit internal codes: that is how 254 different characters can be displayed.)

An internal code is always written either as a Decimal number or as a Hexadecimal number: the table gives both. Hexadecimal numbers are numbers to the base 16. When a character code is represented as a Hexadecimal number, it is normally written as **&H**, followed by a two-character number. The two-character number is actual hexadecimal number. These characters can be one of the digits 0...9 or one of the letters A...F.

Sections III.1 and III.2 below explain how to discover from this table both the key or keys to press to get the character you want and the internal code of any character. Section III.3 gives brief details of the special fonts on the AMSTRAD PC.

Not all programs have been written for an 8-bit character set: many have been written for the older 7-bit character set that only gave a range of 127 different characters. You can always tell if you are using the 'wrong' character set because every so often what the program has written on your screen will appear to be rubbish.

A related problem is how to use your PC like the equivalent French machine, say – typing in, displaying on screen and printing out accented characters, etc. in much the same way as you would if you were using a French PC. Each country has its own style of keyboard layout because of the different requirements of the language spoken there.

All of the 256 characters overleaf are available when using the internal graphics adapter of your PC in any high resolution (8*14 or 9*14) Mode or in low resolution (8*8) Text Mode. There are four international variants which are obtained by switch settings. The differences between each character set are defined in the Amstrad PC1640 Technical Reference Manual (soft 50016). These switch settings do not affect the language of any messages displayed on your screen or the characters sent to, or used by, your printer.

Your system disks do not contain any software commands to redefine any of these characters, even in graphics screen modes (eg GRAFTABL will not have any effect); although that may be achieved by certain specially written applications programs. Indeed some applications programs, such as word processors that operate with graphics characters, will provide their own graphics character sets despite the settings below.

For strict compatibility (16K of EGA Firmware ROM in the PC1640 address space) switch 9 should be turned off. In this case it is only possible to have an English character set. Normally (when 32K of EGA Firmware ROM is acceptable), switch 9 can be turned on enabling switches 6 and 7 to select the variant of the character set.

Switch 10 (see Appendix 4) disables the internal graphics adapter and all characters are then formed by the external graphics adapter, which is fitted in an expansion slot.

Characters produced by second(ary) graphics adapters, fitted in an expansion slot, are also formed by that graphics adapter and are not affected by the switch settings below.

Sw 6	Sw 7	Sw 9	Sw 10	
off	off	on	off	Danish
on	off	on	off	Portuguese
off	on	on	off	Greek
on	on	on	off	English
x	x	off	off	English
†	†	x	on	(defined by external graphics adapter)

x don't care

† the meaning of this switch now defined in Appendix 4.

>**GRAFTABL**> Low resolution characters in Graphics Modes of all adapters (both internal and fitted in an expansion slot) are defined by a combination of the Firmware ROMS (0-127) and the GRAFTABL utility (128-255). Each country is provided with a GRAFTABL utility suitable for that country. The GRAFTABL utility contains Sans-Serif style characters, matching the internal graphics 8*8 character set.

III.1 To find the key that produces a particular character

DEC		0	16	32	48	64	80	96	112
HEX		0	1	2	3	4	5	6	7
0	0	BLANK	▶ 16	BLANK SPACE	∅	Ⓐ	P	' 96	p
1	1	↑ ☺ 1	◀ 17	!	1	A	Q	a	q
2	2	↓ ● ◀ ▶ ↑ 2	↕ 18	"	2	B	R	b	r
3	3	→ ♥ ■ !! 3	¶ 19	#	3	C	S	c	s
4	4	← ♦ ¶ 4	§ 20	\$	4	D	T	d	t
5	5	■ ♣ § 5	§ 21	%	5	E	U	e	u
6	6	⌘ ♣ ↕ - 6	↕ - 22	&	6	F	V	f	v
7	7	♦ • ↕ 7	↕ 23	'	7	G	W	g	w
8	8	✓ ● ↕ DEL ← 8	↑ 24	(8	H	X	h	x
9	9	⊙ ○ ↕ ↔ 9	↓ 25)	9	I	Y	i	y
10	A	🔔 ○ → 10	→ 26	*	:	J	Z	j	z
11	B	🎵 ♂ ← 11	← 27	+	;	K	[k	{
12	C	▲ ♀ ↙ 12	↙ 28	,	<	L	\	l	
13	D	▼ 🎵 ↔ ↙ 13	↔ 29	-	=	M]	m	}
14	E	▶ 🎵 ▲ 14	▲ 30	.	>	N	^	n	~
15	F	◀ ⚙ ▼ 15	▼ 31	/	?	O	_	o	△ 127

DEC		128	144	160	176	192	208	224	240
HEX		8	9	A	B	C	D	E	F
0	0	Ç	É	á	ã	ij		α	≡
		128	144	160	176	192	208	224	240
1	1	ü	æ	í	ö	IJ		β	±
		129	145	161	177	193	209	225	241
2	2	é	Æ	ó	¥			Γ	≥
		130	146	162	178	194	210	226	242
3	3	â	ô	ú	ç			π	≤
		131	147	163	179	195	211	227	243
4	4	ä	ö	ñ	œ			Σ	∫
		132	148	164	180	196	212	228	244
5	5	à	ò	Ñ	œ			σ	∫
		133	149	165	181	197	213	229	245
6	6	ã	û	à	À			μ	÷
		134	150	166	182	198	214	230	246
7	7	ç	ù	ó	Ä			τ	≈
		135	151	167	183	199	215	231	247
8	8	ê	ÿ	¿	Ö			ϕ	°
		136	152	168	184	200	216	232	248
9	9	ë	Ö	∩	•			θ	•
		137	153	169	185	201	217	233	249
10	A	è	Û	∩	•			Ω	•
		138	154	170	186	202	218	234	250
11	B	ï	ø	ç	½	+		δ	√
		139	155	171	187	203	219	235	251
12	C	î	£	¼	♀			∞	∩
		140	172	188	204	220	236	252	
13	D	ì	ø	¥	ì	©		φ	²
		141	157	173	189	205	221	237	253
14	E	Ä	ℙ	<<	®			€	∩
		142	158	174	190	206	222	238	254
15	F	À	f	>>	™			∩	BLANK
		143	159	175	191	207	223	239	

Hold down
[ALT] plus
say 240 on
numeric keys
≡

1 Find where the character is represented on the table.

Where the entry in the table is subdivided into three boxes, remember to look at the top lefthand box if you are using the GEM software and at the top righthand box if you are using MS-DOS command lines.

2 Find the key.

The key is given in the bottom section of the table entry. Where the table entry is not subdivided into boxes, just press the key on the keyboard that is marked with

the character you want (while holding down the $\square \diamond$ key if you want either an upper case letter or the upper character written on the keytop).

If the bottom box contains a number in a box, hold down the $\square \text{Alt}$ key and type the number using the keys of the keypad.

III.2 To find the internal code for a particular character

1 Find where the character is represented on the table.

Where the entry in the table is subdivided into three boxes, remember to look at the top lefthand box if you are using the GEM software and at the top righthand box if you are using MS-DOS command lines.

2 Find the internal code by adding together the appropriate number at the top of the column containing the character and the appropriate number at the beginning of its row.

If you want the internal code as a decimal number, add the outer pair of numbers. For example, the 'decimal' internal code for the character 'K' is 64 + 11, ie. 75.

If you want the internal code as a hexadecimal number, add the inner pair of numbers by substituting the second character of the hexadecimal number at the top of the column by the character at the beginning of the row. For example, the 'hexadecimal' internal code for the character 'K' is 40 + B, ie. 4B.

Note: The character sets given here are full 8-bit character sets. The section of the table on the lefthand page gives the characters that are available when a 7-bit character set is being used.

III.3 The special fonts

The fonts supplied with the AMSTRAD PC are in two families – Swiss and Dutch – and are provided in a number of point sizes as follows (a point is a measure of the height of a character):

Swiss	Printer		7, 10, 14, (20, 28) point
	Screen	CD	10, 14, 18, (20, 28, 36) point
		ECD, MD	7, 10, 14, 18, 36, (20, 28, 72) point
Dutch	Printer		7, 10, 14, (20, 28) point
	Screen	CD	10, 14, 18, (20, 28, 36) point
		ECD, MD	7, 10, 14, 18, 36, (20, 28, 72) point

The sizes in parentheses are obtained by doubling a smaller font. Other styles and sizes are available from Digital Research.

All these sizes are available both on your screen while you are using a GEM program such as Locomotive BASIC 2 and when you print out a picture prepared using GEM software. (The screen fonts and the printer fonts are in fact held in different files – the screen fonts in files with names like AMSLSS10.FNT and the printer fonts in files with names like EPSHSS10.FNT.)

When you use some of the more advanced features of BASIC 2, as described in the Locomotive BASIC 2 User Guide or the BASIC 2 Technical Reference, you will find yourself needing to refer to the different styles of font by number rather than by name. The System Font is always Font 1, but the numbers for the others depend on the order the styles are listed in the ASSIGN.SYS file. If you don't change this file, the Swiss style is Font 2 and the Dutch style is Font 3.

Appendix IV: INTERFACING TO AMSTRAD PC HARDWARE

This appendix lists some fundamental information about the AMSTRAD PC. The first section describes the various display selections available and how to set up your PC to operate with a wide range of software. It also lists the codes to which the display responds; the second section lists the codes that the various keys on the keyboard generate. These are the codes used by programs to display information on the screen and to interpret what you type at the keyboard correctly. Tabulated at the end of the appendix are the device names used by MS-DOS for the input and output devices of your PC.

For most users, the information given here is only of use when you are installing a new program. The installation program you run will sometimes ask you to type in details of the code that produces a particular effect, such as clearing the screen, and you can find that code in the tables below. More often, though, it will ask you to press a particular key so that it can learn that way what the code is or it will ask you which standard system your PC emulates. This is also detailed below.

These codes are also of interest to programmers developing programs for the AMSTRAD PC, whether in assembler or in BASIC. The screen control codes detailed here can be used in PRINT statements to produce particular effects on the screen as your BASIC programming guide is certain to explain. NOTE: You won't be able to use these codes in BASIC 2 because it works in a graphics environment, rather than a text environment.

IV.1 The display

Your PC1640 is really three computers in one. The system unit is capable of operating with either the PC MD (Monochrome), PC CD (Colour) or PC ECD (Enhanced Colour) displays. However, the best way to fully understand the ways in which your PC operates, and the implications for software you require to use, is to understand the evolution of the many graphics standards available.

You can refer immediately to the table of switch settings in Section IV.1.2 and the installation advice table in Section IV.1.3 if:

- **You only need to operate simple text applications.**
- **You are operating GEM applications, which automatically adjust to whatever display you are using.**

IV.1.1 The different Graphics Standards

Originally a low cost monochrome (green) screen was available, which displayed 25 lines of 80 characters, text-only using a 9×14 character matrix. This is very similar to a conventional computer VDU and is perfectly suitable for text based applications such as word processors, spreadsheets and most MS-DOS commands. This standard is named after the expansion card which provides these features, the 'MDA' or Monochrome Display Adapter.

To cater for users requiring graphics or colour, a second standard was available, produced by a 'CGA' or Colour Graphics Adapter. 25 lines of either 40 or 80 column text can be displayed, using an 8x8 character matrix, in 16 colours. Each character can have a different foreground and background colour. Additionally, the CGA is also capable of displaying graphics (ie each dot can be individually defined) in either 320x200 dot or 640x200 dot modes. In low resolution (320x200 dot) mode there are essentially three palettes each containing four fixed colours plus a user selectable background colour. The three palettes contain very similar colours. Medium resolution (640x200 dot) graphics are produced in a single user-selectable colour (nearly always white) on a black background. The CGA is supported by the MS-DOS commands **GRAPHICS**, **GRAFTABL** and **MODE**.

In response to the demand for graphics on monochrome displays the Hercules Graphics Adapter provides both text and dot addressability over the same area as used by MDA text, ie 720x350 dots. Many applications programs have been written to take advantage of these graphics facilities. However, the monochrome graphics mode is not supported at all by MS-DOS. As a result, additional commands are often supplied to print screens and change between the text and graphics modes. Some applications programs will change mode automatically for you as required, while others need help from the user via those additional commands.

The most recent development is the 'EGA' or Enhanced Graphics Adapter. This provides a monochrome graphics mode (completely incompatible with the Hercules Graphics Adapter!) as well as true high resolution colour. It will also operate with MDA and CGA software written to comply with the portability recommendations of the industry-standard specification (much doesn't!). The EGA can operate with a display designed for the CGA (when displaying only 8x8 matrix characters or 200 line graphics) but is also capable of generating 8x14 matrix characters and 350 line graphics which requires an Enhanced display. Both monochrome and high resolution colour text use the 8x14 character matrix.

Monochrome graphics operate with a resolution of 640x350 dots. Colour text is in 16 colours, the same as the CGA, while high resolution colour graphics are dot addressable in 16 colours chosen from a palette of 64 with a resolution of 640x350 dots. Most enhanced graphics software uses the same default set of 16 colours, which are much the same as those used for text. There is also an intermediate graphics mode, of interest to owners of standard colour displays, which displays 16 colours in the same 640x200 dot resolution as a CGA. There is no special support for the EGA in MS-DOS; other software is responsible for all enhanced mode switching.

(The PC1512 also has an intermediate 16 colour, 640x200 dot colour graphics mode. This is not compatible with the EGA, however, and software written for this mode of the PC1512 will only ever operate correctly in a PC1512.)

It is possible to operate with two graphics adapters installed in one machine. One must be an MDA (or Hercules with certain restrictions), the other a CGA or EGA. In each case, one is termed 'primary' the other 'secondary'. The primary adapter is where all the messages appear when the system is first switched on. Some switches will determine which adapter is the primary. With two graphics adapters you will, of course, require two displays! This is covered further in Appendix V 'Expanding Your Amstrad PC'.

Your PC1640 has a multi-function Internal Graphics Adapter (IGA) built in, which is capable of operating all these graphics standards (except the PC1512 16 colour

640×200 graphics). All you need to do is set the Display Selector switches on the rear of the system unit to suit the display you have and, perhaps, 'fine tune' with a special command provided. This command is called **DISPLAY** and a full description appears in Section IV.1.4. There are many examples of its use in the following sections.

You should use a PC MD for software designed to operate with a monochrome display adapter (MDA, Hercules or EGA Monochrome) and a PC CD or PC ECD for software designed to operate with colour display adapters (CGA or EGA). The PC ECD will operate with all colour software but the PC CD should only be used with CGA software and EGA software that you are quite sure will never attempt to generate high resolution 350 line graphics.

It is possible to 'convert' an ECD display into a CD display; simply set the display selector switches as if you had a PC CD.

Most software that is restricted to text only (remember that that includes certain block and line 'graphics' characters) should automatically work on all displays. Some text software will still require installation, and the user instructions for that software will probably include options for MDA/Hercules and CGA.

IV.1.2 Display selector switch settings

The display selector switch settings determine how the IGA (Internal Graphics Adapter) is configured when the machine is powered on or reset. These switch settings can be overridden by software, in particular by the **DISPLAY** command which is installed on all Hard Disk PCs and Disk 2 of your system disks. Many of the modes below have been given a name, unique to the Amstrad PC1640, in order to easily distinguish between them. These names are accepted by the **DISPLAY** command, which will switch to the requested mode, or print an error message if it is not possible or advisable.

Mode	Sw1	Sw2	Sw3	Sw4	Sw5	display	Description
MDTEXT	off	off	on	off	on	MD	MDA or Hercules Diag (1)
MDMONO	off	off	on	off	off	MD	EGA monochrome
	on	off	off	on	on	CD	CGA compatible 40 column
CDMONO	off	off	off	on	on	CD	CGA compatible 80 column (2)
	on	off	off	on	off	CD	EGA compatible 40 column
CDCOLOR	off	off	off	on	off	CD	EGA compatible 80 column
ECD200	on	on	on	off	off	ECD	EGA 200 lines
ECD350	off	on	on	off	off	ECD	EGA 350 lines (3)
all modes:			Sw6	Sw7	Sw8		Sw9 Sw10
			x	x	on - PC ECD		off off
					off - PC MD or PC CD		

- (1) Recommended setting for PC MD
- (2) Recommended setting for PC CD
- (3) Recommended setting for PC ECD

x = don't care

Notes:

- Modes with 'Sw5 On' are sometimes referred to as '6845 compatible' modes. In these modes, full MDA or CGA compatibility is ensured. Whatever the setting of Sw5, the command DISPLAY EGA turns off 6845 compatibility, and the command DISPLAY CGA or DISPLAY MDA (as appropriate to the display you are using) turns on 6845 compatibility.
- Sw8 does not affect software, but rearranges the electrical connection to the 9-pin video connector. It is important that it is set as specified, otherwise colours may be displayed incorrectly on the PC ECD.
- Other combinations of switch settings are possible in conjunction with additional graphics adapters fitted in an expansion slot. It is also possible to disable the IGA completely and install an alternative graphics adapter in one of your PC's expansion slots. These options are described in greater detail in Appendix V 'Expanding your Amstrad PC'.
- Sw6, Sw7 and Sw9 may be used to alter the character set displayed in high resolution text. This is described in greater detail in Appendix III 'The Amstrad PC Character Sets'.

IV.1.3 Choosing the correct graphics standard.

In general, software will operate in text and/or one graphics mode. If you require to operate a number of different software programs with graphics it is important to be consistent in your choice of graphics standard. It is important to realise that not all software will support all graphics standards. You will find that there is some software that you will not be able to use, once you have made your choice of display.

To run software designed for the:	Switch settings (see Section IV.1.2)	Command (only required if the software fails to run correctly)
MDA/Hercules Diag	MDTEXT or MDMONO	DISPLAY MDTEXT
Hercules Half	MDTEXT or MDMONO	DISPLAY MDHERC
Hercules Full	MDTEXT or MDMONO	DISPLAY MDHERC1
EGA monochrome	MDTEXT or MDMONO	DISPLAY MDMONO
CGA	CDMONO or CDCOLOR	
	or ECD200 or ECD350	DISPLAY CDMONO
EGA colour 200 line	ECD200 or ECD350	DISPLAY ECD200
EGA colour 350 line	ECD350	DISPLAY ECD350

To run the GEM software provided with your PC1640, insert Disk 1 if you have a floppy disk PC, then type **GEM**. Follow the instructions. The batch files should automatically load the most suitable version of **GEM**. The most suitable version is selected by the **AUTOEXEC.BAT** command when your PC is switched on or reset. Note that **CDCOLOR** is selected for the PC CD (rather than **CDMONO** which is implied by the recommended switch settings) in order to obtain the most colourful possible display. If for any reason the **AUTOEXEC** command has not performed correctly, or you wish to modify the operation of loading the GEM software, you can enter any of the following **DISPLAY** options as commands prior to typing **GEM**:

SET DISPLAY=MDHERC - Hercules 720×350
SET DISPLAY=MDMONO - EGA monochrome 640×350
SET DISPLAY=CDCOLOR - EGA 16 color 640×200

SET DISPLAY=CDMONO - CGA 2 color 640×200
SET DISPLAY=ECD350 - EGA 16 color 640×350

The **DISPLAY** options can be examined by typing the command **SET**. Note that these are the options that you, the user, require from the **DISPLAY** command, or software such as GEM. It does not, except by chance, reflect either the switch settings or instantaneous mode of the internal graphics adapter.

If you receive a warning message from the **GEM** batch file and the **GEM** software does not appear to load correctly, ie you do not get the expected DESKTOP screen, you will probably need to reset your PC then check the switch settings and **DISPLAY** options.

If you have software which normally loads directly, without requiring an operating system such as MS-DOS, and you find that you need to operate this software after a **DISPLAY** command has had its effect, use the command **DISPLAY BOOT** to load the software, after you have issued the required **DISPLAY <mode>** command. If required you can type one composite command **DISPLAY <mode> BOOT**.

IV.1.4 The DISPLAY command

This command is stored on Disk 2 of your Amstrad PC system disks, or in the Root directory of your Hard Disk.

DISPLAY

DISPLAY [*display-adapter-mode*|*display-type*] [BOOT]

Set the internal display environment.

The DISPLAY command is used:

- to set the display adapter mode
- to set the display type
- to load bootable software environments

Notes The DISPLAY command can only be used when the internal graphics adapter is enabled.

You can SET the environment DISPLAY= string to one of the valid DISPLAY parameters and if no parameter is specified on the command line then the environment string is used.

The error message **Invalid Parameter** will be displayed if you use an incorrect parameter string or try to use DISPLAY to set illegal combinations of display mode and display. When DISPLAY is invoked from a batch file this error message will return an error level 1.

The error message **Incorrect Environment** will be displayed if either the internal graphics adapter is disabled (see Appendix V) or DISPLAY is used on a non PC1640 computer. When DISPLAY is invoked from a batch file this error message will return either an error level 2 when an alternative external EGA is installed or an error level 3 if there is no alternative EGA.

- To set the display adapter mode

Form DISPLAY display-adapter-mode

Where the display-adapter-mode is one of the following options:

ECD350	EGA Enhanced Colour 350 line mode
ECD200	EGA Enhanced Colour 200 line mode
CDCOLO	EGA Colour Display 16 colour (640×200) mode
CDMONO	CGA Colour display 2 colour (640×200) mode
MDTEXT	MDA Monochrome Display Text only (or Hercules Diag.) mode
MDMONO	EGA Monochrome Display mode
MDHERC	Monochrome Display Hercules half mode
MDHERC1	Monochrome Display Hercules full mode
EGA	Enhanced Graphics Adapter mode
CGA	Colour Graphics Adapter emulation mode
MDA	Monochrome Graphics Adapter emulation mode
HERC0	Hercules Half emulation mode
HERC1	Hercules Full emulation mode
CGAB	A special CGA mode which allows screen blanking
PLANT	Plantronics 16 colour mode

Notes Parameter strings may be extended for clarity (ie CGABLINK can be used to specify CGAB, and CDCOLOR or CDCOLOUR to specify CDCOLO.)

In order to set a mode required by a bootable disk an additional BOOT parameter can be appended after the display-adapter-mode. When BOOT is specified the system firmware bootstrap is called directly after the display-adapter-mode is executed and the prompt:

**Insert a SYSTEM disk into drive A
Then press any key**

will be displayed at the top of the screen. If an illegal display adapter/display combination is specified (such as ECD350 when a Monochrome display is attached) then the message:

Invalid Parameter

will be displayed.

● **To set the display type:**

Form DISPLAY display-type

Where the display-type is one of the following:

:ECD Enhanced Colour Display.
:CD Colour Display.
:MD Monochrome Display.

Notes Parameter strings may be extended for clarity.

These parameters are very powerful and will change the display 'sync' signals. You must either ensure you have the correct type of display or have a multi-sync display. If the display is unsuitable, the screen will either roll continuously or go blank.

● **To load bootable software environments**

Form DISPLAY BOOT

Notes When BOOT is specified as the first parameter it is actioned immediately, any following parameters will be ignored.

The system firmware bootstrap will be called and the prompt:

**Insert a SYSTEM disk into drive A
Then press any key**

will be displayed. You may then insert the disk containing the bootable software into drive A, press any key and it will be loaded as though the computer was just switched on or reset with **Ctrl** **Alt** **Del**, EXCEPT that any display options previously set by the DISPLAY command are retained.

IV.1.5 Screen codes

The standard screen handling is a very simple Teletype mode.

Characters with internal codes in the range 32...255 (&H20...FF in the hexadecimal notation) are displayed on the screen at the current cursor position. Generally the cursor is then moved right by one column. If, however, the cursor is at the column furthest to the right and wrapping is enabled, it will move to the column furthest to the left on the next line, scrolling the screen up if necessary. If wrapping is not enabled, the final character on the line will be overwritten.

Characters with internal codes in the range 0...31 (&H00...1F) are treated as control codes as follows:

7 (&H07)	BEL (Bell): Sounds a bleep
8 (&H08)	BS (Backspace): Moves the cursor one column to the left. If the cursor is at the column furthest to the left and wrapping is enabled, it is moved to the column furthest to the right on the row above – unless it is already on the top row.
10 (&H0A)	LF (Line feed): Moves the cursor down one line, scrolling the screen up if necessary.
13 (&H0D)	CR (Carriage return): Moves the cursor to the column furthest to the left on the present row.
27 (&H1B)	ESC (Escape): Introduces an Escape sequence.

All other control codes are ignored.

If the CONFIG.SYS file (see Section V.3) is changed to include the command:

DEVICE=ANSI.SYS

extended screen handling facilities become available to you. These use standard ANSI screen control codes. The codes are as follows:

ESC [nA	Moves the cursor up <i>n</i> rows, unless it is already at the top of the screen. If <i>n</i> is omitted, the value 1 is assumed.
ESC [nB	Moves the cursor down <i>n</i> rows, unless it is already at the bottom of the screen. If <i>n</i> is omitted, the value 1 is assumed.
ESC [nC	Moves the cursor right <i>n</i> columns, unless it is already in the column furthest to the right. If <i>n</i> is omitted, the value 1 is assumed.
ESC [nD	Moves the cursor left <i>n</i> columns, unless it is already in the column furthest to the left. If <i>n</i> is omitted, the value 1 is assumed.
ESC [n;mF	Move the cursor to row <i>n</i> , column <i>m</i> . If <i>n</i> or <i>m</i> is omitted, the value 1 is assumed.
ESC [n;mH	Move the cursor to row <i>n</i> , column <i>m</i> . If <i>n</i> or <i>m</i> is omitted, the value 1 is assumed.
ESC [=nh	Set screen width and type (see Table 1, below)
ESC [2J	Clear the screen and return the cursor to its Home position.
ESC [K	Erase to the end of the line.
ESC [=nL	Reset screen width and type (see Table 1, below)
ESC [n;...;km	Set graphics parameters (see Table 2, below).
ESC [6n	Report current cursor position to the system.
ESC [standard-internal-code;parameter[;parameter...]p	where <i>parameter</i> is a decimal number or a string Map standard internal code associated with a key onto another code or sequence of codes, thereby redefining the keyboard.
ESC [n;mR	Specify current cursor position as row <i>n</i> , column <i>m</i> and report this position to the system.
ESC [s	Save the cursor position.
ESC [u	Restore the cursor position.

Table 1: Screen width and type

0	40 x 25 black and white
1	40 x 25 colour
2	80 x 25 black and white
3	80 x 25 colour
4	320 x 200 colour
5	320 x 200 black and white
6	640 x 200 black and white
7	wrap at end of line

Table 2: Graphics parameters

0	All attributes off
1	Bold on
2	Faint on
3	Italic on
5	Blink on
6	Rapid blink on
7	Reverse video on
8	Concealed on
30	Black foreground
31	Red foreground
32	Green foreground
33	Yellow foreground
34	Blue foreground
35	Magenta foreground
36	Cyan foreground
37	White foreground
40	Black background
41	Red background
42	Green background
43	Yellow background
44	Blue background
45	Magenta background
46	Cyan background
47	White background
48	Subscript
49	Superscript

IV.2 The keyboard

Most installation programs obtain the information they need about the keyboard by asking you to press specific keys at specific stages in the installation program. However, you may be asked to quote key codes instead and so these are listed here. The NVR program that sets the parameters stored in the Battery-backed RAM also accepts key codes as a way of expressing the meaning you want the **Enter** key, the **Del** key, the Joystick fire buttons and the Mouse buttons to have.

Notes: It is possible to set up the function keys of your PC to generate the strings of codes used, for example, by a word processor as an instruction to re-lay a paragraph. How to do this is outside the scope of this manual, but details should be obtainable from reference manuals on the operating system you will be using to run the program. The key tokens given here are the ones that apply by default. After KEYBUK.EXE (see Section V.3) has been run, Key 29 produces token 2923; Key 03 plus Shift produces token 0322; Key 04 plus Shift produces token 049C; and Key 28 plus Shift produces token 2840.

Keycodes and their translation

Key codes are translated to key tokens as follows (all values are in hexadecimal):

Key code	Normal	Alt	Ctrl	Shift	Num Lock	Key name
01	011B	Note 2	011B	011B	N/A	Esc
02	0231	7800	Note 2	0221	N/A	1 and !
03	0332	7900	0300	0340	N/A	2 and "
04	0433	7A00	Note 2	0423	N/A	3 and #
05	0534	7B00	Note 2	0524	N/A	4 and \$
06	0635	7C00	Note 2	0625	N/A	5 and %
07	0736	7D00	071E	075E	N/A	6 and ^
08	0837	7E00	Note 2	0826	N/A	7 and &
09	0938	7F00	Note 2	092A	N/A	8 and *
0A	0A39	8000	Note 2	0A28	N/A	9 and (
0B	0B30	8100	Note 2	0B29	N/A	0 and)
0C	0C2D	8200	0C1F	0C5F	N/A	- and _
0D	0D3D	8300	Note 2	0D2B	N/A	= and +
0E	0E08	Note 2	0E7F	0E08	N/A	◀Del
0F	0F09	Note 2	Note 2	0F00	N/A	Tab
10	1071	1000	1011	1051	N/A	Q
11	1177	1100	1117	1157	N/A	W
12	1265	1200	1205	1245	N/A	E
13	1372	1300	1312	1352	N/A	R
14	1474	1400	1414	1454	N/A	T
15	1579	1500	1519	1559	N/A	Y
16	1675	1600	1615	1655	N/A	U
17	1769	1700	1709	1749	N/A	I
18	186F	1800	180F	184F	N/A	O
19	1970	1900	1910	1950	N/A	P
1A	1A5B	Note 2	1A1B	1A7B	N/A	[and {
1B	1B5D	Note 2	1B1D	1B7D	N/A] and }

Key code	Normal	Alt	Ctrl	Shift	Num Lock	Key name
1C	1COD	Note 2	1COA	1COD	N/A	Return
1D	Note 2	Note 1	Note 2	Note 2	N/A	Ctrl
1E	1E61	1E00	1E01	1E41	N/A	A
1F	1F73	1F00	1F13	1F53	N/A	S
20	2064	2000	2004	2044	N/A	D
21	2166	2100	2106	2146	N/A	F
22	2267	2200	2207	2247	N/A	G
23	2368	2300	2308	2348	N/A	H
24	246A	2400	240A	244A	N/A	J
25	256B	2500	250B	254B	N/A	K
26	266C	2600	260C	264C	N/A	L
27	273B	Note 2	Note 2	273A	N/A	; and :
28	2827	Note 2	Note 2	2822	N/A	' and @
29	2960	Note 2	Note 2	297E	N/A	# and ~
2A	Note 2	Note 2	Note 2	Note 2	N/A	(Left) Shift
2B	2B5C	Note 2	2B1C	2B7C	N/A	\ and
2C	2C7A	2C00	2C1A	2C5A	N/A	Z
2D	2D78	2D00	2D18	2D58	N/A	X
2E	2E63	2E00	2E03	2E43	N/A	C
2F	2F76	2F00	2F16	2F56	N/A	V
30	306E	3000	3002	3042	N/A	B
31	316E	3100	310E	314E	N/A	N
32	326D	3200	320D	324D	N/A	M
33	332C	Note 2	Note 2	333C	N/A	, and <
34	342E	Note 2	Note 2	343E	N/A	. and >
35	352F	Note 2	Note 2	353F	N/A	/ and ?
36	Note 2	Note 2	Note 2	Note 2	N/A	(Right) Shift
37	372A	Note 2	7200	Print Screen	N/A	* and PrtSc
38	Note 2	Note 2	Note 1	Note 2	N/A	Alt
39	3920	3920	3920	3920	N/A	Space bar
3A	Note 2	Note 2	Note 2	Note 2	N/A	Caps Lock
3B	3B00	6800	5E00	5400	N/A	F1
3C	3C00	6900	5F00	5500	N/A	F2
3D	3D00	6A00	6000	5600	N/A	F3
3E	3E00	6B00	6100	5700	N/A	F4
3F	3F00	6C00	6200	5800	N/A	F5
40	4000	6D00	6300	5900	N/A	F6
41	4100	6E00	6400	5A00	N/A	F7
42	4200	6F00	6500	5B00	N/A	F8
43	4300	7000	6600	5C00	N/A	F9
44	4400	7100	6700	5D00	N/A	F10
45	Note 2	Note 2	PAUSE	Note 2	N/A	Num Lock
46	Note 2	Note 2	BREAK	Note 2	N/A	Scroll Lock
47	4700	Note 2	7700	N/A	4737	(Key pad) 7
48	4800	Note 2	Note 2	N/A	4838	(Key pad) 8
49	4900	Note 2	8400	N/A	4939	(Key pad) 9
4A	4A2D	Note 2	Note 2	N/A	4A2D	(Key pad) -
4B	4B00	Note 2	7300	N/A	4B34	(Key pad) 4
4C	Note 2	Note 2	Note 2	N/A	4C35	(Key pad) 5
4D	4D00	Note 2	7400	N/A	4D36	(Key pad) 6

*

Key code	Normal	Alt	Ctrl	Shift	Num Lock	Key name	
4E	4E2B	Note 2	Note 2	N/A	4E2B	(Key pad) +	
4F	4F00	Note 2	7500	N/A	4F31	(Key pad) 1	
50	5000	Note 2	Note 2	N/A	5032	(Key pad) 2	
51	5100	Note 2	7600	N/A	5133	(Key pad) 3	
52	5200	Note 2	Note 2	N/A	5230	(Key pad) 0	
53	5300	Note 2	Note 2	N/A	532E	(Key pad) .	
54-69	Note 2	Note 2	Note 2	Note 2	Note 2	undefined	
70		Set in the Battery-backed RAM					Del>
71-73	Note 2	Note 2	Note 2	Note 2	Note 2	undefined	
74		Set in the Battery-backed RAM					Enter
75-78	Note 2	Note 2	Note 2	Note 2	Note 2	undefined	
79	4D00	4D00	4D00	4D00	4D00	JSTCK RIGHT	
7A	4B00	4B00	4B00	4B00	4B00	JSTCK LEFT	
7B	5000	5000	5000	5000	5000	JSTCK DOWN	
7C	4800	4800	4800	4800	4800	JSTCK UP	

Note 1: The reset sequence is invoked by pressing **Ctrl**, **Alt** and **Del**

Note 2: These key translations are ignored.

The UP, DOWN, LEFT and RIGHT joystick key codes generate the same key tokens as their respective cursor keys.

The **Enter** key and the **Del>** key are set in the Battery-backed RAM.

IV.3 Device names

Device names under MS-DOS

CON	Both the keyboard and the screen
AUX or COM1	The Serial Interface
COM2	Reserved for use if a second communications port is added to your PC
PRN or LPT1	The Parallel Printer port
LPT2 } LPT3 }	Reserved for use if further parallel ports are added to your PC system

Appendix V: EXPANDING YOUR AMSTRAD PC

This appendix describes how to go about expanding your AMSTRAD PC system by:

- adding a printer or a communications link
- inserting an expansion board
- inserting an alternative graphics adapter
- adding a joystick
- adding an extra disk drive
- adding additional fonts

It gives both the technical aspects of choosing how to expand your system and explains the steps to incorporating these additions in your system. It also explains how to reconfigure your system software to accommodate the changes you have made.

Note: The mouse and the keyboard used with the AMSTRAD PC are special to this computer. They cannot be replaced by alternative units, even if these apparently fit the connectors - indeed, trying to do this is liable to damage the device and/or your PC.

V.1 Adding hardware

V.1.1 Making use of the Parallel Printer connector

The Parallel Printer connector on the back of the AMSTRAD PC System Unit is a 25-pin D-type connector, which provides a standard parallel (Centronics) interface and so can be used to connect any printer that uses a standard parallel interface. This gives you a wide choice of printers and plotters, though we would naturally recommend the AMSTRAD DMP3000 which is compatible with both EPSON FX80 and IBM Personal Computer Graphics Printer.

If you or your dealer are not sure whether a printer or a plotter is suitable, compare the pin-out and timing diagram given for the printer/plotter with the pin-out and timing diagram given below.

Computer Connector Pin	Printer Connector Pin	Return Pin	Designation	I/O	Notes
1	1	19	<u>STROBE</u>	IN	The signal level is normally high; it is taken low to send data. The pulse width must be more than 0.5 μ s at the receiving terminal (ie. your printer).
2	2	20	DATA 0 (LSB)	IN	8-bit data signal. Pin taken high corresponds to logical 1; pin taken low corresponds to logical 0.
3	3	21	DATA 1		
4	4	22	DATA 2		
5	5	23	DATA 3		

Computer Connector Pin	Printer Connector Pin	Return Pin	Designation	I/O	Notes
6	6	24	DATA 4		
7	7	25	DATA 5		
8	8	26	DATA 6		
9	9	27	DATA 7 (MSB)		
10	10	28	ACKNOWLEDGE	OUT	Pin taken low to indicate that your printer is ready to receive further data. Approximately 0.5 μ s pulse.
11	11	29	BUSY	OUT	Pin taken high to indicate that your printer cannot receive data.
12	12	30	PE	OUT	Pin taken high to indicate that your printer is out of paper.
13	13	-	SELECT	OUT	Pin taken high to indicate on-line; pin taken low to indicate off-line.
14	14	-	AUTOFEED	IN	Pin low means paper to be fed one line after printing.
-	15	-	NC		Not used.
-	16	-	0V		Logic GND.
-	17	-	CHASSIS GND		Printer chassis GND.
18	18	-	NC		Not used.
19...25	19...25 } 26...30 }	-	GND		Twisted-pair Return signal GND.
16	31	-	INIT	IN	Pin normally high; pin taken low to reset printer controller to its initial state and clear the printer buffer. Pulse width must be greater than 0.5 μ s at receiving terminal (ie. your printer).
15	32	-	ERROR	OUT	Pin taken low to indicate printer out of paper, off-line or in an error state.
-	33	-	GND		Twisted-pair Return signal GND.
-	34	-	NC		Not used.
-	35	-	5V		Pulled up to +5V through a 4.7k Ω resistance.
17	36	-	SLCT IN	IN	Data entry to printer only possible when pin low. Pin taken high to indicate printer off-line.

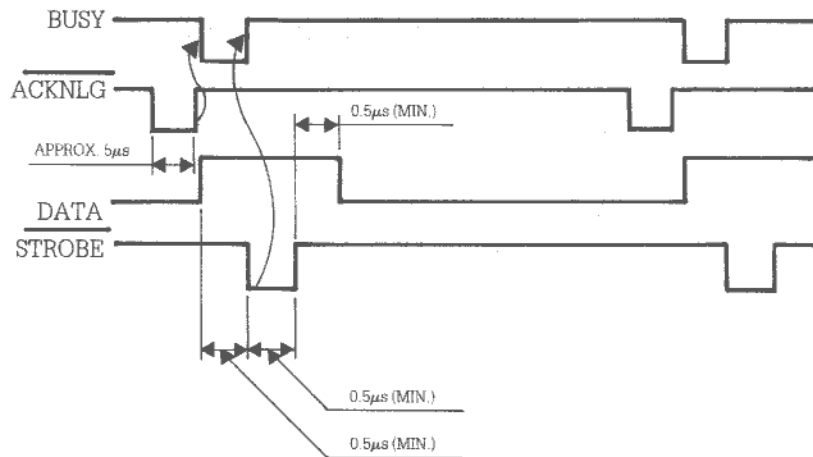

To make the connection between the printer/plotter and your PC, you will need an AMSTRAD PL-2 or equivalent IBM PC to Centronics printer cable. This cable should have a 'male' plug on one end to fit the 'female' connector on your AMSTRAD PC: the type of plug it should have on the other end depends on whether the printer has a 'male' or a 'female' connector. Your dealer should be able to help you here.

The 'male' end of this cable should be plugged into the Parallel Printer port on the back of your PC and the other end into the equivalent connector on the printer/plotter. If the 'male' plug on the end of the lead has slots for screws, use the screws supplied with the lead to attach it securely to the Parallel Printer port. Look at the printer/plotter's own manual to see how it recommends securing the lead to its connector.

If you attach a printer, find out from its manual which character set the printer uses. If it doesn't use the UK 8-bit ASCII character set, see if there is any switch on the printer that can change the character set used by the printer. The AMSTRAD DMP3000, for example, is factory set to the European version of the IBM character set, but has switches on it that change this to one of three other character sets.

Before you use the printer with the GEM software, you will also have to ensure that the operating system 'knows' about your printer. This involves having the Device Driver file for your printer/plotter on your Startup disk and editing the ASSIGN.SYS file to include the appropriate reference to this device driver file (see Section V.2).

If your printer is EPSON compatible (as both the AMSTRAD DMP3000 and the IBM Personal Computer Graphics Printer are), the device driver you need is stored in the file called EPSMONH6.SYS in the \GEMSYS folder on Disk 3. Other device drivers are available from Digital Research.

The ASSIGN.SYS files on Disk 2 are set up to make use of EPSMON6.SYS, so no special action is needed to output from the GEM software to an EPSON compatible printer. We describe the steps needed to output from GEM to other printers below in Section V.2.

> **MDLST** > If you have a PC MD then some applications software may expect a parallel printer connection configured in the same way as the parallel printer connector of an MDA or Hercules Graphics Adapter. The command MDLST will allow most of such software to access the Amstrad PC System Unit parallel printer connector instead.

V.1.2 Making use of the Serial Interface

The Serial Interface connector on the back of the AMSTRAD PC System Unit is a 25-pin D-type connector, which provides a standard RS232C interface and so can be used to connect any communications link or printer that uses the standard RS232C serial interface. This gives you a wide choice of modems, communications links and printers.

If you or your dealer are not sure whether a communications link or a printer is suitable, compare the pin-out given for the device with the pin-out given below.

Pin	Description
1	Frame Ground
2	Serial Data Output - TxD
3	Serial Data Input - RxD
4	Request to Send Output - RTS
5	Clear to Send Input - CTS
6	Data Set Ready Input - DSR
7	Signal Ground (Common Return)
8	Data Carrier Detect Input - DCD
9 - 19	Not used
20	Data Terminal Ready Output - DTR
21	Not used
22	Ring Indicator Input - RI
23 - 25	Not used

To make the connection between the device and your PC, you will need a suitable cable.

The type of cable you need depends on what you want to connect to the Serial Interface:

- **To connect to a Modem or a Desktop computer wired as a Modem, you need a 'one-to-one' RS232 cable**
- **To connect to a Serial Printer, a Terminal or a Desktop computer wired as a Terminal, you need a 'Null-modem' RS232 cable**

One way of checking whether a device is wired as a modem or as a terminal is to look at the type of connector on the device. Conventionally, devices wired as terminals have 'male' connectors and devices wired as modems have 'female' connectors. However, many manufacturers put 'female' connectors on both types of equipment for reasons of electrical safety, so the only sure way of telling is by finding out from the device's manual how Pin 2 is wired:

- if Pin 2 is used to **transmit** (ie. Pin 2 is an output pin), then the device is wired a terminal and you need a Null-modem cable
- if Pin 2 is used to **receive** (ie. Pin 2 is an input pin), then the device is wired as a modem and you need a one-to-one cable

Your cable should have a 'female' plug on one end to fit the 'male' connector on your AMSTRAD PC: the type of plug it should have on the other end depends on whether the device you are connecting to has a 'male' or a 'female' connector. Your dealer should be able to help you here.

The 'female' end of this cable should be plugged into the Serial Interface port on the back of your PC and the other end into the equivalent connector on the device. If the 'female' plug on the PC end of the lead has screw holes, use the screws supplied with the lead to attach it securely to the Serial Interface port. Look at the device's own manual to see how it recommends securing the lead to its connector.

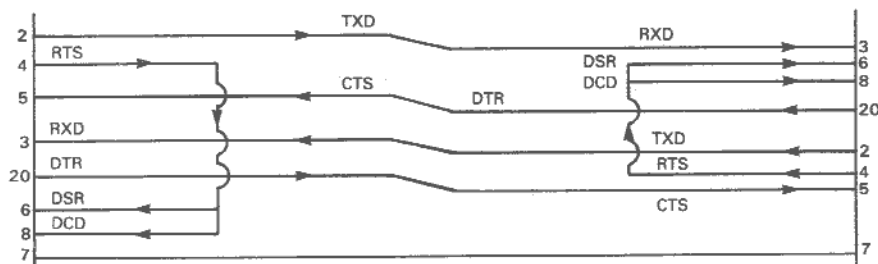

Recommended Null-modem cable wiring

The next step is to set up the Serial Interface so that data is transmitted with the right characteristics and received data is correctly interpreted. Your device's manual should tell you what values you need to set.

If you plan to use the Serial Interface almost entirely to link your PC with a particular printer or a particular terminal or modem, the best way to do this is through the NVR program – the program that sets the parameters stored in your PC's battery-backed RAM. That way, there will be no need to reset these values (unless you allow the batteries to go flat).

If you expect to use the Serial Interface to link your PC with a range of external devices, make the settings either by using a MODE command (see Part III, Section 7.1). The command line could usefully be included in the Batch file to run a particular program or in the AUTOEXEC.BAT file on a particular Startup disk.

Before you use a printer attached to the Serial Interface with the GEM software, you will also have to ensure that the operating system 'knows' about your printer. This involves having the Device Driver file for your printer on your Startup disk and editing the ASSIGN.SYS file to include the appropriate reference to this device driver file (see Section V.2).

If your printer is EPSON compatible (as both the AMSTRAD DMP3000 and the IBM Personal Computer Graphics Printer are), the device driver you need is stored in the file called EPSMONH6.SYS in the \GEMSYS folder on Disk 3. Other device drivers are available from Digital Research. We describe the steps needed to install a device driver below in Section V.2.

V.1.3 Installing an expansion board

Included within the AMSTRAD PC System Unit are slots for up to three IBM PC-compatible expansion boards.

Expansion boards are sections of electronic circuitry, each on a single piece of printed circuit board that connect to the main 'Mother' board and provide your PC system with extra functions. There are expansion boards for IBM PCs and PC-compatibles that provide internally fitted modems; expansion boards that enable the PC to be incorporated in a network of computers; etc. etc.

Most of these cards can be used in the AMSTRAD PC. However, some 'multifunction' and memory cards may not be appropriate to your PC. Your dealer should be able to advise you on this.

The only piece of equipment you need to install an expansion board in your AMSTRAD PC is a medium-sized Philips-head screwdriver. The steps to take are as follows:

- 1 Switch off your PC and any printers, etc. you have attached to it, and unplug all of these from the mains supply.**
- 2 Disconnect printers, etc. from the PC System Unit. Also disconnect the display from the System Unit.**
- 3 Lift the display out of the recess in the top of the System Unit and put it to one side.**
- 4 Slide back and remove the cover to the back section of the System Unit. If this is the first expansion board to be installed in your PC, also slide back and remove the cover on the back righthand corner of System Unit.**

The picture below illustrates where these two covers are.

You should now be able to see the three expansion board slots on the righthand side.

- 5 Use the screwdriver to remove the expansion slot screw**

Turn the screw anti-clockwise to undo it. Save the screw.

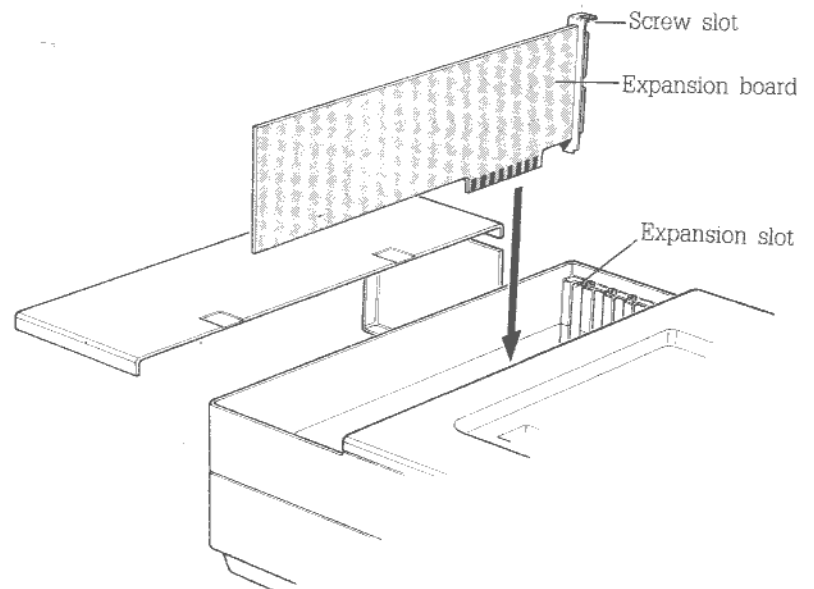

6 Press the expansion board firmly into the slot.

Start by holding the expansion board by its top edge above the slot. The way round to hold it is illustrated in the picture on the next page.

7 Align the screw slot on the expansion board with the screw hole of the expansion slot. Insert the screw and tighten it.

Turn the screw clockwise to tighten it.

8 Replace the top System Unit cover.

Only put back the side cover if the expansion board isn't to be connected to an external device.

9 If the expansion board is to be connected to an external device, connect the appropriate cable to the connector which will now be showing on the righthand side of the System Unit.

10 Replace the display on the top of the System Unit.

11 Re-attach all cables.

12 Run the install program for the expansion board (if any).

If there is an install program to run, the program will be provided with the board and there should be full instructions on how to use the program in the booklet describing the expansion board.

V.1.4 Adding a Graphics Adapter

It is possible to operate your Amstrad PC with additional graphics adapters, provided a few simple rules are obeyed. These additional graphics adapters can be:

- **one other graphics adapter fitted in an expansion slot with the Internal Graphics Adapter (IGA) still enabled**
- **one/two graphics adapters fitted in one/two expansion slots while the IGA is disabled.**

The rules for operating with additional graphics adapters are embodied in the tables below.

You may require a second display, which can be positioned next to your PC system unit. An Amstrad PC display must be used to provide power to the system unit. It is not possible to operate with a second Amstrad PC display unless you draw power from its DC cable.

Normally the **Please wait..** message will appear on all displays, but the **Amstrad PC640K** messages and subsequent MS-DOS prompts will only appear on one display. That display is called the primary display and is connected to the primary display adapter. If you have another display then that is called the secondary display. The setting of switches is very important in determining the primary display. Your PC will attempt to send all messages to the primary display you have nominated - even if there is no suitable display adapter fitted!

If you have two displays fitted, the rules dictate that one will always be monochrome, the other colour. In this case the monochrome display will operate with software of types MDTEXT, MDHERC and MDMONO (but not MDHERC1). The colour display will operate with all CD or ECD software as appropriate.

#

When you are operating your PC with two display adapters the display you will use is determined initially by:

- **The primary adapter switch settings**
and subsequently by:
- **Instructions within applications software**
- **The MODE command**
- **The DISPLAY command (eg the GEM software batch files on Disk 2)**

V.1.4.1 IGA enabled; one additional graphics adapter

Sw1	Sw2	Sw3	Sw4	Sw5	IGA as Primary Mode:	display:	Additional adapter as secondary
#	off	on	off	on	MDA or Hercules ⁽¹⁾	MD	CGA
#	off	on	off	off	EGA monochrome	MD	CGA
#	off	off	on	on	CGA compatible ⁽²⁾	CD	Monochrome
#	off	off	on	off	EGA compatible	CD	Monochrome
on	on	on	off	off	EGA 200 lines	ECD	Monochrome
off	on	on	off	off	EGA 350 lines ⁽³⁾	ECD	Monochrome

Sw1	Sw2	Sw3	Sw4	Sw5	IGA as Secondary Mode:	display:	Additional adapter as primary
#	on	off	on	on	MDA or Hercules Diag	MD	CGA
#	on	off	on	off	EGA monochrome	MD	CGA
#	on	on	on	on	CGA compatible	CD	Monochrome
#	on	on	on	off	EGA compatible	CD	Monochrome
on	off	on	on	off	EGA 200 lines	ECD	Monochrome
off	off	on	on	off	EGA 350 lines	ECD	Monochrome

all modes: Sw6 Sw7 Sw8 Sw9 Sw10
 x x on - PC ECD off off
 off - PC MD or PC CD

on = 40 column colour, off = 80 column colour

- (1) Recommended setting for PC MD
- (2) Recommended setting for PC CD
- (3) Recommended setting for PC ECD

V.1.4.2 IGA disabled, one additional graphics adapter

Sw6	Sw7	Additional graphics adapter is:
off	off	EGA - mode set by switch settings on EGA ⁽⁴⁾
on	off	CGA (40 column)
off	on	CGA (80 column)
on	on	MDA or Hercules Graphics Adapter

all modes: Sw1,2,3,4,5,8,9 don't care; Sw10 on
 (4) Consult the user instructions for the EGA card.

Note: It is Switch 10 which disables the IGA. When the IGA is disabled Sw6 and Sw7 (formerly used to select IGA foreign character sets, see Appendix 3) are used as graphics adaptor selectors.

V.1.4.3 IGA disabled, two additional graphics adapters

Sw6	Sw7	Additional adapter as primary	Additional adapter as secondary
off	off	EGA ⁽⁵⁾ CGA or Monochrome	Monochrome or CGA EGA ⁽⁵⁾
on	off	CGA (40 column)	Monochrome
off	on	CGA (80 column)	Monochrome
on	on	Monochrome	CGA

all modes: Sw1,2,3,4,5,8,9 don't care; Sw10 on

(5) Set by switches on the EGA. Consult the user instructions for the EGA card.

Note: It is Switch 10 which disables the IGA. When the IGA is disabled Sw6 and Sw7 (formerly used to select IGA foreign character sets, see Appendix 3) are used as graphics adaptor selectors.

V.1.5 Adding a joystick

Some of the software you buy may use a joystick or you may want to use a joystick instead of the cursor keys. You can use any Industry Standard joystick with your AMSTRAD PC, but if you want to check whether a joystick is suitable, compare its pin-out with the pin-out shown below.

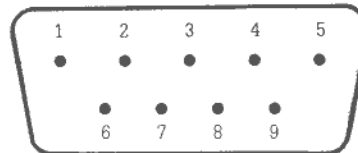

Pin 1	Up	Pin 6	Fire 2
Pin 2	Down	Pin 7	Fire 1
Pin 3	Left	Pin 8	Common
Pin 4	Right	Pin 9	Not connected
Pin 5	Spare		

When you want to use your joystick, connect it by inserting the 9-way 'D-type' plug on the end of the joystick cable into the socket on the back of the keyboard.

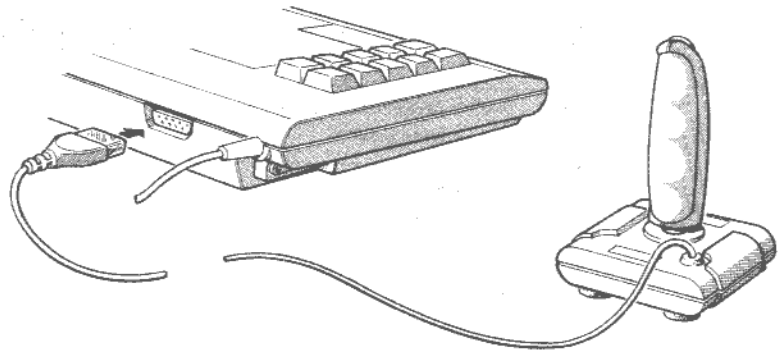

Note: You can also use an IBM analogue (infinitely variable) joystick with your AMSTRAD PC. However, this is installed rather differently because it uses its own expansion board. To use this type of joystick, follow the instructions on installing an expansion board given above in Section V.1.3 and attach the joystick cable to the connector on the expansion board, not to the one on the back of the keyboard.

V.1.6 Adding an extra disk drive

If you have a single-drive PC, you may well want at some stage to expand your system to two floppy drives or to add a Winchester disk. **SUCH MODIFICATIONS MAY ONLY BE CARRIED OUT BY AUTHORISED PERSONS: ANY MODIFICATION BY UNAUTHORISED PERSONS INVALIDATES THE AMSTRAD GUARANTEE.**

After the new disk drive drive has been added to your PC, you may have to:

- **set up some special commands in MS-DOS's CONFIG.SYS file if the new disk drive is in any non-standard**
- **reconfigure your GEM Desktop so that the disk drives are shown correctly when the Desktop is showing Disk Drives**

Changing the CONFIG.SYS file to accommodate additional or different disk drives is outside the scope of this manual. You should either refer to the AMSTRAD PC Technical Reference (available from AMSTRAD) or seek the advice of someone who understands both MS-DOS and the requirements of your new disk drive, for example your dealer.

Reconfiguring the GEM Desktop so that all your disk drives are shown correctly is straightforward to do. The steps are as follows:

- 1 **Go into the GEM Desktop and close up one of the windows until it shows the Disk Drives on your machine.**
- 2 **Select the icon representing your new disk drive.**
- 3 **Pull down the Options menu and select 'Install Disk Drive...'**



An Install Disk Dialog box will appear on the screen.

INSTALL DISK DRIVE		<input type="button" value="Install"/>
Drive Identifier:	<input type="text" value="E:"/>	<input type="button" value="Remove"/>
Icon Label:	<input type="text" value="FLOPPY DISK_"/>	<input type="button" value="Cancel"/>
Icon Type:	<input checked="" type="button" value="Floppy"/> <input type="button" value="Hard"/>	

4 Set the Drive Identifier, Icon Label and Icon Type for your new disk drive.

The Drive Identifier is set by typing the appropriate letter in the first text field of the Dialog box. The Icon Label is set by typing in an appropriate title (like Floppy Disk or Hard Disk) in the second text field. The Icon Type is set by clicking on the appropriate option button.

5 When you have set all the parameters you want, click on the [Install] exit button.

6 Save the Desktop, as described in Part II, Section 8.2.

Remember, a wide range of parameters are saved as your chosen initial Desktop style when you save the Desktop. Make sure that all the parameters are set as you wish **before** you save the Desktop.

Your new disk drive is then installed in your GEM Desktop.

V.2 Adding system software

The extra system software you may need are:

- **device drivers for any printer, plotter or special monitor you add to your system – so that you can use these with the GEM software**
- **extra character fonts to give you a wider range of type sizes and type styles to use within GEM**

This extra software is available from Digital Research, along with a special program called GEM SETUP which you need to help you install the device drivers and fonts.

To use a device driver, you need to store the file holding the device driver in a directory that is automatically searched by MS-DOS while it is running GEM. The \GEMSYS folder on Disk 3 or Disk 4 is as good a choice as any: this is where the EPSMONH6.SYS device driver, suitable for use with EPSON compatible printers, is stored. Any extra fonts you acquire should also be stored in this directory.

You will need to modify the ASSIGN.SYS file so that it includes details of the new device-driver and font files. The ASSIGN.SYS file is stored in \GEMSYS folder on the GEM Startup disk. Special commands in a batch file select the correct display device driver by choosing the ASSIGN.SYS file from a number of possible files named after the DISPLAY parameter used to load the GEM software. For example, if you have a PC CD then the DISPLAY parameter will normally be set to CDCOLOR, and the ASSIGN.SYS file used will be a copy of the file CDCOLOR.ASS stored in the \GEMSYS folder. You should modify both the ASSIGN.SYS file (if it exists) and any '.ASS' files corresponding to DISPLAY parameters you intend to use. To examine your current DISPLAY parameter, load GEM, select 'EXIT TO DOS' in the File menu; then type SET .

*

Use the RPED text editor both to see what its current form is and to change it. (How to use RPED explained in Part I, Section 6.8 and 7.8.) You should see something like this:

```
;2nd type of assign.sys file:
01 IBMELFP6;EGA Color Display (640x200) 16 colors
; Amstrad Mouse (uses MOUSE.COM)
; ANSLSS10.FNT;AMSTRAD 640 x 200 Swiss 10 Point
; ANSLSS14.FNT;AMSTRAD 640 x 200 Swiss 14 Point
; ANSLSS18.FNT;AMSTRAD 640 x 200 Swiss 18 Point
; ANSLSS36.FNT;AMSTRAD 640 x 200 Swiss 36 Point *
; ANSLTR10.FNT;AMSTRAD 640 x 200 Dutch 10 Point
; ANSLTR14.FNT;AMSTRAD 640 x 200 Dutch 14 Point
; ANSLTR18.FNT;AMSTRAD 640 x 200 Dutch 18 Point
; ANSLTR36.FNT;AMSTRAD 640 x 200 Dutch 36 Point *
21 EPSMONH6;Amstrad/Epson Graphics Printers High Resolution mode
; Printer Parallel Port #1 ( LPT1: )
; EPSHSS07.FNT;EPSON H1 Res Swiss 7 Point
; EPSHSS10.FNT;EPSON H1 Res Swiss 10 Point
; EPSHSS14.FNT;EPSON H1 Res Swiss 14 Point
; EPSHSS20.FNT;EPSON H1 Res Swiss 20 Point *
; EPSHSS28.FNT;EPSON H1 Res Swiss 28 Point *
; EPSHSS36.FNT;EPSON H1 Res Swiss 36 Point *
; EPSHTR07.FNT;EPSON H1 Res Dutch 7 Point
; EPSHTR10.FNT;EPSON H1 Res Dutch 10 Point
; EPSHTR14.FNT;EPSON H1 Res Dutch 14 Point
; EPSHTR20.FNT;EPSON H1 Res Dutch 20 Point *
; EPSHTR28.FNT;EPSON H1 Res Dutch 28 Point *
; EPSHTR36.FNT;EPSON H1 Res Dutch 36 Point *
31 METAFIL6;GEM File
```

To put in details of your new printer driver, change the line referring to the EPSMONH6 printer driver to:

```
21 printer-driver
```

where the name of the printer driver file is *printer-driver.SYS*

Similarly, to put in details of a plotter driver, insert above this line:

```
11 plotter-driver
```

and to put in details of a new monitor driver, change the first line to:

```
01 monitor-driver
```

The actions needed to install new font files is very much the same. All you need to do is to insert details of any new screen font files in the block below the top line, and insert details of any new printer font files in the lower block. (Delete from either block any font files you no longer want to use.)

.V.3 Configuring your MS-DOS system software

MS-DOS Version 3.2 is initially configured to suit a wide range of 16-bit microcomputers. On the AMSTRAD PC, this configuration is modified by settings in the CONFIG.SYS file in the Root directory of the MS-DOS Startup disk. This file is automatically processed by MS-DOS as part of the Startup procedure. Further changes to the configuration can be made by:

- **modifying the CONFIG.SYS file**
- **running a program called ANSI.COM**
- **loading a different keyboard program**

Changing the CONFIG.SYS file

The commonest reasons for changing the CONFIG.SYS file are:

- to increase the number of disk buffers if your work involves a lot of disk accessing
- to increase the number of files that can be open simultaneously

The CONFIG.SYS file draws on special commands, full details of which can be found in the AMSTRAD PC Technical Reference (available from AMSTRAD). The ones covered here are the ones that don't need special technical knowledge to use. These are, in any case, the ones you are most likely to need.

BREAK=ON OFF	This does a similar job to the MS-DOS BREAK command, increasing the number of times MS-DOS checks whether Ctrl-C has been pressed when BREAK is set to ON and limiting the checking to when the program is using the keyboard or the screen when BREAK is set to OFF .
BUFFERS=n	This command sets the number of sector buffers available when data is transferred to and from disk. A word-processor program will typically need 10...20. You will also need a large number of buffers if you have many subdirectories on any disks, but don't set a number higher than you need because each buffer takes 0.5K of RAM. The AMSTRAD PC is supplied with 5 buffers; the default number is 2.
COUNTRY=nnn	This command tells MS-DOS to use the time, date and currency convention of the country specified by <i>nnn</i> . <i>nnn</i> is the three-digit number used to represent the country in the International Dialling Codes: so the UK is 044 and the US is 001 .
FCBS=x,y	This command sets the number of files opened by File Control Blocks (FCBs) that can be open at any one time (<i>x</i>) and the number (<i>y</i>) that are protected against being closed automatically by MS-DOS if an application tries to open further files. The possible range for <i>x</i> is 0...255 (default 4)
FILES=n	This command sets the number of file handles that can be in use simultaneously. The possible range is 8...255, though 20 is the maximum in practice. The AMSTRAD PC is supplied with a limit of 20 file handles; the default number of file handles is 8.

Running ANSI.COM

The ANSI.COM program is designed to take settings stored in the Battery-backed RAM and pass these as a string to the ANSI.SYS file.

ANSI.SYS is the enhanced screen driver that can be loaded through a **DEVICE=ANSI.SYS** command in the CONFIG.SYS file. The initial settings of screen colours, etc. while you are using MS-DOS are those stored in the Battery-backed RAM: these are automatically loaded by ANSI.SYS. However, some application programs will destroy these settings, often reverting to white characters on a black background. Running ANSI.COM will restore the initial screen colours.

Loading a different keyboard program

- > **KEYBUK** > Keyboard layout varies from country to country, because of the different needs of the languages spoken there.

MS-DOS is initially set up to work with an American style keyboard. However, it can be configured to work with a different national keyboard by running a special program. This program has the name **KEYBxx**, where **xx** indicates the which national keyboard layout will be set. For UK keyboards, the command is **KEYBUK**.

The AMSTRAD PC is supplied with an **AUTOEXEC.BAT** which invokes the correct **KEYBxx** program for the country in which it is sold, each country is only supplied with one keyboard program.

Note: There are few differences between a US keyboard and a UK keyboard. In general, you will be able to use MS-DOS programs perfectly well without running **KEYBUK**.

Making use of the PC's clock

- > **RTC** > The supplied MS-DOS operating system is able to make direct use of the AMSTRAD PC's internal clock/calendar.

To make use of the internal clock/calendar while running other PC-DOS compatible operating systems, you must run a special program called **RTC.COM**. This is stored in the Root directory of Disk 1 of the AMSTRAD PC disks.

You would normally run **RTC** from the **AUTOEXEC.BAT** file on the relevant Startup disk.

Once **RTC** has been run, the settings of the operating system's clock and calendar will match your PC's clock/calendar.

Note: After **RTC** has been run, any changes that you make to the operating system clock and calendar (for example, by using **DATE** and **TIME** commands) will also be made to your PC's internal clock.

RTC is not required if you use the MS-DOS supplied on Disk 1.

Appendix VI: REFERENCE MATERIAL ON THE AMSTRAD PC

The majority of this manual covers the everyday use of your AMSTRAD PC. It illustrates how to use your PC to run GEM or IBM compatible software which you have bought, plus the use of GEM Desktop and DOS commands to organise and maintain your program and data files. It also contains a brief introduction to Locomotive BASIC 2, the powerful, graphics-based BASIC provided with the AMSTRAD PC.

If you want to run non-compatible applications and write programs in other languages to run under MS-DOS, you may require a more detailed knowledge of your AMSTRAD PC. This is beyond the scope of this user guide. However, to help you acquire this knowledge, this appendix summarises the information you will need to know and the technical manuals you will need to buy.

Your AMSTRAD PC system consists of hardware and software.

The hardware is the computer itself – the keyboard, the monitor, etc. This is useless without software to control it. The software comes in various types from very low level software that controls the hardware to application programs such as word processors or spreadsheets.

The hardware and the various levels of software are described in a variety of technical manuals. These are listed below.

Guides to the software

The various levels of software you use on your AMSTRAD PC are:

- **Application programs such as a spreadsheet, word processor etc**
- **Graphics handling systems, Virtual Device Interface (VDI) and Application Environment Services (AES) necessary to run GEM based applications**
- **An operating system ie. MS-DOS**
- **The very low level software which controls the physical hardware. This is variously known as the Resident Operating System (ROS), the ROM or the firmware.**

Applications programs make certain common demands of your PC, such as reading and writing files, displaying information etc. However, all the information you need to run the programs should be given in their own user guides.

Graphics handling For detailed information about writing programs to run using the features of GEM (icons, menus, scroll bars etc) and for descriptions of the component parts of GEM (VDI and AES), consult:

GEM Programmer's Toolkit

available from Digital Research

Note: It is unlikely that an application not written specifically for GEM can be converted to use GEM's features other than by rewriting it! You should run these programs directly from MS-DOS. This is described in Part III, Chapter 4.

The operating system handles all the common functions which the applications need, and provides housekeeping facilities through two special applications: the Command Interpreter or GEM Desktop. (The functions provided by the Command Interpreter and GEM Desktop are described in this manual.)

For information on the structure of MS-DOS, reading and writing files and disks, control of the console and other peripherals, see:

MS-DOS Programmers' Reference Manual version 3.1 published by Microsoft

BASIC 2 This manual provides only a very brief introduction to Locomotive BASIC 2. A comprehensive user guide and a full reference manual are available as follows:

Locomotive BASIC 2 User Guide published by AMSTRAD
BASIC 2 Technical Reference available from Locomotive Software

The AMSTRAD PC hardware

Using the hardware through the operating system can be slow, and many commercially available software packages use the firmware or hardware directly.

For information on the hardware and firmware of the AMSTRAD PC:

AMSTRAD PC Technical Reference published by AMSTRAD

The Hardware sections will provide details of, for example, the full range of functions of which the screen is capable and how to use them.

The Firmware sections describe the low level interface to the hardware, and will indicate how to call the functions described in the hardware specification.

The Technical Reference also describes the MOUSE.COM program supplied with the AMSTRAD PC and the full range of CONFIG.SYS commands.

Add-on hardware

You can add hardware to your PC in two ways: simply plugging the add-on hardware (such as a printer) into one of the sockets on the AMSTRAD PC System Unit, or by adding the hardware along with its 'interface'. The 'interface' or 'expansion card' is a computer board which you or your dealer can fit into one of your PC's IBM compatible expansion slots. You should refer to the fitting instructions which accompany the add-on, and read them in conjunction with Appendix V.

If you need to use add-on hardware from your own programs, or install software you have bought to use add-on hardware, you should refer to the user manual accompanying the add-on hardware. It may be that there is a hardware specification available for your add-on. If there is, use it as an extension of the AMSTRAD PC's hardware specification.

Appendix VII: TROUBLESHOOTING

This appendix looks at what to do and what might have gone wrong when your PC or your program doesn't work in the way you expect. If you can't find the solution to your problem here, consult your dealer.

Note: Your PC will normally beep if it fails to read a disk or if it can't accept the character you just typed. If you don't hear any beep, adjust the volume control on the lefthand panel of the System Unit (next to the connectors for the keyboard and the mouse).

VII.1 Trouble during Startup or when resetting your PC

- **If nothing happens at all**

Check that the mains socket is working by plugging in and switching on a lamp you know is working.

Check that the PC's mains plug is correctly wired and that the fuse in the plug has not blown.

If neither of these actions shows you where the problem is, consult your dealer.

- **The PC beeps and asks you to insert a System disk when you insert your Startup disk**

Check that you inserted the right disk and then reset the machine. If it beeps again, the disk it is trying to read either is damaged or does not have any operating system software on it. Try another Startup disk: if you don't have another Startup disk or if your PC fails to read this disk as well, consult your dealer. The problem could simply be that your disk drive needs cleaning, in which case your dealer will be able to tell you which cleaning product is recommended for use on the AMSTRAD PC.

As soon as possible after this failure, use MS-DOS's CHKDSK command (see Part III, Section 6.3) to find out whether the disk that failed was damaged.

- **Software is read into your PC's memory but the machine dies**

Check that you inserted the right disk and then reset the machine. If your PC dies again, the software on your disk has been corrupted. Try another Startup disk: if you don't have another Startup disk, consult your dealer.

- **The screen display when all the software has been read in is plausible but isn't what you expected**

You have used either a disk that has been set up to run an application program immediately after loading the system software or a disk with different system software on it. Which has happened will be apparent from the screen display.

Either leave the application program by holding down the **Ctrl** key and pressing the **Break** key, or reset your PC using another Startup disk.

- **When using the mouse with the Desktop the pointer leaves a trail of 'arrows'**

Check you are using the correct screen driver for the PC you have.

Note: The PC1512 and PC1640 use different screen drivers.

VII.2 When commands fail

Commands fail because:

- you have made a typing error in the command line
- you haven't specified the location of a file correctly
- you haven't got enough memory space for the program to run
- you haven't got enough room on the disk to store the new files the program produces
- the file holding the program has been corrupted
- you are trying to use an external command or a program under the wrong operating system

You can usually tell why a command has failed from what appears on the screen.

- **If the operating system puts up a name followed by Bad command or file name or a question mark, it hasn't found the command, program or batch file you wanted to run.**

The commonest reason for this is that you mistyped the command name. For example, you might have typed COYP instead of COPY. The other possibility is that the program file isn't in the directory or directories the operating system searched. You may have misdirected the operating system, for example because you forgot which disk you had in the drive. Check where you told the operating system to look for the file.

- **If the operating system puts up a message like 'File not found' together with a file specification, it hasn't found one of the files you asked it to process.**

Either you mistyped the filename or the filetype. Or the file isn't in the directory you specified. Check where you told the operating system to look for the file.

In either of these cases you can either retype the command line at the new system prompt or copy and then edit your previous command line. The keystrokes to help you do this are described in Part II, Section 4.2.1. When you have finished editing the command line, press the key.

- **If the operating system puts up some other message like 'Memory insufficient to run program' or 'Disk full', it has met some other problem in carrying out your command.**

Look up the message in Sections VII.7 - 10 and then take whatever action is appropriate. You may, for example, need to erase some files you no longer need from the disk or change what you are trying to do.

- **If the screen goes blank or your PC generally seems dead**

If this happens immediately after you type the command line to run the program, check in the program's user guide precisely which operating system you are supposed to run this program under. This includes checking the version number. It could be that the program will only work with a specific version of, say, MS-DOS - for example MS-DOS 2.0.

If the screen goes blank after the program has run for a little while, first try typing Ctrl-Q (by holding down the **Ctrl** key and pressing **Q**). It could be that you accidentally caused the program to pause.

If these actions don't help you identify what the problem is, reset your PC (See Part I, Section 8.3) and then try again. If the same failure happens again and it's a program that you have written or edited, try again with your back-up copy of the program and/or check the program. If the program is one you have bought, try again using your master copy of the program: if that fails too, consult your dealer.

- **If you fail to run a GEM application from the GEM Desktop**

It could be that your PC does not have enough memory available to run this application. If you set aside some of your computer's memory for use as a built-in disk (Drive C:), one possible solution is to reduce the size of this RAM disk. Use the NVR program to adjust its size. Another option you have is to use a narrower range of screen fonts: this involves reducing the number of screen font files listed in your ASSIGN.SYS file (see Appendix V, Section V.2).

VII.3 Trouble with the keyboard

- **If your PC fails to respond to what you type**

Check whether the cursor is flashing on the screen. If it is, check that the keyboard cable is connected firmly into the keyboard socket on the side of the PC System Unit. If your PC still doesn't respond, switch off, wait for a little while and then switch back on and go through the normal Startup procedure. If your PC still fails to respond to your keyboard, consult your dealer.

If the cursor isn't flashing, something in your program has caused your PC to 'die'. Put your Startup disk into Drive A and reset your machine by holding down **Ctrl** and **Alt** and pressing **Del**. If your PC still fails to respond, release the disk(s) from the drive(s), switch your machine off and then switch it on again and go through the standard PC Startup procedure (see Part I, Section 8.1).

If your PC still fails to respond to your keyboard, consult your dealer.

- **If you get cursor movement when you thought you were using the Numeric keypad (and vice versa)**

Press the **Num Lock** key and then try again.

- **If the cursor keys don't move the pointer on the GEM Desktop**

Press the **Ctrl** key and try again.

- **If you get upper case letters when you were expecting lower case letters**

Press the **Caps Lock** key and try again.

- **If characters you type in overwrite what you have already typed in, rather than get inserted into your text**

Press the **Ins** key and try again.

- **If the keys don't produce the actions/characters you expect**

You may have used the KEYBxx utility from a different DOS-compatible operating system. You must use the operating systems supplied with your PC to get full keyboard, joystick and mouse support.

VII.4 Trouble with a disk drive

Floppy Disk drive

If your PC frequently reports that it can't read or write to a disk drive, it could be that your disk drive is the problem rather than your disks. A likely cause of trouble is that the disk drive is in need of cleaning.

A number of cleaners are available but not all are recommended for use on the AMSTRAD PC. Your dealer will be able to advise you on which one to use.

If cleaning the disk drive doesn't solve the problem, either get the drive fixed or replace it with a new one as soon as possible. Your dealer will be able to help you here. Don't limp on with a defective drive - you could easily damage your disks - and don't try using a two-drive machine as a single-drive system by disconnecting the defective drive. If you do, (i) you will invalidate the warranty on your PC, and (ii) you will find that the initial system check will fail and you won't be able to use the machine anyway.

There is no alternative to getting a defective disk drive fixed.

Hard Disk drive

If your system isn't responding as you think it should, then you might have a problem with the Hard Disk. However, it is possible that the problem lies elsewhere:

If you are trying to load Disk 2 and you receive the message:

Not ready error reading Drive C

then you probably haven't yet carried out the installation procedure in Part I of this guide. Until you have, the Hard Disk is NOT available for use.

If the computer seems to be ignoring the Hard Disk, claiming that it is an 'Invalid drive' - again, you may not have carried out the installation procedure in Part I of this guide. Remember - until you have, the Hard Disk is NOT available for use.

Getting one of the following messages means that you have a hardware fault of some description, and you should consult your dealer.

Hard Disk errors:

Fatal disk error

Disk reset failed

Disk diagnostics failed

Disk not ready

or: Hard Disk drive not ready

Disk recalibration failed

or: Hard Disk recalibration failure

Write sector buffer failed

Hard Disk controller failure

Error: Hard Disk I/O Error

Note: If you attempt to park a non-AMSTRAD Hard Disk, you will receive the following message:

Invalid drive specification

VII.5 Trouble with a printer

The following covers the problems most commonly experienced with printers. Generally the place to look for advice is the printer's own manual.

- **You send data to the printer but it doesn't respond**

Check that the printer is on and on-line. Note: You often have to abandon the current printing and start again, if you switch a printer on-line after your PC has started sending data to the printer.

If you have a PC MD, try the command MDLST.

- **You send data to the printer and the printer head moves but nothing is printed**

Check that you have a ribbon in the printer.

- **You use the MS-DOS MODE command to change the number of characters per line (the pitch) or the number of lines per inch (the line pitch) but no change is seen in what the printer produces**

Check the printer's manual to see whether the printer can print different numbers of characters per line or lines per inch. The AMSTRAD DMP 1, for example, only has one possible line pitch.

- **You set up a document on your screen containing pound signs but when you print it, all the pound signs have been replaced, eg. by hashes**

Your computer and your printer are not using the exactly same character set. Look in the printer's manual to see if there is a setting on the printer that will give you pound signs (for example, the European IBM character set option on the AMSTRAD DMP3000).

VII.6 Trouble with the mouse

- **Moving the mouse has no effect on the pointer on the screen**

Check that the mouse cable is connected firmly to the mouse socket on the side of the PC System Unit.

If this doesn't restore the mouse and you are using GEM software, reset your PC by holding down the **Ctrl** and **Alt** keys and pressing the **Del** key. If the mouse still doesn't work, consult your dealer. In the short term, you should be able to continue working by pressing **Ctrl** and using the cursor keys.

If you are using a DOS program, you will be able to continue working by using the cursor keys. If you weren't able to use the mouse at all while using the program, use the NVR program to check what Mouse Movement Scaling has been set. If it has been set to zero, moving the mouse won't move the cursor. If you are running the program under MS-DOS, you might also check whether you have loaded the mouse driver MOUSE.COM (see Appendix I, Section I.6).

● **Clicking the mouse buttons doesn't have the expected effect**

Check that the mouse cable is connected firmly to the mouse socket on the side of the PC System Unit.

If this doesn't restore the mouse and you are using GEM software, reset your PC by holding down the **Ctrl** and **Alt** keys and pressing the **Del** key. If the mouse buttons still don't work, consult your dealer. In the short term, you should be able to continue working by pressing keys on the keyboard (see Part II, Chapter 10).

If you are using a DOS program, you will be able to continue working by using the keys on the keyboard. When the program has finished, use the NVR program to check what the mouse buttons have been set to – it could be that they haven't been set to what you expected. If you are running the program under MS-DOS, you might also check whether you have loaded the mouse driver MOUSE.COM (see Appendix I, Section I.6).

Note: Only use the MOUSE.COM supplied with your PC. This has been tailored specifically for the AMSTRAD PC.

VII.7 GEM messages

Most GEM messages are self-explanatory. If you are uncertain what action to take, look for message among this selection of less obvious messages and study the explanation given here.

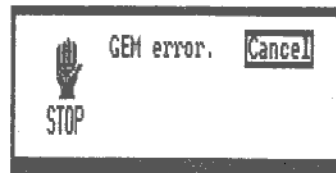

Fatal error. You may need to restart or reset your PC.

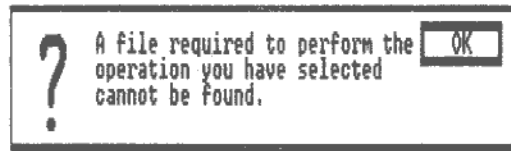

Check that the files you want to process are in a folder that is accessible to the program you want to run and that the program itself is accessible on the GEM Desktop before trying to carry out the task again.

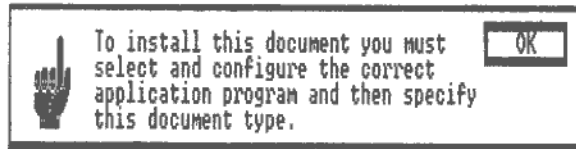

You have asked GEM to work on a document but you have not told it (via the Configuration procedure) which application program is to be used with this document. (See Part II, Section 3.2.)

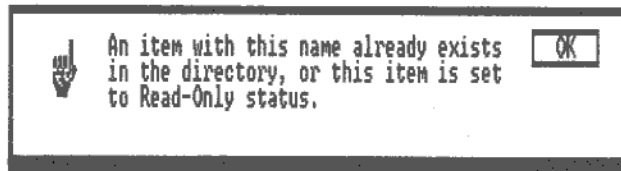

You are effectively trying to replace or delete an item in the directory which cannot be replaced or deleted, for example because you have made it Read-Only.

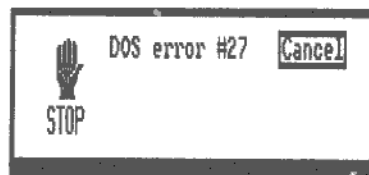

Your action has caused a system error. Check all details of the task you wanted to do before trying again.

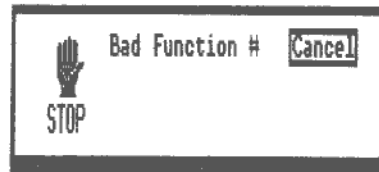

The program you are running contains an error. Check thoroughly before trying again.

VII.8 Disk and Device errors

Whenever a disk or device error occurs, the operating system displays a message of the form:

error READING|WRITING drive *n*:
Abort, Retry, Ignore?

error specifies the type of error that has occurred: the options are:

Bad call format error	Non-DOS disk error
Bad command error	No paper error
Bad media type	Not ready error
Bad unit error	Read fault error
Data error	Sector not found error
FCB unavailable	Seek error
General failure	Sharing violation
Invalid disk change	Write fault error
I/O error	Write protect error
Lock violation	

Type **[A]** to abandon the current command or program; type **[R]** to tell the operating system to try the action again; type **[I]** to tell it to move on to the next part of the task.

Note: The FCB error can usually be cured by changing the FCBS command in your CONFIG.SYS file.

VII.9 System messages

Most system messages are self-explanatory but what to do when others appear may not always be clear. If you are unsure, look for the error (or something very similar) in the following list and study the explanation given here.

Access denied

Your disk is probably write-protected.

Are you sure (Y/N)?

You have just told MS-DOS to erase all the files in a directory. Type **Y** if you want all these files deleted; type **N** to abandon this command.

Attempted write-protect violation

The disk you are trying to format is write-protected.

Bad command or file name

The command cannot find the program you asked to run. Check that you typed its name correctly or the file is not in the directory you specified.

Bad or missing filename

The CONFIG.SYS file contains an invalid device name. Check the DEVICE command in the CONFIG.SYS file (see Section V.3).

Bad or missing Command Interpreter or Cannot Load CCP

The operating system cannot find the COMMAND.COM file. Reset your machine. If necessary, copy the COMMAND.COM file from your backup operating system disk onto your Startup disk.

Batch file *file-name* missing retry (Y/N)?

Your computer is in the middle of running a Batch file but the disk containing the Batch file has been removed from the drive. Re-insert the disk and then press any character key.

Cannot do binary read from a device

The **/B** option of the COPY command cannot be used where an Input Device is the source of the file. Either remove the **/B** option or replace it with **/A**.

Cannot open *file-name*

The operating system cannot find the specified file. Check your command.

Cannot recover . entry

The working directory is defective.

CHDIR .. failed, trying alternate method

The operating system was unable to move directly to a parent directory. It will try to get to the directory by starting at the root directory and working down the directory tree.

COM port does not exist

You have specified an invalid COM port.

Content of destination lost before copy

A file to be used as a source file to the COPY command has been overwritten prior to the copy being made.

Convert lost chains to files (Y/N)?

If you type **Y**, CHKDSK will recover the lost blocks it found while checking the disk and store them in files. If you type **N**, the lost blocks are deleted.

Copy not completed

DISKCOPY was unable to copy the entire disk.

Corrections will not be written to disk

CHKDSK has found errors on the disk but won't fix any of these as you didn't select the /F option.

Directory is joined

The command cannot process directories that have been joined with the JOIN command.

Directory is totally empty, no . or ..

The directory does not contain entries for the working and the parent directory. Delete the directory and then recreate it.

Disk error reading FAT n

OR **Disk error writing FAT n**

One of your File Allocation Tables is damaged. You are advised to copy your files onto another disk.

Disk full. Edits lost

There was insufficient room on the disk for EDLIN to save your edited file. You will have to edit the file again.

Disks must be the same size

DISKCOPY can only copy a disk if the target disk can be given the same format as the source disk. You can, however, use the COPY command to copy the files across one by one.

Disk Read/Write Error

Your disk has been corrupted or damaged. You are advised to copy what files you can onto another disk and then try reformatting the disk.

Disk unsuitable for system disk

The disk is damaged in the area set aside for the system files. The disk can't be used as a startup disk but can be used for storing programs and data.

#

Divide error
or **Divide overflow**

The hardware divide overflow flag has been set. The probable reason for this is that your program file has become corrupted, causing it to execute random code.

Duplicate file name

A file with the filename you chose already exists.

Entry error

The last EDLIN command you typed contains a syntax error. Redo the command.

Entry has a bad attribute|link|size

CHKDSK has found a damaged part of the directory tree.

ERROR: Diskette is full

There is insufficient room on the disk to save your file.

Error in .EXE file

The .EXE file you asked the operating system to load has an invalid internal format

Errors on list device indicate that it may be off-line. Please check it

Your printer isn't turned on.

Error writing to device

You tried to send too much data to your Output Device.

EXEC failure

The operating system either found an error while reading an internal command or the number of open file handles has been set too low. Check the FILES command in the CONFIG.SYS file (see Section V.3).

fc: out of memory

COMP does not have enough memory to perform the comparison.

File allocation table bad

Your disk may be damaged. Run CHKDSK with the /F option to fix the disk.

File creation error

Either a file already exists with the name you chose and it cannot be replaced (eg. because it is a Read-Only file) or your disk may be damaged.

File not erased

The file you told the operating system to erase is write-protected.

File not found

MS-DOS cannot find the file you specified. Check your command and that the file you want is in the directory you specified.

FIRST diskette bad or incompatible

DISKCOMP failed to recognise the format of the source disk. Run CHKDSK to find out what the problem is.

For cannot be nested

You may not nest FOR commands in a Batch file.

Format not supported on drive n:

You cannot use the FORMAT command to format this drive.

Illegal device name

The operating system does not recognise this device name.

Illegal wildcard

The file name template you gave is invalid.

Incompatible system size

The system files cannot be copied because they need more space than is available on the destination disk.

Incorrect DOS version

You are using a version of MS-DOS that doesn't support this command.

Incorrect number of parameters

or **Invalid number of parameters**

You put either too many or too few parameters in the command line.

Insert diskette with batch file and press any key when ready

Your computer is in the middle of running a Batch file but the disk containing the Batch file has been removed from the drive. Re-insert the disk and then press any character key.

Insert DOS disk in drive n: and press RETURN when ready

The drive does not contain the MS-DOS system files you have asked to copy by selecting the /S option of the FORMAT command. Insert your MS-DOS startup disk in the specified drive and then press

Insert FIRST diskette in drive n:

Insert the disk you want DISKCOMP to compare another disk against. Press any character key when ready.

Insert new diskette for drive n: and press RETURN when ready

Insert the disk you want to format. Press when ready.

Insert SECOND diskette in drive n:

Insert the disk you want DISKCOMP to compare with your original disk. Press any character key when ready.

Insert target diskette into drive n:

Insert the disk you want DISKCOPY to store the copy on in the specified drive. Press any character key when ready.

Intermediate file error during pipe

An error has occurred in one of the temporary files created when information is piped from one program to another.

*

Invalid COMMAND.COM

The program you have just run used up almost all the available memory, overwriting the transient part of the COMMAND.COM file. The COMMAND.COM file has to be re-read from disk.

Invalid device

The device specified was not **CON**, **NUL**, **AUX** or **PRN**.

Invalid directory

or **Invalid sub-directory entry**

The directory you specified either doesn't exist or is invalid. Check that you entered the directory name correctly.

Invalid drive in search path

or **Illegal drive in Path specification**

A drive specified in the search path does not exist.

Invalid option

or **Invalid parameter**

One of the options you specified is wrong.

**Invalid path, not directory
or directory not empty**

RMDIR was either unable to find the directory you wanted to delete or the directory still contained files and/or subdirectories.

Invalid working directory

Your disk is damaged.

Line too long

Searching and replacing in EDLIN caused a line to expand beyond 253 characters. Divide the line in two and then retry the Replace command.

LPTn: not redirected

Usually means that you have just specified the settings of this printer device and you haven't told MS-DOS to redirect the printer output to a Serial port. Occasionally, it will indicate that the MODE command was unable to redirect the parallel printer port. Check that you specified the right printer options.

Memory allocation error

Reset your PC. If this error persists, make a new startup disk.

No free file handles

Reset your PC. If this error persists, increase the number of open file handles specified by the FILES command in the CONFIG.SYS file (see Section V.3).

Non-system disk or disk error

Either the disk is not a startup disk or the disk is damaged. Try another startup disk.

No room in directory for file

EDLIN was unable to save your edited file because the directory is full. Try saving the file in one of the other directories on the disk.

No system on default drive

SYS cannot copy the system files to the target disk because the disk in the default drive does not contain these files. Replace the disk with your MS-DOS startup disk and try again.

Not enough memory

There is insufficient memory to run the command.

Out of environment space

There is no room for further environment strings (see the SET command).

Parameters not compatible

The options you have selected can't be used together.

Probable non-DOS disk. Continue (Y/N)?

The disk you are using is not recognised by MS-DOS. Do not continue processing with CHKDSK.

Processing cannot continue

Insufficient memory for the current task.

Read error in filename

The operating system could not read this file.

SECOND diskette bad or incompatible

DISKCOMP could not recognise the format of the target disk for the comparison. Use CHKDSK to help you find out what the problem is.

Specified drive does not exist, or is non-removable

The command cannot work with the drive you specified (eg. because it doesn't exist).

Syntax error

Check you have typed the command correctly.

Too many files open

Insufficient file handles to open another file. Increase the number of open file handles specified by the FILES command in the CONFIG.SYS file (see Section V.3).

Track 0 bad — disk unusable

The disk is damaged in track 0, making it impossible to format. Use another disk.

Unable to create directory

You probably specified a name that is already used either by another sub-directory of the same parent directory or by a file in this directory. Alternatively, the disk may be full.

Unable to MOVE files use COPY

Your RENAME command gave a different drive in specifying the new file name to that used to specify the old file name. The file was not renamed. Re-do your command line.

Appendix VIII: USING GEM PAINT



GEM Paint is a sophisticated GEM based electronic painting program.

PAINT files are of type .IMG, although a .GEM file is also associated with each image. If you wish to open the image directly, always open the .IMG file.

The various tools available in GEM Paint are displayed to the left of the screen, and a selection of patterns is shown to the right. It is possible for GEM Paint to operate in two windows, with two different pictures, although memory restrictions may limit the size of picture displayed. Desktop accessories are available via the PAINT menu.

GEM Paint constructs the final picture by a combination of line or shape drawing, filling and text. There are also tools available for moving and copying sections of the picture and for magnifying a small area in order to inspect or modify the detail of individual pixels. The tools palette is used to select which operation is currently being performed. The Menu Bar options offer further functionality.

The **File menu** provides the normal facilities to load and **Save (Open or Close)** pictures, via item selectors, as well as the possibility to **Abandon** the changes made this session and to **Quit PAINT** - returning to the Desktop.

The **Tools menu** has a number of useful options. One allows the user to choose the **Shape** of the paint brush, paint sprayer or eraser. Another to **Show** or **Size** the painting surface. **Grid** helps by forcing filled shapes to snap to precise sizes (holding down the  key or right-hand mouse button while selecting areas or drawing filled shapes forces them to be precisely circular, square or straight) and **Transparent** defines the way in which a filled or moved pattern overwrites the existing screen contents. Pressing  or selecting **Undo** removes whatever you have just painted. Double clicking the paint brush, or paint sprayer, tools is a short-cut to selecting their shape, whilst double clicking the eraser clears the screen (Without any further warning!!)

Drawing is performed by dragging the pointer. Simplest amongst the tools are the paint brush, paint sprayer, pencil, line drawer and eraser. Note that the colour of the pencil and line are both set by the colour palette near the lefthand bottom corner of the screen, but that the thickness of the pencil is not affected by the nearby line palette. The 'trail' left by the paint brush and paint sprayer is chosen from the Pattern Palette and shown in the Current Pattern box at the top of the Pattern Palette.

Patterns can be loaded, saved and edited through the **Patterns menu** which also has the capability of copying a selected area from the picture into the Pattern Palette. Patterns may also be **Hidden** or **Shown** on the right hand side of the screen. Editing patterns employs a similar technique to using the Microscope tool. Notice, particularly when making or editing patterns, that the pattern is repeated twice in the area shown in the pattern palette and is repeated many times in the area shown as the current palette. No pattern files are provided with the AMSTRAD PC but the sample pictures incorporate a default set of patterns.

After selecting the Microscope tool whatever position in the main picture is clicked on is then shown much magnified. Having chosen a suitable colour from the palette it is then possible to change individual pixels in the picture by either clicking or dragging the pencil pointer. The part of the screen being shown magnified can be altered by either the normal scroll-bar technique, or by dragging the small box within the box immediately above the palette. The upper box shows a normal-size view of the selected part of the screen. To return to normal painting click on that box.

The Selector tool (Dotted Rectangle) marks out an area of the screen with a rubber rectangle. This can then be moved, copied or used to create a pattern. Having released the mouse button the pointer changes to a hand which can then be used to drag the selected area. Normally the selected area is copied (repeatedly if the Space bar is pressed before moving to the new location) but it can be moved if **Ctrl** is held down while dragging the selected area. The **Selector menu** provides additional operations that can be performed on the selected area. Double-clicking on the Selector tool is a short-cut to select the entire screen.

Geometric shapes can be drawn in a line whose colour and thickness has been specified by the colour and line palettes. When completed it is filled with the current pattern. Rectangles, Squares, Circles, Arcs, Rounded Boxes, Polygons and Free Forms are constructed with rubber images. Polygons are drawn by dragging rubber lines, clicking the mouse button at each corner and double clicking when completed. Free Form is achieved by simply dragging the pointer.

The Fill tool (Tap) fills an enclosed area with the current pattern. Even the slightest gap in the boundary will cause the fill to 'leak'. The fill stops when it encounters pixels of a different colour, therefore it will only be effective on areas of plain colour. Beware that some 'stipple' patterns may appear on the screen to be a plain colour but are in fact a pattern of interlinked pixels of different colours. If in doubt, check by using the Microscope tool.

Finally, text can be entered with the Text tool. The cursor is positioned by double-clicking the pointer and errors can be corrected by the **<Del** key. The text appearance can be changed from the **Font and Style menus**, with any alterations applying to all text since the last **←** key press.

The sample image supplied on Disk 4 is Black and White only. It will therefore load into GEM Paint correctly on any version of the PC1640. Note, however, that before using this bit-mapped image with any application other than Paint (eg. Output) it should be loaded into GEM Paint and then saved. The 'Save as...' option can be selected as soon as the image has been loaded.

Disk 4 contains a selection of fonts for use with CD, ECD and MD displays.

To obtain a fuller range of fonts:

- **If you only require to operate with MD or ECD 350 line resolution then delete AMSL*. * and replace with AMSHTR07.FNT, AMSHTR10.FNT and AMSHTR18.FNT from Disk 3.**

-
- **If you only require to operate with CD or ECD 250 line resolution then delete `AMSH*.*` and replace with `AMSLTR*.*` from Disk 3.**

Disk 3 contains a copy of all the display fonts supplied with your PC1640. Disk 4 contains all the print fonts supplied with your PC1640, plus a small selection of display fonts – as space permits.

Appendix IX: THE AMSTRAD PC SYSTEM DISKS

The following catalogues the files stored on each of the four disks supplied with your AMSTRAD PC and explains the use each file has – to help you know which files to have on the disk or disks you intend to use for any particular job.

Disk 1: MS-DOS Startup and Utilities

		Running MS-DOS	Running GEM software	GEM Desktop	Creating GEM pictures	Printing/displaying pictures	Running BASIC2
Root Directory							
IO.SYS MSDOS.SYS	} The MS-DOS operating system software (hidden files)	✓					
COMMAND.COM	The MS-DOS internal commands						
ANSI.COM ANSI.SYS CONFIG.SYS DRIVER.SYS GRAFTABL.EXE GRAPHICS.EXE KEYBUK.EXE MDGRAPH.COM MDLST.COM MODE.EXE MOUSE.COM RAMDRIVE.SYS RTC.COM	} System configuration files (see Section V.3)	✓					
AUTOEXEC.BAT GEM.BAT	The startup procedure	✓					

	Running MS-DOS	Running GEM software	GEM Desktop	Creating GEM pictures	Printing/displaying pictures	Running BASIC2
\GEMSTART Folder DISPCHK.COM GEM.BAT GEM2.BAT NVRPATCH.EXE		✓				
APPEND.COM ASSIGN.COM ATTRIB.EXE BACKUP.EXE ✓ CHKDSK.EXE COMP.EXE DEBUG.EXE DISKCOMP.EXE DISKCOPY.EXE EXE2BIN.EXE EDLIN.EXE FDISK.EXE FIND.EXE FORMAT.EXE GRAFTABL.EXE GRAPHICS.EXE JOIN.EXE KEYBUK.EXE LABEL.EXE MODE.EXE						
Programs that control the loading of the GEM software						
The MS-DOS external commands See Part III, Chapters 4-8 <i>HAVE ON DISK</i>		✓				

	Running MS-DOS
	Running GEM software
	GEM Desktop
	Creating GEM pictures
	Printing/displaying pictures
	Running BASIC2
<p>MORE.COM PRINT.EXE REPLACE.EXE RESTORE.EXE SORT.EXE SUBST.EXE SYS.COM TREE.EXE XCOPY.EXE</p> <p>} The MS-DOS external commands See Part III, Chapters 4 - 8</p> <p style="text-align: center;"><i>HAVE ON DISK</i></p>	✓

Disk 2: GEM Startup

	Running MS-DOS	Running GEM software	GEM Desktop	Creating GEM pictures	Printing/displaying pictures	Running BASIC2
Root Directory DISPLAY.COM } Programs that control the loading of the GEM GEM.BAT } software		✓				
\GEMSTART Folder ASSGNTST.COM } Special files that are used to configure the GEM DRVCNT.COM } software to your machine. TWODISKS.INF } MAKEGEM.BAT } GEMSTART.BAT } GEM3.BAT }						
\GEMBOOT Folder GEM.EXE } The GEM software GEM.RSC }		✓	✓	✓	✓	✓
CALCLOCK.ACC } The Desktop accessories SNAPSHOT } The Snapshot accessory. Rename SNAPSHOT to SNAPSHOT.RSC } SNAPSHOT.ACC and reload GEM to use			✓			

		Running MS-DOS	Running GEM software	GEM Desktop	Creating GEM pictures	Printing/displaying pictures	Running BASIC2
\GEMSYS Folder IBMEHMP6.SYS IBMCHMP6.SYS IBMEHFP6.SYS IBMEHFP6.SYS HERMONP6.SYS	Essential information about the screen		✓	✓	✓	✓	✓
MDMONO.ASS MDHERC.ASS CDCOLOR.ASS ECD350.ASS CDMONO.ASS ASSIGN.SYS	Essential information about which Input and Output devices you have		✓	✓	✓	✓	✓
GEMVDI.EXE	The GEM screen software		✓	✓	✓	✓	✓

Disk 3: GEM Desktop and BASIC 2

		Running MS-DOS	Running GEM software	GEM Desktop	Creating GEM pictures	Printing/displaying pictures	Running BASIC2
Root Directory							
RPED.EXE	Text editor program	✓		✓			
.DOODLE.APP } DOODLE.RSC }	Demonstration program				✓		
NVR.EXE	The program that sets the Battery-backed RAM	✓	✓				
\GEMAPPS Folder	Folder available for storing applications programs you buy		✓				
\GEMDESK Folder							
DESKTOP.APP } DESKTOP.INF } DESKTOP.RSC } DESKLO.ICN } DESKHI.ICN }	GEM Desktop software			✓			
\GEMSYS Folder							
FORMAT.EXE	Disk formatter program			✓			
METAFILE6.SYS	Post-processor for application output					✓	

		Running MS-DOS	Running GEM software	GEM Desktop	Creating GEM pictures	Printing/displaying pictures	Running BASIC2
AMSLSS10.FNT } AMSLTR10.FNT } AMSLSS14.FNT } AMSLTR14.FNT } AMSLSS18.FNT } AMSLTR18.FNT }	Font files each holding the pattern for a different style and size of text characters used on 200 line (CD) displays				✓	✓	✓
AMSHSS07.FNT } AMSHTR07.FNT } AMSHSS10.FNT } AMSHTR10.FNT } AMSHSS14.FNT } AMSHTR14.FNT } AMSHSS18.FNT } AMSHTR18.FNT } AMSHSS36.FNT } AMSHTR36.FNT }	Font files each holding the pattern for a different style and size of text characters used on 350 line (MD & ECD) displays					✓	
\BASIC2 Folder							
BASIC2.APP } BASIC2.RSC }	The BASIC 2 software						✓
DEMO.BAS	Demonstration program						

<p>\BASIC2\EXAMPLES Folder</p> <p>\BASIC2\PROGRAMS Folder</p>	<p>Example programs from the BASIC 2 User Guide</p> <p>Folder available for storing your own programs</p>						✓
		Running MS-DOS	Running GEM software	GEM Desktop	Creating GEM pictures	Printing/displaying pictures	Running BASIC2

Disk 4: GEM Paint and Output

		Running MS-DOS	Running GEM software	GEM Desktop	Creating GEM pictures	Printing/displaying pictures	Running BASIC2
\ GEMAPPS Folder							
PAINT.APP } PAINT.RSC } PAINT.HRS }	THE GEM Paint software				✓	✓	
\ GEMSYS Folder							
METAFIL6.SYS	Post processor for application output						
AMSLSS10.FNT } AMSLSS14.FNT } AMSLSS18.FNT } AMSHSS07.FNT } AMSHSS10.FNT } AMSHSS18.FNT }	200 Line Font Files holding the Pattern for a different style and size of text 350 Line				✓	✓	✓
OUTPUT.APP } OUTPUT.RSC } DEFAULT.OPT }	The software that displays and prints GEM pictures					✓	
EPSPMONH6.SYS	Essential information about printers compatible with the Epson Graphics printers					✓	

		Running MS-DOS	Running GEM software	GEM Desktop	Creating GEM pictures	Printing/displaying pictures	Running BASIC2
EPSHSS07.FNT } EPSHTR07.FNT } EPSHSS10.FNT } EPSHTR10.FNT } EPSHSS14.FNT } EPSHTR14.FNT }	Font files each holding the pattern for a different style and size of text characters used on the printer				✓	✓	✓
\IMAGES Folder TIGER.IMG } TIGER.GEM }	Programs containing a GEM Paint Picture				✓	✓	
\SUPPLEME Folder AUTOEXEC.BAT	The startup procedure for a Hard Disk system						
BEEP } CONFIG.BAT } CONFIG2.BAT } CONFIG3.BAT }	Programs used by the Hard Disk installation procedure	✓					

		Running MS-DOS	Running GEM software	GEM Desktop	Creating GEM pictures	Printing/displaying pictures	Running BASIC2
CONFIG.SYS	MS-DOS system configuration file	✓					
GEM.BAT	Program that controls the loading of GEM			✓			
HDFORMAT.COM	Program used to erase all the data from the Hard Disk			✓			
LINK.EXE	MS-DOS external command ✓	✓					
MSDOS.INF	Replacement DESKTOP.INF file for Hard Disk			✓			
NURPAT2.COM	Program used to reduce RAM disk drive to zero when operating GEM. This is advised in order to make most effective use of the available RAM						
PARK.COM	Programs used to park the Hard Disk read/write heads	✓					
RECOVER.EXE	MS-DOS external command ✓	✓					
SHARE.EXE	MS-DOS external command ✓	✓					

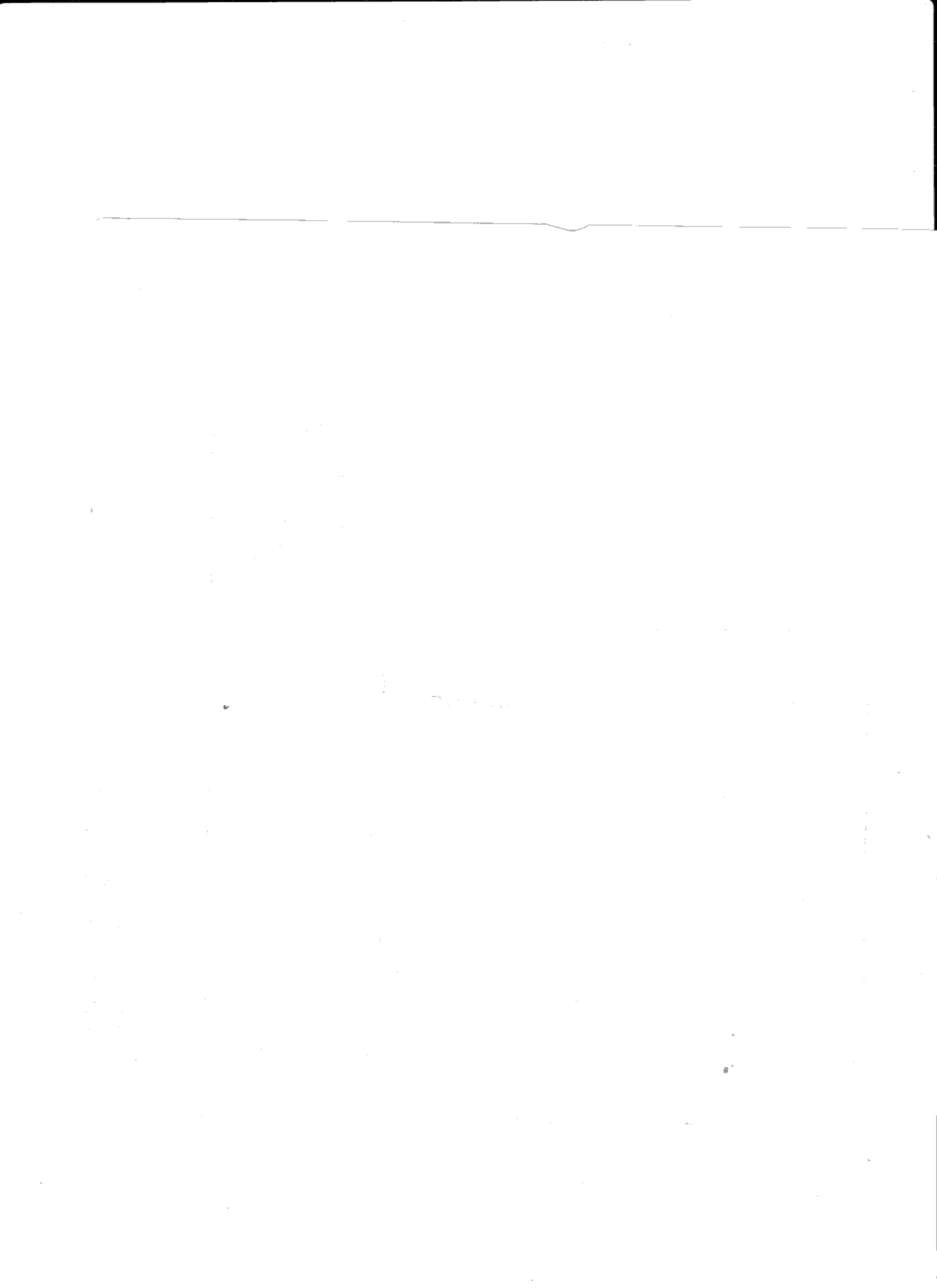

INDEX

- Active window, 131
 - New active window, 138
- AES (Application Environment Services), 509
- Alarm (Desktop clock), 179
- Alert boxes, 140
- AMSTRAD PC
 - Firmware, 459
 - Reference material, 459
 - ROM, 459
 - ROS (Resident Operating System), 459
 - Setting up your PC, 7
 - System Disks, 481
- ANSI screen codes, 439, 440
- ANSI.COM, 457
- ANSI.SYS, 440, 457
- APP files, 111
- APPEND, 253, **262**
- Archive attribute, 312, 314
- Arrange menu, 186
- ASSIGN, 246, **263**
- ASSIGN.SYS, 455
- ATTRIB, **294**, 312, **314**
- Attributes, 312, **314**
- AUTOEXEC.BAT, 261
- Back-up copies
 - AMSTRAD PC disks, 38
 - Files, 306, 311
- BACKUP command, **59**
- BAS files, 112
- BASIC 2
 - Advanced features, 409
 - Closing a window, 404
 - Colours menu, 394, **402**
 - Command summary, 405
 - Drawing shapes, 394
 - Edit menu, 400
 - Editing a program, 397, **400**
 - Failure to load, 389
 - File menu, 399
 - Fonts, 432
 - Fonts menu, 396, **401**
 - Function keys, **404**
 - Graphics screen, 396, 450
 - Leaving BASIC 2, 392
 - Line numbers, 397
 - Line styles, 394
 - Lines menu, **403**
 - Listing a program, 399
 - Loading BASIC 2, 67, 387
 - Opening a window, 404
 - Outputting text, 396
 - Patterns menu, **403**
 - Program menu, **399**
 - Reference material, 460
 - Renumbering a program, **400**
 - Running a program, 69, 387, 397, **399**, **453**
 - Saving a program, 399
 - Screen graphics, 408
 - Special keystrokes, 389
 - Stop and continue, 406
 - Stopping a program, 406
 - Syntax error, 397
 - Text screen, 396
 - Turtle graphics, 395, 409
 - Windows, 390
 - Windows menu, **404**
- Batch files, 257, **287**
 - Conditional commands, 258, **294**
 - Dummy parameters, 259
 - ECHO, 258, **289**
 - FOR, 258, **291**
 - GOTO, 258, **293**
 - IF, 258, **294**
 - Labelled points in a Batch file, **293**
 - Multi-purpose Batch files, 259
 - PAUSE, 259, **296**
 - REM, 258, **297**
 - Repeated commands, 258, **291**
 - Screen messages, 258, **289**, **297**
 - SHIFT, 259, **298**
 - What to include, 417
- Batch processing, 257, **287**
 - Stopping a Batch process, 260
- Batteries, 9
 - Changing, 426
 - Low power, 107
 - Renewal options, 426

*Bold page numbers give the start of the relevant reference section
Light page numbers give the start of the relevant descriptive section*

Battery-backed RAM, 9, 421
 NVR program, 422
 Supplied settings, 420
 Bleep, 15, 189
 BREAK, 251, **264**
 Brightness control, 15
 BUFFERS command, 456

 Calculator, 183
 Changing disks under GEM, 146
 Character keys, 36
 Character sets, 428
 Internal codes, 430, 432
 Keystrokes, 430
 CHDIR, 244, **265**
 Child directories, 155
 CHKDSK, 349, **350**
 Cleaning your PC, 115
 Clearing the screen, 247, **267**
 Clicking, 122
 Clock
 Setting operating system clock, 503
 Setting the alarm, 179
 Setting the date, 179, 364, **366**
 Setting the time, 179, 364, **378**
 Close box, 133
 Closing a window, 139
 Closing up a menu, 130
 CLS, 247, **267**
 Colours menu (BASIC 2), **402**
 COM files, 111
 COM1, COM2, 361, 372, 444
 Combining files using COPY, 308, **319**
 Command lines, 222
 Editing the command line, 249
 Command name, 222, 223
 Details of program location, 247
 Command summary
 BASIC 2, 405
 MS-DOS commands, 379
 Command tail, 222, 224
 COMMAND.COM, 347
 Communications links
 Setting up using MODE, 362, **372**
 COMP, 310, **316**
 Comparing disks, 349, **352**
 Comparing files, 310, **316**
 Computing fundamentals, 1
 CONFIG.SYS, 32, 456
 Contrast control, 16

 Conventions, 235
 COPY, 306, **319**
 Copy-protected programs, 415
 Copying disks
 Using GEM, 82, 174
 Using MS-DOS, 95, 348, **354**
 Copying files, 4
 From Input Devices, **299**, 306, **379**
 To Output Devices, 287, **299**, 306, **319**
 Using COPY, 98, 306, **319**
 Using GEM, 85, 164
 With confirmation (GEM), 189
 COUNTRY command, 456
 CTTY, 360, **365**
 Current directory, 242
 Changing the current directory, 244, **265**
 Cursor keys, 36

 DATE, 364, **366**, 359
 Setting the date, 20, 24, 29, 180, 364, **366**
 Date and time stamping
 DOS media, 311, 312
 Daughter directories, 155
 Default directory, 2
 Default drive, 2, 223
 DEL, **302**, 309, **322**
 Deleting files, 4
 Using GEM, 88, 167
 Using MS-DOS, 100, **302**, 309, **322**
 Without confirmation (GEM), 189
 Desktop accessories, 177
 Desktop menu, 177, **186**
 Device drivers, 455
 Device names
 Under MS-DOS, 444
 Dialog boxes, 140
 Changing data in Dialog boxes, 142
 Dialog box cursor, 141
 Entering information, 141
 Exit buttons, 140
 Principal exit button, 140
 Selecting a Dialog box option, 141
 Supplied characters, 141
 Text fields, 140
 Dialogue window (BASIC 2), 390
 DIR, 241, **268**
 Directories, 2
 Child directories, 155
 Creating a new directory, 303, **329**

Bold page numbers give the start of the relevant reference section

- Current directory, 242
- Daughter directories, 155
- Default directory, 2
- Directory names, 113
- Directory structure, 302
- Directory windows, 131
- Listing the directory, 241, **268**
- Listing using GEM, 156
- Parent directories, 155
- Removing a directory, 304, **338**
- Root directory, 2
- Sorted under GEM, 158
- Directory structure, 302
- Disk buffers
 - Number of buffers, 456
- Disk drives, 42
 - Adding an extra drive, 454
 - Troubleshooting, 461, 467
- Disk Housekeeping, 4
 - Using GEM, 81, 163
 - Using MS-DOS, 95, 286, 306
- DISKCOMP, 349, **352**
- DISKCOPY, 348, **354**
- Disks
 - Allocating disk space, 415
 - Changing disks, 56
 - Changing under GEM, 146
 - Comparing disks, 349, **352**
 - Copying using GEM, 82, 174
 - Copying using MS-DOS, 95
 - Disk labels, 55, 344, **347**, 363, **371**,
 - Formatting using GEM, 84, 173
 - Formatting using MS-DOS, 97, 347, **355**
 - Free space, 91, 103, 162, 310
 - Handling and storage, 55
 - Inserting a disk, 56
 - Reading window, 54
 - Releasing a disk, 57
 - Tracks and Sectors, 53
 - Type of disks, 53
 - Verifying using MS-DOS, 350, **351**
 - Write-protect notch, 54
 - Write-protecting, 54
- Display selector switches, 10, 434
- DISPLAY command, 437
- Documents, 2
 - Size of, 161
- DOODLE
 - DOODLE program facilities, 50
 - Leaving DOODLE, 52
 - Running the DOODLE program, 46
- DOS, 1
- DOS partitions, 30, 62, **367**
- DOS programs, 65
 - Running from the Desktop, 74, 75, 153
 - Running under MS-DOS, 78
 - *Two-disk programs, 78
 - Using a joystick, 419
 - Using a mouse, 419
- Double-clicking, 122
- Dragging, 104, 110, 122, 128
- Dummy parameters, 298
- ECHO, 258, 289
- Echoing to the printer, 251
- Edit menu
 - BASIC 2, 400
 - GEM Output, 215
- Edit window (BASIC 2), 390
- Editing files, 4, 92, 104, 306, **324**
- Editing the command line, 249
- EDLIN, **324**
- EDLIN commands, **325**
- Environment parameters, 229, 241, **261**
247, 259, **281**
- ERASE, 309, **322**
- Erasing files
 - Using GEM, 88, 167
 - Using MS-DOS, 100, 309, **322**
- Error messages
 - Dialog boxes, 140
 - GEM programs, 466
 - Hardware, 474
 - Input and Output Devices, 467
 - Operating system, 468
- EXE files, 111
- Expansion boards
 - Installing, 449
- External commands, 219
- FCBS command, 456
- FDISK, 29, **367**
- File menu
 - BASIC 2, **399**
 - GEM Desktop, **185**
 - GEM Output, **194**
- File name templates, 112
- File names, 111
- File organisation, 242

Light page numbers give the start of the relevant descriptive section

- Files, 2
 - Attributes, 292, **294**, 312, **314**
 - Combining files using COPY, 288, **299**, 308, **319**
 - Comparing files, 290, **296**, 310, **316**
 - Copying using COPY, 98, 306, **319**
 - Copying using GEM, 70, 85, 146, 164
 - Date and time stamping (DOS media), 312
 - Deleting using GEM, 88, 167
 - Deleting using MS-DOS, 100, 309, 322
 - Editing, 92, 104, **304**, 306, **324**
 - Erasing using GEM, 88, 167
 - Erasing using MS-DOS, 100, 309, **322**
 - Illegal file names, 111
 - Listing, 308, **342**
 - Moving, 306
 - Number of open files, 456
 - Printing, 308, **331**
 - Read-Only files, 170, 292, **294**, 312, **314**
 - Read-Write files, 152, 170, 292, **294**, 312, **314**
 - Renaming using GEM, 90, 168
 - Renaming using MS-DOS, 101, 309, **335**
 - Size of, 91, 102, 161, 241
 - Specifying a group of files, 112
 - Time and date stamping (DOS media), 312
 - Valid filenames, 111
 - Write-protecting, 170, 312, **314**
- FILES command, 456
- Filters, 255
- FIND, 237, **252**, 255, **270**
- Fitting the mains plug, 8
- Flow control, 425
- Folders, 2
 - Copying folders, 164
 - Deleting folders, 167
 - Displayed as icons, 156
 - Displayed as text, 156
 - Folder names, 113
 - Making use of folders, 155
 - Moving from one to another, 155
 - New folders, 156
- Fonts, 428, 432, 455
 - BASIC 2 Fonts menu, **401**
- FOR, 258, **291**
- Form statements, 222
- FORMAT, 347, **355**
- Formatting disks
 - Using GEM, 84, 173
 - Using MS-DOS, 97, 347, **355**
- Free space, 310
- Full box, 133
- Function keys, 36
 - In BASIC 2, **404**
- GEM, 1, 65, **117**
- GEM Desktop, 118
 - How to use, 118
 - Initial features, 189
 - Loading GEM Desktop, 20, 107
- GEM Output, 193
 - Camera, 209
 - Changing Output Lists, 203
 - Flow of program, 197
 - Leaving GEM Output, 214
 - Plotter, 208
 - Print in the background, 208
 - Printer, 208
 - Saving device settings, 212
 - Saving Output Lists, 205
 - Screen, 207
 - Setting up Output Devices, 207
 - Setting up Output Lists, 199
 - Start output, 213
 - Using saved device settings, 212
- GEM Paint, 71
 - Changing an existing picture, 71
 - Leaving GEM Paint, 73
 - Menus, 477
 - Running GEM Paint, 71
 - Starting a new picture, 71
 - Tools, 477
 - Using GEM Paint, 477
- GEM programs, 65
 - Configuring a program, 149
 - Document types, 150
 - Error messages, 466
 - Failure to load, 462
 - Installing programs, 150
 - Possible problems, 73
 - Running GEM programs, 73, 152
 - Swapping disks, 73
- GEM.BAT, 261
- GOTO, 258, **293**
- GRAPHICS, 252, **272**
- Graphic display options, **433**, 451, 452, 453
- Hard Disk
 - Operation, **26**, 57
 - Moving, 63
- Hardware, 1
 - Error messages, 474

- Reference material, 460
- HDFORMAT, 30
- Hexadecimal numbers, 428
- Hour-glass, 122
- IBM PC disks and the AMSTRAD PC, 65
- Icons, 122
 - Dragging an icon, 128
 - Icon pictures, 122, 150
 - Opening an icon, 127
 - Selecting icons, 124
- IF, 258, **294**
- Illegal file names, 111
- Imaginary drives, 245
- Initial screen colours, 425
- Initial screen mode, 425
- Input and Output Devices, 1
 - Error messages, 467
 - Setting up using MODE, 359, **372**
- Inserting a disk, 56
- Installing programs, 415
- Interfaces, 1
- Internal commands, 219
- IO.SYS, 347
- Item Selector, 143
 - Changing which folder is displayed, 144
 - Making your selection, 145
- JOIN, 246, **274**
- Joystick
 - Connecting to keyboard, 13, 453
 - Setting fire buttons, 424
 - Types of joystick, 453
 - Using with DOS programs, 418
- Key codes, 442
- Keyboard, 36, 442
 - National keyboards, 458
 - Troubleshooting, 463
- KEYBUK, 458
- LABEL, 363, **371**
- Leaving BASIC 2, 392
- Leaving GEM, 146, 148
- Leaving GEM Paint, 73
- Line styles
 - BASIC 2 Lines menu, **403**
- Listing a file, 342
- Loading BASIC 2, 67, 387
- Loading GEM Desktop, 20, 107
- Loading MS-DOS, 107, 220
- Logging-in a new disk, 146
- LPT1, LPT2, LPT3, 361, 372, 444
- Menus, 129
 - Closing up, 130
 - Options in dark script, 129
 - Options in light script, 129
 - Pulling down a menu, 130
 - Selecting an option, 130
 - When to click mouse button, 50
 - ◆ character, 130, 131
- MDGRAPH, 276
- MDLST, 447
- MKDIR, 303, **329**
- MODE, 361, **372**
- Monitor, 433
- MORE, 254, **278**
- Mouse
 - Alternatives to using the mouse, 217
 - Disabling the mouse, 419
 - Mouse movement scaling, 424
 - Moving the pointer, 34
 - Setting mouse buttons, 424
 - Speed of click, 189
 - Suitable surface, 34
 - Troubleshooting, 465
 - Using with DOS programs, 419
- Mouse buttons
 - Clicking, 122
 - Double-clicking, 122
 - Dragging, 122
 - Shift-clicking, 123
- MS-DOS, 65, 219, 227
 - Loading MS-DOS, 220
- MSDOS.SYS, 347
- Name conflicts, 88, 169
- New disks, 53
 - Preparing for use using GEM, 84, 173
 - Preparing for use using MS-DOS, 97, 347
- New Folders, 156, 163
- NUL, 319
- NVR program, 422
- Opening a disk, 127
- Opening a folder, 127
- Opening an icon, 127
- Operating systems, 1
 - Error messages, 468
 - Reference material, 460
 - Setting operating system clock, 458
 - Version number, 241, 285
 - Which to choose, 414
- Options menu
 - GEM Desktop, **185**

Light page numbers give the start of the relevant descriptive section

#

v

- GEM Output, **214**
- Output lists, 199
- OUTPUT.APP, 193
- Outputting text (BASIC 2), 396
- Parallel Printer Port
 - Pin-out, 445
 - Setting up using MODE, 362, **372**
 - Timing diagram, 447
 - Using the port, 445
- Parent directories, 155
- PARK command, 64
- PATH, 253, **279**
- Paths, 224, 242
 - From the Current directory, 115, 244
 - From the Root directory, 114, 243
 - Specifying a path, 114
- Patterns menu (BASIC 2), **403**
- PAUSE, 259, **296**
- PC-DOS, 65
- Peripherals, 1
- Piping, 255
- Placeholders, 224, 235
- Pointer, 34, 122
 - Bringing back on the screen, 34
 - Moving with the mouse, 34
 - Moving with the keyboard, 217
- Ports, 1, 445
- Post-processing output, 255
- PRINT, 308, **331**
- Print Spooler, 216
- Printer
 - Connecting to your PC, 14
 - Setting up using MODE, 362 **372**
 - Troubleshooting, 465
- Printer cable, 445
- Printer character set, 445
- Printer device driver, 445
- Printing in the background
 - Using GEM, 216
 - Using MS-DOS, 308, **331**
- PRN, 444
- Program filetypes, 239
- Program menu (BASIC 2), 399
- Program parameters, 75
- Programs for the AMSTRAD PC, 65, 413
- PROMPT, 363, **376**
- RAM, 1
- RAM disk
 - Setting the size of RAM disk, 424
- Read-Only files
 - Under MS-DOS, 312, **314**
 - Using GEM, 170
- Read-Write files
 - Under MS-DOS, 312, **314**
 - Using GEM, 170
- Redirecting
 - Disk searches, 246, **263, 274**
 - Piping, 255
 - Printer output, 361, **372**
 - Standard input, 254
 - Standard output, 255
- Reference material, 459
- REM, 258, **297**
- Removing a directory, 304, **338**
- RENAME, **335**
- Renaming files, 4
 - Using GEM, 90, 168
 - Using MS-DOS, 101, 309, **335**
- REPLACE, 311, **336**
- Reserved file names, 111
- Resetting your PC, 110
- Results-1 window (BASIC 2), 404
- Results-2 window (BASIC 2), 404
- RESTORE command, 61
- Returning to the Desktop, 73, 76, 77, 146, 148, 154
- RMDIR, 304, **338**
- RPED program
 - Under GEM, 92
 - Under MS-DOS, 104
- RTC.COM, 458
- Rubber rectangle, 125, 217
- Running programs
 - A BASIC 2 program, 387
 - BASIC 2, 67
 - Batch files, 257, 287
 - DOS programs from GEM, 74, 152
 - DOS programs under MS-DOS, 77, 247
 - GEM Paint, 70
 - GEM programs, 73, 152
 - Possible problems, 73, 225
 - Stopping a program, 251, 264
 - Troubleshooting, 462
 - Turnkey programs, 78
 - Types of program, 239
 - Using GEM Desktop, 73, 152
 - Using MS-DOS, 247
- Saving the Desktop, 191
- Screen
 - Adjusting screen display, 362, **372**

Bold page numbers give the start of the relevant reference section

- Screen dumps, 252, **272**
- Screen handling
 - Under MS-DOS, 433
- Screen messages (Batch files), 258, **289, 297**
- Scroll bars, 133
- Search paths
 - Data files, 253, **262**
 - Program files, 252, **279**
- Selecting icons, 124
- Serial Interface
 - Cabling, 448
 - Setting the parameters, 425, 448
 - Using the port, 448
- Serial printer
 - Setting up using MODE, 361, **372**
- SET, 247, **281**
- Setting up your PC, 7
- SHIFT, 259, **298**
- Shift-clicking, 122
- Single-drive systems
 - Running two-disk programs, 246
- Size box, 133
- Sizes of files
 - Displayed using GEM, 91
 - Displayed using MS-DOS, 102
- Snapshot, 177
- Software, 1
- SORT, 255, **283**
- Startup disk
 - Which to choose, 414
- Startup procedure, 107
 - Troubleshooting, 461
- Stop and continue (BASIC 2), 406
- Stopping a Batch process, 260
- Stopping a program, 251, 264
 - BASIC 2, 406
- Storage space on disk
 - Displayed using GEM, 91
 - Displayed using MS-DOS, 103
- SUBST, 245, **284**
- Switching off, 110
- Switching on, 107
- Syntax error (BASIC 2), 397
- Syntax statements, 222
- SYS, 348, **357**
- System disks, 481
 - Updating, 357
- System prompt, 222, 223
 - Special prompt, 363, **376**
- Text editor, 92, 104, 306, 324
- Text fields, 140
 - Changing data in text fields, 142
 - Moving to different text field, 142
- TIME, 364, **378**
 - Setting the time (GEM), 179
- Time and date stamping
 - DOS media, 312
- Title bar, 132
- TREE, 302, **340**
- Troubleshooting, 461
- Turnkey programs, 78
 - Running Turnkey programs, 78
 - Setting up, 417
- Turtle graphics
 - Displaying the turtle, 395
- Turtle graphics (BASIC 2), 395, 409
- TYPE, 308, **342**
- Updating system files, 357
- Using GEM to run programs, 152, 153
- Using your PC from a terminal, 360, **365**
- V-Hold knob, 16
- VDI (Virtual Device Interface), 459
- VER, 240, 285
- VERIFY, 248, **286**
- Verifying
 - Data written to disk, 248
 - Disks using MS-DOS, 349, **350**
- Virtual screen, 131
- VOL, 344
- Volume control, 16
- Wildcards, 111
- Windows, 131
 - Active window, 131
 - Application windows, 131
 - BASIC 2 windows, 390
 - Changing the size of windows, 134
 - Close box, 133
 - Closing a window, 139
 - Closing a window (BASIC 2), 404
 - Directory windows, 131
 - Full box, 133
 - Moving a window, 135
 - New active window, 138
 - Opening a window (BASIC 2), 404
 - Scroll bars, 133

Light page numbers give the start of the relevant descriptive section

Scrolling a window, 136
Size box, 133
Title bar, 132
Windows menu (BASIC 2), **404**
Write-protecting floppy disks, 39, 54
Write-protection
 Under GEM, 170
 Under MS-DOS, 312, **314**

XCOPY, 306, **345**

Alt	, 36, 38
Esc	, 37, 38
Ctrl	, 36, 38
Del	, 37
End	, 37
Enter	key Setting, 424
Home	, 37
Ins	, 37
Num	, 20, 22, 37, 38
Prt Sc	, 252
Del▶	key Setting, 424

*Bold page numbers give the start of the relevant reference section
Light page numbers give the start of the relevant descriptive section*

Digital Research and AMSTRAD END USER PROGRAM LICENCE AGREEMENT

NOTICE TO USER – PLEASE READ THIS NOTICE CAREFULLY. DO NOT OPEN THE DISKETTE PACKAGE UNTIL YOU HAVE READ THIS LICENCE AGREEMENT.

OPENING THE DISKETTE PACKAGE INDICATES YOUR AGREEMENT TO BE BOUND BY THESE TERMS AND CONDITIONS.

1. Definitions

In this Licence Agreement, the terms:

- 1 DRI means DIGITAL RESEARCH INC., Box DRI, Monterey, California 93942, owner of the copyright in, or authorised licensor of, the program.**
- 2 Machine means the single microcomputer on which you use the program. Multiple CPU systems require additional licences.**
- 3 Program means the set of programs, documentation and related materials in this package, together with all ancillary updates and enhancements supplied by DRI to you regardless of the form in which you may subsequently use it, and regardless of any modification which you make to it.**
- 4 AMSTRAD means AMSTRAD PLC., Brentwood House, 169 Kings Road, Brentwood, Essex CM14 4EF.**

You assume responsibility for the selection of the program to achieve your intended results, and for the installation, use and results obtained from the program.

2. Licence

You may

- 1 Use the program on a single machine.**
- 2 Copy the program into any machine readable or printed form for backup or modification purposes in support of your use of the program on a single machine.** You may make up to three (3) copies of the program for such purposes. (Certain programs, however, may include mechanisms to limit or inhibit copying. They are marked 'copy protected'). Copying of documentation and other printed materials is prohibited. Disassembly of code is prohibited.
- 3 Modify the program and/or merge it into another program for your use on the single machine.** (Any portion of this program merged into another program will continue to be subject to the terms and conditions of this Agreement).
- 4 Transfer the program and licence to another party if you notify DRI of name and address of the other party and the other party agrees to a)**

accept the terms and conditions of this Agreement, b) sign and forward to DRI a copy of the registration card and c) pay the then current transfer fee. If you transfer the program, you must at the same time either transfer all copies, including the original, whether in printed or machine readable form to the same party, or destroy any copies not transferred; this includes all modifications and portions of the program contained or merged into other programs.

You must reproduce and include the copyright notice on any copy, modification or portion merged into another program.

EACH DISKETTE IS SERIALISED, AND YOU MAY NOT USE, COPY, MODIFY, TRANSFER, OR OTHERWISE MAKE AVAILABLE TO ANY THIRD PARTY, THE PROGRAM, OR ANY COPY, MODIFICATION OR MERGED PORTION, IN WHOLE OR IN PART, EXCEPT AS EXPRESSLY PROVIDED FOR IN THIS LICENCE AGREEMENT.

IF YOU TRANSFER POSSESSION OF ANY COPY, MODIFICATION OR MERGED PORTION OF THE PROGRAM TO ANOTHER PARTY, YOUR LICENCE IS AUTOMATICALLY TERMINATED.

3. Term

The licence is effective until terminated. You may terminate it at any other time by destroying the program together with all copies, modifications and merged portions in any form. It will also terminate upon conditions set forth elsewhere in this Agreement or if you fail to comply with any term or condition of this Agreement. You agree upon such termination to destroy the program together with all copies, modifications and merged portions in any form.

4. Limited warranty

THE PROGRAM IS PROVIDED 'AS IS'. NEITHER DRI NOR AMSTRAD MAKE ANY WARRANTY OF ANY KIND, EITHER EXPRESSED OR IMPLIED, INCLUDING, BUT NOT LIMITED TO THE IMPLIED WARRANTIES OF MERCHANTABILITY AND FITNESS FOR A PARTICULAR PURPOSE. THE ENTIRE RISK AS TO THE QUALITY AND PERFORMANCE OF THE PROGRAM IS WITH YOU. SHOULD THE PROGRAM PROVE DEFECTIVE, YOU (AND NOT DRI OR AMSTRAD) ASSUME THE ENTIRE COST OF ALL NECESSARY SERVICING, REPAIR OR CORRECTION.

Neither DRI nor AMSTRAD warrant that the functions contained in the program will meet your requirements or that the operation of the program will be uninterrupted or error free.

However, AMSTRAD warrants the diskette on which the program is furnished, to be free from defects in materials and workmanship under normal use for a period of ninety (90) days from the date of delivery to you as evidenced by a copy of your receipt.

5. Limitations of remedies

AMSTRAD's entire liability and your exclusive remedy against AMSTRAD shall be the replacement of any diskette not meeting this 'Limited Warranty' and which is returned to AMSTRAD with a copy of your receipt.

IN NO EVENT SHALL DRI OR AMSTRAD BE LIABLE FOR ANY DAMAGES, INCLUDING ANY LOST PROFITS, LOST SAVINGS, OR OTHER SPECIAL INDIRECT OR CONSEQUENTIAL DAMAGES, EVEN IF DRI OR AMSTRAD HAS BEEN ADVISED OF THE POSSIBILITY OF SUCH DAMAGES, OR FOR ANY CLAIM BY ANY OTHER PARTY.

6. Registration card

DRI may from time to time update its programs. Updates will be provided to you only if a properly signed registration card is on file at DRI's main office or an authorised registration card recipient. DRI is not obligated to make any program updates, or to supply any such updates to you.

7. General

You may not sublicense, assign or transfer the licence or the program except as expressly provided in this Agreement. Any attempt otherwise to sublicense, assign or transfer any of the rights, duties, or obligations hereunder is void.

This Agreement shall be governed by and construed in accordance with the laws of England.

Should you have any questions concerning this Agreement, you may contact AMSTRAD by writing to Amstrad plc, Brentwood House, 169 Kings Road, Brentwood, Essex, CM14 4EF.

THIS AGREEMENT CANNOT AND SHALL NOT BE MODIFIED BY PURCHASE ORDERS, ADVERTISING OR OTHER REPRESENTATIONS BY ANYONE, AND MAY ONLY BE MODIFIED BY A WRITTEN AMENDMENT EXECUTED BY YOU AND AN AUTHORISED OFFICER OF DRI AND AMSTRAD.

YOU ACKNOWLEDGE THAT YOU HAVE READ THIS AGREEMENT, UNDERSTAND IT AND AGREE TO BE BOUND BY ITS TERMS AND CONDITIONS. YOU FURTHER AGREE THAT IT IS THE COMPLETE AND EXCLUSIVE STATEMENT OF THE AGREEMENT BETWEEN YOU AND DRI AND AMSTRAD WHICH SUPERSEDES ANY PROPOSAL OR PRIOR AGREEMENT, ORAL OR WRITTEN, AND ANY COMMUNICATIONS BETWEEN YOU AND DRI OR AMSTRAD RELATING TO THE SUBJECT MATTER OF THIS AGREEMENT.

THIS AGREEMENT DOES NOT AFFECT YOUR STATUTORY RIGHTS.

Microsoft Corporation and AMSTRAD END USER PROGRAM LICENCE AGREEMENT

NOTICE TO USER - PLEASE READ THIS NOTICE CAREFULLY. DO NOT OPEN THE DISKETTE PACKAGE UNTIL YOU HAVE READ THIS LICENCE AGREEMENT.

OPENING THE DISKETTE PACKAGE INDICATES YOUR AGREEMENT TO BE BOUND BY THESE TERMS AND CONDITIONS.

AMSTRAD provides this program and licenses its use. You assume responsibility for the selection of the program to achieve your intended results, and for the installation, use and results obtained from the program.

LICENCE

You may:

- 1 Use the program on a single machine;**
- 2 Copy the program into any machine readable or printed form for backup or modification purposes in support of your use of the program on a single machine.** (Certain programs, however, may include mechanisms to limit or inhibit copying. They are marked "copy protected".);
- 3 Modify the program and/or merge it into another program for your use on the single machine.** (Any portion of this program merged into another program will continue to be subject to the terms and conditions of this Agreement); and,
- 4 Transfer the program and licence to another party if the other party agrees to accept the terms and conditions of this Agreement.** If you transfer the program, you must at the same time either transfer all copies, including the original, whether in printed or machine readable form to the same party, or destroy any copies not transferred; this includes all modifications and portions of the program contained or merged into other programs.

You must reproduce and include the copyright notice on any copy, modification or portion merged into another program.

YOU MAY NOT USE, COPY, MODIFY OR TRANSFER, THE PROGRAM OR ANY COPY, MODIFICATION OR MERGED PORTION IN WHOLE OR IN PART, EXCEPT AS EXPRESSLY PROVIDED FOR IN THIS LICENSE AGREEMENT.

IF YOU TRANSFER POSSESSION OF ANY COPY, MODIFICATION OR MERGED PORTION OF THE PROGRAM TO ANOTHER PARTY, YOUR LICENCE IS AUTOMATICALLY TERMINATED.

TERM

The licence is effective until terminated. You may terminate it at any other time by destroying the program together with all copies, modifications and merged portions

in any form. It will also terminate upon conditions set forth elsewhere in this Agreement or if you fail to comply with any term or condition of this Agreement. You agree upon such termination to destroy the program together with all copies, modifications and merged portions in any form.

LIMITED WARRANTY

THE PROGRAM IS PROVIDED "AS IS" WITHOUT WARRANTY OF ANY KIND, EITHER EXPRESSED OR IMPLIED, INCLUDING, BUT NOT LIMITED TO THE IMPLIED WARRANTIES OF MERCHANTABILITY AND FITNESS FOR A PARTICULAR PURPOSE. THE ENTIRE RISK AS TO THE QUALITY AND PERFORMANCE OF THE PROGRAM IS WITH YOU. SHOULD THE PROGRAM PROVE DEFECTIVE, YOU (AND NOT AMSTRAD) ASSUME THE ENTIRE COST OF ALL NECESSARY SERVICING, REPAIR OR CORRECTION.

AMSTRAD does not warrant that the functions contained in the program will meet your requirements or that the operation of the program will be uninterrupted or error free.

However, AMSTRAD warrants the diskette(s) on which the program is furnished, to be free from defects in materials and workmanship under normal use for a period of ninety (90) days from the date of delivery to you as evidenced by a copy of your receipt.

LIMITATIONS OF REMEDIES

AMSTRAD's entire liability and your exclusive remedy against AMSTRAD shall be:

- 1 The replacement of any diskette not meeting AMSTRAD's "Limited Warranty" and which is returned to AMSTRAD with a copy of your receipt.**
- 2 If AMSTRAD is unable to deliver a replacement diskette which is free of defects in materials or workmanship, you may terminate this Agreement by returning the program and your money will be refunded.**

IN NO EVENT WILL AMSTRAD BE LIABLE FOR ANY DAMAGES, INCLUDING ANY LOST PROFITS, LOST SAVINGS OR OTHER INCIDENTAL OR CONSEQUENTIAL DAMAGES ARISING OUT OF THE USE OR INABILITY TO USE SUCH PROGRAM EVEN IF AMSTRAD HAS BEEN ADVISED OF THE POSSIBILITY OF SUCH DAMAGES, OR FOR ANY CLAIM BY ANY OTHER PARTY.

GENERAL

You may not sublicense, assign or transfer the licence or the program except as expressly provided in this Agreement. Any attempt otherwise to sublicense, assign or transfer any of the rights, duties, or obligations hereunder is void.

This Agreement shall be governed by and construed in accordance with the laws of England.

Should you have any questions concerning this Agreement, you may contact AMSTRAD by writing to Amstrad plc, Brentwood House, 169 Kings Road, Brentwood, Essex, CM14 4EF.

YOU ACKNOWLEDGE THAT YOU HAVE READ THIS AGREEMENT, UNDERSTAND IT AND AGREE TO BE BOUND BY ITS TERMS AND CONDITIONS. YOU FURTHER AGREE THAT IT IS THE COMPLETE AND EXCLUSIVE STATEMENT OF THE AGREEMENT BETWEEN YOU AND AMSTRAD WHICH SUPERSEDES ANY PROPOSAL OR PRIOR AGREEMENT, ORAL OR WRITTEN, AND ANY COMMUNICATIONS BETWEEN US RELATING TO THE SUBJECT MATTER OF THIS AGREEMENT.

THIS AGREEMENT DOES NOT AFFECT YOUR STATUTORY RIGHTS.

THE UNIVERSITY OF CHICAGO
DIVISION OF THE PHYSICAL SCIENCES
DEPARTMENT OF CHEMISTRY
5708 SOUTH CAMPUS DRIVE
CHICAGO, ILLINOIS 60637

PHYSICAL CHEMISTRY

HARD DISK DRIVE IS C:

FLOPPY DRIVE IS A:

NOTE D.A. IS DEFECT
HT VCCORRET
NOT HD?

WORKS TAKE (S) C:/F FOR HD A: FOR DISK

DIR/W DIR ON FLOPPY

DIR (S) C:/H HARD/DISK

A:/W A DRIVE TO SWITCH

C:/W H. DRIVE FROM A TO HD & BACK
JUST A: OR C:

PATTERN W GIVES
ONE WINDOW
OF DATA
A TIME.

OBTAIN LINES VER 3.05 [L.OBJ]:

TO COPY COMMAND USE ← → OR F3

A: DRIVE FLOPPY CAN BE ADDRESSED AS B: OR A: C: IS STILL
H. DRIVE.

SEE CHUDSK FOR C DRIVE

DIR/P/W^AHOLE DISPLAY DIR
E

and conditions are produced to that third party and prior to the transfer that party agrees and undertakes to observe and continue to observe the same. Without such transfer and undertaking any application of The Program or copies thereof by any other person will not be authorised by Locomotive and will be in breach of Locomotive's copyright and other proprietary rights.

4 Documentation

The documentation accompanying The Program is also copyright Locomotive. However, no right to reproduce that documentation in part or in whole is granted by Locomotive. Should additional copies of the documentation be required for whatever reason, application must be made in writing to Locomotive which will be considered in its discretion.

5 Breach

If the user for the time being acts in breach of any of these terms and conditions it shall indemnify Locomotive against all loss suffered (including loss of profits) and the licence granted hereunder shall be deemed to be terminated forthwith. On termination the user shall deliver up to Locomotive all infringing and lawful copies of The Program.

6 Exclusions

Neither Locomotive nor any person authorised by it gives warranties or makes representations that the program is error free or will meet functions required by the user. It shall be the responsibility of the user to satisfy itself that The Program meets the user's requirements. The program is supplied on an 'as is' basis and save as expressly provided in these conditions all warranties of any nature (and whether express or implied) are excluded.

7 Liability

Amstrad warrants that the diskette on which the program is stored is free from material defect and through normal use will remain so for a period of 90 days after purchase. In the event of any breach of this warranty (or statutory warranty or conditions incapable of exclusion by these conditions) the responsibilities of Amstrad shall be limited to replacing the enclosed program or to returning the price paid for the same as they shall determine.

As the sole exception to the foregoing Locomotive will accept liability for death or personal injury resulting from its negligence. In no circumstance shall Locomotive be liable for any indirect or consequential costs damages or losses (including loss of business profits, operating time or otherwise) arising out of the use or inability to use the enclosed program and diskette and whether or not the likelihood of damage was advised to Locomotive or its dealer.

This notice does not affect your statutory rights.

A: /w
RETURNED
FROM
HD
TO
A DRIVE

AMSTRAD

AMSTRAD

PERSONAL COMPUTER

PC1640



User Instructions

PC1640