

# HOME COMPUTING WEEKLY

AN ARGUS SPECIALIST PUBLICATION

October 8-14 1985 No. 133 55p



Free  
Tape!

Coupon inside  
worth over £3

Special offers!

save up to  
£100 with  
our bumper  
bargains

Catch Monty  
on the Run!

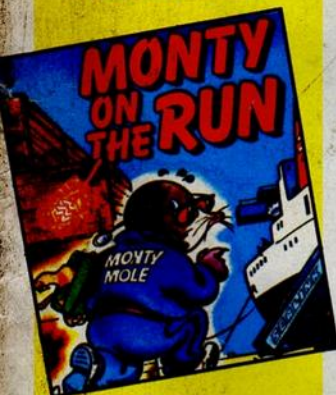

25 game  
pack prizes  
from



## Judge smashes pirates haven

British software houses are hoping to fire a broadside against Italian software pirates at a meeting held today (Tuesday 8th October).

Gruppo Editoriale Jackson, the largest publisher of computer magazines and software in Italy, have recently had a court judgement against the pirates which has received national publicity from the Italian media. They successfully prosecuted Sipe, a publisher of software compilations, and Mepe their distributor who had released a games compilation tape which included Mikro-Gen's Everyone's a Wally game.

In Italy, where the software market is very small by comparison with this country, pirates are anything but subtle in their approach. They openly release tapes containing up to 16 games none of which are officially licenced and sell these via news-stands at a price of about £4 (10-12,000 lire).

The only way in which they disguise the games is by changing the names which means that unless the game is licenced to an Italian company there is little chance of prosecution. The meeting of Jackson and the British software houses planned for today is meant to put a stop to this.

In the words of Mr Comboni, editorial director of Jackson, "We are looking for the rights to prosecute on behalf of the British software houses."

In the recent court case, the Judge - Mr Sorrentino - requested that two C64 machines and the two games be taken into the court so that he could be certain that the games were identical. He was convinced and ordered all the pirate compilations to be seized and removed from the newsstands.

It is generally agreed that this case has brought the Italian piracy

problem to a head and that there is a chance that through the courts the pirates can be destroyed. We haven't been able to obtain a full list of the games which have been included on these compilations yet but Raid Over Moscow is thought to be one of the other titles.

There are very few Italian software houses which write for the home computer market. "I can only think of one or two," claimed Mr Comboni. "That is why we are sure that 90% of the titles on these tapes come from England or America."

Mikro-Gen is not the only British company who stand to lose quite large sums due to this Continental piracy and that is why they are organising this meeting. Tony Bentley believes that Jackson "have a lot of clout in the Italian market" and that they have "got the pirates on the run."



One of Jackson's  
micro-mags

Perhaps this meeting could be the turning point and bring a real reward for the British software industry.

## Windfalls for all!

This copy of Home Computing Weekly represents the greatest value for money of any computer magazine on the market!

In this week's magazine we have a range of offers that will make this issue worth over 200 times the cover price. There are offers of all types and varieties.

If you are a user of the most popular home computers then you can claim a free tape by returning the coupon inside. Argus Press Software will send a copy of their famous magazine tapes to each HCW reader sending the coupon and a stamped addressed envelope to their home which means that this offer alone makes your magazine worth between three and four

pounds.

The centre spread of this issue contains six special offer coupons which can save our readers big money on those soft and hardware purchases. To take just one example, Mirrorsoft are offering a discount of nearly £10 on a special two pack of their games which will cost you only £3.99. Watch out for more big value offers in the coming weeks.

We are also able to offer free cassettes for all those taking a subscription to your favourite weekly magazine. Any reader who chooses a year's supply can claim three free tapes, including top selling Quick-silva titles absolutely free, saving up to £20 on shop prices.

Robin Hood  
in the Dungeon  
p. 37

Ron Complex  
in the Slammer  
p. 4

Commodore  
machine code  
p. 28

Nominate  
your dealer  
of the year  
p. 18

6 pages of  
software reviews  
p. 12

THE COUNTDOWN HAS BEGUN

# CRITICAL MASS

From DURELL

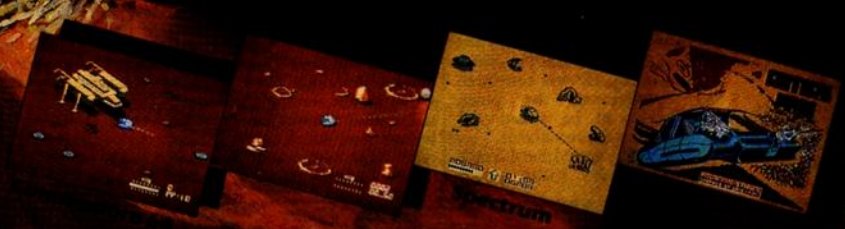
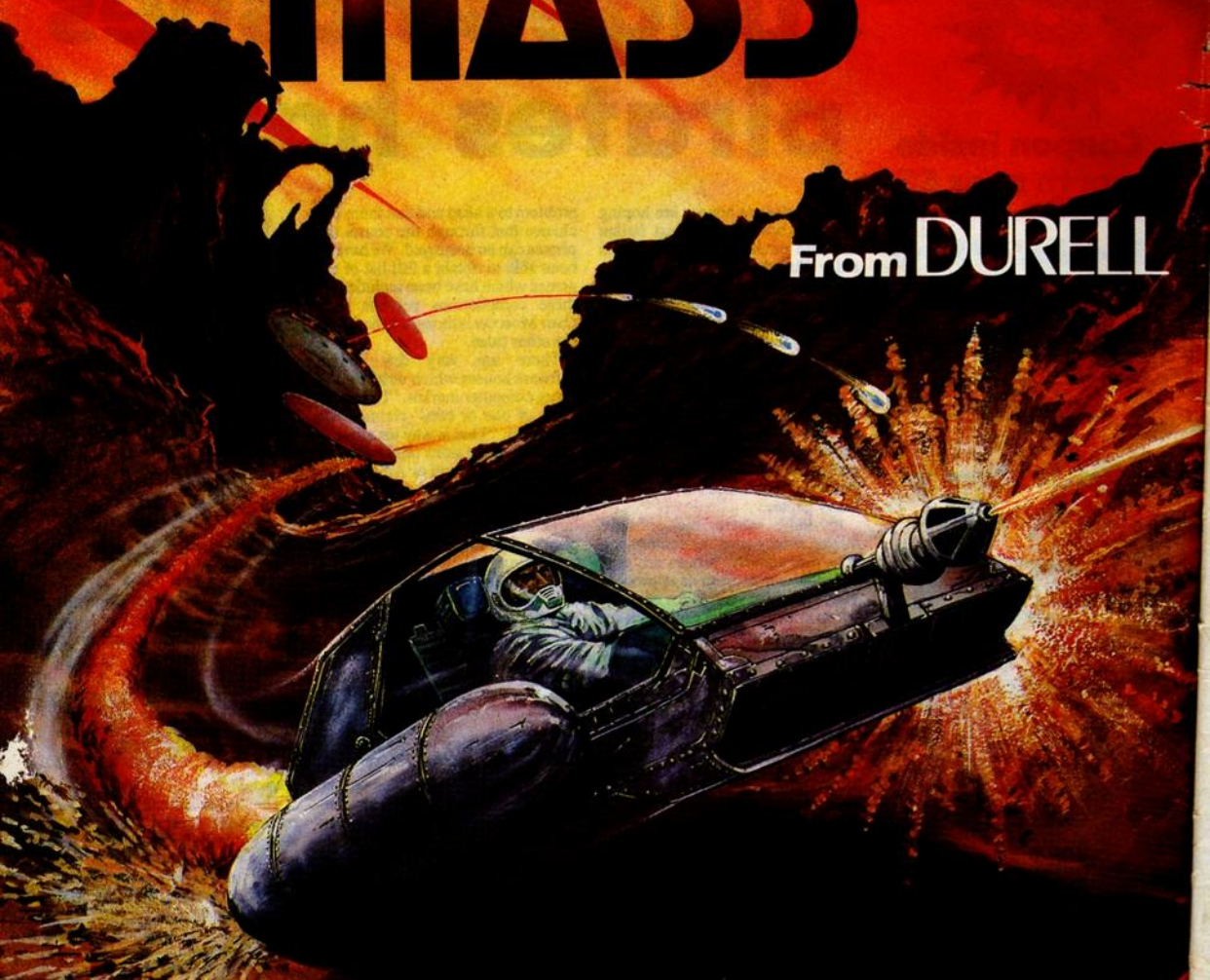

Write now for details of Durell's  
Great New Competition also  
T-shirts, Catalogue  
and Post

014AB

# HOME COMPUTING WEEKLY

Editor Dave Carlos  
 Assistant Editor Bryan Ralph  
 Editorial Assistant Kerry Fowler  
 Group Editor Wendy Palmer  
 Design Tony Keep  
 Production Assistant Lyn Collis  
 Ad Manager Dominic Farlizzi  
 Classified Advertising David Horne  
 Publishing Director Peter Welham

## CONTENTS

October 8-October 14, 1985 No. 133

### Soapbox

Do readers realise the hypocrisy of the computer manufacturers when they complain about piracy? Companies who brought machines after Sinclair picked up the ZX Spectrum do not deserve any sympathy — they should have learnt from Uncle Clive's mistakes.

Manufacturers could keep the ROM routine for loading in a separate ROM chip which cannot be disassembled by any software. Then with a protection code similar to Amstrad's no-one could break into software using machine code. The ROM routine could be made complicated enough to make it virtually impossible to guess or come across the right routine by accident. The rest of the ROM could be published with a full disassembly as practised for the Amstrad and ZX Spectrum. For example, take the CPC464, add sprites, simplify the sound command, add procedures, include a built-in assembler and the option of a second processor 6502, 6809 and of course, the software protection.

The software publishers would flock to such a machine since this would give them automatic software protection. The technology exists to do this — so why hasn't it happened?  
**G.M.**



### SPECIAL FEATURES

- Our free tape offer .....5
- Bargains galore in our special offer bonanza .....19

### BBC

- Firmware intersheet — utility .....32

### COMMODORE

- Part two in our Code it! series .....28

### SPECTRUM

- Diced-pairs — game .....23

### REGULARS

- Ron Complex — the year of living dangerously .....4
- News .....6
- Releases .....10
- Reviews .....12
- Catch Monty in our Gremlin's competition ..26
- Classified ads start .....34
- Venture mania .....37



- Readers page .....38

Argus Specialist Publications Ltd.  
 No. 1 Golden Square, London W1R 3AB. 01-437 0626

Home Computing Weekly is published on Tuesdays. Subscriptions and back issues: Infonet Ltd, 10-13 Times House, 179 Marlowes, Hemel Hempstead, Herts HP1 1BB. 0442 48432. Trade distribution: Argus Press Sales and Distribution Ltd, 12-14 Paul Street, London EC2A 4JS. 01-247 8233. Printed by Alabaster Passmore & Sons, Ltd, of London and Maidstone, Kent. Design and origination: Argus Design Ltd, Circus House, 26 Little Portland Street, London W1N 5AF.

### BASIC LIVING

JIM BARKER\* JON WEDGE

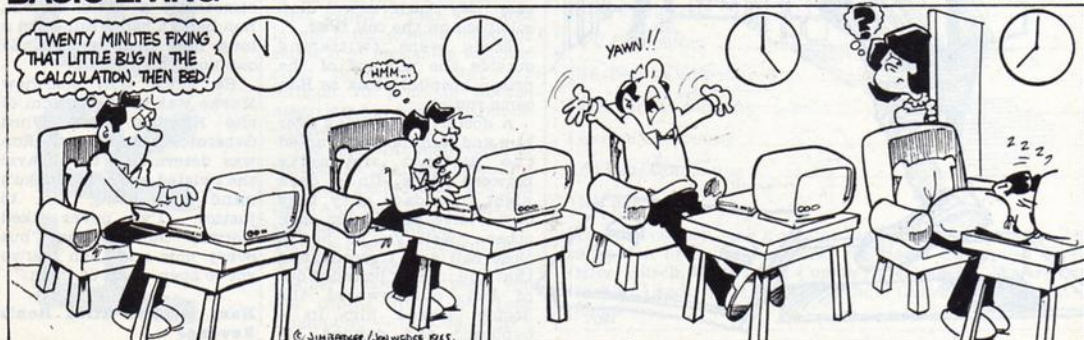

# RON COMPLEX RON COMPLEX RON COMPLEX



**Ron Complex plays charades for his life in the latest episode of the serial that's so dangerous it has to be written by a stunt man**

Ron Complex tore his copy of a Hundred and One Ways to Escape from Prison in half and threw it into the corner of the cell. He had one last cashew left in a tattered brown paper bag in his pocket and he popped the stale nut into his mouth, hoping that it would bring

him inspiration.

The cashew wedged itself in Ron's windpipe and the private investigator staggered to the door and dented the metal with his fist. The face of the guard appeared at the hatch as Ron, gasping for breath, pointed desperately down his throat to the guilty nut. "Come on Complex,

you've tried this old routine not five minutes ago — give me a break will ya?"

Ron continued waving his arms around wildly. "What is this — charades?" said the guard coldly. Ron nodded. "Alright, I've got all night, get on with it".

Ron held up four fingers. "Four words", said the guard. Ron signified it was the first word and head butted his hand twice. "Er, head, um, knockout, nutting someone?" "Ron nodded and put two fingers together. "Shorter? um, nut?" Ron nodded and picked up the waste bin, simultaneously pulling his ear. "Sounds like bin?, er in?"

Ron, now turning a fetching shade of blue made a T with his fingers. "The", said the guard. Ron pointed to his throat. "Neck? chin? no I don't get it. Ron pulled his ear weakly and made two horns above his head with his fingers. "Er antelope? moose? er, it wouldn't be goat would it?" Ron nodded frantically. "Sounds like goat... got it... throat... nut in the throat, well that was easy. My turn now." Ron collapsed on the cell floor.

Birds were twittering outside the window of the prison hospital block as Ron came round.

A doctor was leaning over him and Ron instantly noted the distinct similarity between them. On a dark night in a dark alley they could have passed for each other. "Well you've had a close call and I recommend that you..." Ron bounded out of bed, overpowered the doctor, locked him in a cupboard and donned his

white coat — it took five seconds and the coat was only five sizes too big.

Getting out of the prison was a cinch, although a nurse asked him why he had suddenly started wearing a trilby on his rounds.

Ron discarded the coat as he reached the gate — and bluffed his way past the guard by saying he'd just been for an interview for the governor's job. He turned to look back at the prison and gave the guard a cheery wave.

"I'm angry now and I'm getting angrier every moment" he thought. He turned to take the next step. "No, I'm not going to fall down this manhole. This is a new, meaner, more alert Ron Complex. A man on the run, a man with revenge on his mind. No more falling down lift shafts. No more taking the rap. No more Mr pleasant guy. Call me Mr Livid from now on."

The image of Murko was branded across his brain, Ron was contemplating mindless revenge but that was too simple. Murko — King Silicon — deserved something a little special. Ron hadn't had a hunch in a long, long time, but he had one now.

He knew that somehow Murko was at the bottom of the Random Code Word Generator scandal and Ron was determined to unravel the twisted warps of Murko's mind and bring him to justice. "I've never liked worms," thought Ron, "but every now and then you've got to open a can of them."

**Next week: Riled Ron's Revenge**

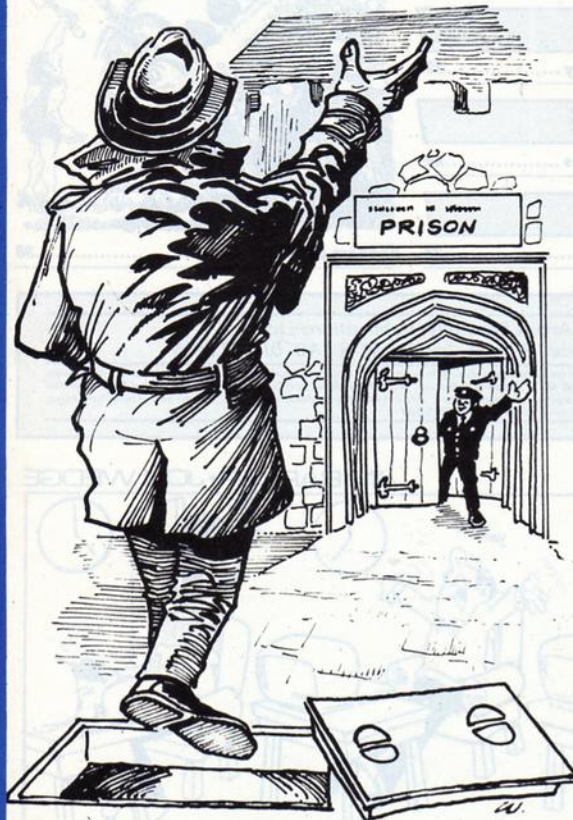

Here's an offer you can't refuse — free software for our readers!  
No coupons to collect — you only need to read on



# FREE TAPES

**T**here is a free cassette on offer for each and every HCW reader this week! All you need to get your free software cassette is the coupon below and a stamped addressed envelope big enough to hold a copy of your favourite weekly magazine.

We're sure you already know that Argus Press Software produce a range of monthly magazines on a tape. Each one contains at least four ready to run programs and a whole host of reviews, news and other interesting items.

The cassettes only need you to run the first program after which all the others are loaded automatically and there's hours of material for you to read and super games to play. One area in which the cassette magazine excels is in presenting machine code programs, they are difficult to print in normal magazines but a cinch to put on a cassette.

The tapes normally retail at between £3.25 and £3.99 but for a limited period only you can claim a cassette appropriate for your machine **FREE!** There are seven different titles of cassette magazine for a huge number of computer users, you can choose from: 64 Tape Computing — for C64 owners,

Electron Computing — for BBC and Electron owners, MSX Tape Computing — for those with a Japanese micro, C16/Plus 4 Computing — for owners of the smaller Commodore machines, CPC Computing — for owners of all Amstrad micros, finally there are two titles for Spectrum

owners — Spectrum Computing and 16/48 Computing. To claim your free cassette return the coupon and follow the instructions carefully — before you know what is happening your cassette will be returned through your letter box, well, allow the usual 28 days for delivery!

YES, I want to claim my free cassette magazine tape...

Please send to: (name) \_\_\_\_\_

at: (address) \_\_\_\_\_

\_\_\_\_\_ post code \_\_\_\_\_

Please send me:

Spectrum Computing \_\_\_\_\_

16/48 Computing \_\_\_\_\_

CPC Computing \_\_\_\_\_

C16/Plus 4 Computing \_\_\_\_\_

MSX Tape Computing \_\_\_\_\_

Electron Computing \_\_\_\_\_

C64 Tape Computing \_\_\_\_\_

**Tick one only**

Send this coupon with a stamped self-addressed envelope, large enough to hold this magazine, to: **Home Computing Weekly Offer, Hitech, Units 1 & 2, Conlon Developments, Watery Lane, Darwin, Lancs.** Your free tape should follow within 28 days of receipt.

## Communications round-up

It seems to have been a week for news and announcements about communications systems so here's a round-up of all the major items:

- The BBC have opened a viewdata service for the public. All you need is your micro and a modem with communications software and Owltel can be yours.

The service will give full details of all the BBC's software and books about their own computer, you guessed — The British Broadcasting Corporation Microcomputer system to give it its full title, as well as news and information about the computer literacy activities that they control. There will soon be the chance to download software and enter prize quizzes too.

Facilities are available for you to send Auntie your messages, orders and enquiries so you should find plenty to keep you amused. The number to ring is 01-927-5820 and it is open 24 hours a day (1200/75)

baud viewdata standard).

- Prestel have been making the news in two ways this week. They have launched the full telex link service and have started the full Education service which is described more fully elsewhere.

For some time now it has been possible to send telex messages to full subscribers to Telex but there was no way that they could reply. Now messages can be sent in both directions and at just 50 pence a time.

Incoming messages appear in the Prestel users' mailbox just like the other messages sent by electronic mail. All that you have to do to send your message is dial the Telex Link phone number and quote the mailbox number of the addressee. Perhaps you'd like to try it out by sending us a message at HCW, our mailbox number is 532860594. We are holding our breath in joyful expectation.

- Micronet haven't been silent this week either. They are very excited about their next Celebrity Chatline when William Powell MP, sponsor of the recent successful private

members bill on software piracy will be the guest.

There will be a chance for any Micronet member to ask questions of the politician and it will be an interesting exercise to see how many will be in favour of the protection which the bill offers to software producers.

Mr Powell will be available between 7 and 8.30 pm on Tuesday 29th October, so warm up your modem and work out your heckling slogans.

- Regular readers will have read the item a few weeks ago about the start of the Round Britain Race on Micronet. The game is played on screen for a range of cash prizes.

The first winner, chosen from the first 22 to get the correct answer, is Mr H J Collis of Danbury in Essex who wins £100. He claims to have "solved it in ten minutes. I just asked myself what I would do if I was setting the competition!" It rather looks as though Micronet are going to have to get tough in their next quiz which involves "various forms of confectionery". Sounds like a sweet little number to me...

Goodbye - see you soon on

OWLTEL

## Alligata hatches sequel with a difference

As Who Dares Wins gathers dust on the shelves due to a court injunction brought against Alligata Software by Elite to prevent the games distribution, Son of Who Dares Wins is rising from the ashes of the court battle over copyright.

Called Who Dares Wins II, Alligata's new game is unique in that it is a sequel without a game to follow up.

Alligata's Mike Mahoney told HCW, "There were 20 points of similarity talked about in the court case and all of these have now been changed."

The game now bears no resemblance to Capcom's

Commando stated Mike, "It is a completely different game in which the central character carries a machine gun and throws hand-grenades. But although scenes and objects have been changed it is still a one man against the enemy wargame."

"We've been working all hours God sends to get this one out," said Mike, "we've rewritten 40K of data but we were able to utilise some of the original routines. We intend it to be the fastest sequel on record."

Alligata are rush releasing Who Dares Wins 2 for the C64 (£7.95) with Amstrad and Spectrum versions to follow.

Alligata, 1 Orange St, Sheffield S1 4DW

## Acorn giveaway

It looks as though Dixon's have taken a leaf out of the squirrel's book with their new autumn offer.

A recent advert carried the flash "Free Acorn Electron plus software five-pack when you buy any Sanyo or Apricot personal computer". So all you have to do to get a free micro, once sold at £199, is persuade your dad, uncle, grannie, head-teacher or any other acquaintance or friend to spend between £799 and £1395 at Dixons and then walk off with the spoils.

Perhaps when their store of Acorns is completely exhausted Dixons will choose another, once popular, computer to give away with their business systems, free wild animals (Lynx or Dragon), free weapons (Sord), free starchart (Aquarius) or free chance to make good (Enterprise). Only time will tell.

### Micro-Live lives again

Micro-Live, the monthly follow up to the BBC's Computer Programme, is set to go weekly when it returns to your screens on Friday 11 October.

The program will have all the ingredients which have made it so popular in the past and with a new time of 7 pm it is likely to have a much wider viewing audience too.

The presenters will include Ian McNaught-Davis, Leslie Judd and Fred Harris at this side of the Atlantic and Prefs in the USA. One new item which is made possible by the change in time is the news section which will aim to give you a round-up of all the latest happenings on the micro scene.

Those who have their Fridays already committed will be able to watch the repeat, also on BBC 2 at 5.30 pm on Mondays. Could the repeat be titled Micro Live - Dead?



Leslie and Ian test pocket micros

### Exhibition mania

After the rather untimely demise of Rushworth Dales, owner of Computer Marketplace Exhibitions, the fate of a number of computer shows planned for this autumn has been in doubt.

Good news is on the way though — a management buy out has ensured the future of a number of exhibitions which will go ahead organised by Editionscheme.

The first exhibition for Amstrad Users has been taken up by Database publications and will go ahead at the announced time and place — Novotel on 5 & 6 October.

Other shows which will be held are:

Commodore Horizons Show, Tech West centre, 26 & 27 October

Acorn User Christmas Show, Central Hall Westminster, 22 & 23 November

6809 Show (Dragon and CoCo), Royal Horticultural Halls, 23 & 24 November

Acorn User Exhibition, venue not decided, July/August 1986

High Technology and Computers in Education Exhibition, Barbican Centre, 22-25 January 1986

**Editionscheme, 447 High Rd, Finchley, London N12 0AF**

### Small is beautiful

Epson are claiming to have developed the world's smallest 3.5" floppy disc drive and it almost looks as if you could carry one around in your top pocket.

The drive has been developed with the portable computer in mind and in one option is just 1 inch — 2.5 mm — high. This

means that it is now possible to have a double drive unit built into a portable machine and still hold it on your lap.

What Epson haven't told us yet is who is going to use the drive and when! As soon as we find out we'll let you know.

**Epson, Dorland Hse, 388 High Rd, Wembley HA9 6UH**



The drive to fit your pocket

### Little Red Book

For those who have trouble remembering who they are and where they are meant to be at any one moment, who might like to invest £2.75 in the Computer Users 1986 Diary from Letts.

The diary actually comes in three colours, blue, black and red and contains all that a micro-user might like to know about graphics, microprocessors, gargon and even about the leading computer magazines — guess which!

The diary section shows two weeks at a view and fits into your pocket without a bulge due to its slim format. It even has foil page edges so that it looks really flash.

**Charles Letts, Diary Hse, 77 Borough Rd, London SE1 1DW**



Your pocket pal

### New Juki

Micro Peripherals have recently announced that they are to market the new version of the Juki 6100 daisy wheel printer which sold in good number to home computing enthusiasts.

The new model is the Juki 6200 which has an improved speed and a much larger buffer than its predecessor. It runs at 32 characters per second, has a 3K buffer as standard, behaves like a diablo printer and can fit up to 197 characters on every line when used in proportional mode.

The standard centronics interface means that it can be used by most computers with a printer interface and at a price of £499 + VAT is likely to be quite popular. It does make you wonder how Amstrad can make a computer, disc drive and printer for £100 less though!

**Micro Peripherals, Intec 2 Unit 3, Hassocks Wd, Wade Road, Basingstoke, Hants RG24 0NE**

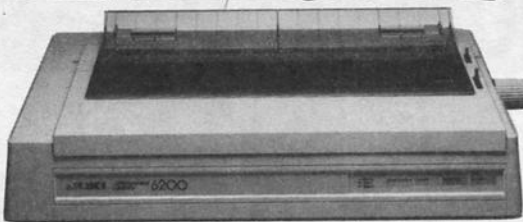

£500 pockets one of these

### Tell the world

Whilst we are on the subject of schools and viewdata services there is a new competition which allows schools to set up their own services as part of Micromedia 800 as their prize.

The MicroMedia awards are for those schools which have either Micro Viewdata or ComminTel software, both of which allow you to run a "closed circuit" viewdata service in schools using their BBC computers.

The aim of the competition is to make viewdata far better known and all schools have to do is compile a number of pages which could be used as part of a service. There is no restriction on content or style so there should be plenty of creative input possible.

Schools wishing to enter should contact Tecmedia at the address given here for more details.

**Tecmedia, 5 Granby St, Loughborough, Leics LE11 3DU**

### Prestel complete ed-services

Prestel have launched their full education service mainly aimed at schools.

The service was piloted recently but is now available to all subscribers and offers a whole range of services including Telesoftware for those involved in the educational endeavour.

The telesoftware service is central to the new education service and there will be a good range on offer to teachers and lecturers. What is more, it is hoped that they will be able to have demonstrations of the programs before they buy.

Downloading software from



### Easy on the pocket Prestel Education's cheap software

Prestel certainly scores over other methods in terms of speed. In just a few moments a program can be "squirted" down the telephone line onto a purchaser's own cassette or disc and the program can be used immediately.

There will be programs for the RML and BBC machines and the whole package is offered at a very special price to schools who aren't already subscribers. They pay a standing charge of £20 a quarter which gives them full access to Prestel and Micromedia and also offers a 33% discount on the normal Prestel connect time charges.

**Prestel Education, Telephone Hse, Temple Ave, London EC4Y 0HL**

### Wallowing in the M.U.D.

After wading through the acres of entries for our M.U.D. competition we have found a worthy, if rather stinky, winner.

The mortal who will be invited to London to take part in the first Great M.U.D. Spectacular is none other than Mirko the Putrid who is described by his friend B D Everingham in the following way: "Has not washed in 350 years, answer all his questions or he threatens to stand next to you." Congratulations Mirko, we will avoid you at the dungeon so let's hope you don't win or we might have to print a picture of the beast.

The runners-up each receive two Firebird games and the four selected for this accolade are Boogie, a friend of S B Jones, Super-Wimp who runs a mile at the merest hint of danger to his friend Jason Morgan, Mark Buckley suggested someone called Maggie, but we can't explain why and J M Aziz described a rather nasty Astogoth to win his prize.

Congratulations to all and keep watching these pages for details of the final on November 5th.

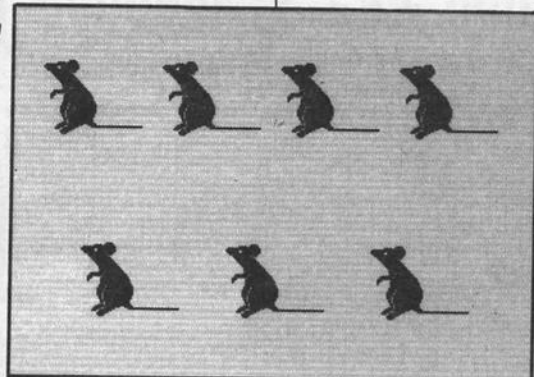

How many mice ?

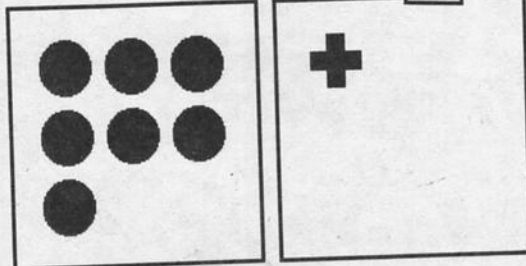

How many more circles than crosses ?

- 1 2 3 4 5 6 7 8 9



# DOCTOR WHO ON T.V. THIS AUTUMN

YES, but only if you have a Commodore 64, Spectrum, BBC Micro or Amstrad home computer. Thanks to a unique licensing agreement with the British Broadcasting Corporation and about four man-years of programming time, "Doctor Who and the Mines of Terror" will be seen on thousands of TV screens in the next few months.

Micro Power, whose Castle Quest program on the BBC Micro broke new ground with a special combination of adventure game and arcade-style graphics, are now offering a game five or six times more complex in size of playing area, graphics detail and the variety and number of challenging puzzles.

A spokesman for the BBC said that they were already aware that Micro Power were capable of producing top quality computer games. "We were really impressed by the sheer size and complexity of this game and could see that it presented the player with a true DOCTOR WHO scenario."

Micro Power's MD Bob Simpson said, "We are over the moon about this opportunity to combine a really first class game with a TV series of such standing. The fanatical following for DOCTOR WHO in over 50 countries should ensure excellent sales in all markets where the Commodore 64, Spectrum, Amstrad and BBC Micro are available."

The Commodore 64, Amstrad and BBC Micro versions are to be released in October, with the Spectrum game following one month later. Other versions are being considered. Contact Bob Simpson or Eileen Garfield on (0532) 458800.



## CAFE ROYAL LAUNCH

SIXTY representatives from the Press and Software Distributors attended the prestige Launch of Micro Power's DOCTOR WHO computer game at London's CAFE ROYAL in Regent Street. The first part of the proceedings was devoted to describing the game scenario, the way the game was developed and the comprehensive marketing strategy being implemented. Of particular note was the £25,000 Advertising Campaign!

One unusual revelation was the degree of support being offered to distributors and dealers. Most major distributors are being offered Personalised Trade Mailers FOC. Thus each distributor will be able without much effort to mail out to each of his dealers all the relevant details of the product. The dealer is invited to send for posters and also a free demonstration cassette/disk to leave running in the shop. Due to the widespread popularity of Doctor WHO, the game is expected to sell extremely well through the High Street Multiples.

Later on, those attending were treated to a pre-view of the highly detailed and attractive graphics, spanning the whole of the enormous playing area. Particularly impressive was the Scrollerama system of 4-way horizontal and vertical scrolling. The event was rounded off by a question and answer session and a superb buffet. A good time was had by all.



## ROD COUSENS TO EXPORT DOCTOR WHO

Micro Power have entered into an agreement with Rod Cousens — ex Managing Director of Quicksilver — to mastermind the export sales drive of their new DOCTOR WHO computer game.

Bob Simpson, Micro Power's MD, said, "Having got to know Rod at GOSH Meetings, and appreciated that no-one in the industry has more knowledge of overseas markets, I am delighted that he has agreed to act for us. With the Commodore 64 and Spectrum versions having the greatest potential, it was obvious that we did not have the time or experience to handle this aspect of the marketing ourselves."

Rod Cousens commenting on the deal said "I am pleased to be involved with Micro Power in promoting such a prestigious product. The 'Doctor Who' program should sell very well both at home and abroad. This highly complex arcade-style adventure is an excellent tribute to the popular TV character, whilst being a great challenge to the most ardent adventure fan." The extensive program documentation has been translated into German, French and Spanish. Overseas Buyers contact Rod on 0703 225282.

## PCW SHOW BREAKS ALL RECORDS

Although final statistics are not yet available, it is believed that more than 60 thousand visitors came to Olympia this year, with by far the greater proportion of interest in the so-called 'ailing' home computer side of the industry.

Micro Power's Software Manager Alan Butcher felt the show was a tremendous success, with enormous interest being shown in all four versions of Doctor Who and the Mines of Terror. Many visitors were attracted by the familiar Doctor Who theme which will feature as 'intro music' in the game.

"When can I buy it?" was the question most often asked. Micro Power's ardent BBC Micro supporters were at first a little disappointed that they would have to fork out as much as £18.95. However, when it was explained that the program came in a 16K ROM plus a cassette, giving nearly 28K of code and data, as opposed to the usual maximum of nearly 12K, they were well satisfied.

The cassette versions for the Commodore, Spectrum and Amstrad are only £14.95. When you consider that in addition to a first class program you are provided with extra items such as decoder cards, factory blueprints, detailed briefing booklets, symbols card, secret clue envelope etc., you realise the DOCTOR gives tremendous value for money. Disk versions are also planned.



No. 26 group shot Left to Right: Tony Sutcutt, Alan Butcher and Ian Clemmett

## NEW MOVES ON ANTI-PIRACY

Micro Power have taken the unusual step of keeping the completed version of their DOCTOR WHO program under wraps until the release date in October.

A spokesman said, "We have put together a slightly cut-down version of this highly complex adventure containing a substantial part of the map, puzzles etc. This will give reviewers and trade buyers a chance to assess it properly, without any risk to Micro Power that a copy could accidentally fall into the wrong hands. We are also very keen that few of the puzzles are solved before release date."

The fact that the program pack contains several printed items necessary to the player in the course of the game, has the added advantage of making piracy very expensive. Micro Power believe that the provision of a number of goodies with Acornsoft's ELITE program helped to reduce copying by the 'gifted amateur' brigade! The video-type case itself is of a unique design to further deter commercial piracy.

## RELEASES

**Rabbiting away**

Virgin Games have decided that it's the right time to pull the "Rabbit" label out of the hat. Virgin bought the label about 18 months ago, but as Nick Alexander explains, "The software market is really buoyant again after a year or more in the doldrums so we feel that this is the time to launch our Rabbit label."

Under the bye-line "Better than Budget", the four launch games (all priced at £3.99) take you from ghosts and labyrinths to gunpowder and bombs.

**Zyto** for the C64 will have all you multi-layered arcaders erupting with joy traversing volcanic terrains in boogie buggies and raunchy rockets — in the hope of finding the necessary components to build a bomb. You'll have to break codes and time records — but hopefully nothing more serious — in order to get your just desserts.

The ultimate of pyromaniac's fantasies, **The Great Fire of London**, on the Spectrum, has you in the grandiose role of Lord Mayor dowsing the flames with your team of fire-fighting experts. So it's back to the plague-ridden, rat-infested 1660's, (London doesn't change much) and it's up to your skills to re-write history.

Risen from the ashes is **High Rise Horror**, for the BBC (once again London doesn't change much) with you protecting a tower-block from a whole host of nasties.

Finally **Doriathe** again on the C64 has you bewitched, bothered and bewildered in the magical mazes of the underworld. Like a Milk-Tray man of the nether regions — you'll need stamina wisdom and even a few charmed amulets — and all because the secrets are hidden away.

Plans for regional labels of Rabbit — Scottish "Edinburgh", Welsh "Rarebit" and Irish "Stew" — have yet to be considered.

Virgin Rabbits?

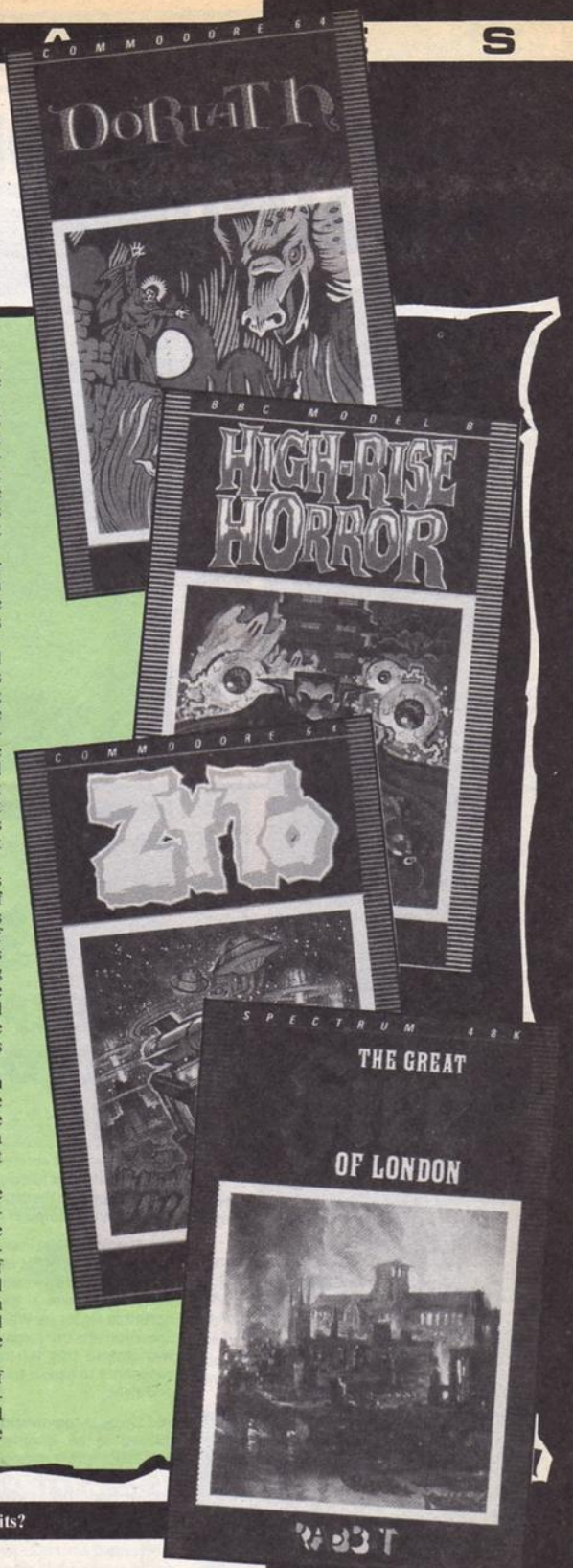

**Mastertronic go Mad**

Mastertronic has launched a new label called Mad Games, which will retail at £2.99. The first three releases, **The Last V8**, **Golden Talisman**, (both C64/128) and **Spellbound** (Spectrum) will be out during October.

Colin Johnson of Mastertronic explained that the reasoning behind Mad Games was quite sane, "It's going to take us into the full price market and it means we can market individual games with a view to charting. The £2.99 price tag means we will be able to pay programmers more and that of course will mean we can get better games. It also opens up the area of licensing deals and spin offs which isn't really possible on a budget price."

Colin supplied a few veiled

hints on the identity of a duo whose rights are in sights. Negotiations are still in progress but Colin could reveal that the pair "wear bowler hats, and they are always getting into another fine mess." The comedy team (no they are not Abbott and Costello) who shall remain nameless may be reaching the home micro in the new year.

On the Mastertronic label itself there is the imminent release of **Monty Python and the Holy Grail** on the C64.

Other Mastertronic titles due in October are **One Man and His Droid** (Spectrum) **Soul of A Robot** (Spectrum and Amstrad) and **Magic Quest and Space Hunter** (both C64). A current chart success **Action Biker** is being converted for the Atari and Amstrad.

**AB and lets C**

There is another new Liverpool software house and it is currently working on a block-busting arcade game.

I know that you've heard that before, but this time it just could be different — the programmer concerned is none other than Christian Urquhart who recently left Ocean to start Alpha Betum.

The game is called **Robot Messiah** and is quite a change for Urquhart who has the arcade hits Daley Thompson's Decathlon, Hunchback and Cavelon to his credit. It is certainly an arcade game and has over 150 different screens in order to cover the three different levels.

The first level has a passing resemblance to a Jet-man game in which you travel the underworld picking up envelopes. The second screen features a transportation game which allows access to the third level, the Test Centre.

The hero is a droid and at the end of the game he manages to re-program himself and then becomes the Robot Messiah of the title. It certainly looks exciting on paper and with graphics by Mike Smith, also of Ocean, the result should be spectacular.

The game will cost £7.95 and be available from the end of October.

**Bits and pieces**

- Ultimate whisk you back to the wonders of ancient Egypt in their unpronounceable, but promisingly superb, **Imhotep** for the C64 (£9.95). Set amongst the sand and pyramids, **Imhotep** has a variety of tasks to tackle deviously devised for him by those dastardly Egyptian gods (it's rumoured that the original program was in hieroglyphics, an ancient computer language).

- On a totally different plane, Cascades **Air Combat Emulator** — originally for the C16, now for the C64 — allows you to get the real feel of a high performance military jet — so realistic, in fact, that your ears pop if you reach the right altitude. The cockpit view is scenic as well as militaristic with hills and trees providing a home for SAM sites and tanks. **ACE** with its high speed 3D solid graphics and 300 sprite images is priced at £9.95 and Amstrad and Spectrum versions are expected soon.

- Jumping on the Rambo band-wagon (will there be room for any more?) Elite have secured the rights for **Commando** which you'll be interested to know is called Space Invasion in West Germany. **Commando**, a coin-operated arcade chart-topper, stars, would you believe, a crack soldier who has undergone secret training in the depth of the jungle — in order to fight off an alien force. Not the news story of the year, but it has been doing very well in homes all across Europe. Due for release in November, **Commando** will be available for the Four

"major" machines on cassette and on disc for the Commodore, Amstrad and BBC.

- A rather more frightening interpretation of human conflict is **Theatre Europe** from PSS converted to the Atari at £9.95.

Armageddon seems to be the only possible outcome as the tensions between NATO and the Warsaw Pact grow, with nuclear and chemical weapons being banded gaily about. Following a political persuasion of your choice, you can indirectly blow the world to smithereens. Enough said.

- For some light relief, a cold war of a rather different nature is the theme of Quicksilver's **Rupert and the Ice Palace**. It's up to the intrepid bear to anti-freeze his pals who've been frozen solid by old king cold, Jack Frost; steering Rupert clear of icicles and keeping him topped up with ice-pills is your problem. **Rupert and the Ice Palace** is for the C64 and is priced at £7.99.

- Finally it's time to announce the progeny of the Llamasoft/Arioasoft union whereby selected Llama releases will be marketed by Ariola. **Batalyx** is the first joint release, devised by Jeff Minter and available for the C64 primarily on disc (£12.95) and later in October, on cassette (£9.95).

**Batalyx** actually comprises six sub-games requiring a range of game playing skills from strategy to pure arcade, including somewhat suspect Hallucin-O-Bomblets and Mutant camels this sounds like a fantasy trip supreme.

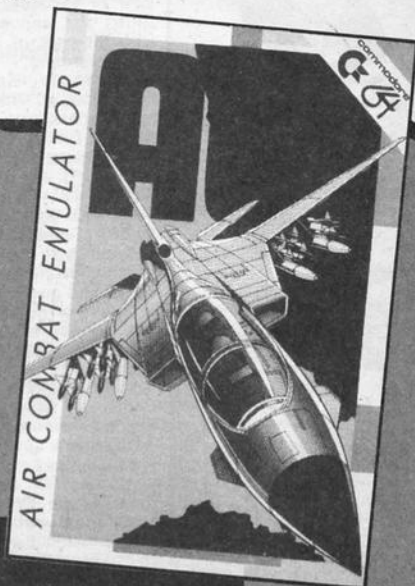

## SOFTWARE



### Frank Bruno's Boxing

Hooray for an attempt to produce a boxing game which breaks away from the mould. Other simulations use a side on view of the ring but this one shows the opponent face on with the back of Mr Bruno in the foreground.

There are eight cartoon opponents, all with silly names, and their attributes are stored in separate files on the reverse side of the cassette.

Control of the boxer is difficult and you have to batten down your joysticks before the game commences. This is because there are two ways in which control can be exercised either with one joystick and the keyboard or with two joysticks. Either way, it is difficult to move unless the controllers are tied down firmly.

The first opponent is the Canadian Crusher, a mean looking hombre who, if the theme tune is anything to go by, is a lumberjack with effeminate tendencies but none of these show as the Crusher tries to grind down your opposition.

The screen display for each fight shows Bruno in the top left corner and his opponent on the opposite side of the scoreboard. Under this is the ring with a fair sized audience realistically cheering the boxers on. An indication of your boxer's success is given by a line which extends for each blow landed towards a KO symbol. When this line reaches the symbol a few well landed blows will knock the punch-drunk pugilist in front of you.

After three such knock-downs in the round whether they be for or against you, the boxer will not rise again.

Victory will display an Elite Video Boxing Association

**Price:** £7.95

**Publisher:** Elite Systems

**Address:** Anchor Hse, Anchor Rd, Aldridge, Walsall, W Midlands

Membership Code which is based on the initials which you have entered. This code is the key to allowing you to load the next boxer into the ring. It's a pity that more thought did not go into the design of the alphanumeric characters which make up this code. I found it difficult to decide whether the next character was a letter 'O' or a zero, and 'I' or a figure one, etc.

The range of punches at your disposal is sufficient to keep you tied up in knots throughout each bout. In addition to punching right and left you can duck, dodge right and left, and raise or lower your guard. Changing of the guard determines whether the next punch will be a body blow or one to the head and a controlled variation between the two can open up the gaps necessary to land a scoring punch.

When the KO meter reaches maximum the punching capabilities are increased with the addition of an uppercut which can be the secret to success but if the opponent lands a blow the meter will drop rapidly and the softening up process can start again.

A master table is kept of the record times in which the various contenders have been defeated during the current session but it doesn't appear to be possible to save these results to tape to keep a running record of the victories achieved over the course of several sessions.

Whatever your views on the subject of boxing in the real world, this game holds a lot of excitement and underlines the skill in timing required for eventual success. Maybe there's already too much violence on television but perhaps there's a little room left for a game of this quality.

**E.D.**



### Merlock the Mede

Merlock the Mede contains two adventures, forming the first two parts of an eight part challenge which, when completed, will enable you to claim a free Terminal Merlock Digital Watch.

The first adventure is The Deeds of Glegarry Hall in which you must find deeds and bonds concealed in Glegarry Hall, forming the bulk of the estate of a rich eccentric who had retired as a recluse with some loyal and long-suffering servants. The setting, despite the introduction, is modern.

Some of the rooms are illustrated in graphics, which fill about a third of the screen, and all the locations have a reasonable description, helping to build up the atmosphere. However, the game is very fussy about how you can refer to objects and to make matters worse there is no vocabulary list given, so that selecting the appropriate verbs is difficult.

The other game, The Ashes of Alucard, is best forgotten. Although predominantly text — there are minuscule graphics of some of the objects — no attempt at conveying an interesting description of the locations has been made, for example, "You are in a graveyard most of the graves are overgrown with weeds and things like that."

The most glaring mistakes in the text are the confusion between "here" and "hear" and the use of "piece" instead of "peace". The game is straightforward, provided you don't get randomly killed by wandering zombies.

Even though The Deeds of Glegarry Hall is easily the better game, it is let down by the poor command interpreter — at least the price is reasonable.

**S.J.E.**

**Price:** £5.95

**Publisher:** Terminal Software  
**Address:** 353 Bury Old Road, Prestwich, Manchester M25 5AW

C64



SPECTRUM



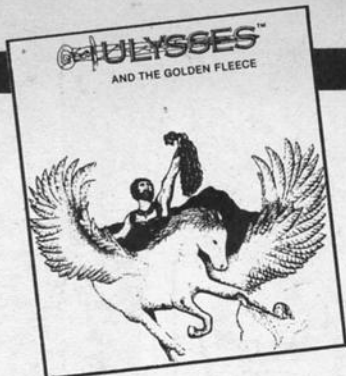

### Ulysses and the Golden Fleece

Despite the apparent confusion within the title this is an excellent adventure which has stood the test of time successfully.

If my Greek mythology is correct it was Jason who undertook the original quest for the Golden Fleece, but I'm sure the programmer's were aware of this and have merely added Ulysses' name for the sake of a richer series of problems on which to draw.

About five years ago, this was the first adventure which I ever played, so forgive me if this review has something of a rosy glow of nostalgia about it. In those days it was available for the Apple computer and its graphic screens even predate The Hobbit, plus the fact that even the original had a certain amount of activity included. For instance, at one point you see a bottle floating about in the sea. The command "take bottle" results in the expected response "taken", but the bottle also disappears from the graphic screen.

The aim is to find the Golden Fleece and to accomplish this you must first of all wander about the town finding money and buying weapons and provisions to see you through. A visit to the king's palace is always a good idea, but before you can enter you must give the guard the password. In the original game this, for some inexplicable reason, was "yes" but I'm pleased to note that this has been changed and my lips are sealed.

Another guard is positioned on the seafront guarding a ship which is also required for the adventure but first a crew must be hired. The only likely source of a crew is the local tavern where a motley assortment of drunken sots can be found. Still beggars can't be choosers and

with a bit of luck and bribery they will follow you anywhere and may not even mutiny.

The game is only available on disc and like the Zork Trilogy from Infocom the vast majority of the game is called into the computer when needed. Even some of the responses are left on the disc which gives this game a slower response time but access to many more phrases than would otherwise be possible.

The only way in which this game shows its age is the range of vocabulary used. In a game of this sophistication we have come to expect a reasonably intelligent system which can decipher fairly complex sentence structures. Since this is the preserve of the elite and also because I judge adventures by the complexity of the situations encountered I won't harp on too much about this.

During the game you will meet many other characters who will help or hinder — remember, strange things happen at sea. If your ship drifts around too much as you try to negotiate the maze, a wretched seagull appears to steal all that you possess and you may as well quit and start again.

In common with most adventures this has the facility to save your position at any point so that you can come back another day to complete your journey or merely safeguard against being wiped out at the next turn in the road.

The conversion to the 64 appears to have been extremely faithful to the original, even the graphics are recognisable though colour has been added since I first played it all those moons ago.

Meeting this conversion has reunited me with an old friend and I recommend that you give him a chance too.

E.D.



### Subterranean Stryker

This game is rather reminiscent of the defender type of game but it also borrows from other popular arcade games.

You are piloting a spacecraft and must collect the various trapped prisoners who appear to be working in the mines. This involves you flying around the caverns, destroying or avoiding any malevolent aliens that get in your way.

The game's landscapes remind me of the epic Sorcery, particularly the countryside ones. You have narrow gaps to get through. Moving barriers to pass correctly to get into a previously untouchable section of caverns and many varied aliens to deal with.

The game is rather derivative and doesn't employ any stunning new features. The graphics are not up to the standard of Sorcery and the sound is average. Yet this game holds a thrill, something undefinable that makes you want to have another attempt.

This is a decent program from Amsoft. I would, however, like to have seen it at a lower price. I think much of their software for the Amstrad should have prices reduced to a level more compatible with Spectrum software prices.

Grumbles over, I think it's an enjoyable arcade game. C.G.

Price: £8.95

Publisher: Amsoft

Address: 169 Kings Rd, Brentwood, Essex CM14 4EF



Flipped



Hooked



Keen



Yawning



Comatose

Price: £14.95 (disc only)

Publisher: US Gold

Address: Unit 10, The Parkway Ind Ctre, Heneage St, Birmingham B7 4LY

C64



AMSTRAD





### Highway Encounter

The aliens have landed! Original what? Having conquered the rest of the world they have set out along the last great highway to world domination. Why they are travelling by road I don't exactly know, but it's the basis of a great game.

You are what is known as a "main vortron", a type of dalek. You must take your merry band of droids (auto vortons) down this road, defeat the oncoming aliens, and destroy the enemy stronghold. This fortress can only be destroyed by using that ultra powerful weapon, the vorton. The vorton may be incredibly powerful but it hasn't got much of a range. It is for this reason that you and your metal buddies must push the vorton all the way to the enemy camp.

The road is littered with oil drums, pillars, and hovering mines, all of which make pushing a vorton a pretty tricky business. Especially when the droids you are working with are a little lacking in the old logic banks. They line up behind the vorton and push, they only push in a straight line, and they only stop when they hit an immovable object or you stand in front of them. Should you have to rush off and destroy a few aliens they carry on without you, and get shot to bits! Defending your auto vortons is of the utmost importance as they are your replacements should you be terminated.

The graphics are three dimensional, complex, and very Sinclair Spectrum. Fortunately on this occasion the last factor did not detract from the game's playability, it's a stunner! **J.R.**

Price: £8.95

Publisher: Vortex Software

Address: Vortex Hse, 24 Kansas Ave, South Langworthy Rd, Salford M5 2GL

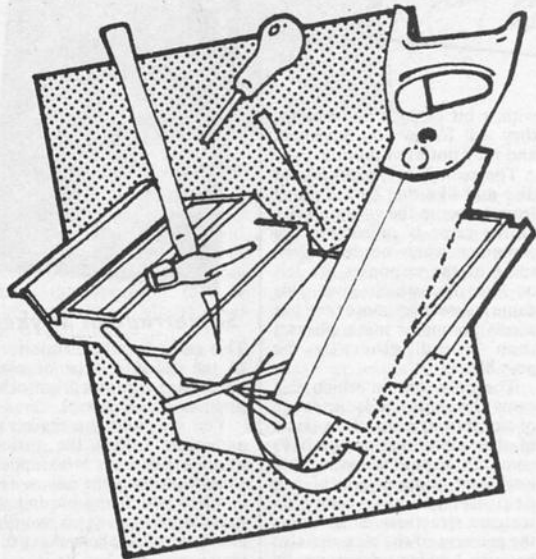

### Scratchpad

A common criticism of people not used to the delights of computing is that computers are nothing more than expensive toys which, if you are really pushed to justify, might just be used to sort out home finances and the like. Of course, they always add with an air of having won the argument, you could do it with a pencil and the back of an old envelope. But of course.

What then would they make of Scratchpad, an ideas organiser for the Beeb? A facility fairly common on machines like the Apple or the Mac, this is really just pencil and paper writ large — a self-cataloguing aid to the flow of ideas that usually get lost precisely because they are on scraps of paper. Supplied on disc, you use the program to enter up to 40 ideas (200 with the 6502 Second Processor) in one of 20 cells or in a general catch-all cell area. Once ideas have flowed (and the utility in use positively encourages you to keep thinking and not worry

about how to store ideas) you can then enter each cell in turn and start sorting the ideas.

This you can do in various useful ways: ideas can be altered, entered, deleted, swapped between cells, edited, changed in order or indented to show the structure of a run of ideas. At your leisure, you can arrange an order to your earlier random ideas — as well as returning at a later date to idea cells stored on disc. Finally, the structured ideas can be printed in your chosen format or inserted as a file into the word processor View.

I found Scratchpad very useful and can see myself returning to it again and again — of course, I do a fair amount of writing. There are some minor quibbles about it, however; the main ones from my point of view being the lack of an option to create a Word-wise file and the price which, I'm afraid, will limit its market. Something this useful and easy to use really ought to do well — despite the doubters with their pencils and papers. **D.R.**

Price: £24.95

Publisher: Innovative Software

Address:



### Halley's Comet

Cancel those expensive visits to London's Planetarium — this program effectively replaces them. Don't be misled by the title, as any reference to Halley's Comet is a minute portion of this superb educational production. When Halley's Comet has gone this program and its comprehensive manual, will still be providing stalwart service in any science department.

Written with the Hisoft Pascal Compiler it contains an unbelievable amount of information that is used to produce Starmaps and Planetary orbits for any date before today or in the future.

The first program, The Solar System, shows planetary orbits on a large or small scale and from any angle, then drops the observer onto the plane containing the Earth's orbit. Pressing key 'N' removes the axial tilt and 'D' shows what happens from March 21st to September 23rd. Any date desired can be selected and the orbit of Halley's Comet can also be studied with planets represented by letters. It is suggested that March in 6 B.C. is found when Earth, Jupiter and Saturn are in a straight line — called a triple conjunction — that is a possible explanation for the Star of Bethlehem.

The vast Planetarium program shows the sky and view below the horizon for any dates in any direction chosen. Although only 246 of the brightest stars have been used, they're still difficult to see on a light screen — so Anima have provided a darkening key.

I could go on extolling the virtues — but suffice it to say — it's an astronomical experience. **T.W.**

Price: £8.95

Publisher: Anima Scientific Computing

Address: 23 Crawley Avenue, Hebburn, Tyne & Wear





### The Epic

A bold attempt by Turtle Software to give value for money by putting six games onto one cassette. Reviewed in that light, the collection succeeds. But some of the individual programs are not up to present standards.

Game one, Aliquid Simplex, needs Professor Hilfe to collect pieces of his robot, Frankie, to reconnect them on a bed before an explosion, avoiding various pieces of equipment ast to screen 3, where I was stopped. It has large animated sprite graphics, smooth movement, two channel simulated music, high score table, bonus points and extra lives.

Sprayman has three types of sprays intended to eliminate three different creatures plus a fourth to destroy T.N.T. This fast game has the spray colours and a bonus box at screen bottom and a hand spray that you move around the screen.

3-D Blood Dungeon has a gory loading screen, surprise finish, four difficulty levels, high score tables and time limit. You visit 48 rooms, killing the snake-like guardians in the rooms that match your vital force level, to rescue Pixel Ramtop from her ghastly fate.

Next is Snakes Alive, where the fast snake must find nine eggs in 48 locations; and One Man and His Job, a dodge and collect game, follows using nine screens to finally squash a hideous face.

The final game, The Moons of Tantalus, has three stages in getting a space freighter into orbit to shoot an enemy base.

You can't load a game separately, but have to load all first.

T.W.

Price: £8.95

Publisher: Turtle Software

Address: Bridge St Mills, Witney, Oxon OX8 6YH

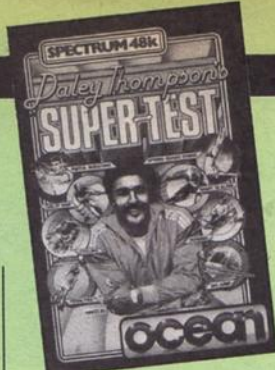

### Daley Thompson's Super Test

For his Super Test, Daley Thompson has diversified into eight new events, divided into two days of competition — only one day can be loaded at a time.

In rowing, cycling and tug-o-war nothing more than strenuous joystick action — or keyboard bashing — is needed. The penalty shooting and ski-jump require both joystick waggling and careful timing, if you're to avoid suffering a limb-breaking fall on the ski-jump, or you could waste your penalty by ballooning the shot over the bar. Fortunately, the keys can be re-defined, so that you can even out the keyboard wear.

In pistol shooting one of six targets will appear for a short time and you have a sight to guide towards it, but you can't retrace your steps. A close up of the target shows the position of your shots — very useful since the sight is slightly mis-aligned.

Take off, number of somersaults, dive finish and overall grace are marked by four judges in the spring board diving. The dive's height depends on the timing of the jump while continuous left/right movement makes you somersault.

For the ski slalom you must strike a delicate balance between going fast enough to qualify and going slow enough to manoeuvre between the poles. You have three lives, a life is lost every time you fail to qualify — the qualifying targets get harder each time round.

Smooth action and good graphics make this game great fun — if you and your computer can stand the strain!

S.J.E.

Price: £6.90

Publisher: Ocean Software

Address: Ocean House, 6 Central St, Manchester M2



### Brian Jack's Superstar Challenge

Frankly, I've had my fill of decathlon-styled games. They usually place too much emphasis on thrashing the joystick back and forth and little to do with dexterity, hand and eye co-ordination or any other skill.

I held higher hopes for this game. Having watched and enjoyed the perennial Superstars series on television, I hoped that the game's more interesting selection of events would be dealt with well by the programmers and produce an excellent offering. Sadly, I don't think that this has been the case though more likely than not it will still be a big smash hit.

The events on offer are 100 metres dash, cycling, swimming, canoeing — these four all involve little more than moving the joystick back and forth as quickly as possible. The other four events, squat thrusts, the parallel bars, archery and football are a little more sophisticated.

The two gym tests are well simulated in this game and not easy to become proficient at. Archery is the best of the eight events in that there is a fair amount of skill involved to score well. Football, in complete contrast, seems to be more of a lottery than anything. Controlling your footballer as he dribbles around cones, you must then line him up for his shot at goal. You seem to have very little control of this latter stage.

Overall, "keen" seems a fair rating for the game. The graphics are good and the whole package runs smoothly and at a reasonable price but I found it lacking in addictiveness.

Price: £7.95

Publisher: Martech

Address: Martech House, Bay Terr, Perensy Bay, E Sussex BN24 6EE



### Amstest

Now here's a program package that you don't see every day. A cassette offering a complete diagnostic test for your computer, in this case, your Amstrad. The package essentially consists of three programs, each checking out a part of the Amstrad hardware.

The first program according to Amstrad, "interrogates the major silicon chips of the computer. If a fault condition is found then it will be announced." On running the program, various pretty designs appear on the screen which Amsoft say are merely a by-product of the interrogation of the CPU; my own view is that they have been added by Amsoft to make it look as though something is happening.

The programs on the other side tests keyboard and cassette and the video monitor. The video tests simply align colours, lines and blocks in a way such that you can check your screen for clarity and colour definition. Frankly, I feel that this could have been done, just as well, with a short BASIC program written by the user.

I cannot say much else about this piece of software — no faults were found (or should I say reported) and the colour, sound, keyboard and cassette tests all seem satisfactory. Great, but what else can you do with it. The answer: nothing!

While this piece of software might be worthwhile for a company repairing Amstrads or a retailer checking his stock before sale, I cannot see much market elsewhere. I have a much better test for your Amstrad. Switch it on, play a few games, write a few lines of a BASIC program and save it and recall it from tape. If all that works, then more likely than not you have a serviceable Amstrad.

Price: £8.95  
Publisher: Amsoft  
Address: 169 Kings Rd, Brentwood, Essex CM14 4EF





### Southern Belle

This is a full simulation of driving a steam engine on the line from Victoria to Brighton. The screen divides into a number of sections, the principal one taken up by a view into the open cab to allow you to see various gauges, whilst towards you, features of the landscape like bridges and stations scroll in wire frame 3-D giving the impression of movement. Other sections deal with messages, signals, gradients etc, whilst the timetable you're supposed to run to can be called up with another key press. Graphically it seems just like the Spectrum version, and I would have liked the Amstrad's superior graphics to have been used, though there are some convincing chuffing noises from the sound chip.

Driving a train is hard, so there are first class instructions, and the option to take only partial control with the computer doing the rest while you learn. The engine responds clearly to your handling, and all sorts of things can go wrong! At the end of a training run, you get a detailed assessment of your performance, including what you did badly. To be fully in control, you must use eight different controls, stick to the timetable, and observe the safety rules. I suspect that excellence will only come after weeks of practice.

Pleasing to report, therefore, that the whole thing is very gripping — from the demo, through training, to a record run itself — and all sense of time is completely lost. Most enjoyable, and good value.

D.M.

Price: £7.95

Publisher: Hewson Consultants

Address: 56B Milton Trading Est, Milton, Abingdon, Oxon OX14 4RX



### The Professional Touch: Screenplay

A tape and book package which seeks to show you the production techniques involved in making a film/TV programme then providing you with simple software to write, design the scenery, compose the music, and animate the characters in an on-screen cartoon which can be transferred to your video recorder.

The detailed, well-illustrated book gives some historical background, the workings of a film camera and film tricks, how TV works and the various activities which go into a programme like production, wardrobe, soundtrack, animation and so on. Very informative.

The software is a compact suite of icon-driven programs which allows you to write your screen captions, draw backgrounds, design sprites, compose and save music, edit all the results together, save to tape, and finally, display your creation. You can employ animated characters, scrolling text, accompanying music, and edit away until you are satisfied with the result. Instructions are also given for saving this onto video tape, but they presume too much in terms of technical knowledge and equipment (you must have a modulator, for example). The result of this is to limit you to what can be held in memory at any one time, which is not much.

Even so, it's an intriguing package which gives genuine insight and which has much of value in the software, even though it is of limited sophistication in terms of the finished product, something akin to the illustrations which accompany some adventures.

D.M.

Price: £8.95

Publisher: Macmillan

Address: 4 Little Essex St, London WC2R 3LF

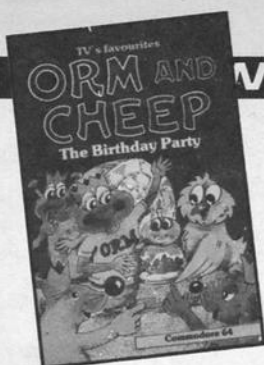

### Orm and Cheep: The Birthday Party

Lunchtime TV favourites Orm and Cheep appear in this companion to Narrow Squeaks which was reviewed in a previous issue of HCW.

It is Orm the worm's birthday and his friends Cheep, Mole, Snail, Hedgehog and Mouse have all been invited to his party. Cheep has the job of rounding everybody up because they are lost. Mole is in his labyrinth of tunnels and the other three are somewhere around the maze of roads which surround Orm's house. Also lurking about are the villains of the piece: Crow, Cat and Rat.

Using only the fire button of a joystick or by pressing any key on the keyboard, Cheep's direction can be controlled until all of the party goers have been found.

Before setting out on his search, Cheep must help Orm to find the ingredients for his birthday cake. All of these items are hidden in jars and after being told what is in each jar, Cheep must find them in the order which Orm indicates. Failure sends the pots crashing to the floor and the game repeats until Cheep is successful.

The mazes are not too difficult and detailed mapping is not really necessary but, as the instructions suggest, it is a good idea to encourage the child to map out the scene.

Above ground the road junctions each have a signpost and the colour of each arm of the sign changes in turn and pressing the key moves Cheep in the direction indicated. Underground Cheep moves to each exit in turn and after finding Mole the route must be retraced until the door to the outside world is located.

The nastier creatures are found lurking at various points around these mazes and underground they block some of the tunnels but above ground they

Price: £6.95

Publisher: Macmillan

Address: Hounds Mills, Basingstoke, Hants RG21 2XS

can be eliminated if Cheep has the correct members of the party with him.

The hardest part of the game comes when the party begins. All of the friends must find their correct place at the table under Orm's guidance. As you change their positions, Orm turns his head and a beep is heard for each party member who is in the correct place. Confusion can be caused because Orm also counts himself as a member of the party and his empty place is also indicated by a beep. If, for example, three places have been found which include Orm's position, and one of the other two correctly placed party goers is moved to Orm's place, the beep tally drops from three to one. I feel that this could utterly confound a very young child's attempt to complete this section of the game.

This is further compounded by Crow's arrival when Orm has disappeared to fetch his birthday cake because the friends panic and move around the table. On Orm's return, the player must then rearrange the party goers but the acceptable order has changed and the trial and error process must once again be undertaken.

If the programmers had decided to give an option whereby the correctly placed visitors flashed or something, I think the game would have wider appeal to a younger audience.

The graphics are of quite a high standard generally and the sound is not unpleasant. Really my only qualms relate to the difficulty level of the game which I feel would seriously challenge many adults let alone children. Since I have seen how children seem to have an inborn affinity towards computer games I may well be proved wrong but I'm sure that this package will keep many a little horror totally engrossed for long peaceful periods.

E.D.

AMSTRAD



AMSTRAD



C64





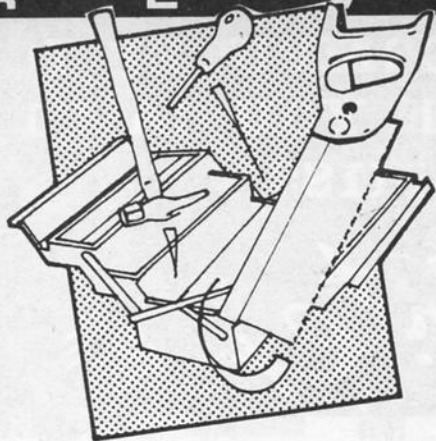

**Wordease**

In the battle between the two main BBC word processing systems, View and Wordwise Plus, users of the former (Acornsoft) product have so far been better served with extra utilities and linked suites. Now, in the last couple of months, the Wordwise Plus user-base is striking back; and where better than with this utility disc from Beebugsoft which adds the 20 or so most useful additional commands?

Assuming you have Wordwise Plus fitted as a ROM, booting Wordease gives you a fully interactive set of utilities placed in segment 9 of the word processor, with segment 8 reserved for additional options loaded from disc. Once loaded, you can move easily between Wordwise Plus, Wordease and BASIC and text in memory is kept safe. It uses a number of internal variables (listed so you can avoid these if you have other programs to run concurrently) but there is no full error trapping, due to the lack of error handling facilities in Wordwise Plus.

So what are you adding for your money? A fair number of the utilities merely make the use of Wordwise Plus rather easier; such as an auto-save facility for text files, a status report with a contents summary of each segment, an automatic unrestricted transfer of text from area to area (previously, as with much here, possible only manually), a function key editor and a selection of general utilities to use on the current text area (such as automatically aligning column of numbers in text).

Rather more complex are the disc menu options which

provides detailed information on text files held on disc (filename, directory letter, file length and the first 25 characters of the file) and a simple text editor to replace the rather inflexible Wordwise Plus search and replace options. These, like the rest of the package, are simple to use.

Finally, there is a set of utilities designed to make printing your processed text a little easier. You can, for example, simply and automatically insert any required printer codes — this defaults to the Epson range but can be readily changed to suit your own configuration. Further, you can now choose pre-defined characters from a menu and automatically add these to your text; replacing the lengthy process within Wordwise Plus which allows you to calculate and include sequences of embedded codes. However, this is only simple to use on unjustified text as Wordwise Plus remains unaware of details of these symbols and so your formatting and justification will be upset. A standard page handler and a label printer utility will be upset. A standard page handler and a label printer utility are also included.

As mentioned, this disc is easy to use and adds some genuinely useful extra commands to Wordwise Plus. It is excellent value and should be considered as highly desirable by any reasonably serious user of Wordwise Plus. As a bonus, there are even six utilities included to help in the development of your own Wordwise Plus programs — variables lister, various crunchers and so on.

D.R.

Price: £21

Publisher: Beebugsoft

Address: PO Box 50, St Albans, Herts

**BBC**



**Decision in the Desert**

It is excellent to see a new wargame covering the World War II North African campaign in detail.

The game presents five scenarios, each covering a major battle in this campaign. Detailed scrolling maps allow the player to have a grasp of both local and overall strategy. All kinds of land forces are involved — tanks, infantry, aircraft, artillery etc — as well as all the different nations.

Commands can be issued by joystick or from the keyboard, and the game plays in accelerated real-time. There are no turns as such — units trundle about following orders set them until one player freezes the action and issues new ones. As units have an I.Q., sometimes they even act on their own initiative. The battles end when "victory conditions" are met by either side. A score and leadership rating is given.

One of the excellent aspects of this programme is that either a computer or human component can be chosen for either side. Numerous nuances have been added to facilitate gameplay. Sides can be weighted to aid novice players. Sound effects, radio messages, and the ability to redefine unit graphics and speed up/slow down play are just some of the attention to detail which Microprose have included.

Other features include changes in map colour to represent night/day, and on the XL, a flashback facility to see the highlights of the battle. Overall, a superb offering which makes this kind of wargame a joy to play.

G.C.

Price: £9.95 (cassette)  
£14.95 (disc)

Publisher: Microprose/USGold

Address: US Gold Ltd, Unit 10, Parkway Ind Centre, Heneage St, Birmingham

**ATARI**



**Sparklers Special**

This compilation of late '83 early '84 games for the Spectrum comprises four tapes: Stagecoach, Orc Attack, River Rescue and Tower of Evil.

Tower of Evil is a sub-Atic maze, search, collect and zap game with modest graphics, oversensitive controls, and breakneck speed. Orc Attack casts you as a knight atop some battlements with oil, rocks and sword to fight off the invaders who inexorably attempt to reach you with ladders, whilst bombarding you with arrows. You must therefore dodge and weave whilst employing your weapons. Quite tricky!

Stagecoach is also graphically unsophisticated. A vast scrolling yellow prairie with cactus, bones etc. as obstacles, must be traversed on your horse. Hit an obstacle and you're thrown. In the first phase you must find the stage and jump on it, then guide it through the mountains picking up passengers, gold and ammo. Finally, you must ward off the Indians. Equally tricky.

River Rescue is perhaps the best known of these games, where you have an overhead view of your boat on the river, and must guide it at enormous speed avoiding crocs 'n' rocks, picking up passengers as you go. Get far enough, and you even get bombed from a plane.

Although they are fun, none of these is up to the standard of the best £1.99 games as a result of rough edges and crude graphics. The pack shows genuine screen shots, however, so if it's what you want, then it's good value.

D.M.

Price: £7.50

Publisher: Sparklers / Thorn EMI

Address: Upper St Martin's Lane, London WC2H 9ED

**SPECTRUM**



**IF YOU USE YOUR COMPUTER TO  
PLAY GAMES, THEN YOU CAN'T  
AFFORD TO MISS.**

*Computer*

**GAMER**

This fantastic new magazine appears on the fourth Friday of every month price of 95p.

Each issue will be produced in cooperation with Eecaan our Interplanetary Adviser who on his home planet, Aargon, is a member of the Association of Supreme Players. He will be monitoring developments in the games industry and advising Computer Gamer readers with all their gaming problems. Included in each issue will be pages of review of the latest games releases, special Adventure features and a help-line, invaluable articles on how to 'crack' specific games a high-score page, exciting programs to type in for most of the popular home computers, news, competitions, reviews of peripherals and computers themselves if relevant to the games field and LOTS more.

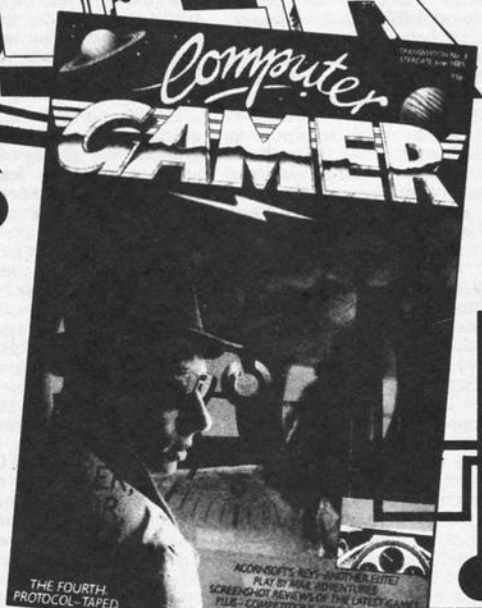

Also, all readers of Computer Gamer will have the opportunity to join our tremendous Reader's Club — each member will receive a membership card and a regular newsletter which will contain up-to-the-minute news and all sorts of offers on a variety of products.

So all-in-all there's no way you can afford to be left out of the great new revolution in games computing — rush out and buy your copy NOW!

# READER OFFERS

*These pages can be worth nearly £100!  
There's money off coupons for nearly  
every home computer so there's no  
excuse for not saving a packet*

**PENNIES FROM  
HEAVEN AND  
£££S IN  
YOUR POCKET**

**50%**

**OFF  
SOFTWARE  
FROM A'N'F**

**DON'T WASTE  
TIME SAVING THE  
COSMOS WHEN  
YOU COULD BE  
SAVING UP TO**

**£6**

**ON KOSMOS  
SOFTWARE**

# READER OFFER

This week we present the first of our Reader Offer Spectaculars. Using the coupons on this page could save you nearly £100 — £97.65 to be precise.

There's offers for owners of all the most popular home computers and on a huge variety of software and hardware. First, in the hardware selection is the Metron Audio Speech synthesis unit for the BBC which was highly rated in our review. BBC owners can save £5 on that unit!

There are adventure games for dungeon enthusiasts, arcade games for those with itchy fingers, quiz games for those with time to spend on trivial matters and educational games

for the younger members of the family.

There are eight software products on offer for Acorn owners, nine for Spectrum owners, six for Commodore users and one each for Amstrad and Dragon owners. The offers come from a variety of big names too: A 'n' F, Kosmos, CCS, Mirrorsoft and Addison-Wesley. We think that you'll find them very hard to miss — so find those scissors, cut your coupons, send your order and grab a bargain!

Full details of how to order the products are given on each coupon, please note that orders should not be sent to our editorial address. You should

keep a record of your order, cheque/postal order numbers, data posted and the address you posted your order to, in case you need to make any enquiries.

If there is nothing that you fancy this week, start saving your pennies! This is only the first of three special editions of HCW, each containing coupons for huge discounts on computer products. Look out for offers from Virgin Games, Saga Systems, Gemini Software and many other major suppliers — all yours for the asking.

Don't forget about your free Magazine cassette tape offer and the special subscription deal. HCW is the great one for value!

## KOSMOS SOFTWARE

Mail this coupon with your payment to: Kosmos Software, 1 Pilgrims Close, Harlington, Dunstable, Beds LU5 6LX

Qty	Product	Machine	RRP	Saving	Our Price	Order Value
___	Answerback Sport	BBC/ Elec	£9.95	£2	£7.95	___
___	Answerback Junior	BBC/ Elec	£9.95	£2	£7.95	___
___	Answerback Senior	BBC/ Elec	£9.95	£2	£7.95	___

I wish to order the goods detailed above and enclose a cheque or postal order to the value £\_\_\_\_\_ payable to KOSMOS SOFTWARE

Name \_\_\_\_\_

Address \_\_\_\_\_

Post Code \_\_\_\_\_

Offers end 24th December 1985 or whilst stocks last.

## A'N'F

Mail this coupon with your payment to: A'n'F Software, Unit 8 Canalside Ind Est, Woodbine St East, Rochdale, OL16 5LB

Qty	Product	Machine	RRP	Saving	Our Price	Order Value
___	Cyclon Attack	BBC	£7.90	50%	£3.95	___
___	Haunted Abbey	BBC	£6.90	50%	£3.45	___
___	Copter Capers	BBC	£6.90	50%	£3.45	___
___	Orpheus	BBC	£6.90	50%	£3.45	___
___	Gumshoe	C64	£7.90	50%	£3.95	___
___	Screaming Ab Dabs	Dragon	£6.90	50%	£3.45	___
___	Cyclon Attack	Elect	£7.90	50%	£3.95	___
___	Cyclon Attack	Spec	£5.95	50%	£2.88	___
___	AlphaBeth	Spec	£5.75	50%	£2.88	___
___	AlphaGen	Spec	£5.75	50%	£2.88	___

I wish to order the goods detailed above and enclose a cheque or postal order to the value £\_\_\_\_\_ payable to

A'N'F SOFTWARE

Name \_\_\_\_\_

Address \_\_\_\_\_

Post Code \_\_\_\_\_

Offers end 24th December 1985 or whilst stocks last.

**LOST FOR WORDS?**

**YOU WON'T BE  
WITH THIS  
£5 VOUCHER  
FOR  
VOICE  
MASTER'S  
BBC SPEECH  
SYNTHESISER**

**WHY BE HARD-  
BOILED WHEN  
YOU COULD SAVE  
OVER**

**50%  
ON**

**MIRRORSOFT'S  
STAR EGGS AND  
CATASTROPHES**

**1  
2 price**

**GAME OFFER ON  
FOUR TITLES  
FROM**

**ADDISON-  
WESLEY**

**SAVE OFF**



**SELECTED TITLES  
FROM**

**CCS**

**INCLUDING  
WAR ZONE,  
MAVERICK AND  
MANY MORE....**

# ADDISON- WESLEY

Mail this coupon with your payment to: Addison-Wesley, Finchampstead Rd, Wokingham, Berks RG11 2NZ

Qty	Product	Machine	RRP	Saving	Our Price	Order Value
___	Military Coup	C64	£14.95	50%	£7.48	___
___	Dreadnought	C64	£14.95	50%	£7.48	___
___	Waterloo	C64	£16.95	50%	£8.46	___
___	Front Page	C64	£16.95	50%	£8.46	___

I wish to order the goods detailed above and enclose a cheque or postal order to the value £\_\_\_\_\_ payable to ADDISON-WESLEY

Name \_\_\_\_\_  
Address \_\_\_\_\_

Post Code \_\_\_\_\_

Offers end 24th December 1985 or whilst stocks last.

# METRON AUDIO

Mail this coupon with your payment to: Metron Audio, 7 Delilah Rd, Hamworthy, Poole, Dorset BH15 4NR

Qty	Product	Machine	RRP	Saving	Our Price	Order Value
___	Voice Master Speech Synth	BBC	£37.75	£5	£32.75	___

I wish to order the goods detailed above and enclose a cheque or postal order to the value £\_\_\_\_\_ payable to METRON AUDIO

Name \_\_\_\_\_  
Address \_\_\_\_\_

Post Code \_\_\_\_\_

Offers end 24th December 1985 or whilst stocks last.

# CCS

Mail this coupon with your payment to: Cases Computer Simulations, 14 Langton Way, Blackheath, London SE3 7TL

Qty	Product	Machine	RRP	Saving	Our Price	Order Value
___	Nato Alert	Spec	£5.95	£2	£3.95	___
___	Maverick	Spec	£5.95	£2	£3.95	___
___	Super Power	Spec	£5.95	£2	£3.95	___
___	Air Descent	Spec	£5.95	£2	£3.95	___
___	The Open	Spec	£5.95	£2	£3.95	___
___	War Zone	Spec	£5.95	£2	£3.95	___
___	War Zone	Amst	£6.95	£2	£3.95	___

I wish to order the goods detailed above and enclose a cheque or postal order to the value £\_\_\_\_\_ payable to CCS SOFTWARE

Name \_\_\_\_\_  
Address \_\_\_\_\_

Post Code \_\_\_\_\_

Offers end 24th December 1985 or whilst stocks last.

# MIRRORSOFT

Mail this coupon with your payment to: Mirrorsoft, Maxwell Hse, Worship St, London EC2A 2EN

Qty	Product	Machine	RRP	Saving	Our Price	Order Value
___	Star Eggs and Catastrophies	C64	£13.90	£9.91	£3.99	___

I wish to order the goods detailed above and enclose a cheque or postal order to the value £\_\_\_\_\_ payable to MIRRORSOFT

Name \_\_\_\_\_  
Address \_\_\_\_\_

Post Code \_\_\_\_\_

Offers end 24th December 1985 or whilst stocks last.

## DICEY BUSINESS

*It's a question of shooting the dice — and not the aliens — in this 48K Spectrum game from Andrew Bird*

"Lucky in cards — unlucky in love" goes the old adage. Happily there are no cards in this game — only dice — so you can be lucky in both!

In the quickest time possible you have to find the odd one out of 15 dice, the remaining 14 will form seven pairs. You have three attempts at the task and your best time providing you guess correctly, will be announced at the end.

**How it works**

1-95 initialise variables etc  
100-175 main loop of 3 attempts  
400-590 draws dice  
600-680 your guess is checked  
700-750 odd dice revealed  
800-890 best reaction time indicated  
7000-7150 instructions  
9000-9160 graphics  
9500-9510 m/code sound  
9900 re-sets clock

**Variables**

so address of m/code for sound effects  
FN t() clock  
DIM r reaction times  
DIM d picks eight different dice to be printed  
DIM p picks positions where to be printed  
DIM ds holds graphic characters making up dice  
DIM x} co-ords of boxes  
DIM y}  
l main loop (3 goes)  
d1} used to shuffle up dice into  
d2} various boxes  
odd number of box in which odd dice printed  
is your guess input  
time time it takes you  
best best time of the 3  
is instructions  
f}  
n} general purpose loops  
d}

```

1 REM *** DICED PAIRS ***
2 REM By Andrew Bird 185
4 LET so=50000: GO SUB 9500
5 DEF FN t()=INT ((65536*PEEK
23674+256*PEEK 23673+PEEK 23672
)/50)
6 GO SUB 7000
7 RANDOMIZE
8 POKE 23609,30: POKE 23658,8
10 DIM r(3): REM reaction time
12 DIM d(8): REM dice printed
14 DIM p(15): REM shuffle
19 REM * DIMENSION ARRAYS *
20 DIM d$(10,9)
30 RESTORE 40: FOR f=1 TO 10:
READ z$: LET d$(f)=z$: NEXT f
40 DATA "bcgjmqsvy","adhjmqsvz
","begjoquvy","adflmpsy","adhkn
rtwz"
50 DATA "acfknqtwy","beilopuxz
","bcglopuxy","achloquxz","bdilo
ruxz"
80 DIM x(15): DIM y(15)
90 RESTORE 95: FOR f=1 TO 15:
READ a,b: LET x(f)=a: LET y(f)=b
: NEXT f
95 DATA 3,2,3,8,3,14,3,20,3,26
,9,2,9,8,9,14,9,20,9,26,15,2,15,
8,15,14,15,20,15,26
99 REM ** MAIN LOOP **
100 FOR l=1 TO 3
130 FOR f=1 TO 8
140 LET d1=INT (RND*10)+1
150 FOR n=1 TO f
160 IF d(n)=d1 THEN GO TO 140
170 NEXT n
180 LET d(f)=d1: NEXT f
200 FOR f=1 TO 15
210 LET d2=INT (RND*15)+1
220 FOR n=1 TO f
230 IF p(n)=d2 THEN GO TO 210
240 NEXT n
250 LET p(f)=d2: NEXT f
260 LET odd=p(15)
380 POKE 23606,56: POKE 23607,1
98
390 BORDER 7: PAPER 7: INK 7: C
LS
399 REM ** DRAW GAME **
400 FOR f=1 TO 13 STEP 2
410 PRINT AT x(p(f))+1,y(p(f))+
1;d$(d((INT f+1)/2))(1 TO 3)
415 PRINT AT x(p(f+1))+1,y(p(f+
1))+1;d$(d((INT f+1)/2))(1 TO 3)
420 PRINT AT x(p(f))+2,y(p(f))+

```



```

1;d$(d((INT f+1)/2))(4 TO 6)
425 PRINT AT x(p(f+1))+2,y(p(f+
1))+1;d$(d((INT f+1)/2))(4 TO 6)
430 PRINT AT x(p(f))+3,y(p(f))+
1;d$(d((INT f+1)/2))(7 TO 9)
435 PRINT AT x(p(f+1))+3,y(p(f+
1))+1;d$(d((INT f+1)/2))(7 TO 9)
450 NEXT f
460 PRINT AT x(p(15))+1,y(p(15)
)+1;d$(d(8))(1 TO 3);AT x(p(15)
)+2,y(p(15))+1;d$(d(8))(4 TO 6);A
T x(p(15))+3,y(p(15))+1;d$(d(8)
)(7 TO 9)
480 FOR f=0 TO 21: PRINT AT f,0
; INK 1; OVER 1;"
      ": NEXT f
500 PRINT AT 0,0; PAPER 6; INK
0;" DICED PAIRS "; PAPER 5;" BY
ANDREW BIRD "
510 INK 4: FOR f=8 TO 248 STEP
48: PLOT f,16: DRAW 0,144: NEXT
f
520 FOR f=16 TO 160 STEP 48: PL
OT 8,f: DRAW 240,0: NEXT f
530 INK 1
540 FOR f=1 TO 15
550 POKE 23606,0: POKE 23607,60
560 PRINT AT x(f),y(f); INK 3;C
HR$(64+f)
570 NEXT f
590 GO SUB 9900
599 REM ** YOUR GUESS **
600 INPUT " WHICH IS THE ODD DI
CE ? "; LINE 1$
605 IF CODE (1$)-64=odd THEN G
O TO 650
610 FOR f=2 TO 8: POKE so+7,f
615 FOR n=1 TO 20: POKE so+18,1
00+n
620 LET d=USR so: NEXT n: NEXT
f
630 PRINT AT 21,1;"THE ODD DICE
IS IN BOX "; INK 3;CHR$(64+od
d)
640 LET r(1)=99999: GO TO 700
650 LET time=FN t()
655 PRINT AT 21,30; PAPER 6; IN
K 1; FLASH 1;" ";AT 21,0;" CORR
ECT ANSWER IN ";time;" SECONDS !
"
660 LET r(1)=time
670 POKE so+7,20: FOR f=1 TO 50
675 POKE so+18,110-f*2
680 LET d=USR so: NEXT f
699 REM * ODD DICE REVEILED *
700 POKE 23606,56: POKE 23607,1
98
710 PRINT AT x(p(15))+1,y(p(15)

```

```

)+1; INK 2;d$(d(8))(1 TO 3);AT x
(p(15))+2,y(p(15))+1;d$(d(8))(4
TO 6);AT x(p(15))+3,y(p(15))+1;d
$(d(8))(7 TO 9)
750 NEXT 1: FOR d=1 TO 600: NEX
T d
799 REM * REACTION TIMES *
800 IF r(1)<=r(2) AND r(1)<=r(3
) THEN LET best=r(1)
810 IF r(2)<=r(1) AND r(2)<=r(3
) THEN LET best=r(2)
820 IF r(3)<=r(1) AND r(3)<=r(2
) THEN LET best=r(3)
825 BORDER 3: PAPER 3: INK 0: C
LS
830 FOR f=6 TO 16: PRINT AT f,8
; PAPER 7;"      ": NEX
T f
835 IF best<>99999 THEN GO TO
850
840 PRINT AT 7,9; PAPER 7; INK
2;"AFTER THREE";AT 9,9;"ATTEMPTS
YOU";AT 11,9;"HAVE FAILED";AT 1
3,9;"TO IDENTIFY";AT 15,9;"AN OD
D DICE"
845 BEEP 1,-30: GO TO 880
850 PRINT AT 7,9; PAPER 7;"YOUR
QUICKEST";AT 9,9;"REACTION TIME
";AT 11,9;"WAS ";best;" SECS.";A
T 13,9;"PRESS ANY KEY";AT 15,9;"
TO PLAY AGAIN"
860 POKE so+7,40: FOR f=1 TO 50
870 POKE so+18,110-f*2
875 LET d=USR so: NEXT f
880 IF INKEY$<>" THEN CLS : G
O TO 100
890 GO TO 880
6999 REM ** INSTRUCTIONS **
7000 LET i$="THE IDEA OF THIS GA
ME IS TO SEE HOW QUICKLY YOU CAN
SPOT THE ODDDICE OUT OF THE 15
DRAWN FOR YOU BY THE COMPUTER.
      MOST OF THEM WILL P
AIR UP WITH "
7010 LET i$=i$+"ANOTHER THE SAME
BUT 1 WILL NOT.YOU WILL BE GIVE
N THREE GOES ANDYOUR REACTION TI
ME WILL BE NOTEDFOR EACH ATTEMPT
. Good luck ! "
7015 POKE 23606,0: POKE 23607,60
7020 BORDER 5: PAPER 5: INK 0: C
LS
7030 FOR f=18 TO 2 STEP -2
7050 PRINT AT f,0;i$(f*16-31 TO
f*16)
7060 LET d=USR so
7070 NEXT f
7080 PRINT AT 0,0; PAPER 6;" DIC

```



```

ED PAIRS By Andrew Bird "
7090 GO SUB 9000
7100 PRINT AT 20,0; PAPER 6;"
Press any key to begin "
7120 BEEP .02,50
7130 IF INKEY$<>" THEN CLS : L
ET d=USR so: RETURN
7150 GO TO 7130
8999 REM ** GRAPHICS **
9000 FOR f=0 TO 768
9010 POKE 51000+f,PEEK (15616+f)
9020 NEXT f
9050 RESTORE 9100: FOR f=0 TO 20
7: READ a: POKE 51520+f,a: NEXT
f: RETURN
9100 DATA 0,1,2,4,8,16,32,64,0,1
,2,4,8,16,38,64,255,0,0,0,24,0,0
,0,255,0,96,0,0,0,6,0
9110 DATA 255,0,102,0,0,102,0,
252,2,5,9,17,33,65,129,252,2,101
,9,17,33,65,129,252,2,5,9,17,37,
69,129
9120 DATA 252,2,101,9,17,37,69,1
29,127,128,128,128,128,128,128,1
29,127,128,128,152,152,128,128,1
28,127,128,128,152,152,128,128,1
    
```

```

29
9130 DATA 254,1,1,1,1,1,1,1,1,29,25
4,1,1,25,25,1,1,1,254,1,1,25,25,
1,1,1,29,1,1,1,17,17,1,1,1
9140 DATA 1,65,65,1,1,5,5,1,1,69
,69,1,1,69,69,1,1,29,128,128,128,
128,128,128,127,128,128,128,152,
152,128,128,127
9150 DATA 129,128,128,152,152,12
8,128,127,129,1,1,1,1,1,1,254,1,
1,1,25,25,1,1,254,129,1,1,25,25,
1,1,254
9160 DATA 2,4,8,16,32,64,128,0,2
,68,72,16,32,64,128,0
9499 REM ** M/CODE SOUND **
9500 RESTORE 9510: FOR f=0 TO 30
: READ a: POKE so+f,a: NEXT f: R
ETURN
9510 DATA 58,72,92,31,31,31,6,20
,14,254,37,32,6,238,16,237,121,3
8,99,45,32,244,238,16,237,121,46
,250,16,236,201
9899 REM ** SET CLOCK **
9900 POKE 23674,0: POKE 23673,0:
POKE 23672,0: RETURN
9999 SAVE "DicedPairs" LINE 1
    
```

## HCW needs you

Have you ever looked at the articles and programs in HCW and thought you could have written that?

Why not try? We welcome submissions from readers and are always interested in your ideas and suggestions.

Submissions tend to fall into one of three categories...

**Programs** are always supplied on cassette and are accompanied by full details of the program variables. Please type these details double-spaced. Listings are helpful, but not essential. What is vital is that the programs should be completely error free, so please double check.

**Articles** on certain aspects of using home computers should be no longer than 1000 words. Try to keep to the style you see in HCW and include programming examples where they will help the reader understand the subject. We will convert your sketched illustrations into final artwork.

We also use **short tips**, articles and brief programming routines. Any discoveries you have made about your machine might be of interest to other readers.

All contributions are acknowledged and those accepted for publication are paid for at competitive rates. The copyright in such work will pass to Argus Specialist Publications Ltd. Keep a copy of your work and include a telephone number and an SAE. Please label everything clearly with your name and the machine concerned.

All contributions should be sent to:

Submissions  
Home Computing Weekly  
No.1 Golden Square London W1R 3AB

## GOOD BYTE

SPECTRUM			
GAME	RRP	OUR PRICE	
BORDERFORS SHADOW	8.95	7.45	
HIGHWAY ENCOUNTER	7.95	5.95	
NICK FALDO	9.95	7.45	
TALOS	5.95	7.95	
FRANKIE GOES TO HOLLYWOOD	9.95	7.95	
A VIEW TO A KILL	10.99	8.25	
SPY VS SPY	5.99	5.95	
STARION	7.95	5.95	
HYPERSPORTS	7.95	5.95	
DALEY'S SUPERTEST	6.95	5.20	
SHADOWFIRE	9.95	7.45	
NODES OF YESOD	9.95	7.45	
FRANK BRUNO BOXING	6.95	5.20	
DYNAMITE DAN	6.95	5.20	
RAM TURBO INTERFACE	22.95	17.99	
NIGHTSHADE	8.95	7.45	
ROBIN OF SHERWOOD	9.95	7.45	
WAY OF THE EX. PIST	8.95	6.50	
ROCKFORD'S RIOT	9.95	7.45	
FARLIGHT	9.95	7.45	
THAT'S THE SPIRIT	7.95	5.95	
SOUTHERN BELLE	6.95	5.20	
RED ARROWS	8.95	6.70	
INT. BASKETBALL	5.95	4.45	
BORNE OF THE RINGS	6.95	5.20	
CYLU	2.50	1.80	
J.S.W. II	6.95	5.20	
STARBUCKE	7.95	5.95	
SHADOW OF UNICORN	14.95	11.20	
TRIVA	8.95	6.70	
TERRORMOLINS	6.95	5.20	
WORLD SERIES B'BALL	6.95	5.20	
CALLIDRON	5.95	7.45	
ROCCO	7.95	5.95	
MARSPOUT	9.95	7.45	
FIGHTING WARRIOR	7.95	5.95	
GRAHAM GOOCH	6.95	6.70	

COMMODORE 64			
GAME	RRP	OUR PRICE	
UNDERWURLDE	9.95	7.45	
NICK FALDO	9.95	7.45	
FRANKIE GOES TO HOLLYWOOD	9.95	7.45	
WAY OF THE EXPLODING PIST	9.95	7.45	
ELITE	14.95	11.20	
G. GOOCH TEST CROCKET	9.95	7.45	
HYPERSPORTS	8.95	6.70	
SHADOWFIRE	9.95	7.45	
SHADOWFIRE (Disc)	13.95	10.45	
J.S.W. II	6.95	5.20	
DALEY T. SUPERTEST	7.95	5.95	
ROCKFORD'S RIOT	9.95	7.45	
FRANK BRUNO	7.95	5.95	
ROBIN OF SHERWOOD	9.95	7.45	
NODES OF YESOD	9.95	7.45	
BLUE MAX 201	9.95	7.45	

AMSTRAD			
GAME	RRP	OUR PRICE	
SORCERY	8.95	6.70	
COMBAT LYNX	8.95	6.70	
CLIN DARTON	8.95	6.70	
DALEY THOMPSON DECATHLON	8.95	6.70	
FRANK BRUNO	8.95	6.70	
EXPLODING PIST	8.95	6.70	
A VIEW TO A KILL	10.99	8.25	
STARION	9.95	7.45	
EVERYONE'S A WALLY	9.95	7.45	
DRAGONTRIC	7.95	5.95	
ROCCO	8.95	6.70	
WIZARD'S LAIR	8.95	6.70	
PROJECT FUTURE	8.95	6.70	
THEATRE EUROPE	9.95	7.45	
DRAGONTRIC	7.95	5.95	
FIGHTING WARRIORS	7.95	5.95	
BRIAN BLOODAKE	8.95	6.70	
SLAF SHOT	8.95	6.70	
TRIVA	7.95	5.95	
SORCERY + (Disc)	13.95	10.45	
DEVILS CROWN	7.95	5.95	
HIGHWAY ENCOUNTER	7.95	5.95	

QUICKSHOT II NOW ONLY 65.50	
ALL PRICES INCLUDE P&P	
Goodbyte offers some of the most competitive prices for software available. If you don't see the game you require listed, please ring for the most up-to-date news on releases and back catalogue files on 01-484 4245.	
PLEASE NOTE IF OUR ORDER EXCEEDS 150	
YOU GET 10% FURTHER DISCOUNT	
SEND CHEQUE/P.O. TO	
UNIT 1911	
IMPERIAL STUDIOS, IMPERIAL ROAD	
LONDON SW6 (TEL: 01-721 4607)	

C O M P E

SCORE: 01500 04 HI-SCORE: 00500

SCORE: 01600

Das Boat

SCORE: 00500

RUN MONTY RUN



October

£7.95

£9.95

**Gremlin Graphics are offering prizes galore to the 25 winners of this week's Monty Mole competition**

**M**onty the Mole is back and with a vengeance. He has broken out of jail and is on the run!

If you want to try to catch him, there are 25 prizes in this week's competition and each one will include a copy of the new Monty on the Run game. There are versions for Amstrad, Spectrum and Commodore owners and each prize will include two other Gremlin Graphics games, making the packs worth over £20 each.

As an added bonus, for the first entry out of the hat there will be a cuddly Monty Mole figure complete with little red shovel. All that you have to do is find the differences between the cartoons below, but before you do read on and discover more about Monty and his adventures.

It all started over a year ago with our hero trying to grasp a little warmth from the local coat pit — Monty lives in South Yorkshire you understand. After getting lost underground he finds himself in Arthur's Castle and from there it's prison for him.

Scudmore prison is not a pretty place and so Sam Stoad decides to try to free his small rodent friend, in the second game of the series Monty is Innocent. There are many dangers in the prison and Sam has to brave them all looking for the keys which will lead to Monty's release.

After his release Monty finds himself a free man again. He isn't a happy mole however and he spends all his time trying to find the various objects and money that he needs to ensure that he remains a free man for a long time.

This game is quite a gem. Computer Gamer called it "a little masterpiece" and "an exceptional game" so there is every incentive to try to win our competition. Spectrum winners will receive the whole set of Monty games, Amstrad owning winners will get Monty on the Run, Rocco and Metabolis, whilst Commodore owners will have Monty on the Run, Potty Pidgeon and Thing on a Spring.

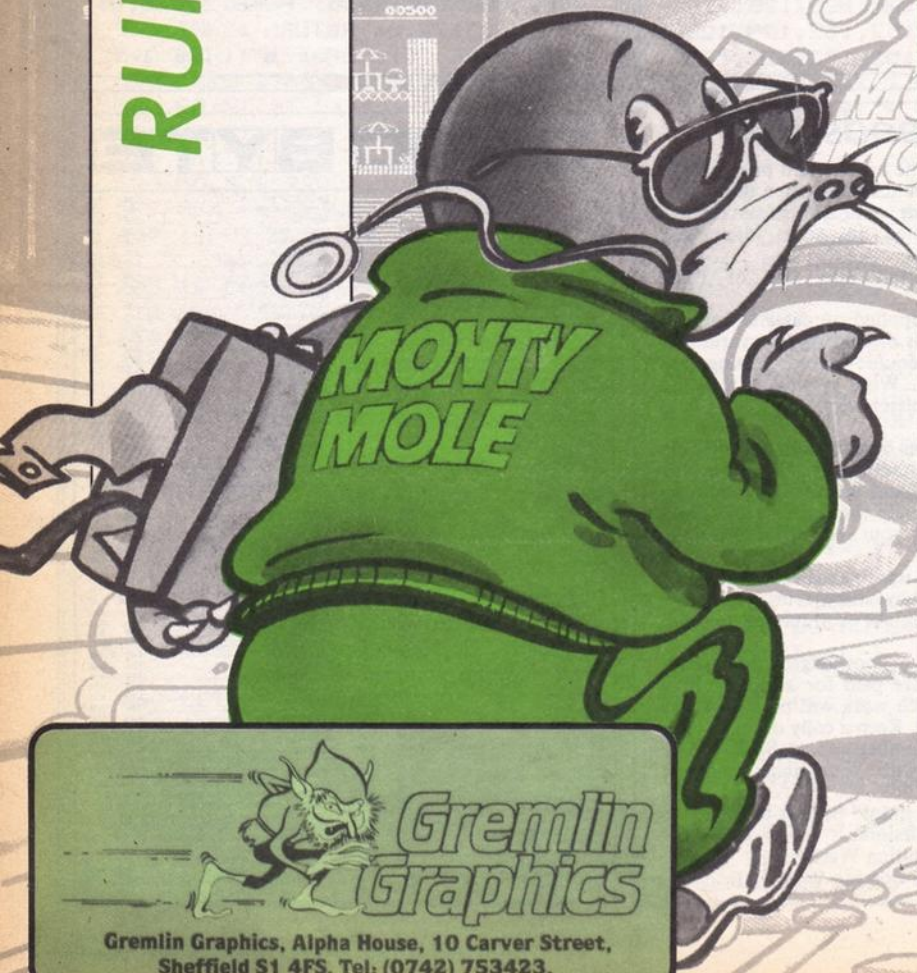

**Gremlin Graphics**

Gremlin Graphics, Alpha House, 10 Carver Street, Sheffield S1 4FS. Tel: (0742) 753423.



## Monty Mole Competition

### Entry Coupon

Name \_\_\_\_\_

Address \_\_\_\_\_

\_\_\_\_\_

\_\_\_\_\_

post code \_\_\_\_\_

Number of differences found \_\_\_\_\_

I own a Spectrum / Amstrad / Commodore

Complete clearly and fully — if you win a prize this coupon will become your address label. Post to: Monty Mole Competition, Home Computing Weekly, No 1 Golden Square, London W1R 3AB. Closing date: first post on Friday 1st November 1985. Please remember to write the number of differences on the back of your envelope.

#### How to enter

- Study the two cartoons — there are a number of differences between them. Circle the differences on cartoon B and seal the cartoon and coupon in an envelope. Remember to write clearly the number of differences you found on the back of the envelope.

- Post your entry to Monty Mole Competition, Home Computing Weekly, No 1 Golden Square, London W1R 3AB. Entries close at first post on Friday 1 November 1985.

- You may enter as many times as you wish, but each entry must be on an official coupon — not a copy — and sealed in a separate envelope.

- **Important:** please follow carefully the guidelines on entering — incomplete coupons and entries in envelopes with no numbers on the back cannot be considered. If you are a winner, the coupon will be used as a label to send your prize, so clear writing is essential.

#### The rules

- Entries will not be accepted from employees of Gremlin Graphics, Argus, Specialist Publications and Alabaster Passmore & Sons. This restriction also applies to employee's families and agents of the companies.

- The How to enter section forms part of the rules.

- The editor's decision is final and no correspondence can be entered into.

IT!

CODE

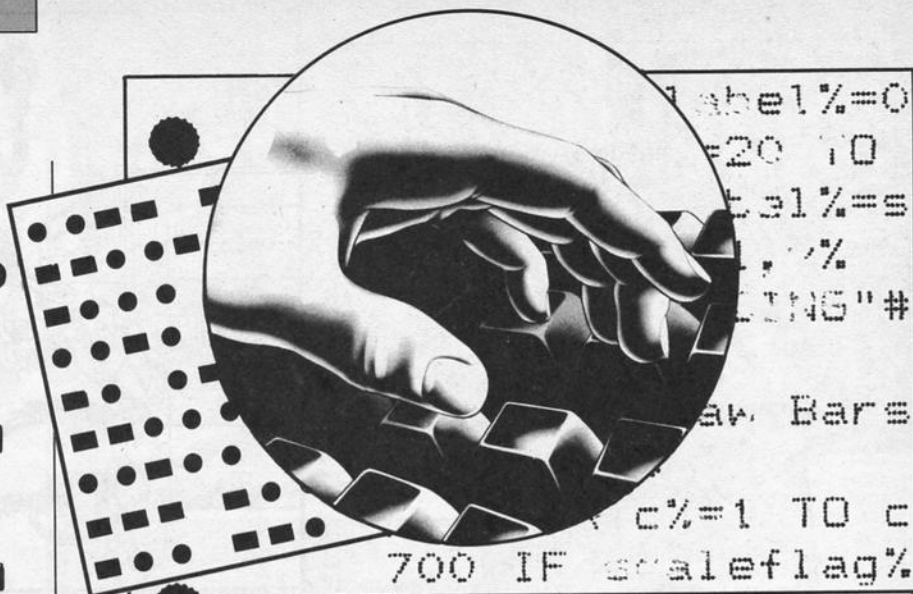

***It's time to mark the homework and find the register in this week's exciting episode of Alan Webb's machine code soap opera***

Hello again folks, how did you get on with the exercises in the last part? Here are the answers:

1. a). 4348  
b). 109  
c). 827  
d). 19
2. a). %11001  
b). %100101
3. a). \$FF  
b). \$1001
4. %01010000000011110

Sorry that part one was rather dry, this time we will actually start writing programs.

Before we can write a program, however, we must discover what the 65xx micros comprise of and how they do what they do. First, a silly tip. I find it easy to envisage the micro-processor and the rest of the computer as a collection of match boxes. Nearly all of these boxes will accommodate an eight bit number, the exception being the program counter. Using this analogy can help follow what is going on.

After last month's section on binary, you should appreciate the significance of an eight bit number. An eight bit number ranges between %00000000 and %11111111 (ie from 0 to 255). This is the basic limitation of the resolution of the 65xx

micros. You may have already come across this limitation when trying to poke a value greater than 255 into a memory location.

One other necessary area requiring clarification is the concept of memory pages. The designers of the 65xx micros found it convenient to split up RAM into blocks of 256 bytes or pages. The RAM from address 0 to 255 is called "zero" page (\$00 to \$FF). The RAM from address 256 to 511 (\$0100 to \$01FF) is called page "one" and so on. Zero page has a particular significance, as we will see later, by offering a faster mode of operation.

So on with the show, what does a 65xx do? Well, it performs a series of simple operations which are held in memory as one, two or three byte codes. This, as you must have guessed, is machine code. The micro keeps track of the address of the operation currently in hand by use of a, 16 bit, program counter.

A work area or scratch pad is useful to allow the temporary storage of data. The 65xx uses page "one" as a "last in first out" stack. The current working position in the stack is held in a register called the "Stack Pointer". I'll discuss the use of the stack in greater detail in a later part of this series.

I have no intention of baffling you with great detail about the internal workings of the 65xx. The basic operations are centred on four eight bit registers: the Accumulator, X register, Y register and the Status register. The first three play a vital role in the access and manipulation of data.

The Status register holds seven flags and allows the monitoring of the micro's operation and the control of the program flow. Simple addition, subtraction and logic operations are possible and these are carried out in the Arithmetic Logic Unit. An appreciation of these basic concepts should be sufficient for the routine programming of the 65xx. There does remain the feature of interrupts, but these will be covered at a later date.

Unlike the clever micro, we stupid humans find it difficult to work in numbers. The creation of machine code by direct use of the relevant code values, numbers to you, is both difficult and slow. To aid programming, mnemonics are available for the various operations. Load Accumulator, for example, has the mnemonic LDA. Here are some other examples:

STA....Store Accumulator  
CLC....Clear Carry Flag  
RTS....Return from subroutine

If you study the source codes given in this article you will see the mnemonics in column 6. The full code comprises the mnemonic followed by an operand. The operand will be

```

ASSEMBLER 64 V2.0      PAGE 1
20:      5000                .OPT P4
30:      5000                *- $5000
35:      ;
40:      ; IMMEDIATE ADDRESSING MODE
45:      ;
50:      5000 A9 03          LDA #03
55:      5002 A9 03          LDA #$03
60:      5004 A9 03          LDA #%00000011
65:      ;
70:      ; ABSOLUTE ADDRESSING MODE
75:      ;
80:      5006 AD 00 04        LDA 1024
90:      5009 AD 00 04        LDA $0400
100:     ;
120:     500C 8D 00 04        STA 1024
130:     500F 8D 00 04        STA $0400
140:     ;
150:     5012 AE 00 04        LDX 1024
160:     5015 AC 00 04        LDY $0400
170:     ;
180:     5018 BE 00 04        STX $0400
190:     501B BC 00 04        STY 1024
200:     ;
210:     ; ZERO PAGE ADDRESSING
220:     ;
230:     501E A5 01          LDA 1
240:     5020 A6 01          LDX 1
250:     5022 A4 01          LDY 1
260:     ;
270:     5024 85 01          STA 1
280:     5026 86 01          STX 1
290:     5028 84 01          STY 1
J5000-502A
    
```

an eight bit number, or an eight or sixteen bit address. If the operand is a sixteen bit number, it is stored, by convention, with the second eight bits (least significant) followed by the first eight (most significant) bits. Consider line 130 of listing 1:

```
8D 00 04  STA$0400
```

8D is the hexadecimal code for LDA a 00 04 is the address involved in the command. These three bytes are the machine code.

With an assembler you write the mnemonics. The assembler then converts it into the code. The first number following the line number is the address at which each piece of code is assembled. The list of mnemonics is called the source code and the assembled lump of machine code is called the object code.

The 65xx supports 13 addressing modes offering a wide range of possibilities. Most of the commands operate in several of these modes. The most frequently used operations involve the movement of data. Example 1 gives some of the simpler modes. The Accumulator, X register and Y register can all be loaded with an eight bit value.

Firstly you can load a numeric value in Immediate mode. This is signified by preceding the operand by #, for example:

```
LDX
LDA # $122
```

The first example loads the X register with \$40 (hexadecimal) and the second loads the Accumulator with 122 (decimal).

Alternatively, you can load the registers with the value held in a memory location. This is called Absolute mode:

```
LDT $0400
LDA 10
```

The first example loads the Y register with contents of location \$0400 and the second loads the Accumulator with the contents of location 10. If you wish to load the register from a zero page location (zero page mode), the operation is faster than in normal Absolute mode.

The converse of load operations involve storing. This does not function in Immediate mode since you can only store in a memory location. The

Absolute mode commands are:

```
STA $0400
STX 21
STY %00000011
```

A zero option also exists for store. These three modes of operation are summarised in Example 1. I've used the different bases to show their implementation.

Example 2 is a trivial routine showing how to use these commands. The accumulator is

first loaded with the value one (Immediate mode). This is then stored in location 1024 and 55296. The routine simply puts a white A in the top left corner of the screen. The BASIC equivalent of the program is:

```
10 LDA # 1 : ACC = 1
20 STA 1024 : POKE 1024,ACC
30 STA 55296 : POKE 55296,ACC
40 RTS : RETURN
```

A second example to change

```

ASSEMBLER 64 V2.0      PAGE 1
7:      ;
8:      ; LISTING 1
9:      ;
10:     C000                .OPT P4
20:     C000                *= $C000
30:     ;
40:     ; IMMEDIATE ADDRESSING MODE
50:     ;
60:     C000 A9 03          LDA #03
70:     C002 A9 03          LDA #$03
80:     C004 A9 03          LDA #%00000011
90:     ;
100:    ; ABSOLUTE ADDRESSING MODE
110:    ;
120:    C006 AD 00 04        LDA 1024
130:    C009 AD 00 04        LDA $0400
140:    ;
150:    ;
160:    C00F 8D 00 04        STA 1024
170:    C012 8D 00 04        STA $0400
180:    ;
190:    ;
200:    C018 AE 00 04        LDX 1024
210:    C01B AC 00 04        LDY $0400
220:    ;
230:    C01E AE 00 04        STX 1024
240:    C021 BC 00 04        STY $0400
250:    ;
260:    ; ZERO PAGE ADDRESSING
270:    ;
280:    C024 A5 01          LDA 1
290:    C026 A6 01          LDX 1
300:    C028 A4 01          LDY 1
310:    ;
320:    C02A 85 01          STA 1
330:    C02C 86 01          STX 1
340:    C02E 84 01          STY 1
JC000-C030
    
```

```

ASSEMBLER 64 V2.0      PAGE 1
10:     C000                *= $C000
20:     C000                .OPT 00 P4
30:     C000 A9 01          LDA #1 ; LOAD ACCUMULATOR WITH 1
40:     C002 8D 00 04        STA 1024 ; PUT ACCUMULATOR CONTENTS IN LOCATIO
N 1024
50:     C005 8D 00 04        STA 55296 ; PUT ACCUMULATOR CONTENTS IN LOCATIO
N 55296
60:     C006 60                RTS ; RETURN TO BASIC
JC000-C009
    
```

the current colour to red might be:

```
10 LDX # 2 : X = 2
20 STX 646 : POKE 646,X
30 RTS : RETURN
```

An allied set of commands allow the transfer of data between the registers. These operate in only one mode (Implied mode) and have no operand. The commands are:

- TAX....Transfer Accumulator to X register
- TXA....Transfer X register to Accumulator
- TAY....Transfer Accumulator to Y register
- TYA....Transfer Y register to Accumulator

These operations actually copy data from one register to the other, leaving the contents of the source and destination registers the same.

Generally the accumulator is used for most operations since

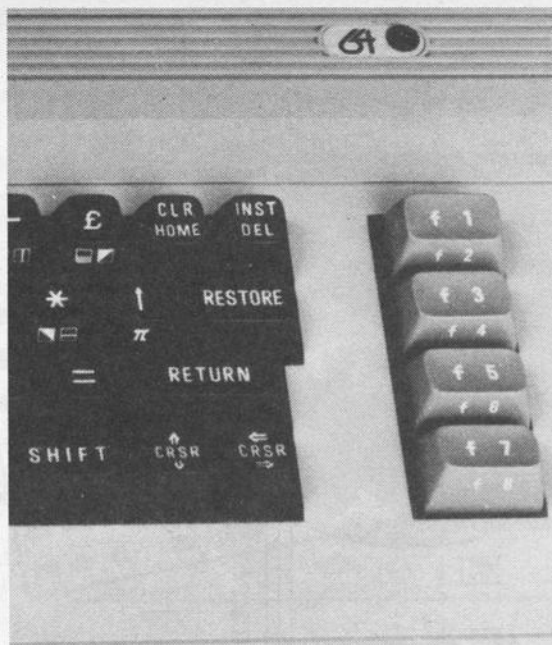

it is the most versatile. The X and Y registers are less clever and are generally used as counters and for temporary storage. Next time I'll discuss the

other addressing modes and we'll wade further into the water. For those of you with the time, try these exercises:

- 1). Write a BASIC analogue to the following routine:  

```
LDA # $0F
LDX # 4
TAY
STY 53280
STA $D021
STX 646
RTS
```

(Note BASIC uses only decimal so you'll have to convert the hexadecimal values).

- 1). b). What does the routine do?
- 2). Write a BASIC analogue and convert it to source code to change the screen green and put a blue Z at the top right corner of the screen.

**Programs** are always supplied on cassette and are accompanied by full details of the program variables, how the program works and any hints on conversion you can offer. Please type these details double spaced. Listings are helpful but not essential. What is vital is that the programs should be completely error free, so please double check.

**Always** use a coupon firmly fixed to the back of your envelope, and fully complete and enclose the cassette inlay card.

We are particularly interested in programs with less than 100 actual lines of BASIC. All submissions are acknowledged.

## Send your programs to HCW!

Use this cassette inlay card for your program

Name \_\_\_\_\_

Address \_\_\_\_\_

\_\_\_\_\_

\_\_\_\_\_

Expansion needed \_\_\_\_\_

\_\_\_\_\_

Special loading instructions \_\_\_\_\_

\_\_\_\_\_

Program title \_\_\_\_\_

Machine \_\_\_\_\_

**COMPUTING** \_\_\_\_\_

Program submission \_\_\_\_\_

---

Complete this coupon and stick it firmly on the back of your envelope

Name \_\_\_\_\_

Address \_\_\_\_\_

\_\_\_\_\_

Program title \_\_\_\_\_ Machine \_\_\_\_\_

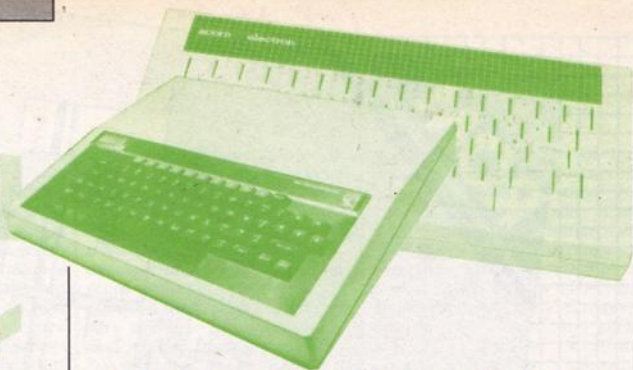

**Jon Revis casts his eye over the Acorn Graphics Extension ROM and reckons it's a top drawer graphic aid for the BBC and Electron**

### Acorn Graphics Extension ROM

Many moons ago when the BBC was still wet behind the ears its creators, Acorn, promised that one day the machines disciples would be freed from the constraints of drawing everything using triangles and lines. Well brothers that day has come, Acorn have just released the official Graphics Extension ROM (GXR).

The 16K ROM fits into any spare sideways ROM socket in the BBC or cartridge slot on the Electron. Depending upon the priority of the socket in which the ROM is placed it will be either active or inactive when the machine is switched on. I would suggest that the user sites the ROM so that it defaults to its inactive status upon power up or when Ctrl/Break is pressed. I make this suggestion because the ROM devours three pages of memory when activated.

This would obviously interfere with any commercial software that you wished to run. It also means that should you have a disc interface fitted and wish to write a program which uses Mode 2 then you are left with a whole 5K of memory into which you must squeeze your program. These memory limitations will not worry users of second processors and even Aries B20 memory expansion boards, as the GXR works perfectly with both of these devices.

The graphics extension ROM is activated using the command \*GXR, following which the user is prompted to press the Break key. The ROM can be disabled again using the command #NOGXR or pressing Ctrl/Break.

One routine which I shall

mention later performs a flood fill function. However this routine alone requires two of the three pages of memory claimed by the ROM. Should you decide that you won't be using the flood fill facility in your program then these two pages can be reclaimed using the command \*NOFLOOD.

The ROM's facilities can be divided into two distinct sections, firstly there are the general purpose routines, circles, squares etc. The rest of the ROM is dedicated to the definition and animation of sprites.

The majority of the new facilities are accessed via the PLOT statement. The manual lists all of the new PLOT numbers, these provide a whole variety of new graphics routines for the BBC. These include rectangles, parallelograms, circles and ellipses, all of which can be filled instantly.

The example cassette which accompanies the ROM provides programs which utilise each of the new PLOT statements. One little point which I found irritating was the fact that all of the new PLOT numbers were given in hexadecimal format when used in the demo programs. Why not stick to good old decimal as they did in the user guide.

The PLOT statement is not the only statement which has been extended by the ROM. The VDU23 and GCOL statements can now be combined to produce a multitude of textured patterns. These are combinations of several colours which are laid out in different ways to give the textured effect. As the definition of these patterns may prove a little complicated for many users a pattern editor program is also provided on the demo cassette.

The flood fill routine is used to fill irregular shapes, it is impressively fast. Its two main forms are to fill an area of background colour until encountering any foreground colour, and to fill over any colour until encountering the present foreground colour.

One very dinky little routine will move or copy an area of screen memory to a new location on the screen. If the move option is in use the area of memory being moved is replaced by the current background colour. In this way the user can animate very large objects with the minimum of fuss. The Acorn example program moves a large cloud around the screen.

The ROM also contains numerous commands which allow the creation, editing, and plotting of sprites. Having reserved some more of your rapidly disappearing memory for storing the sprite definitions you can issue the \*SEEDIT n command and create multi-coloured sprites of different sizes using the in-built editor. These sprite definitions can be saved to disc or tape ready to be used in your own programs. To print a sprite it must first be selected using either the \*SCHOOSSE n command or yet another variant of the VDU23 statement. Finally the sprite is printed on the screen via the PLOT statement. The standard of animation achieved using these techniques is far superior to that produced by Basic alone.

The graphics extension ROM is a very competent piece of firmware which greatly enhances the already excellent graphic capabilities of the BBC. The only snag with this type of ROM is the fact that any programs written using the GXR commands can only be run on a machine which is also fitted with the GXR. **JR**

**Price:** £29.90

**Publisher:** Acornsoft Ltd

**Address:** Cambridge Technopark, 645 Newmarket Road, Cambridge, CB5 8PD



## FIRMWARE

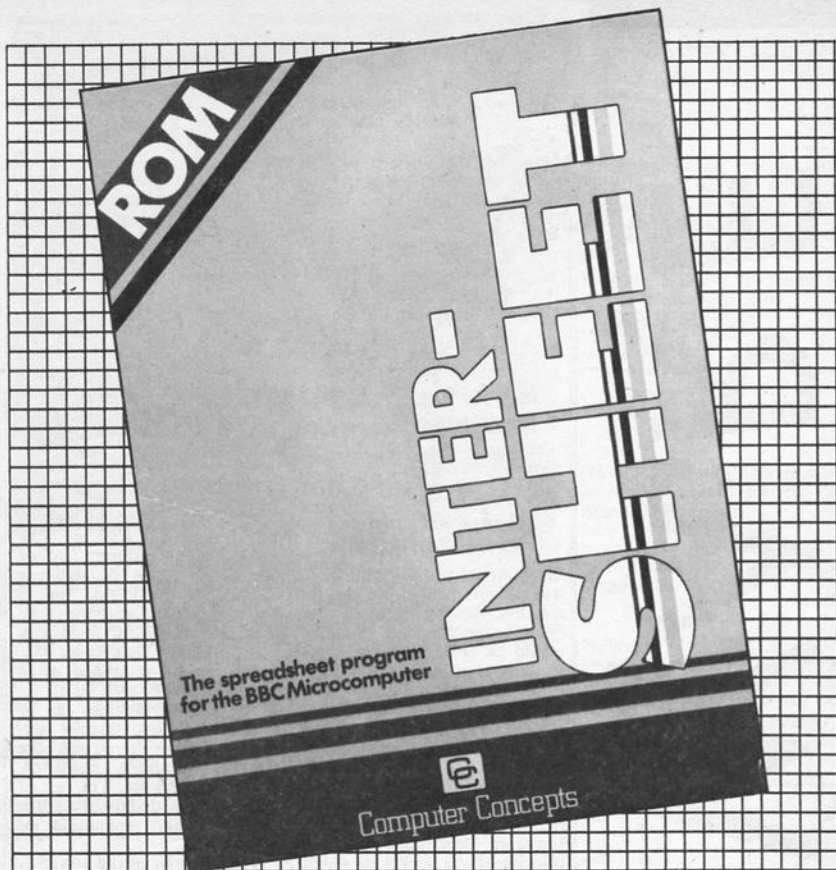

**Spreadsheets are programs which can turn your micro into a powerful number crunching machine. Inter-Sheet gets a thorough going over in this review by mathematician Bill Riding and Richard Seeley**

There is no lack of spreadsheet programs for the BBC machine. They claim to have all the facilities that a home user can want but none have made a name for themselves, in the same way that Wordwise has in the word processor market.

The obvious question to ask therefore is "Does Intersheet really have the facilities or is this, yet another, half useful product with serious limitations?" If sheer packaging is anything to go by then there is a great deal to be said for the product. Your, two tone, blue box contains not just one chip but two and also two manuals. Added to this little lot is a folded reference card and a sheet of amendments.

The basic concept is that Intersheet is the first of a whole range of truly integrated utility

programs which can share files in a simple and easy way. The "second" ROM contains the routines needed to allow this integration but, as this is the first of the series to be released, there is little chance to try the "ROM link" facilities and we will therefore keep this review to the actual sheet facilities and not try to include the linking routines, which will be better covered in a later review of further products.

The first difference between this sheet and a number of its competitors is sheer size. You can have up to 64 columns of 255 rows, a total of over 16,000 boxes, often called cells by other programs. You cannot see all of these at one time, of course, you would need glasses for that. You do have the chance to choose the degree of

eye strain to suffer, with 40, 80 and 105 character options. This means that at best you see 14 columns of 27 rows, quite a large window.

One little niggle is that the headings at the top of the columns are all right justified which can throw the eye a little. This is not such a problem in the higher resolution modes however as the column currently selected is highlighted by appearing in reverse video.

The default setting for each box is 7 characters but the columns can be expanded from 3 to 31 characters individually, a real boon and a major step forward in our view. What is more, you don't need to set the column size before you enter the data — by using the slash ("/") W command you can alter the size of a box during the entry of data. Further slash commands allow you to change the number format, justification and locking of boxes on an individual box, row, column or area basis.

One of these commands requires a fuller explanation. The copy command is accessed by the use of slash C. You can



copy on a box to box, box to area and area to area basis. What is even better is that the formulae have their references changed automatically so that they relate to the new locations correctly without any manual input from you. This is without any doubt the most capable replication facility that we have ever come across and allows you to do the really boring bits very quickly indeed.

The function keys are also used a great deal and to good effect. You can insert or delete a column or row, toggle the editing mode, toggle auto/manual recalculation, and toggle the cursor auto-step with a single key stroke. The edit mode deserves a word or two. If you have entered a complex formula or a long label and then discover a slight mistake it is a real labour retyping the whole of the box again. With this facility all is not lost and you can recover your data in no time at all.

As you will have guessed by now, all the mathematical functions that the user is likely to need are available in this sheet. There are even special, macro, functions such as sum, average, maximum and minimum available. The LOOKUP command is almost unique and very useful — it allows you to find a price from an unknown box by searching the numbers in another list reference. There is also a special form of the IF/THEN/ELSE construction which allows you to abbreviate it to IF (condition, 1st result, 2nd result).

If it sounds good so far, don't give up just yet, there is even better to come...

All sheets have a LOAD and SAVE facility and this one is no exception, but there are two extra facilities which we have been looking for in other products in vain. This sheet has commands which allow the EXPORT and IMPORT of a sheet or a part of a sheet. If

you export the results or the contents of a specified area you can then IMPORT these to another worksheet later. This means that both formulae and data can be stored separately so that they can be re-combined later or used in new sheets in a different way. You can save one part of a sheet and then IMPORT another without disturbing the parts already functioning. This has to be an exciting innovation and is part of the ROM link concept.

When you add onto this marvelous facility the PRINT WORKSHEET and LIST FORMULAE functions you have a very powerful set of storage commands but there are more. You can SPOOL a sheet — giving you output which can then be used in a word processor such as Wordwise or View. The output of this command is ASCII without any control codes which is ideal for further manipulation in the processor.

Finally, there are the ROM link commands proper which allow you to have 16 sheets in memory at one time and to have fully integrated packages — but hand on we said we'd cover all that in a later article.

If you use numbers a great deal, whether to keep the score at cricket, balance the family budget or to make enough money on the stock exchange to buy another BBC machine, then Inter-Sheet is for you and there is no better product as far as we are concerned.

Price: £56.35

Publisher: Computer Concepts

Address: Gaddesden Place, Hemel Hempstead, Herts HP2 6EX

BBC



THE  
THE  
COPPER

IS NOW A  
WHOPPER!

C64/C128  
CASSETTE £8.95  
DISKETTE £12.95  
in your shops NOW, or  
available POST FREE  
FROM

ENGLISH SOFTWARE  
Parsonage Gardens,  
1 North Parade, Manchester M60 1BX. Tel: 061-835 1358

ENGLISH SOFTWARE™  
ENGLISH SOFTWARE™

For help with Reading and Writing

01-405 4017



Since 1975, 350,000  
adults have been helped  
to read and write better.  
If you want help look for  
this sign.

For further information  
Adult Literacy & Basic Skills Unit  
PO Box 213 London WC1V 7ET

If an advertisement  
is wrong we're here  
to put it right.

If you see an advertisement in the press, in print,  
on posters or in the cinema which you find  
unacceptable, write to us at the address below.

The Advertising Standards Authority. ✓

ASA Ltd, Dept 3 Brook House, Torrington Place, London WC1E 7HN

# HOME COMPUTING WEEKLY CLASSIFIED

Lineage:  
35p per word



01-437 0699  
EXT 322.

Semi display: £7.10 per single column centimetre  
Ring for information on series bookings discounts.

Send your requirements to:  
**David Horne**  
**ASP LTD.**  
1 Golden Square,  
London W1R 3AB

All advertisements in this section must be prepaid.  
Advertisements are accepted subject to the terms and conditions printed on the advertisement rate card (available on request).

## Clubs

**AMSTRAD/ATMOS/ORIC 1 CLUB.** Large selection of software available. Send SAE to 26 Beechley Drive, Cardiff.

## Duplication

### CASSETTE DUPLICATION

A high quality service for small software houses. 20-1000 copies in real time onto Chrome with care.  
Ring Beconsfield (04946) 5900.  
SOUNDS GOOD

## For Hire

### Hire & Exchange Software.

Exchange your software! Phone or send list of your software and ask for details. Software hire! No membership charge. P&P free. Hire tapes from £1.50. Phone for details.  
T & P Software, 4 Maine Road, Newland, Drax, Selby, North Yorks.  
Tel: 0757 618007.

### ORIC, ATMOS, COMMODORE 64, LYNX SOFTWARE LIBRARY

Over 150 Oric and 200 Commodore 64 titles.  
Stamp for details.  
Les Wilson 100 Blenheim Walk, Corby, Northants.

### COMMODORE C16 CASSETTE HIRE

AT LAST! ALL THE TOP GAMES AVAILABLE FOR THE C16 CAN NOW BE HIRED FROM  
**DABSOFT**  
LIBRARY CONSTANTLY UPDATED AS NEW GAMES BECOME AVAILABLE. MEMBERSHIP FEE OF £6.50 INCLUDES 2 FREE RENTALS! ONE PRICE FOR ANY GAME. CHARGE OF £1.25 INC P&P BOTH WAYS. FOR COMPLETE MEMBERSHIP KIT POST CHEQUE OR POSTAL ORDER TO  
**DABSOFT (HCW)**  
39 GUILDFORD ROAD,  
LEVENSHULME M19 3FG  
01-445 4375 061-445 4375

To hire a computer and/or peripherals by the week or month, please ring 01 607 0157 or 01 977 6457. We specialise in BBC and Amstrad computers. Computer Hire Services 294d Caledonian Rd, London N1 1BA.

The contents of this publication, including all articles, plans, drawings and programs and all copyright and all other intellectual property rights therein belong to Argus Specialist Publications Ltd. All rights conferred by the Law of Copyright and other intellectual property rights and by virtue of international copyright conventions are specifically reserved to Argus Specialist Publications Ltd and any reproduction requires the prior written consent of the company.  
© 1985 Argus Specialist Publications Ltd

SSN0264-4991

## For Sale

For Sale. Tandy Model II (integral 8" disc drive) and Tandy II Line-printer (15" carriage) with Cobol, Visicalc and Scriptit W.P. for £350.00. Apple II + with disc drive and monitor £200.00. Tandy Model I, 32K interface and two disc drives and monitor, £200.00.

### CLASSIFIED ADVERTISING TERMS & CONDITIONS

Our terms for new advertisers (semi-display and lineage) are strictly pro-forma payments until satisfactory reference can be taken up (excluding recognised advertising agencies). Cheques and PO's should be crossed and made payable to:  
**ARGUS SPECIALIST PUBLICATIONS LTD.**

and send together with the advertisement to:  
**THE CLASSIFIED DEPT., L/H, NO: 1 GOLDEN SQUARE, LONDON, W1R 3AB.**

There are no reimbursements for cancellations. Advertisements arriving too late for a particular issue will be inserted in the following issue unless accompanied by instructions to the contrary.

All advertising sales are subject to Government regulations concerning VAT. Advertisers are responsible for complying with the various legal requirements in force eg: The Trade Description Act, Sex Discrimination Act & The Business Advertisements (Disclosure) Order 1977.

**FULL TERMS & CONDITIONS OF ADVERTISING AVAILABLE ON REQUEST.**

## General

Retailer in Finland. I have bought software books and hardware for the following computers: Spectrum, QL, C64, C16, C128, Amstrad, Atari, Oric, Dragon, MSX, Sharp and memotech. Please put me on your mailing list.  
**TEEMU HOKKANEN, Toukolantie 4-6 76850 Naarjarvi, Finland.**

## Libraries

**BBC B/Electron/Dragon** software library — Membership £5.00. — Tapes 1 (+30p P&P). Stamp for details. E. Tucker, (H) 58, Blenheim Walk, Corby, Northants.

**THE CHART PROGRAM (BBC B)** more details from J..HUGHES 42 CYPRUS ST. BETHNAL GREEN LONDON E2 ONN..

## Software

### WD Software

#### For the QL:—

#### WD Utilities (3rd ed) (base £5.50)

Print 60-file Directory or view it on one screen, one-key LOAD, COPY or PRINT 60 files with one key (allows for namesakes). Multiple FORMATTing to prevent corruption by stretching of tape. TOOLkit to give dated, numbered modules in program development. PRUNE old files to release space (one key DELETES a file). Full instructions in QUILL file. Use up to 6 EXTRA MICRODRIVES (add on your Spectrum ones!)

#### WD Utilities for CST Q-Discs (base £8)

100-file capacity, for CST/Comatamate disc system AND up to 4 extra microdrives. User-friendly timesavers.

#### RefQL (3rd ed) (base £3)

500 useful QL references in an ARCHIVE file (too long for one cartridge with Utilities and Morse).

#### For the Spectrum/QL/BBC

#### WD Morse Tutor (base £4)

From absolute beginner to beyond RYA and Amateur Radio receiving. Adjust pitch. Set speed to your test level (4-18 wpm). Learn from single characters, via groups with wide spaces to random sentences; decrease spacing to normal. Write down what you hear, then CHECK on Screen or Printer (or speech) for Spectrum with Currah MicroSpeech). Also own message, random figures, letters or mixed.

#### For Spectrum 48K

#### Tradewind (base £4)

Sailing/trading strategy game with graphic surprises.

#### Jersey Quest (base £4)

Text adventure with Bergerac and the Dragon (not disc).

#### PRICES (incl Europe postage — elsewhere add £1)

Spectrum/BBC cassettes — base price only  
QL or Spectrum Microdrives — £2.00/cartridge plus base price  
5¼" Floppies, £2; 3¼" Floppies, £5 (please state format wanted).  
Two or more programs on one medium — pay medium + base. e.g. WD Utilities and RefQL for £10.50, but IMPOSSIBLE to mix QL/BBC/Spectrum programs on one medium. Send YOUR cartridge and pay base price but FORMATTed it FIRST in your DRIVE 1 compatibility.  
**WD Software, Hilltop, St Mary, Jersey. Tel (0634) 81392**

### People's Software

10 Lawrence Rd, London SE25 5AA  
3 packages for BBC Micro with disc drive:  
DATABASE, WORDPROCESSOR,  
SPREADSHEET £5 each  
Before ordering send SAE for details

### CBM64 & TI-99/4A:

Soccer Supremo, Soccer management game (HCW \*\*\*\*\*); Pirate Island, board game simulation (HCW \*\*\*\*\*); TI Cricket, limited overs test match (HCW \*\*\*\*\*).  
£4.99 each, 2 for £8.99 or 3 for £12.50 from:  
Dromeda Software, 56 Wells Street, Haslingden, Lancashire BB4 5LS

**ONE DAY ALL THIS SPACE COULD BE YOURS PHONE DAVE 01 437 0699 ex322**

## CP/M Software

**"FREE" CP/M SOFTWARE** for Amstrad, Tatung, BBC (second proc) etc, Free Software handbook plus 70 programs on disc for as little as £27.95.  
Ring 0386 84181. Access/Visa.  
DAVIS RUBIN ASSOCIATES,  
1 CANONBOURNE,  
WESTON SUBEDGE, GLOS GL55 6QH

# CLASSIFIED RING 01-437 0699

## Repairs 'n' Spares Register

### CHILTERN COMPUTER CENTRE

Fast reliable service

Spectrum £18 incl.

We also repair BBC, Commodore, Oric, Dragon disc drives and printers.

Ring 0582 455684 for details.

Send computer with details incl cheque to:  
Newcorn Computers Ltd (HCW),  
76B Dallow Road,  
Luton, Beds

### SPECTRUM REPAIRS

£16.85 inc Labour, parts, P&P.

Fast, reliable service by qualified Eng's. Average repairs 24 hrs, 3 months guarantee. For help/advice ring:

H.S. Computer Services, Unit 2, The Orchard, Warton, Preston, Lancs PR4 1BE. Tel: (0772) 632686

### Computer Repairs in Hampshire

Spectrum £19.95 inc VAT, p&p.

BBC, CBM 64 from £19.95.

Also Atari and VIC-20.

### COMPUTER CARE SOUTH

149 KINGSTON ROAD,

PORTSMOUTH,

HAMPSHIRE

Tel: 0705 825110

### COMPUTER REPAIRS

We are the experts, having serviced Sinclair computers since the introduction of the ZX80.

Don't waste money on estimates - we repair Sinclair computers at price quoted (inclusive parts, labour, postage, VAT, irrespective of fault. No hidden charges. Repairs guaranteed for 3 months.

Spectrum	£18.75 inc parts
ZX81	£11.50 inc parts
16 KRam	£9.95 inc parts
Microdrive	£15.95 inc parts
Interface 1-11	£18.75 inc parts
	also
BBC	£22.00 + parts
Electron	£19.95 + parts
XX Memory Expansion Kit	£15.95

Computer Retailers please phone for Special Trade Price.

Call or send with cheque or P.O.

T.V. Services of Cambridge Ltd.

French's Road, Cambridge, CB4 3NP

Tel: 0223 311371

### COMPUTER REPAIRS IN SOUTHEAST

Spectrum/Plus	£19.95
Spectrum K/B faults	£12.95
Interface 1/2	£14.95
New Spectrum power supply	£9.95
C64/Vic 20	from £12.95

Above prices include parts, post & packing.

All repairs are guaranteed 3 months.

Call in or phone for more details.

### MINNIE MICRO ELECTRONICS

12 EASTERN ESPLANADE,

SOUTHEAST, ESSEX.

Tel: (0702) 62033/615809

OPEN 7 DAYS A WEEK

## CLASSIFIED ADVERTISEMENT — ORDER FORM

1	2	3
4	5	6
7	8	9
10	11	12
13	14	15

Please place my advert in Home Computing Weekly for \_\_\_\_\_ weeks. Please indicate number of insertions required.

Would advertisers also add 15% VAT

ONLY 35p per word (minimum charge 15 words)

CLASSIFIED DEPT., HOME COMPUTING WEEKLY,

1 Golden Square, London W1R 3AB

Tel: 01-437 0699

Name .....

Address .....

.....

.....

.....

.....

.....

.....

.....

.....

.....

.....

.....

.....

.....

.....

.....

.....

.....

.....

.....

.....

.....

.....

.....

.....

.....

.....

.....

.....

.....

.....

.....

.....

.....

.....

.....

.....

.....

.....

.....

.....

.....

.....

.....

.....

.....

Scot Press Ltd, publishers of Popular Computing Weekly, is pleased to announce that it has purchased Home Computing Weekly from Argus Specialist Publications Ltd.

From next week's issue HCW's most popular features will be incorporated into Popular Computing Weekly.

"We are very pleased to have reached this agreement with Argus. Popular Computing Weekly is now secure in its position as the only weekly magazine serving the consumer computer market", says Duncan Scot, Managing Director of Scot Press Ltd.

Popular Computing Weekly was launched in April 1982 and has maintained its position as market leader since that date. Personal Computer News (by VNU) and Home Computing Weekly (by Argus) were launched in March 1983. Personal Computing News was closed last Spring. Popular Computing Weekly is now left with a solus position in this market.

The Editor and staff of HCW would like to thank their readers, advertisers and the retail news trade for their support and trust this will continue under the magazine's new ownership.



# VENTURES

I didn't watch much of the recent Robin Of Sherwood television series, but from what I did see it was pretty good, far removed from the daft fifties version. The emphasis had moved from "riding through the glen with his merry men" and silly hats (younger readers won't understand a word of that — my mum told me!) to a faithful reconstruction with strong elements of magic and the supernatural. It did very well in the ratings too.

Adventure International bought the rights, and handed the idea to Mike Woodroffe, Brian Howarth and Teoman Irmak, who produced the top-selling and witty Gremlins game. They obviously expect a similar hit with Robin based on its good credentials. I'm sad to say it does not deserve to be.

But, before the criticism, the scenario. Back in the twelfth century, a horned god called Herne summoned the Hooded Man to the forest. This man — Robin, played by you — must lead the resistance against the Normans, particularly Robert de Rainault, the evil High Sheriff of Nottingham. In this particular game your task is to find the six touchstones of Rhiannon and return them to their rightful home.

You start in a dungeon, which made me feel quite at home! As usual, the text is best described as 'informative': "You are in a dark dungeon. You see: Much, Will Scarlet. Locked Grating. Prisoners." It was no better in Gremlins of course, but with that game there were the excellent animated graphics to look at. Sadly, in Robin they are not so impressive; with the exception of a waterfall there is no animation, and most other characters in the game, like Friar Tuck and Little John, are not depicted. In The Hobbit this was acceptable — in a book people use their imagination — but as this is based on a TV programme the actors' faces could be used. The locations are very moody though, and colour is superbly used.

I have several major niggles. Vocabulary is as poor as ever, and the responses are rather cardboard-like, although at least you can talk to people. Sometimes the game is too fussy — at the start, you need to use STRANGLE which is a bit obscure; and at the other extreme,

## ROBIN OF SHERWOOD

The Touchstones of Rhiannon



© 1984 H.T.V. Ltd. Goldcrest Films and T.V. Inc based on the series by Richard Carpenter.

An Adventure by  
Mike Woodroffe and  
Brian Howarth

SPECTRUM 48K  
WITH GRAPHICS  
Cassette £9.95

**Look out for the arrows as our  
dungeon dweller Peter Sweasey meets  
Robin Hood and still finds room for a  
few reader's problems**

the program thinks GIVE is the same as DROP. GET ALL is not understood, although it was in Gremlins. If you type a command the computer doesn't understand, instead of printing a suitable response it is often totally ignored, which isn't very helpful. In some locations there are two unnamed doors, you being required to GO LEFT or RIGHT DOOR. Why not east or west? And so on.

Sherwood Forest is vaguely maze like in that it has no edges and all looks the same. Many buyers of this game will probably be the same occasional adventurers who sent Gremlins into the Top Ten, and I don't think they will like this large, repetitive area. It takes up a lot of the game and is easy to get lost in.

Another really annoying feature: you have to stop the tape at one point when loading to read some silly credits. This means sitting around watching it load instead of making some tea. And the instructions are still unclear; they call it a Scott

Adams game and tell you to try HELP even though it is not understood.

My main criticism is that the game has no atmosphere. Whereas Gremlins caught the anarchic feel of the film exactly, this feels empty and in no way mystic or exciting. The brief text and restrictive vocabulary put an instant damper on any interesting fights or complex problems yet the game needs such features.

The occasional adventurer will not find enough instant appeal in the game, and adventure buffs will find it too limited. It won't appeal much to Robin Of Sherwood fans either; no Clannad theme tune or Michael Praed (much to the disappointment of Gorand, my elfin assistant, although a "full colour poster" offer is mentioned). Because it's a TV tie-in I expect it will go into the Top Twenty, even though better adventures are available for less than this, rather inflated, price. It's not a particularly bad game, but it's not very good either.

My rating would be lower but for the graphics. So, unless you want pretty pictures, not recommended.

A quick mention for a product called Map Maker I was sent recently. It is basically a white plastic sheet with boxes printed on it. Using a special pen you can map out an adventure, then when you have finished, wipe the ink off with a damp cloth and re-use. I can see two disadvantages: it's no good if you play more than one game at a time, and it only has 143 boxes, so large games like Red Moon cannot be mapped easily. It seems rather pricey for what it is, but if you like the sound of it, it works fairly well.

### Robin of Sherwood

Price: £9.95 graphics  
£7.95 text only

Publisher: Adventure International

Address: 85 New Summer Street, Birmingham B19 3TE

Machine: CBM64, Amstrad, Spectrum, BBC



### Map Maker

Price: £4.49

Publisher: Mapit

Address: 166 Robert Street, Ynysybwl, Mid Glamorgan.

Machine: All



### Helpline

First up some hints for those lucky people who own Runestone. There seems to be some difficulty in obtaining it at the moment, but I expect the Firebird version will hit the shops soon. Orcs will capture Eliador and Greymarel quite quickly, so use them first. You'll need help from Chrona, Brunor, Eldric and Questor. As Morval guide this lot to a dragonship. In the Island with the tower in the Great Waters is the Book of Zaramir. Give this to Chrona, and ask her to read



### Plea from the dungeon

The helpline is short this time because I haven't received many letters recently. Write to me! I have been writing Ventures for almost a year now, so what are your opinions? Do you like it as it is, or would you like some alterations? I'm always happy to print your name if you've just completed an adventure — and I'd like to see your solutions. Plus of course, if you have a problem with an adventure, I can help. I give a personal reply as quickly as possible, and you might see your name in print too! Here are some of the games Ventures can help with: Colossal Adventure, All Level 9 games

(including Eric the Viking), all Scott Adams, Gremlins, Robin Of Sherwood, all Artie games, The Hobbit, Witch's Cauldron, Wrath of Magra, Colditz, Valkyrie 17, Runestone, The Ket Trilogy, all Interceptor, Knight's Quest, Tir Na Nog, Twin Kingdom Valley, Hampstead, MikroGen adventures and many more. So go on — put pen to paper. And happy venturing!

Write to: Ventures, Home Computing Weekly, No. 1 Golden Square, London W1R 3AB.  
Don't forget your name and address!

it until she repeats herself. These are the magic words for Greymarel — write them down. Take the book to him and he'll be able to cast spells. If he's been captured, go to him where he is imprisoned, usually Kildroth's tower in the Bay of Towers. Now you can have a good, long fight! Morval can fight of course, Eliador can use his arrow, and Brunor will fight if you ask him to. I won't tell you all Greymarel's spells, but CAST SHAZAROTH AT (whoever) will send the person or orc to the Island in the Great Waters. Could be useful . . .

Regular readers will know I am a great Valkyrie 17 fan, although I have been stumped for ages. Londoner Freddie Still points out to me what I have been overlooking: GET

MIRROR in the corridor outside room 17. Another picture clue! The bubbles are a red herring — but the aqualung is needed later. To go somewhere in the taxi, type SCHLOSS. Meanwhile, Colin Shovelloy from Bracknell is unable to buy the girl a drink earlier in the game. You need to PAWN NECKLACE at the pawnbrokers then take the money to the hotel, PAY BILL, and buy her one with the change. The sequel to V17, Three Days In Carpathia, is due out at the end of September. Review soon!

Nigel Vincent from Whitby in Yorkshire cannot get the map in Incentive's Mountains of Ket. Ventures regular John Wilson of Rochdale has the answer. Go to the store and buy the axe, then go south three times. Chop

the log, take it to the cartographer and he will give you seven coins and the map.

Marie Hills writes from Suffolk about Gremlins. She needs to cause an implosion. Try TURN OFF VALVE of bottle, CUT PIPE with hacksaw, when the plastic pipe isn't present, JOIN PLASTIC PIPE with tape then INSERT PIPE into the hole in the plate in the hardware department. Stripe will want a swim! (What is this? A bomb making kit? Ed.)

Pete Smith from Milton Keynes cannot find Electro and Doctor Octopus in Spiderman. You need to stop the fan by SHOOTING your WEB at it, then GO FAN. Head down through the vents and you'll find them!

**Humming along with Hypersports**

This is a musical tip for Hypersports on the C64 from Sean O'Kane of Derry, N. Ireland.

"When the first tune begins stop the tape recorder and don't start it again. The tune continues as normal but when it comes to the end, it starts again only this time some of the channels have changed and you get a "remix" of the original tune."



"You carry what you want . . ."

**Help!**

I am a Spectrum owner and as I am starting to program in machine code, I made this small routine to print text from machine code itself. It works to a certain point. It prints the text in quotes alright but after that, even though there is nothing else to print it goes on printing the following words; LLIST # # RESTORE RETURN.

I tried modifying it but to no avail — it still printed those extra words. My question is what is wrong with the program and how can I rectify the bugs?

Here is the routine (I used HI-SOFT GEN3M1 assembler):

```
CALL PRT
DEFM "THIS IS A
TRY", # FF
PRT POP HL
LD A,(HL)
INC HL
PUSH HL
CP # FF
RET Z
RST 16
JR PRT
```

Guillaume Thibaudau, London W8

**Readers Hi-score table**

Name	Game	Machine	Score
Richard Burton	Decathlon	Amstrad	654,770
	Roland In Time	Amstrad	124 Crystals
	Technician Ted	Amstrad	21 tasks
Simon Wilson	Hypersports	Spectrum	265,902
Mick Coles	Blogger	C16	63,750
	Tower of Evil	C16	578,530
	Skramble	C16	118,480
	Big Mac	C64	116,887
Tobias Peberdy	Munchmania	C64	96,650
	Action Biker	C64	242,600
	Road Over Moscow	C64	346,600
Andrew Clarke	Beach Head	C64	358,800
	Bruce Lee	C64	1,055,675

**Eggtraordinary**

Its NME again your intrepid Chuckie Egg explorer reporting from yet another late night session and I am pleased to announce that I've done it. I've beaten Chuckie Egg — well almost. After several hours of hard work I reached level 255 with five geese, 1 duck, several coffee cups and digestive crumbs and 100 on the time.

that I was on level 0 unfortunately still with geese and duck. Worse horrors were to come for the next level was exactly the same as level 1. I continued the game until I reached level 12 where I committed suicide by jumping on the duck since by that time it was nearly 4am. Score — 5176170, eggs collected — 3216.

Then after completing level 255 I discovered to my disgust

Lucy Bird, Newcastle on Tyne

**OFFA LAURIE**  
Discount tapes!



**Bargain Tapes**

If you can buy any number of tapes from your friendly market computer stall, not just those offers shown here, how many would make the best buy?



# Shadow of the UNICORN

**THE FIRST EVER MIKRO-PLUS GAME**

**Nearly 50% bigger and better game for the Spectrum**

Shadow of the Unicorn - a 120 page illustrated book, 64K of programme, and Mikro-Plus interface - all for £14.95

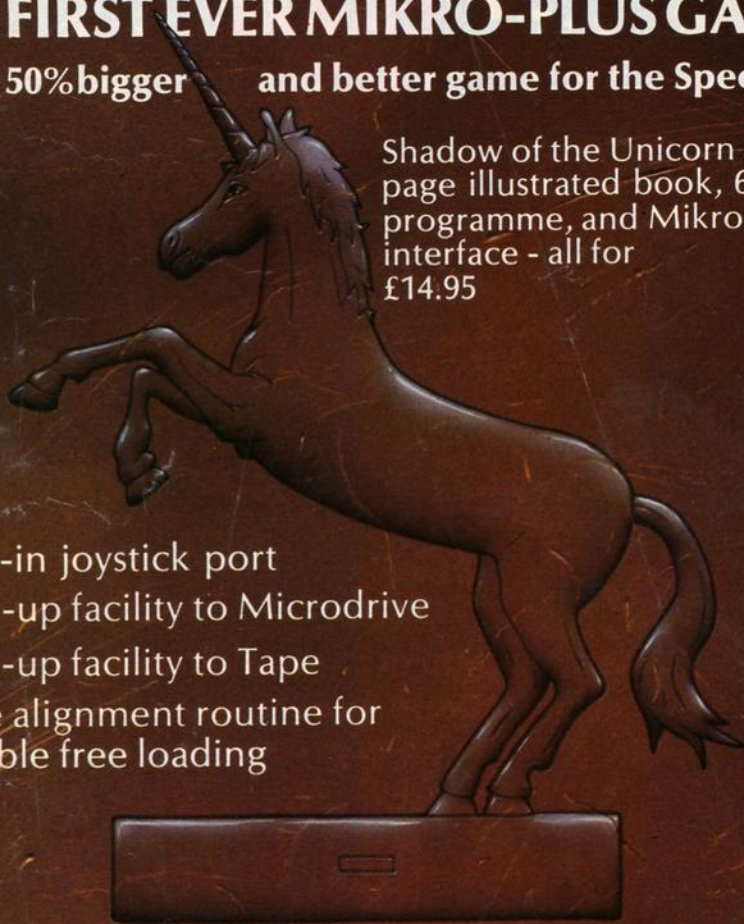

- Built-in joystick port
- Back-up facility to Microdrive
- Back-up facility to Tape
- Tape alignment routine for trouble free loading

# RABBIT'S BACK!

WITH 4 GREAT GAMES TO KEEP YOU ON THE HOP!

ONLY  
**£3.99**  
R. R. P.

BETTER  
THAN  
BUDGET!



## ZYTO

C O M M O D O R E 6 4

- Multi-screen, multi-level action
- Ingenious codes to break, equipment to use
- Colourful scrolling graphics and great sound effects



## DORIATH

C O M M O D O R E 6 4

- Vast scrolling labyrinth to explore
- Superbly arranged title music
- All the magical qualities of an excellent arcade adventure
- Impressive graphics depicting the quest of Elidaan

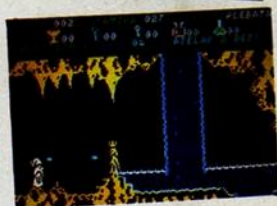

## THE GREAT FIRE OF LONDON

S P E C T R U M 4 8 K

- Game is played on an authentic scrolling map of London (circa 1666)
- Design your own map facility incorporated
- Game save facility
- Success requires fast action and strategy



## HIGH RISE HORROR

B B C M O D E L B

- Fast devious enemies to eliminate
- Superb sound effects
- Top speed responses necessary in this game!



From Virgin Games Ltd., 2-4 Vernon Yard, 119 Portobello Road, London W11 2DX. 01-727 8070.

Chover