

February
1984

AN ARGUS SPECIALIST PUBLICATION



CGAMES COMPUTING

The magazine for those who take their computer and video games seriously ^{80p}

Shoot the space scouts
in this mean
Oric game

Great games to
play on **Oric**,
Atari, BBC,
VIC, Texas,
Spectrum

FREE: Pull-out
POSTER PROGRAM

CRAZEE CONG

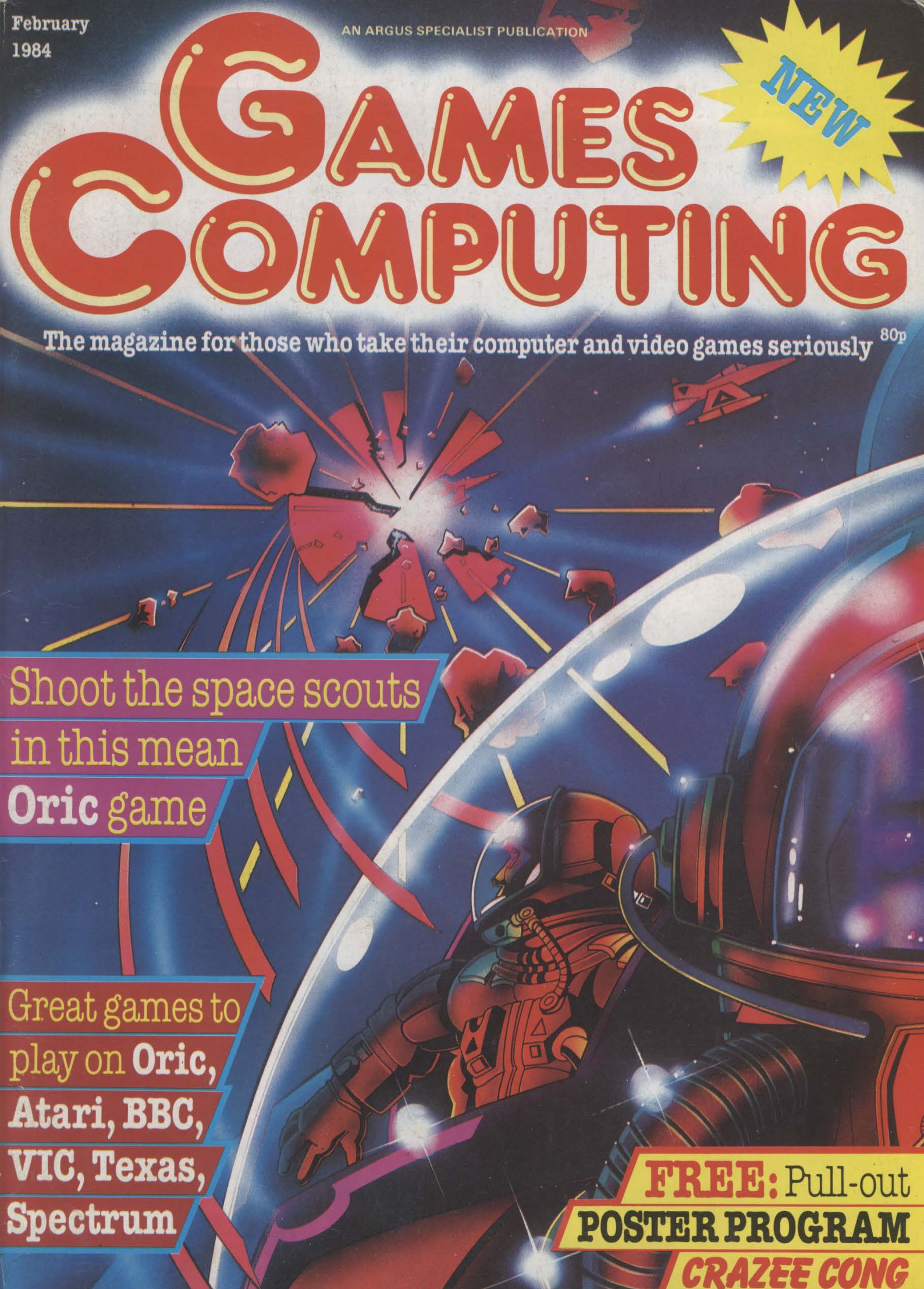

TERMINAL SOFTWARE

commodore 4 games cassettes

SUPER SKRAMBLE!

Personal Computer News (15-21 Sept '83) gave SUPER SKRAMBLE! an overall rating of NINETEEN OUT OF TWENTY and described it as: "Well implemented with beautifully smooth scrolling and very nice graphics."

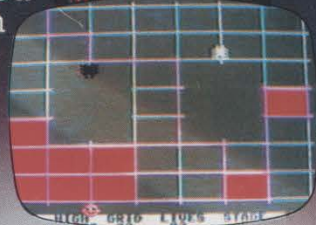

SUPER GRIDDER

"... a compelling piece of frivolity that could give hours of fun." was the verdict of Personal Computer News (22-28 Sept '83).

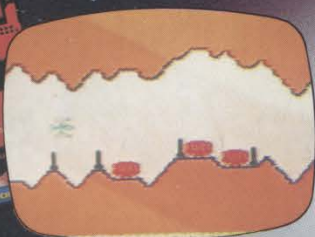

SUPER SKRAMBLE!

"An excellent game" said Computer & Video Games magazine (Sept '83).

TERMINAL

The first 4 games cassette to have **SIMULTANEOUS TWO-PLAYER ACTION** - realistic sound effects too.

STELLAR DODGER

A game of skill and anticipation in which you must dodge your way through asteroids to complete your mission.

NEW



NEW

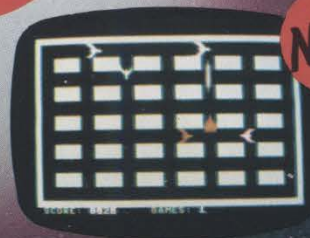

HUNTER

A fast action game in which your pursuers gain in speed and intelligence as you master each successive screen.

sinclair 48k

VAMPIRE VILLAGE and **SPACE ISLAND** are REAL-TIME graphic adventures and every game is different from the one before.

CITY is a unique REAL-TIME better-than-a-board game for 1-4 players that combines simplicity of use with complexity of form as the city you build takes on a life of its own.

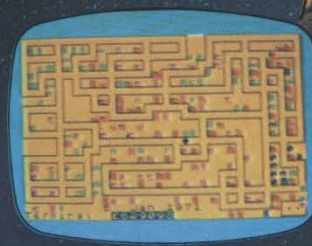
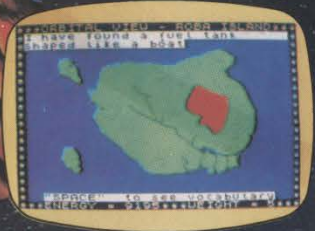

SELECTED PROGRAMS AVAILABLE IN:

Dixons SOFTWARE EXPRESS Greenchip at DEBENHAMS

LAKEYS

TERMINAL SOFTWARE
28 CHURCH LANE, PRESTWICH, MANCHESTER M25 5AJ
TEL 061 773 9313

PRINCIPAL WHOLESALE DISTRIBUTORS:
PCS BLACKBURN, CentreSoft WEST MIDLANDS
SoftShop LONDON

EUROPE:
WICOSOFT - DÜSSELDORF
TIAL - ÄLMHULT
AASHIMA - ROTTERDAM

CONTENTS

Astro Attack6

A game of galactic cunning and skill for all levels of space commanders.

Software News..... 11

What's to come on the software games scene for you to sample.

The Runaway Robot Replies 16

Our resident robot (still to be named by you) has been running riot over letters sent to the magazine. Have you got something to say? Then why not say it to the Runaway Robot. Read on

I've Started So I'll Finish..... 20

A great memory game to test the quickest of minds and find the hidden number.

Simon Says..... 26

Put your hands on your head (with your Atari computer too)!

Towers of Brahma 30

Bend your mind with this game of brain power requiring lots of logistic thought.

Square Solitaire 32

Want something quick and easy to play on your Atom? We've got just the job here.

Software Reviews..... 37

The good, the bad and the ugly of games to play.

Froggy..... 42

Cross the road and dodge the traffic. If you think you're safe try jumping across the river. It's not as easy as you think!

Computer Animation 48

Some great graphics are now used in computer games but there is another dimension which was shown at London's Computer Animation Festival.

FREE PULL OUT POSTER PROGRAM

Craze Cong..... 53

This issue our centre pages give Cong the chance to show off his prowess.

Video Vying 63

Video games for the Colecovision reviewed and some snippets of news from the world of video gaming.

Wumpus Hunt..... 66

Play this thrilling and daunting adventure game for the 48K Oric. It'll drive you wild with frustration that will keep you coming back for more!

COMPETITION

WIN software and sweatshirts from leading software firm **Arcadia**.

Mind Benders Puzzle Page 77

More puzzles for you to pore over and find out the answers to last months brain teasers..

Alien Dropout 78

Danger looms larger than life on your TV screen when you get switched on to this great game.



ROME to RAM82

Don't miss the second part of this fascinating series all about playing wargames on home micros.

Alien Scouts 84

This month's cover illustration is devoted to this Oric hunt and destroy game — all the fun of arcade games.

Hangman88

Family games for all to enjoy but this age old world will keep everyone quiet for hours.

Card Crazy..... 91

Card sharpening's just as popular today as it was in the saloons of the America's old west. Try your hand at beating the computer.

Spuckman 94

Gobbling ghosts galore plague you in a super Spectrum to play.

Yahtzee 98

That traditional dice game put on to computer for a moment of strategy thinking.

Editor Elspeth Joiner
 Editorial Assistant Jane Price
 Software Assistant Simon Rockman
 Advertisement Manager Sue Jensen
 Assistant Advertisement Manager Julie Bates
 Managing Editor Ron Harris
 Chief Executive T J Connell
 Origination and Design MM Design & Print
 Cover Illustration Paul Desmond
 Editorial/Advertisement Telephone: 01-437 1002

Games Computing is normally published on the second Friday in the month preceeding cover date. The contents of this publication including all articles, designs, plans, drawings and programs and all are all copyright and other intellectual property rights therein belong to Argus Specialist Publications Limited. All rights conferred by the Law of Copyright and other intellectual property rights and by virtue of international copyright conventions are specifically reserved to Argus Specialist Publications Limited and any reproduction requires the prior written consent of the Company. © 1983 Argus Specialist Publications Ltd. All reasonable care is taken in the preparation of the magazine contents, but the publishers cannot be held legally responsible for errors. Where mistakes do occur, a correction will normally be published as soon as possible afterwards. All prices and data contained in advertisements are accepted by us in good faith as correct at time of going to press. Neither the advertisers, nor the publishers can be held responsible, however, for any variation affecting price or availability which may occur after the publication has closed for press.

Subscription rates.

UK £12.25 including postage. Airmail and other rates upon application to Games Computing, Subscriptions Department, 513 London Road, Thornton Heath, Surrey CR4 6AR.

Published by: Argus Specialist Publications Ltd
 145 Charing Cross Road London WC2H 0EE

Printed by: Alabaster Passmore & Sons Ltd, London & Maidstone
 Distributed by: Argus Press Sales & Distributors Ltd 12-18 Paul Street London EC2A 4JS

DSS Discount Software Supplies

8 PORTLAND ROAD, LONDON W11 4LA 01-221 1473

**AMAZING SOFTWARE BARGAINS BY MAIL, 100's OF TITLES AVAILABLE!
TELEPHONE ORDERS WELCOME. WRITE OR RING NOW FOR FULL DETAILS**

SPECTRUM

Name	Supplier	RRP Inc. VAT	Our Price Inc. VAT
Manic Miner	Bug Byte	5.50	4.95
Spectres	Bug Byte	5.95	5.20
Styx	Bug Byte	5.95	5.20
Pool	Bug Byte	5.95	5.20
Aquarius	Bug Byte	5.95	5.20
The Castle	Bug Byte	6.95	5.99
Zip Zap	Imagine	5.50	4.49
Arcadia	Imagine	5.50	4.49
Zzoom	Imagine	5.50	4.49
Schizoids	Imagine	5.50	4.49
AM Diddums	Imagine	5.50	4.49
Jumping Jack	Imagine	5.50	4.49
Molar Maul	Imagine	5.50	4.49
Penetrator	Melbourne House	6.50	5.95
Terror Dackill 4D	Melbourne House	6.95	5.95
Robon	Softek	5.95	4.95
Firebirds	Softek	5.95	4.95
Repulsar	Softek	5.95	4.95
Transylvanian Tower	Richard Shepherd	6.50	5.25
Everest Ascent	Richard Shepherd	6.50	5.25
Super Spy	Richard Shepherd	6.50	5.25
Devils of the Deep	Richard Shepherd	6.50	5.25
Invincible Island	Richard Shepherd	6.50	5.25
Hall of the Things	Crystal	7.50	6.50
Rommels Revenge	Crystal	7.50	6.50
The Dungeon Master	Crystal	7.50	6.50
Invasion of the Body Snatcha's	Crystal	7.50	6.50
Shark Attack	Romik	5.99	4.99
Colour Clash	Romik	7.99	6.99
Spectra Smash	Romik	6.99	5.99
Jet Pac	Ultimate	5.50	4.50
PSST	Ultimate	5.50	4.50
Cookie	Ultimate	5.50	4.50
Tranz AM	Ultimate	5.50	4.50
Atic Atac	Ultimate	5.50	4.50
Lunar Jet Man	Ultimate	5.50	4.50
Astron	DK Tronics	9.95	8.70
Fruit Machine	DK Tronics	4.95	4.49

SPECIAL OFFER FOR SPECTRUM

VALHALLA.....RRP..£14.95

OUR PRICE.....£11.95

DRAGON 32

Texstar	PSS	12.95	11.50
Draw Bug	PSS	12.95	11.50
Flight Simulator	PSS	7.95	6.95
Grand Prix	Salamander	7.95	6.95
Night Flight	Salamander	7.95	6.95
Monsters	Softek	7.99	6.95
Strategic Command	Romik	9.99	8.75

COMMODORE 64

Name	Supplier	RRP Inc VAT	Our Price Inc VAT
Kong 64	Anirog	7.95	6.99
Scramble 64	Anirog	7.95	6.99
Frog Run 64	Anirog	5.95	4.95
3D Time Trek	Anirog	5.95	4.95
Cyclons	Rabbit	5.99	4.99
Centrapods	Rabbit	5.99	4.99
Monopolee	Rabbit	5.99	4.99
Annihilator	Rabbit	5.99	4.99
Pakaluda	Rabbit	5.99	4.99
Panic 64	Interceptor	7.00	5.99
Crazy Kong	Interceptor	6.95	5.95
Star Trek	Interceptor	6.95	5.95
Frogger	Interceptor	6.95	5.95
Sprite Man	Interceptor	6.95	5.95
Attack of Mutant Camels	Llamasoft	7.50	6.50
Matrix	Llamasoft	7.50	6.50

VIC 20

Arcadia	Imagine	5.50	4.75
Wacky Waiters	Imagine	5.50	4.75
Catcha Snatcha	Imagine	5.50	4.75
Frantic	Imagine	5.50	4.75
Cosmiads	Bug Byte	7.00	5.99
Vic Panic	Bug Byte	7.00	5.99
Vic Asteroids	Bug Byte	7.00	5.99
Crazy Kong	Interceptor	6.00	5.25
Jupiter Defender	Interceptor	6.00	5.25
Vic Rescue	Interceptor	6.00	5.25
Animatter Splatter	Rabbit	5.99	4.99
Paratrooper	Rabbit	5.99	4.99
Cyclons	Rabbit	5.99	4.99
Skramble	Rabbit	5.99	4.99

ATARI

Krazy Kopter	English Software	14.95	10.99
Time Warp	English Software	14.95	10.99
Air Strike	English Software	14.95	10.99
The Time Machine	Channel 8	9.95	8.95
Circus	Channel 8	9.95	8.95
The Golden Baton	Channel 8	9.95	8.95

ORIC

Sea Harrier Attack	Durrell	6.95	5.95
Lunar Lander & Asteroids	Durrell	6.95	5.95
Galaxians	Softek	6.95	5.95
Super Meteors	Softek	6.95	5.95
Xenon	IJK	8.50	7.50
Invaders	IJK	7.50	6.50

BBC

The Music Processor	Quicksilva	14.95	13.25
Protector	Quicksilva	7.95	6.95
Wizard	Quicksilva	6.95	5.95
Games Compendium	Salamander	6.95	5.95
Tanks	Salamander	7.95	6.95
Dragon Rider	Salamander	7.95	6.95

INCREDIBLE SPECIAL OFFER!

THE HOBBIT + BOOK FOR THE SPECTRUM

RRP
£14.95

OUR PRICE
£10.95

TO: DISCOUNT SOFTWARE SUPPLIES PLEASE ACCEPT MY ORDER FOR THE FOLLOWING PROGRAMS/SPECIAL OFFERS

1.
2.
3.
4.
5.

Make cheques payable to Discount Software Supplies

Cheque No For £ enclosed

Please debit my Access Card No

Signed

DISCOUNT SOFTWARE SUPPLIES
8 Portland Road, London W11

SEND

Name

Address

DSS IS THE TRADING NAME FOR DOVEPACE LTD

SEND SAE FOR UP TO DATE LIST OF OUR AMAZING BARGAINS



More
WINNING GAMES
 from
LYVERS  **FT**

LUNAR RESCUE (48K SPECTRUM)
 A team of research scientists are trapped on the moon and you have to pilot the rescue pod from the mother ship and ferry them back safely. But you have only space for one scientist at a time. 100% M/C action with super smooth HI-RES GRAPHICS AND JOYSTICK OPTION.

LIBERATOR (16K/48K SPECTRUM)
 This game tests your aim and reactions as you command a gunsight on a homeward bound space freighter. Your cargo is the royal treasures of the empire and many people want them. A machine code presentation that should have you hooked.

THUNDERHAWK (48K SPECTRUM)
 Based on the popular arcade game Phoenix. This 100% full colour epic pitches you against the evil Albertrons who are set to destroy your race, five levels of fast action bring you to the command centre of battle fleet, can you finish the job. WITH JOYSTICK OPTION.

GOLF (48K SPECTRUM)
 Using M/C graphic routines, a game to absorb the keen novice and the scratch player. Play on a 9 or 18 hole course, with full selection of clubs. Along the greens and fairways hours of addictive sport can be had.

PICTURE PUZZLE (DRAGON 32)
 With HI RES graphics and M/C. You are set the problem of putting the picture back together. Test your skill against the dragon 32 computer. A game guaranteed to hold you spell bound for hours.

ANDROID INVADERS (DRAGON 32)
 In a change of tactics the beings beyond the stars have developed an android of human form to do their dirty work. And with the aid of sensor jamming they may prove formidable. Using full colour, M/C, hi-re graphics this game can offer up to 21 levels of combat.

VOYAGER (VIC 20 8 OR 16K)
 The mission is simple, but its completion is far from being so. As captain of starship you have all the best facilities at your disposal. Unfortunately the kingons oppose you. A great M/C version of this classic computer game.

SPHINX (VIC 20 16K)
 A riveting, full colour graphic adventure. That pits you against the spells and guardians of the tomb. In your quest to uncover the treasure of the pharaohs. This game will have you enthralled.

BIRD OF PREY (BASIC VIC 20)
 Evil baron von fritz is out to kill his cousin, the much loved Prince Rupert. The Baron intends to throw the prince from his plane into the sacred fire pit. But you the eagle of the north will make every endeavour to save your friend Prince Rupert. With colour, sound, this M/C game is a must.

ALSO AVAILABLE:

Demon Driver Basic VIC20 — £5.95	Nuclear Attack/Grand Prix Basic VIC20 — £5.95
Lunar Rescue Basic VIC20 — £5.95	Hearts & Diamonds/Hi-Lo Basic VIC20 — £5.95
Apple Bug/Crazy Climber Basic VIC 20 — £5.95	Machine Code Monitor VIC20—£14.95



- LUNAR RESCUE (48K Spectrum) @ £5.95 each
- GOLF (48K Spectrum) @ £5.95 each
- VOYAGER (VIC20 8 or 16K) @ £5.95 each
- LIBERATOR (16K/48K Spectrum) @ £5.95 each
- PICTURE PUZZLE (Dragon 32) @ £5.95 each
- SPHINX (VIC20 8 or 16K) @ £5.95 each
- THUNDERHAWK (48K Spectrum) @ £5.95 each
- ANDROID INVADERS (Dragon 32) @ £5.95 each
- BIRD OF PREY (BASIC VIC20) @ £5.95 each

For any VIC-20

Please debit my Access/Barclaycard (delete as necessary)
 Card
 Number
 I enclose Cheque/PO for £
 Name
 Address
 66 Lime St., Liverpool L1 1JN Tel: 051 708 7100 GC

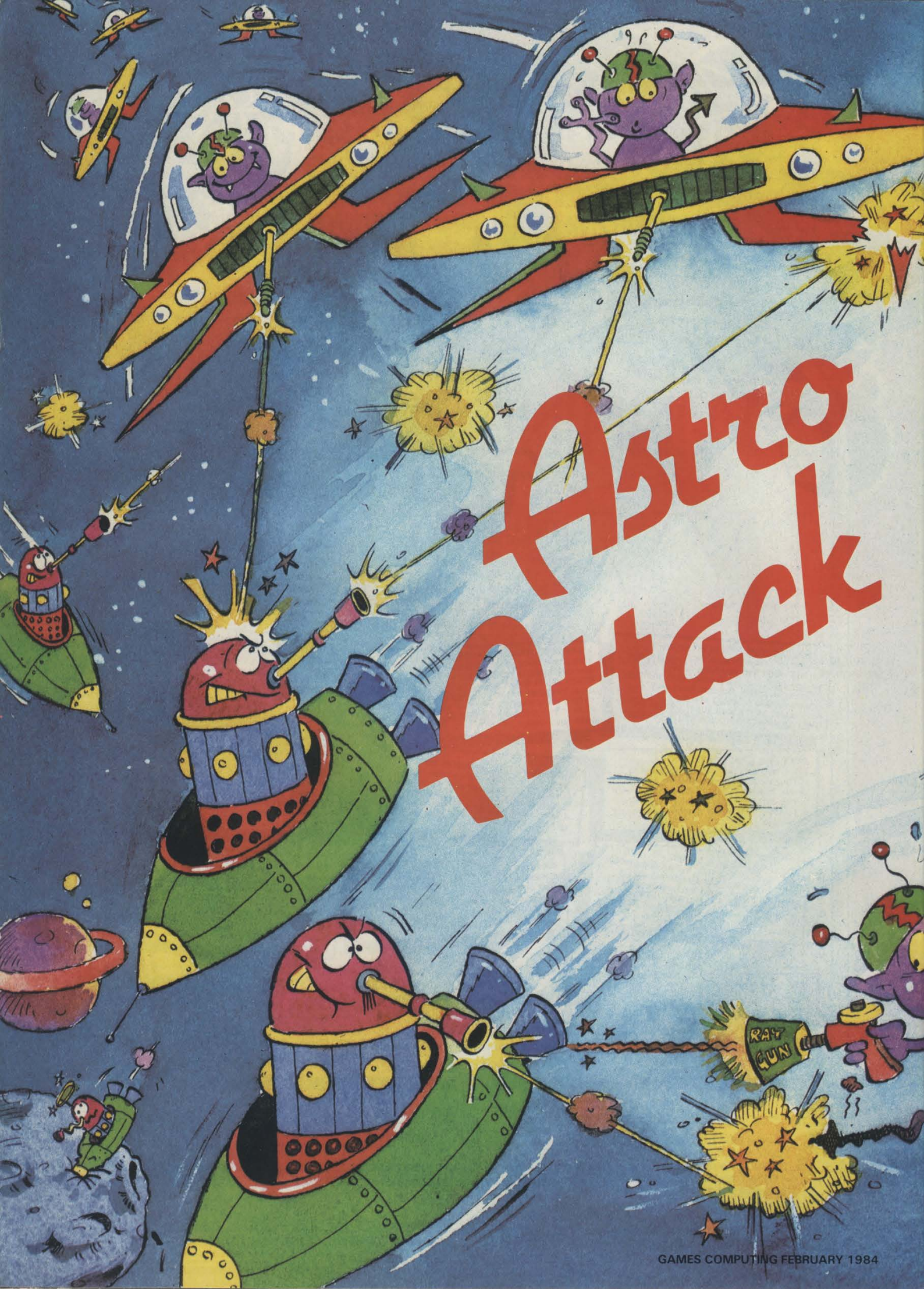

Astro Attack

Astro Attack combines all the Oric colours with a relatively fast and addictive space game.

When the program is run, user defined graphics are set up and the instructions given to you. The program asks you to select a skill level which determines your score and speed of the game. My personal best score was 2532 at the expert's level. You are awarded a bonus of 600 points after 1200 points have been scored.

Once the instructions are over, the screen is set up with the game. On the top right hand corner of the screen is your score, with the high score, fuel supply and lives left recorded on the top left of the screen.

Now for the action: Your ship appears half way down the screen on the left hand side of it, with the enemy putting in an appearance to the right of the screen. Control your own ship using the UP and DOWN cursor keys respectively, the RIGHT cursor key to fire your weapons.

If you choose expert level for skill you lose 10 points if the enemy ship gets past you. Expert level is also faster.

When your fuel is exhausted by gradually going down during the game, you lose a life and start a new game. You also lose lives by crashing into the moving landscape. When all three lives are lost the game ends and you are asked if you want to play again.

When the game starts the enemy ship moves across the screen, weaving up and down as it flies. You just fire your laser gun and shoot down the ship. The game works on a score board. For instance if you try your hand at the expert level you lose 10 points if you allow an enemy ship to get past your own ship. This game runs on a 48K Oric.

Conversion Clues

POKE 618,10	Turns the cursor and keyboard click off.
POKE 48035,0	Should be omitted if programmed for other computers.
PLOT	Should be replaced with PRINT AT.
KEY\$	Should be replaced by INKEY\$.

Colour codes are:

- 0, BLACK.
- 1, RED.
- 2, GREEN.
- 3, YELLOW.
- 4, BLUE.
- 5, MAGENTA.
- 6, CYAN.
- 7, WHITE

ZAP and EXPLODE	Should be replaced by your own machine's equivalent commands.
-----------------	---

If you only have a 16K Oric you can use the program by changing the POKE addresses in which case your best bet is to have a peek at p145 of your Oric user manual.

RUNdown

Lines	Action
10-60	Initialization.
70-270	Set up screen.
300-370	Move your ship.
380-420	Move enemy ship.
430-470	Move landscape.
480	Plots score.
510	Deletes enemy ship.

535	Checks to see if enemy ship has passed you.
540	Checks fuel condition.
560-570	No fuel left.
580	Checks amount of lives left.
600-620	Bonus 600.
640-740	End of game.
760-970	Instructions.
990-1060	User-defined graphics.

Variables Used

LL	=	Lives left
SC	=	Score
HI	=	High score
F	=	Fuel
Y	=	Position of your ship
T,X	=	Position of enemy ship
A\$,B\$,C\$	=	landscape
SS\$	=	Enemy craft
CR\$	=	Your craft
K\$	=	Keyboard inputs
SK	=	Skill level
A,H,I	=	General purpose variables

**Runs on
48K Oric**



```

0 CLS
5 REM ** ASTRO ATTACK BY G.BAILEY **
10 POKE618,10:POKE48035,0
20 PAPER0:INK6
30 GOSUB990:HI=0
40 LL=3:SC=0:A=0:X=0
50 GOSUB760
60 CLS
870 REM ***** SCREEN *****
880 INK5:POKE618,10:POKE48035,0
90 PRINTCHR$(12)
100 A$="????????????????????????????????????????
?????"
110 B$="?      ???? ? ? ? ?      ???? ?
? "
120 C$="      ? ? ?      ? ? ? ?
? "
130 PLOT0,26,CHR$(9)+CHR$(4)+A$
140 PLOT0,25,CHR$(9)+CHR$(6)+B$
150 PLOT0,24,CHR$(9)+CHR$(6)+C$
160 PLOT2,1,"Hi-score "+STR$(HI)+CHR$(7)
:PLOT25,1,"Score "+STR$(SC)

170 PLOT 0,1,7:SS$=CHR$(9)+"x& "
180 CR$=CHR$(9)+CHR$(2)+CHR$(34)+"#$"
190 PLOT0,10,CR$
200 Y=10:X=16
210 PLOT5,3,17:PLOT12,3,19:PLOT30,3,16
220 P 0,3,"Fuel":F=30
230 FORT=6T023:PLOT5,T,5:NEXT
240 IF LL=1THEN260
250 A=20:FORI=1TOLL-1:A=A+5:PLOTA,5,CR$:
NEXT
260 FORT=11T012:PLOT15,T,CHR$(1)+CHR$(10
)+"Ready":NEXT
270 WAIT 200:FORT=11T012:PLOT15,T,"
":NEXT:REM 7 SPACES
280 REM ***** PLAY *****
290 FORT=34T05STEP-1
300 PLOT0,Y,CR$:PLOT2,Y+1," ":PLOT2,Y-
1," ":REM 3 SPACES
310 K$=KEY$:IFK$=""THENK$=L$
320 IF K$=CHR$(9)THENZAP:IFX=YTHENSHOOT
:SC=SC+INT(T):GOTO510
330 IF K$=CHR$(11)THENY=Y-1:L$=K$
340 IF K$=CHR$(10)THENY=Y+1:L$=K$
350 IF Y=24THENEXPLODE:LL=LL-1:IFLL=0THE
N640
360 IFY=24 THEN WAIT 300:GOTO70
370 IF Y<7 THENY=6
380 A=RND(1)
390 IF X<BANDA<.5THENA=.6
4~0 IF X>20 ANDA>.5THENA=.4
410 IF A>.5THENX=X+1:PLOTT,X,SS$:PLOTT+2
,X-1," "
420 IF A<.5THENX=X-1:PLOTT,X,SS$:PLOTT+2
,X+1," "
430 L2$=LEFT$(B$,1):R2$=RIGHT$(B$,35)
440 L3$=LEFT$(C$,1):R3$=RIGHT$(C$,35)
450 B$=R2$+L2$:C$=R3$+L3$
460 PLOT0,25,CHR$(9)+CHR$(6)+B$
470 PLOT0,24,CHR$(9)+CHR$(6)+C$
480 PLOT25,1,"Score "+STR$(SC)+" "
490 IF SC>1200 AND SC<1700 THEN GOSUB600
495 IF.SK=0THENWAIT10
500 NEXT
510 PLOTT,X," ":REM 5 SPACES
520 X=INT(RND(1)*10+5):F=F-1
530 PLOT F,3,16
535 IFT=4ANDSK=1THENSC=SC-10
540 IF F=5THEN 560
545 PLOT25,1,"Score "+STR$(SC)+" "
550 GOTO280
560 FORT=11T012:PLOT12,T,CHR$(8)+CHR$(10
)+CHR$(6)+"Fuel Exhausted":
NEXT

```

```

570 WAIT300:LL=LL-1
580 IF LL=0THENGOTO640
590 GOTO 70
600 FORH=11T012:PLOT12,H,CHR$(8)+CHR$(6)
+CHR$(10)+"BONUS 600":NEXT
610 FORH=SCTOSC+600:PLOT31,1,STR$(H):NEX
T
620 SC=SC+600:FORH=11T012:PLOT12,H,"
":NEXT:REM 12 SPACE

S
630 RETURN
640 REM ***** END OF GAME *****
850 FORT=15T016:PLOT13,T,CHR$(8)+CHR$(10
)+CHR$(5)+"GAME OVER":NEXT
660 WAIT 300:CLS
670 INK3
680 PRINT:PRINT,,," High Score ";HI
690 PRINT:PRINT:PRINT"Your score was ";S
C
700 IF SC>HITHENHI=SC
710 PRINT:PRINT:PRINT:PRINT:PRINT,,,"Agg
in (Y/N) ?"
720 REPEAT:K$=KEY$:UNTILK$="Y"OR K$="N"
730 IF K$="Y"THENGOTO40
740 CLEAR
750 END
760 REM ***** INSTRUCTIONS *****
770 PRINTCHR$(12):INK6
780 PRINTCHR$(4);CHR$(27)"J          A
STRO ATTACK":PRINTCHR$(4)
790 PLOT0,1,3:PLOT0,2,1
800 PRINT:PRINT:PRINT" Your mission is t
o destroy the plague"
810 PRINT"carrying space-craft from the
planet "
820 PRINT:PRINT"of Dione."
830 PRINT:PRINT" With your laser zap dow
n the weaving"
840 PRINT:PRINT"craft by using the right
cursor key."
850 PRINT:PRINT" Position your ship usin
g the up and"
860 PRINT:PRINT"down cursor keys."
870 PRINT:PRINT:PRINT" You have 3 lives
and lose 1 every "
880 PRINT:PRINT"time you exhaust your fu
el."
890 PRINT:PRINT:PRINT,,"Press <SPACE> to
continue"
900 REPEAT:UNTILKEY$=" "
910 CLS
920 PRINT:PRINT:PRINT" Don't crash into
the moving landscape"
930 PRINT"unless you're a kamikaze pilot
"
940 FORT=15T016:PLOT11,T,CHR$(10)+CHR$(2
)+"GOOD LUCK !":NEXT
950 PRINT:PRINT:PRINT"Press A for amateu
r or E for expert."
955 REPEAT:K$=KEY$:UNTILK$="A"OR K$="E"
960 IF K$="E"THENSK=1ELSESK=0
965 PRINT:PRINT:PRINT,,"Press <SPACE> t
o play":REPEAT:UNTILKEY$=" "
"
970 RETURN
980 END
990 FORT=47104+(8*33)TOT+47:READD:POKET,
D:NEXT
1000 DATA 63,63,63,63,63,63,63,63
1010 DATA 63,63,0,7,7,0,63,63
1020 DATA 32,63,63,63,63,63,63,32
1030 DATA 0,60,3,63,63,62,60,0
1040 DATA0,15,31,50,50,31,15,0
1050 DATA 0,60,62,19,19,62,60,0
1060 RETURN

```

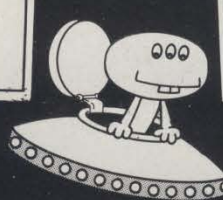
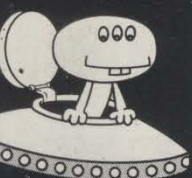
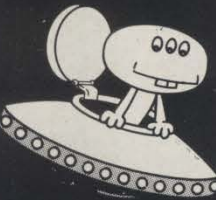

CHRISTINE COMPUTING

TI 99/4A

BLAST IT

Disarm bombs with a wire guided robot, bombs must be disarmed in order within a time limit. 5 levels of play, high score table.

£4.95

CORE!

A three part game, move left and right as you descend through the clouds, birds and aeroplanes. On to the caves and caverns then through the 3-D maze to the Core.

£4.95

FRUIT MACHINE

One arm bandit simulation featuring random hold, nudge and gamble. 'Reels' are fixed and can be learnt but motion is random.

£4.95

UFO

Blast the aliens as they appear from hyper-space, features 3 levels of play, refuel etc.

£4.95

SPUDZ

Score points as you collect potatoes without getting caught in the shadow cast by the setting sun or falling into your trench.

£4.95

COMMODORE 64

MUNCHER

100% machine code game making good use of the sound and graphic facilities of the 64. Munch your way around the maze avoiding the ghosts, etc.

£6.95

Send Cheques and Postal Orders to:

**CHRISTINE COMPUTING, 6 FLORENCE CLOSE,
WATFORD, HERTS WD2 6AZ**

Tel: Watford (0923) 672941

Please add 55p P&P per order.

GET LIQUIDATED!

Introducing five great new games from CCS guaranteed to give you plenty of trouble.

You'll get no peace in the prohibition days of **Gangsters** - if the cops don't get you, your rivals will. Try keeping your head above water in **Brewery** - a game all about liquid assets. We'll try our hardest to sink you in **Plunder** - a world of Elizabethan piracy. And we're sure **Battle 1917** is more than a match for anyone - it should be - it won the Cambridge Award.

As if that's not enough, we've even

created **Abyss** - a feast of excitement and hidden danger for those who dare defy the evils to be found beyond the Mountain of the Golden Lion.

So if you want trouble - we've got the games.

All available for Spectrum 48K at £6 (Abyss £5). Selected titles available from W.H. Smith, Boots, Rumbelows, Greens and all good computer shops or

Cases Computer Simulations Ltd.,
14 Langton Way, London SE3 7TL.



CC Strategy Games.
S They're no pushover.

1st WORLD VIDEO GAMES COMPETITION

The first world video games competition is on its way.

Due to be held during 1984 there is a \$100,000 prize for the inventor of the winning video game. And the event is to be televised in a spectacular worldwide show during the autumn of 1984. This will be done by a specialist in presenting such shows as Miss World, the Wimbledon tennis tournament and the US and British Open Golf Tournaments. All the six finalists in the competition will appear on the show and the ultimate winner will be handed his advance on expected royalties for his winning game.

With the marketing for the winning games being handled by the famous Mark McCormack's organisation the International Management Group the games will have worldwide exposure. He's the man who has made fortunes for great sportsman like Bjorn Borg and Arnold Palmer — who knows, you could be next!

The competition has been organised by Video Games International of Buckinghamshire, and there are six categories which you can enter. These are SPORTS SIMULATORS, ARCADE, ADVENTURE/FANTASY, STRATEGY and PUZZLES with a special award for any games with particular educational or entertainment value.

If you fancy yourself as a millionaire inventor of video games you can write an (original) program for any of the popular home computers. That means the Spectrum, VIC-20, Commodore 64, Atari, Oric, BBC B to name but a few.

All entries must be sent to Video Games International on standard audio cassettes along with a written description of the game play which must include any special features of the game.

You must also remember to give specific details of the computer which you wrote your game for and your full name and address.

Eventually VGI want to create a special register called the International Register of Videogames Inventors Limited. This will contain names of inventors and their games creations and will be permanently available for international manufacturers who are scouting around for new products to market. VGI stresses that only inventors of 'high merit' games will be included in their bible of products.

Once the winning games have been decided the International Association of Video Games Inventors intends to send out the best six games to TV stations, newspapers and magazines throughout the world in order to organise a playing competition of the games to find the International Video Game Player of the Year. He or she will win \$100,000 and the final of this grand competition will be held in the Autumn of 1985, coinciding with the IAVI's announcement of that year's winning games.

If you're interested in this competition why not send your entry straight to Video Games International at Pinewood Studios, Iver Heath, Buckinghamshire SLO 0NH or if you want to find out more details about the competition and its rules drop them a line asking for further information.

Good luck — and if you win and turn out to be a millionaire the editor says she wouldn't mind having a cut of it too!

Rock 'n' Rolling With K-Tel

K-Tel International is the latest record manufacturer to launch into the booming computer games software market.

The first of what the firm hopes will be a string of hits is for a series called Doublesiders. This means that you get two games for the price of one kicking off with games for the ZX Spectrum and VIC-20.

Of the first batch of goodies K-Tel is keeping its ties with its heritage with a game called 'It's Only Rock 'n' Roll'. This is an adventure game in which you take the part of an up-and-coming young hopeful in the music making business. It's up to you to plot your course to success and reach the status by the likes of Boy George or the Rolling Stones. Do you want to begin by busking round the countryside or play in the pubs and clubs in London using as a platform to launch your career to stardom? If you do, then this game is a must for you.

On the reverse side of this tape is another adventure this time taking the traditional theme of Dracula. You are stuck in Dracula's tomb and must try and escape from it before he reaches you and sinks his teeth into you. Your only hope is to find your way out of the tomb by using your brains and cunning, oh, and there are also seven silver stakes which you must use to kill Dracula if the occasion arises.

Other K-Tel games to look out for include Battle of the Toothpaste Tubes/Castle Colditz (48K Spectrum), Alien Swarm/Arena (16K Spectrum), Supavadres/Bomber Run (VIC-20), and Plageu/Alein Demon (VIC-20 with 8K expansion.)

K-Tel is going into this line of business in a big way with the policy of offering the public 'great quality at great value' and 'top class games at competitive prices'. The firm is launching their brand new range of games via television national press advertising so watch out around on your telly for news of their games. You'll find the K-Tel game on sale in all the large multiples now with further releases due for the Commodore 64 as well as other machines. Prices of the games are £6.95 which sounds like good value money to me.

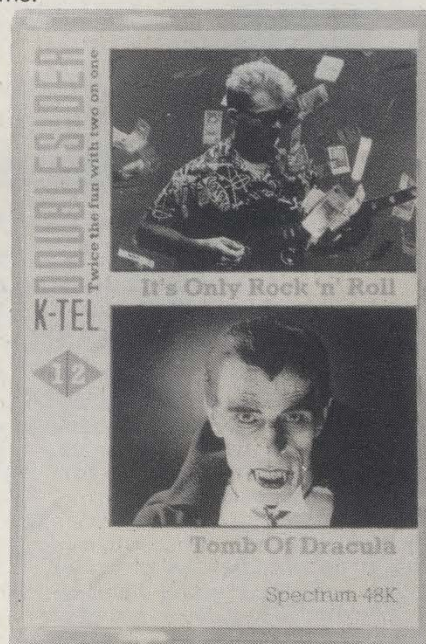

BRICKIE'S BOOST ON ATARI

Ever fancied yourself as a well-paid brickie? Well now's your chance to do just that with the help of English Software's new game for the Atari computer.

Batty Builders sounds like a bundle of laughs as long as you don't mind running the risk of being crushed under the weight of falling breeze blocks. What you must do is rush around the screen catching breeze blocks as you go and as you pick them up free yourself to catch more by building walls. All colour action is a feature of this game with eight different skill levels to tax even the most adept of brickies.

Following hot on the successful heels of English Software's Airstrike is Airstrike 2. This game falls into the Defender category in which you bomb and fire at the enemy while flying over a particularly hazardous terrain. English says it is an 'even more challenging game' and comprises new landscapes, a joystick bomb control and a 'host of new hazards'! If you Airstrike fans are a glutton for punishment this could very well be the game you have been looking for.

Two adventure games for the Atari are on tap from English (at a price of course). These are Caverunner and Captain Sticky's Gold. The first is all to do with

Kong's Kingdon where you must cross dangerous waterfalls, exploding volcanoes and enter the fire and water caverns in search of the 'hidden jewels, chalices and treasures'. The latter of the two is an underwater chase in which you must rescue loads of lost gold. But while you're doing that you have to avoid MX missiles. Forcefields, man-eating crabs and oxygen-hungry leaches. And that's beside the lethal fish. Sounds like something to make a meal of!

And for the Commodore 64 there's a great new adventure game whose scenario is set underwater in Neptune's lair. It is a multi-screen adventure in which Neptune's daughters are held captive in a secret underwater cavern by slithering sea snakes. And it's up to you to rescue them before their oxygen supply runs out — and that's likely to happen very quickly. But first of all you must devise a cunning way of luring the sea snakes away from their new-found prey. Only by trial and error will you find out how you can save each of Neptune's daughters.

You can buy any of these titles for the Atari and Commodore 64 computers from branches of Boots, Greens and Laskys as well as from dealers of the Atari and Commodore 64. Otherwise contact the firm at Box 74, Manchester M60 or telephone them on 061-835-1358.

PENDULUM OF DEATH

You'll be swinging in suspense in Satan's Pendulum as you tackle the traumas of Edgar Allan Poe's horror stories.

The idea of the game is to rescue the captive heroine, Pixel Ramtop, from the centre of Prospero's castle. She is trapped in the torture chamber of the castle tied up underneath a slowly descending pendulum. But the journey to the centre of the castle is no easy one and you must beware the evil killer monsters who jealously and loyally guard the rooms of Prospero's castle.

There are three different scenarios to test your trauma-taking capacity as well as four skill levels and animated cartoon graphics to illustrate the game. You can also use Kemptson joysticks with the game. Coming with the tape is a booklet of rules and advice on how to approach strategy to play the game. Also included in the game book are descriptions of the procedures used to create the animated cartoon graphics giving examples of the techniques employed designed to help users incorporate them into their own programs.

Satan's Pendulum costs £5.95 and you can buy copies from the producer Minatron Computing, 34 Pirewood Close, Westbury on Trym, Bristol BS9 4AJ. You can also ring them on Bristol 623597.



PSS... WHO ARE THE KRYALS OF ZONG?

What on earth will you find in the Kryals of Zong and who is lying in wait for you to tackle them in Neoclyps?

You'll only find out in these brand new games for the Commodore 64 just released by PSS. These are only two of the five zany names games to hit the streets. Other new titles from PSS are Metro Blitz (in the picture) which looks like certain fun, games and frustration to me, then there's Moby Dick which sounds as if it could have something to do with the story of a giant whale who only liked eating humans! Cosmic Split is a space game — but all of them have been written as adventure

games.

These new tapes cost £7.95 each and are available either mail order from PSS itself or you can buy them across the shelves of Boots, Smiths, Menzies, Selfridges and Comet.

PSS is quite well established in the computer games software market having produced products each month for a variety of machine such as the Spectrum, Oric 1, Dragon 32, ZX 81, BBC B, and Commodore 64, (or Commodore 84 as the press release says!).

More information about PSS's products can be obtained directly from them at 452 Stoney Stanton Road, Coventry, West Midlands. If you want details more quickly you can telephone the firm on 0293 667556.

NEW TWO-COMPUTER GAME

Just out from Protek is a novel idea for a computer game in the form of Hunter-Killer which can be played on one computer or two!

Protek claims the new game is unique because of this design feature. The game enables you to link up two computers and the cassette contains two versions of Hunter-Killer. One is for a solo computer and the other runs on two computers.

The idea of the two-computer game version is that two players can play against each other in a 'hide and seek' game. So gives that Hunter-Killer is a submarine simulation one player will be hiding his target, while the other is seeking it. It certainly sounds very interesting indeed.

An expert from Protek described it being similar to playing a dual game of chess and says that it opens up all sorts of possibilities for games players. Like using a modem via a telephone to play games with a colleague remotely. As far as Protek is aware this is the first time a game of this sort has reached the saleable stage. The firm is very excited about their new product and are delighted to report that it is selling very well, with dealers banging on Protek's door for more copies of the game.

The game itself sports high resolution graphics (of course), 18 control functions, four different levels of difficulty, Asdic radar and depth sounder, visible torpedo tracks, live enemy target, animated sea view and 3D view of the target.

Protek has plans afoot to develop further games of this nature but are safely keeping any ideas under their hat for the time being! Hunter-Killer costs £7.95 and is on sale in all the large multiple stores.

If you want to get in touch directly with Protek you can contact them at Unit 1A, Young Square, Brucefield Industrial Park, Livingston EH54 9BX. Or telephone them on Livingston (0506) 415353.

The BBC Micro can now give your children a private education.

The BBC Microcomputer now accounts for 80% of the computers being ordered under the current D.O.I. Primary School Scheme.

It's also the computer which a rapidly increasing number of people are choosing for their homes.

One of the reasons for its success is that it makes learning highly entertaining for everybody. From children who are getting to grips with the alphabet, to adults who want a gentle but intensive introduction to the complex world of computing.

Now, there's a substantial new catalogue of educational programs specially for the BBC Microcomputer.

It has been developed by Acornsoft, the software division of Acorn Computers who manufacture the BBC Micro.

Making faces without getting scolded.

With the new Facemaker program, your children can make over a million faces. It's like an identi-kit, allowing them to depict anyone they want. They start by choosing the eyes. Then they can choose the mouth, the ears, the nose, the facial outline and the hairstyle.

And if they really fancy dressing up, they can add earrings and hats.

In doing all this, they learn to read and spell, as well as developing their powers of description.

The money program, two games for the price of one.

Mr. T. is an engaging little figment of the microchip who can teach your children all the complexities of our coinage system.

His Money Box program has two games, each of which can be played at different levels.

In Money Match, the challenge is to collect a set of coins, matching them according to shape, size and value.

In Money Box, you can give your child and Mr. T. a helping hand to get all the coins on the screen into the box. (It's always different, because the coins on the screen are based on the small change you have to hand.)

A chance to teach the Micro a thing or two.
With the Animal, Vegetable, Mineral program, the children can get the computer guessing.

They think of an object. The BBC Micro has to decide what it is.

If it doesn't come up with the answer, the children can keep giving it hints.

In doing so, they are encouraged to question the difference between such things as crocodiles and alligators, or whether oil is vegetable or mineral.

The program also encourages them to consult refer-

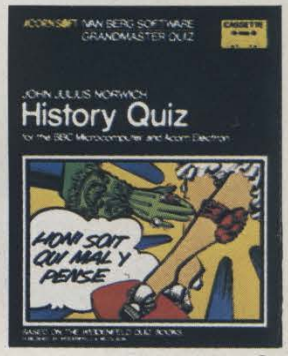
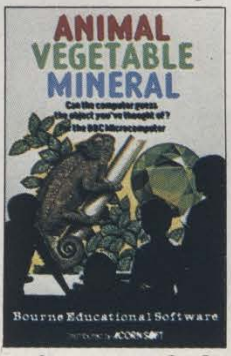
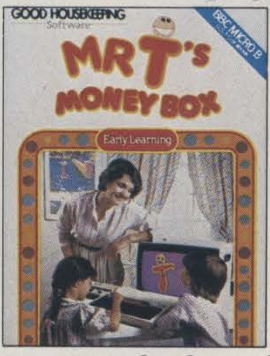

ence books so that they can ask the computer increasingly tough questions.

Questions on Julius Caesar from J. Julius Norwich.

John Julius Norwich's History Quiz is one of the new BBC Micro Grandmaster quiz series which also covers theatre, crime and detection, music, science fiction and royalty.

On the history front, there are 300 brain-testing questions, covering all aspects of British history from Julius Caesar to Margaret Thatcher.

And to increase the educational value, Mr. Norwich has posed the questions from angles which will give a broader understanding of events.

For the full catalogue, clip the coupon.

There are thirty more new BBC Micro programs in Acornsoft's new catalogue.

For a free copy, complete the coupon, or telephone 0933-79300. Or ask your local BBC Micro dealer.

If you're not yet a BBC Micro owner, you can get full details of the computer at the same time.

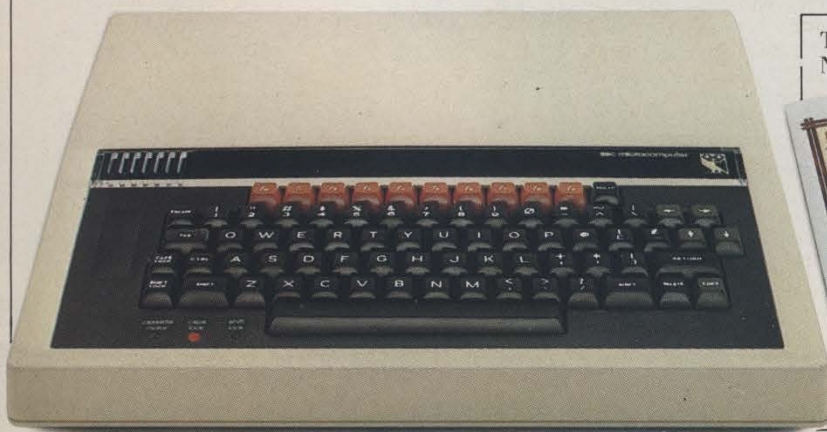

To Acornsoft, c/o Vector Marketing, Denington Estate, Wellingborough, Northants NN8 2RL. Please send me the new Acornsoft catalogue "At Home With The BBC Microcomputer."

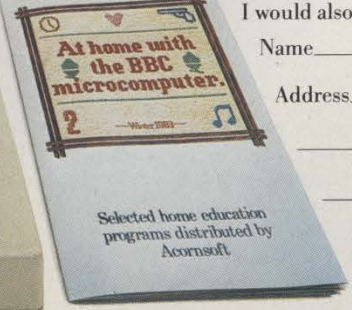

I would also like details of the BBC Micro (tick)
 Name _____
 Address _____

 Postcode _____

ACORNSOFT

JUST AROUND THE CORNER, A NEW



BLACK CRYSTAL

The Classic, six program adventure game for the 48K Spectrum and 16K ZX-81 computers. No software collection is complete without it.

"BLACK CRYSTAL is an excellent graphics adventure and a well thought out package" (Sinclair User, April '83).

"BLACK CRYSTAL has impressed me by its sheer quantity and generally high quality of presentation. I am afraid I have become an addict" (Home Computing Weekly, April '83).

SPECTRUM 48K 180K of program in six parts . . . only £7.50

ZX-81 16K over 100K of program in seven parts . . . only £7.50

Why pay more for less of an adventure?



ZX-81 COMPENDIUM

Alien Intruder, Wumpus Adventure, Numerology, Hangman, Hieroglyphics, Movie Mogul.

The ideal software package for all 16K ZX-81 owners. Six major programmes on two cassettes for only £6.50.

"Alien Intruder/Hieroglyphics — Both programs make good use of graphics and words to make a very entertaining package." (Sinclair User, Aug '82)

"Alien/Hieroglyphics/Wumpus/Movie — A varied mix from Carnell, all featuring imaginative responses and graphics and all of them good games for all ages (Hieroglyphics is particularly good for children)." (Popular Computing Weekly, Aug '82)



THE ADVENTURES OF ST. BERNARD

An exciting, fast moving, machine code, arcade game where you guide your intrepid St. Bernard through the perils of the icy wastelands to rescue his Mistress from the clutches of the abominable snowman. 48K Spectrum £5.95.

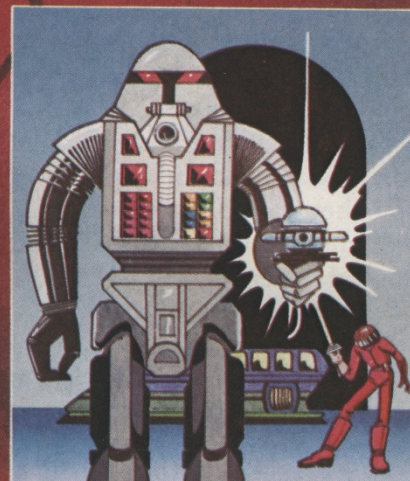

STARFORCE ONE

Take on the robot guardians of the central computer in a superbly stylised three dimensional battle game. 48K Spectrum £5.95.

(100% MACHINE CODE ARCADE ACTION)



THE CRYPT

written by Stephen Renton

Prepare yourself for the many challenges that shall confront you when you dare to enter "THE CRYPT".

You will battle with giant scorpions, Hell spawn, Craners, Pos-Negs and if you are unlucky enough — the Dark Cyclops in this arcade style adventure.

Available now for the 48K Spectrum @ £4.95



THE DEVIL RIDES IN

I uttered the last incantations as the clock struck thirteen. All fell silent except for a faint rustling in the corner. From out of the shadows they came, all Hell's fury against me but I was not defenceless until the Angel Of Death, astride a winged horse, joined the battle. Avoiding his bolts of hell fire, I took careful aim. My chances were slim, but if my luck held . . . 48K Spectrum £5.95.

(Fast moving, machine code, all action, Arcade game)

RANGE FROM CARNELL SOFTWARE



COMING SOON "THE WRATH OF MAGRA"

The first born has been destroyed. The Black Crystal of Beroth has been banished. The alliance of Evil has been defeated by the armies of Lord Fendal. So ends the Third Age. Now we invite you to write your name in the history of the Fourth Age of the Third Continent.

You will meet friends and enemies, old and new, in the long awaited sequel to Volcanic Dungeon. Using high resolution graphics and combining the best qualities of "Black Crystal" and "Volcanic Dungeon", we will allow you to become part of this tale of revenge.

"The Wrath Of Magra" comes as three, 48K programs on cassette, boxed with instruction manual and book detailing the history of the Third Continent and the many spells you will be using throughout the game.

NOTE: "The Wrath Of Magra" is a complete adventure. You need not buy "Volcanic Dungeon" or "Black Crystal" to play it.

Available through most good computer stores or direct from:
Carnell Software Ltd, North Weylands Industrial Estate, Molesey Road, Hersham, Surrey KT12 3PL.
Dealers: Contact us for your nearest wholesaler.



CARNELL SOFTWARE LTD



The Runaway Robot Replies

Dear Editor

The other day I went into W H Smiths and saw your new magazine shining like a beacon amongst all the other computer magazines! At first I thought, 'Oh no, not another one'. But now I've changed my mind. Being a computer and video games addict I thought I might as well buy it. Wow! — Was the first word that came into my mind. It's Great! I like lots of it — the programs you printed, the news section with all the latest software releases, the special features on toys and joysticks and the competitions, and the pretty pictures.

All I can say is: more, more more!!!

Oh no, there is one other thing. As I'm a keen programmer I'd like to see a bit more on the programming side. How about it?

Looking forward to the next *Games Computing*...

John Green
Manchester

Funny you should mention that John because what we are planning to do is start a page which our Software Assistant, Simon Rockman, will help out all budding programmers, or any readers who have trouble of a technical nature with any of the programs printed in the *Games Computing*. (Of course, he's going to make sure that no mistakes creep in to the listings we print but there are almost bound to be points which you would like to take up with some of them). So your chance to actively participate in a regular programming feature will soon be in here to take advantage of. Simon's putting his brainpower to deal with it at this very moment so watch out for it in the next issue of *Games Computing*.

Apart from that there is of course our regular programming feature on learning machine code which all gamers are keen to do. And another regular hot

spot is our series on Wargaming. This will be of interest to all people who like computer war games, which until recently were few and far between for use on home microcomputers.

I hope that all keeps you out of trouble for a while John!

Dear *Games Computing*

Congratulations on producing an interesting and fun magazine for us computer games players. But why can't you do a cartoon strip like some other mags do? I think they're great fun to read and sometimes very funny to look at too with good drawing done. If you put a cartoon page in your magazine I'll buy it for ever!

Bye...
James King
Bath

Thanks for your enthusiasm James and I'm only sorry that we haven't kept everyone happy with the first issue, but we're trying hard! We didn't put a cartoon strip to do with computer games for the very reason you mention — other magazines do just that and we want to be a little bit different.

However, you'll be interested to know that we are working on a special project along the lines of a cartoon but with a difference which we hope will be in *Games Computing* regularly very soon. I can't say too much about it now but it really will be a special sort of cartoon. At this very moment in time our backroom games slaves are working out the nitty gritty of the details.

I hope that will make sure you become one of our regular readers and don't miss a single issue of *Games Computing*!

Dear Sir or Madam

My young son rushed home with his issue of *Games Computing* clutched in his hands and avidly read the software reviews section. I must admit I sneaked a look at it after

I managed to prize it from his fingers and although much of it (the programs) passed over my head I found the review section extremely useful in selecting his Christmas presents. Both the software section (apart from the fact that it was a little difficult on the eye) and the joystick section gave me some insight into exactly what is available. Well done!

One word of advice I would like to offer — please can you make less of the violent types of computer games and more of the entertaining ones please. Speaking as a mother I feel that children are being influenced by the violence portrayed by many of these computer games on sale and it is not altogether a good thing.

Yours sincerely
Mrs A Hare
Willsden

Thank you for your letter, Mrs Hare. It is encouraging to hear from people such as yourself and I am glad that you found our first issue helpful, and by the sound of it kept your son occupied for a while! I appreciate your concern about the theme of many computer games involving shooting, killing and general destruction. However, there are two schools of thought on the subject. One is set dead against computer games and the other is not. I believe that children realise that the characters in such games are fictitious mainly as they are so unrealistic that they appear to come from another world. Software firms producing such games certainly don't advocate everyone should gaily go around killing people — indeed there is always a point to the destruction, even if it is only to save a fictitious city from an enemy race. There are also those that reason it is better that people vent their aggression on a television screen via a game than it is to go out and vent it in reality.

At *Games Computing* we put the emphasis on fun. It is also a fact of life that the 'space invader' type of game is still enjoying widespread popularity amongst children who consider it to be a fun game.

We aim to make computer and video games as fun for everyone as possible, and that involves battle type games.

Dear Games Computing

First of all, thanks for an exciting new magazine to lift me from the doldrums of computer magazines in general.

I liked your first issue but want to reserve judgement for a few issues yet, but I hope you can keep up the standard you first achieved.

There were a couple of things that struck me when I read *Games Computing*. The first was the Video Games section which I was glad to see in the magazine. The only thing was that most of the games were from Atari and all were for the Atari. Please will you do some for other VCS type systems? Especially the Colecovision (my little brother has one) and the Intellivision (a friend of mine owns one of those). I know that sounds selfish, but I'm sure lots of other people own all these systems too.

Do you want any reviewers for those machines? If you do I would be delighted to help out by writing some for you.

The other thing was on the software review pages. I couldn't read it with those stamps plastered all over the place! You'll have to give some special glasses away with the magazine if you keep doing that. Yours sincerely
Tim Madden
Burnt Oak

Thanks for your comments Tim. The first issue did include a lot of Atari reviews but we do, in the future, aim to print reviews of games for many of the other VCS machines, including those you mention. In fact, the Colecovision is indeed featured in this month's Video Vying section. So your little brother will be kept happy for a while, at any rate.

Yes, we do want reviewers to put in our file of those with VCS systems. All the popular machines will be catered for on the games review front so anyone that owns an Atari VCS, Intellivision, Colecovision or Philips G7000 can join our elite team.

If you want to be a reviewer, or your brother, all you need do is write in to us

at *Games Computing* giving details of your own system, what games you would particularly like to review and your address and telephone number.

The same goes for software reviewers too. If anyone owning a computer wants to review software for *Games Computing* write to us at our Golden Square address giving full details of your computer system and the sort of stuff you are interested in reviewing. We'll do our best to let you review what you want. We've got lots of games software just waiting to be packed up and sent off to reviewers so you'd better get in quick if you want to be one of the first!

And now to our software reviews pages. I admit those pages are a shock to the eye at first but it doesn't stop you being able to read what lurks underneath those stamp marks. Our designers of the magazine thought the idea was great, 'a new concept in design' they said, but we'll just chalk it down to experience! Sorry about that folks. We'll try and do better next time.

Dear Games Computing

I bought the first issue of your brand new magazine and was pleased to see such a fresh approach to computer games.



Have you got any opinions to air, has someone somewhere upset you and you want to grizzle and gripe? Or maybe you're full of the joys of spring and feel like telling a happy story?

Whatever you want to say, be it good, bad or indifferent drop us a line here at Games Computing and get it off your shoulders.

Send your letters to:

'Postman Pat', Games Computing, 1 Golden Square, London W1.

You're right — we games playing fanatics do take our computer and video games seriously!

You've hit the nail right on the head. I liked the mixture of programs you put in to the magazine and thought some of them were great, and I especially liked the colourful illustrations to go with them. I hope you're going to keep doing that.

What I wondered about was sending in programs for *Games Computing* to publish in future issues of the magazine. I've thought up quite a few ideas and have written one or two games programs. What do I do about sending them to your magazine? And what sort of programs do you want to put into it?

From: an eager games player
Simon Northcott
Wallington

Well, Simon first of all we're all pleased to hear that you liked our first issue and plan to make sure you continue to enjoy forthcoming copies of it. Yes, we are going to keep putting nice, bright colour illustrations in the magazine — the more the merrier.

Now for the programs. Any program which is a game will suit *Games Computing* right down to the ground. Anything from arcade space games, to adventure games, thinking games, wargames, sports games, maze games and strategy games. They can run on any of the popular home computers like the VIC 20, Spectrum, Commodore 64, BBC B, Electron, ATARI, TI 99/4a and Oric, or for machines like the Sharp, TRS 80 — virtually anything that you think is a popular home computer. We'd love to hear what you think about games programs, and tell us what you'd like to see by sending in your own programs.

As for sending them in to us — all you need to do is fill in the Program Submission form which will be in each issue of *Games Computing*. Make sure you send us all the things asked for on the form. Also you make sure you send it to:

Games Computing,
1 Golden Square, London W1

But to save you all flicking to that page, here's a brief rundown of what to send.

1. A tape clearly marked with the name of your program and your name.
2. Anything that you've written about the program, explanatory notes, details about loading the program, and special features you've cleverly included in your game — really anything which will be useful for other readers to know in order to type in your game.
3. The completed Program Submission form taken from the magazine.
4. A program listing — with good, clear print — if you can get hold of a printer, or failing that just send us the tape containing your game.

CALPAC LEARNING SERIES

Colour graphics and sound are used extensively to make learning more enjoyable.

5. MULTIPLICATION TABLES. This program with correction sequences enables you to test individual multiplication tables, or all tables up to a maximum that you choose. Carriages are added to a train as the score increases - see the train glide through the countryside when the test is finished.

6. THE ROMANS. Answer questions on the Romans to win a horse, chariot, viaduct and temple. Answer enough correctly and the horse will gallop away with its chariot.

7. SPELLING TESTER. The words in the test are initially displayed on the screen. Then short sentences are used as prompts for the words, which must be typed correctly to add stages to a space-ship.

Replace the words and sentences in the program with weekly spelling lists, save them on cassette, and you will rapidly create a whole library of programs.

8. HOMOPHONES. Sale or sail, bare or bear? Choose the correct word to complete the sentence. Extra motivation is provided by a coloured pot-plant, which grows with each correct response. The plant flowers in an unusually tuneful fashion at the end of the program.

© J. J. Warren 1983

Published by Calpac Computer Software, 108 Hermitage Woods Crescent, St Johns, Woking, Surrey GU21 1UF

The programs on this cassette are subject to copyright, and may not be copied, transmitted, hired or lent without the written permission of Calpac Computer Software.

CALPAC



CALPAC LEARNING SERIES

ZX
SPECTRUM
VOL. 2

CALPAC



CALPAC LEARNING SERIES

PROGRAMS 5-8

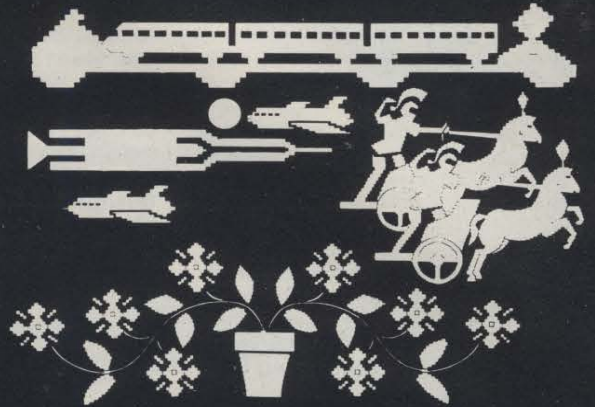

5. MULTIPLICATION TABLES
5. THE ROMANS
7. SPELLING TESTER
8. HOMOPHONES

SPECTRUM 16K
FROM 7 YEARS 48K

CALPAC LEARNING SERIES

Colour graphics and sound are used extensively to make learning more enjoyable.

9. NOUNS, VERBS, ADJECTIVES AND ADVERBS. Sentences are displayed and you select the named parts of speech. Instant feedback and helpful comments ensure positive learning. Correct answers are rewarded by the creation of a coastal scene, which is animated at the end of the program.

10. VERB PRACTICE. You have to complete the sentences using the correct tenses of the verbs. The program concentrates on those irregular verbs that often cause difficulty. An underwater landscape is created as questions are correctly answered.

11. THE STRUCTURE OF THE FLOWER. This program explains how the parts of the flower are involved in the formation of seeds. This is a three part program which makes full use of high resolution colour graphics.

12. LONG DIVISION. This detailed program takes the learner through long division sums in easy stages. Correction sequences are automatically provided when they are needed. Sums with remainders can be chosen if required.

© J. J. Warren 1983

Published by Calpac Computer Software, 108 Hermitage Woods Crescent, St Johns, Woking, Surrey GU21 1UF

The programs on this cassette are subject to copyright, and may not be copied, transmitted, hired or lent without the written permission of Calpac Computer Software.

CALPAC LEARNING SERIES

ZX
SPECTRUM
VOL. 3

FROM
9
YEARS

CALPAC



CALPAC LEARNING SERIES

PROGRAMS 9-12

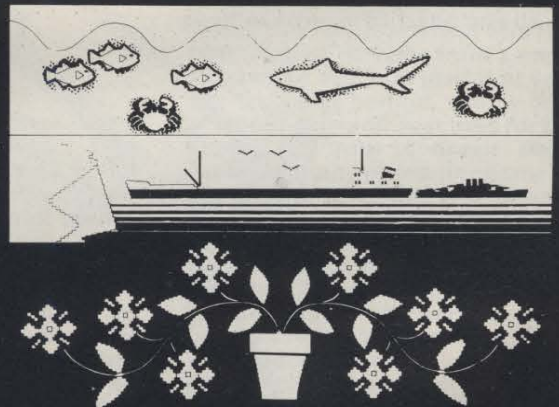

9. NOUNS, VERBS, ADJECTIVES AND ADVERBS.
10. VERB PRACTICE
11. THE STRUCTURE OF THE FLOWER
12. LONG DIVISION

SPECTRUM 16K
FROM 9 YEARS 48K

Our software is suitable for use in the home, school or college.

For further details or retail stockists please telephone:- 048 67 2584

We have a demonstration cassette available for retailers or schools.

We would like to hear from good programmers, graduates or teachers wishing to participate in the expansion of our Learning Series on the Spectrum, BBC Model B and other machines.

Our software is available by direct mail from:-

CALPAC COMPUTER SOFTWARE
108 Hermitage Woods Crescent
St Johns, WOKING, Surrey GU21 1UF

PRICE LIST

CALPAC LEARNING SERIES VOL 1
CALPAC LEARNING SERIES VOL 2
CALPAC LEARNING SERIES VOL 3
CALPAC CHEMISTRY SERIES VOL 1
CALPAC CHEMISTRY SERIES VOL 1
CALPAC PATTERNS

16K or 48K Spectrum £9.50
16K or 48K Spectrum £9.50
16K or 48K Spectrum £9.50
48K Spectrum £7.50
16K ZX81 £6.95
16K ZX81 £5.95

Additional features of the CALPAC LEARNING SERIES include:-

- *Spelling checkers
- **"Help" call up routine
- *Easy insertion of subject material of your own choice into the programs

This game, written for the 48K Oric is a non graphical version of the well known board game which relies on coloured pegs and a peg board. If you have ever played MASTERMIND using the coloured peg idea, you will agree with me that it is very frustrating when, half way through a game you run out of pegs or the board tips up and all the pegs fall out. All your problems have now been solved with this amusing, number based version of MASTERMIND.

The idea is exactly the same, so is the scoring. The only thing that is different is that instead of coloured pegs, numbers are used ranging from 0-9.

The main part of the program is creating the hidden code, checking your guess and printing the result. Arrays were chosen to hold the guess and the code rather than variables because arrays are much easier to handle. The contents of an array can be input and checked using for/next loops. This is not possible with variables.

When the program is run, the first thing that you see is the instructions. These instructions explain the idea of the game and how to play. If you are a beginner to the game whether it be computerised or not and are not exactly brilliant at solving a code then you will probably need to have many goes, therefore you input a high number when you are asked to enter the 'number of goes you require'.

There is no function to allow you to refer back to the instructions during the solving of a code so make sure that you remember what the result that you receive after each guess means. When entering in your guess there is no need to hit return because the GET function is used. But make sure you know what your guess is going to be before you start entering as you cannot delete your entry. The only time you have to hit the return key is when you enter the number of goes you require.

If you like the idea of I've Started So I'll Finish but you don't have an Oric but a different computer then fear not for I have included the functions of most of the lines of the program, explained all the variables and translated some of the Oric BASIC.

- 5 sets toggle switches to zero and switches off caps lock.
- 10 sets background colour to black.
- 15 sets three variables and jumps to the instructions routine.
- 20 sets foreground colour to red and switches off the sound generator.
- 30 turns the contents of V\$ into a numerical value.
- 35 makes a noise and clears the screen.
- 40 produces the four bit code held in array N(C).
- 65 pauses for 40 x 1 hundredths of one second and makes a ping noise.
- 70 allows you to enter your guess.
- 75 checks to see if any digits of your guess are right and in right place.

I've Started

10

```

0 REM
5 POKE#26A,10:PRINTCHR$(20)
10 PAPER0
15 Z=0:R=0:W=0:GOSUB200
20 INK2:PRINT:PLAY0,0,0,0
25 PRINT"ENTER NO. OF GOES YOU REQUIRE"
30 INPUTV$:V=VAL(V$)
35 PLAY1,1,1,300:CLS
40 FORC=1TO4:N(C)=INT(RND(1)*9):NEXTC
45 PRINTCHR$(133)"ENTER GUESS WHEN YOU HEAR THE PING"
50 PRINT
55 FORX=1TOV
60 FORC=1TO4:M(C)=N(C):NEXTC
65 WAIT40:PING
70 FORC=1TO4:GETG(C):PRINTG(C);:NEXTC
75 FORC=1TO4:IFG(C)=M(C)THENM(C)=.9:R=R+1:G(C)=.6
80 NEXTC
85 FORC=1TO4
90 FORD=1TO4:IFM(C)=G(D)THENM(C)=.8:W=W+1:G(D)=.7
95 NEXTD:NEXTC
100 Z=Z+1:PRINTCHR$(131)"          R";R;"          W";W
105 IFR=4THENGOTO130
110 R=0:W=0
115 PRINT
120 NEXTX
125 GOTO170
130 INK5:PLAY1,1,6,100:MUSIC1,6,1,0:CLS:PRINT:PRINT
135 PRINT"Well done! You cracked the code..."
140 PRINT:PRINT"It was ";N(1);"";N(2);"";N(3);"";N(4)
145 PRINT:PRINT"It took you ";Z;"tries to solve it..."
150 PRINTSPC(171)SPC(171)
155 PRINTCHR$(140)"HIT THE SPACE BAR TO PLAY AGAIN"

```

So I'll Finish...



```
160 REPEAT
161 INKINT(RND(1)*7)+1
165 UNTILKEY$=" ":CLS:WAIT200:PLAYO,0,0,0:GOTO15
170 FORN=1TO3:PLAYO,1,1,3000:WAIT100:NEXTN:EXPLODE:CLS
175 PRINTSPC(133)SPC(133)
180 PRINTCHR$(129)"          You lose"
185 PRINTSPC(152)SPC(152)
190 PRINTCHR$(130)CHR$(140)"HIT THE SPACE BAR TO PLAY AGAIN"
195 GOTO160
200 PLAYO,1,3,500
205 INK2
210 CLS:PRINT:PRINT" I'VE STARTED SO ... "
215 PRINT:PRINT:PRINT" The object of this game is to work"
220 PRINT:PRINT"out the hidden number that's held"
230 PRINT:PRINT"inside the computer."
235 PLOT1,26,"HIT THE SPACE BAR TO CONTINUE"
240 REPEAT
241 INKINT(RND(1)*7)+1
245 UNTILKEY$=" ":CLS:WAIT10:INK6
250 PRINT:PRINT
255 PRINT:PRINT" Every time you input your guess"
260 PRINT:PRINT"you get in return a set of numbers."
265 PRINT:PRINT"The meaning of these numbers are:"
270 PRINT
275 PRINT:PRINT"R= the number of digits that are "
280 PRINT:PRINT"right and are in the right place."
285 PRINT:PRINT"W= the number of digits that are "
290 PRINT:PRINT"right but are in the wrong place."
295 PLOT1,26,"HIT THE SPACE BAR TO CONTINUE"
300 REPEAT
301 INKINT(RND(1)*7)+1
305 UNTILKEY$=" ":CLS:RETURN
```

- 90 checks to see if any digits of your guess are right but in wrong place.
- 100 prints out the result of your guess.
- 105 jumps to the win routine if your guess is correct.
- 125 jumps to the routine for losing.
- 130 changes foreground colour to magenta, makes a noise and clears the screen.
- 135-155 prints the win instructions.
- 160-165 repeats the function of changing the foreground colour until the space bar is pressed.
- 170 makes a noise three times, pauses for one second.
- 175-190 prints lose instructions.
- 200 makes a noise.
- 205 changes foreground colour to green.
- 210-235 prints the instructions.
- 240-245 repeats changing foreground colour until the space bar is hit.
- 250-295 prints second page of instructions.
- 300-305 repeats the changing the foreground colour until the space bar is hit then returns.

Variables Used

- Z the number of goes taken.
- R number of numbers right and right place.
- W number of numbers right but wrong place.
- V\$ + V number of goes required.
- N(C) holding the code.
- M(C) the same as N(C).
- G(C) holding your guess.
- D for/next loop.
- X for/next loop.

These are some of the strange codes and words present in Oric BASIC which have cropped in this program:

- SPC(n) number of spaces (n) from cursor.
- CHR\$(20) cursor off.
- CHR\$(131) foreground colour yellow.
- CHR\$(140) flashing.
- CHR\$(129) foreground colour red.
- CHR\$(130) foreground colour green.

PING, MUSIC control the programmable sound generator.
GET, KEY\$ are keyboard entry functions.
WAIT is a pause statement.
PAPER, INK control the background and foreground colours.

MASTERMIND trade made and copyright owned by Invicta Plastics Limited, Oadby, Leicester.

Little Genius Ltd - exclusive licensees for COMPUTER MASTERMIND. Watch out for the official Little Genius MASTERMIND in all the major multiples from March - only £7.95.



Alien

Runs on
Spectrum

Alien Showdown

Play at cowboys in space with this great guns game to play on a Spectrum or any other machine come to think of it.

It's you or the alien enemy who must fight for survival in this galactic gun-down for two players to get to grips with. Each player has three lives to tussle with and each operate one space cowboy positioned on either side of the screen. You can both move your spaceman up and down the screen, aiming your gun-slinging arm at the enemy and avoiding his deadly shots.

If you manage to shoot down the enemy space cowboy a rocket flies past and you'll know for sure if you have only one life to play because the screen will suddenly start flashing violently.

When I wrote this game I found the main problem was to maintain a smooth flow of on-screen action. So I had to make sure the spaceman, rocket and firing was programmed on a pixel by pixel basis. To make the action happen quickly I had to use machine code instead of BASIC.

Control your space cowboys by using the following keys:

Player A: (left hand side).

Any key in ROW 1 to 5 will fire.

Any key from Q to T moves UP.

Any key from A to G moves DOWN.

Player B: (right hand side).

Any key in ROW 6 to 0 to fire.

Any key from Y to P moves up.

Any key from M to ENTER to move down.

The program is entered in three parts; the machine code, the graphics and the BASIC.

Enter Program One first of all. This is the machine code program and save both Program One and the machine code. After checking to RUN the machine code type PRINT USR 31000. If it does not work, re-check that you have keyed in Program One correctly.

Now enter Program Two, which contains the graphics of the game. Save both the graphics and program if you wish. You could try making your own graphics to suit your own particular tastes, in which case look at the section I've launched here under Conversion Clues.

RUNdown

Notes in the assembly listing show how the machine code runs. It is fairly simple:

The main routine reads the keyboard, calling the routines as required. It also detects whether the player has run out of lives, or whether or not the rocket should be moved. The most important

note is the ROM routine, called at 8874. B is loaded with the Y co-ordinate, C with the X co-ordinate and the routine called. The result is that HL contains the screen address, and the accumulator (A) with the number of the bit (0-7) corresponding to the pixel. For those who are interested in games programming if B is loaded with Y co-ordinate and 8933 called the point is plotted and the HL register contains the address of the ATTRIBUTE and DE is the value of the attribute.

Program 1. This POKES the machine code into the correct memory locations. Program 2. Sets up the graphics by the same method as program one.

Program 3. Line 10 loads the machine code and graphics.

Lines 20-50 Instructions and input. The speed of the phaser is determined by the length of the sound, the length of the sound is the value POKED to

31516.

Line 100 and the subroutine at 200 creates the alien type scenery, in random blocks with random characters.

110 calls the machine code.

120-130 detects to see who has won 140 gives you the option of having another go.

9999 save routine.

Conversion Clues

This program is written specifically for the Spectrum. The use of machine code makes it difficult to convert, but the assembly listing should help.

Alien Showdown was written on the 16K Spectrum but it also works on the 48K machine. If you wish to make up your own graphics remember that they must be upside down and on a 48K Spectrum you must POKE 23675,88 POKE 23676,127.

Also note that the highest and lowest lines of the graphics have to be 0 in order to blank out an old position.

```

10 CLEAR 30999
1000 FOR a=31000 TO 31267: READ q: POKE a,q: NEXT a
1010 DATA 33,100,0,34,20,91,33,88,127,34,10,91,33,136,127,34,16,91,33,184,127,34
1,18,91,33,0,0,34,4,91,33,247,0,34,6,91,33,3,3,24,8,91
1011 DATA 1,254,127,237,120,254,255,192,1,254,247,237,120,254,255,196,164,121,1,
254,251,237,120,254,255,196,199,121,1,254,253,237,120,254,255,196,8,122,1,254,23
9,237,120
1012 DATA 254,255,196,214,121,1,254,223,237,120,254,255,196,249,121,1,254,191,23
7,120,254,255,196,22,122,58,9,91,183,200,58,8,91,183,200,58,8,91,254,1,204,48
1013 DATA 122,58,9,91,254,1,204,48,122,24,160,0,0,237,75,4,91,205,120,122,35,35,
1,2,0,205,12,123,126,183,200,33,9,91,53,205,103,122,0,0,0,0,0,0,205,103,122,201,
205
1014 DATA 145,122,33,5,91,126,254,150,200,52,205,46,123,201,237,75,6,91,205,120,
122,0,43,1,0,0,205,12,123,126,183,200,33,8,91,53,205,103,122
1015 DATA 0,0,0,0,0,0
1020 DATA 205,103,122,201,205,128,122,33,7,91,126,254,150,200,52,205,46,123,201,
205,145,122,33,5,91,126,183,200,53,205,46,123,201,205,128,122,33,7,91,126,183,20
0,53,205,46,123,201
1030 FOR a=31280 TO 31593: READ q: POKE a,q: NEXT a
1035 DATA 33,21,91,126,254,150,40,21,52,237,75,20,91,237,67,12,91,237,75,18,91,2
37,67,14,91,205,46,123,201,1,113,123,237,67
1036 DATA 14,91,237,75,20,91,237,67,12,91,205,46,123,1,100,0,237,67,20,91,201,33
,0,64,1,160,23,126,238,255,119,35,11,120,177,32,246,201,120,198,12,71,205,170,34
,201,237,75,6,91,237,67,12,91,237,75,16,91,237,67,14,91,201,237,75,4,91,237
1037 DATA 67,12,91,237,75,10,91,237,67,14,91,201
1040 FOR a=31500 TO 31594: READ q: POKE a,q: NEXT a
1045 DATA 22,28,126,94,0,183,192,54,255,197,213,229,17,100,0,33,100,0,205,181,3,
225,209,193,54,0,9,43,21,122,183,32,225,201,237,75,12,91,237,67,22,91,30,2,22,24
,237,75,12,91,213,205
1046 DATA 170,34,209,237,75,14,91,10,119,3,237,67,14,91,33,13,91,52,21,122,183,3
2,227,58,23,91,50,13,91,58,22,91,198,8,50,12,91,29,123,183,32,206,201
9999 SAVE "M/C LOADER": SAVE "M/C CODE 31000,600"

```

```

10 FOR a=32600 TO 32767
20 READ q: IF PEEK a<>q THEN PRINT a,PEEK a: "i q
30 NEXT a
50 DATA 0,23,28,28,28,28,28,28
51 DATA 31,31,31,31,31,31,31,7
52 DATA 7,31,31,31,31,127,63,0
53 DATA 0,188,224,224,224,224,224,224
54 DATA 192,192,192,200,220,255,248,224
55 DATA 192,248,248,248,240,252,248,0
56 DATA 0,31,31,3,3,3,7,3
57 DATA 3,3,3,15,63,31,3
58 DATA 1,7,7,15,7,15,15,0
59 DATA 0,224,224,96,96,96,224,96
60 DATA 224,224,224,224,224,224,224,192
61 DATA 192,240,248,248,248,248,240,0
62 DATA 0,243,255,255,255,255,255,143
63 DATA 15,15,15,15,15,15,15,15
64 DATA 15,15,15,15,15,7,3,1
65 DATA 0,207,255,255,255,255,255,241
66 DATA 240,240,240,240,240,240,240
67 DATA 240,240,240,240,240,240,224,192
68 DATA 128,24,60,126,255,255,126,8,24
69 DATA 0,0,0,34,34,62,126,255
70 DATA 25,25,127,254,254,126,24,16
80 SAVE "M/C LOADER": SAVE "M/C CODE 32600,168
10 CLEAR 30999: LOAD "M/C CODE 31000": LOAD "M/C CODE USR "a"
200 PAPER 0: BORDER 0: INK 6: PRINT FLASH 1:"ALIEN SHOWDOWN""STOP THE TAPE""
Press any key to continue": PAUSE 0: CLS
30 PRINT "INSTRUCTIONS""The idea of the game is to shoot the opponent ""You
can withstand three"" phaser blasts before you die""CONTROLS""Person A USE""
ROW 1 TO 5 TO FIRE""ROW 0 TO T TO MOVE UP""ROW A TO G TO MOVE DOWN""
40 PRINT "Person B USE""ROW 6 TO 0 TO FIRE""ROW P TO Y TO MOVE UP""ROW ENT
ER TO G TO MOVE DOWN""Person A is on the <LEFT>""Press any key to continue":
PAUSE 0: CLS
50 INPUT "What is person A's Name":a$: INPUT "What is person B's Name":b$: IN
PUT "Speed of Phaser fire (1 fastest 255 slowest)":e: POKE 31516,e
60 PRINT "Press any key to start AND may the best thing win": PAUSE 0: CLS
100 FOR a=0 TO 20: LET x=RND*18: LET y=RND*26+2: INK RND*3+3: GO SUB 200: NEXT
a: INK 7
110 RANDOMIZE USR 31000
120 IF PEEK 23304=0 THEN PRINT b$:" HAS WON"
130 IF PEEK 23305=0 THEN PRINT a$:" HAS WON"
140 INPUT "ANOTHER GO (y/n)":i$: IF q#="y" OR q#="Y" THEN GO TO 30
150 STOP
200 FOR a=0 TO 5: PRINT AT x:RND*3,y:RND*3:CHR# ((RND*2)+162): NEXT s: RETURN
9999 SAVE "A.SHOWDOWN" LINE 1: SAVE "M/C CODE 31000,600": SAVE "M/C CODE 32600,16
8

```

PROGRAM

SUBMISSIONS



Do You Want Fame and Fortune?

Does brilliance reside in your RAM? Do your friends gasp at your own programs with envy in their eyes? Would you like to see your name in *Games Computing*!

If you have written a program to take the software world by storm and want to show your fellow readers just what you can do on a keyboard, cut out or photocopy the form below and send it to the Editor, Games Computing, (clearly marked PROGRAM SUBMISSIONS) at 145 Charing Cross Road, London WC2H 0EE (until 16 December 1983) and after that to 1 Golden Square, London W1.

Please send with your tape recording of the program a thorough explanation of the game, a line by line listing of how the program works along with a list of relevant variables etc. Also include any clues which you can think of to help owners of other computers other than the one which the program was written for, convert it for use on their computer.

We will look at games programs on tape for all the popular home micros and disc versions for the Commodore machines, Atari and BBC (40 track and Hitachi format). Whenever possible use CHR\$ rather than command codes and please avoid making programs autorun. If you can let us have a printout of the program it helps and the same goes for screen dumps.

P.S. They'll be paid for too!

★ PLEASE COMPLETE IN BLOCK CAPITALS

Your Name	Age
Program Name	
Computer/memory size it runs on	
Amount of memory program occupies	
Other computers/memory size which your program runs on	
Does your game need joysticks?	Yes No
Any known bugs? If so, what are they?	
Have you sent your game to another magazine	Yes No
Is it original/or a variation on a theme?	
Your Address	
Telephone Number	
Times to contact you	

```

1 POKE 54018,52:REM PUT IN MUSIC TAPE ON
CE PROG LOADED
2 POKE 752,1
4 GRAPHICS 3:GOSUB 500:REM TITLE BLOCK
5 PRINT :PRINT "          SIMPLE SIMON
   ":PRINT "          S.M.HILLEN"
6 GOSUB 542
7 FOR Y=1 TO 200
8 NEXT Y
9 GRAPHICS 0:REM INSTRUCTIONS TO PLAY
10 PRINT "THIS IS THE GAME CALLED
   SIMPLE SIMON "
15 PRINT :PRINT
20 PRINT "TO PLAY THE GAME : "
25 PRINT :PRINT
30 PRINT "      YOU MOVE THE TRIGGER UP F
OR
HANDS IN THE AIR"
35 PRINT "      YOU MOVE THE TRIGGER LEFT
FOR
HANDS ON HEAD"
40 PRINT "      YOU MOVE THE TRIGGER RIGH
T FOR
HANDS ON SHOULDERS"
45 PRINT "      YOU MOVE THE TRIGGER DOWN
FOR
HANDS ON KNEES"
50 PRINT :PRINT
55 PRINT "ONLY DO THIS WHEN SIMON TELLS
YOU"
60 PRINT "          ----- "
70 PRINT "PRESS THE BUTTON WHEN IT'S YOU
R NAME"
72 PRINT "          ---
--"
75 PRINT "TO START PRESS RETURN"
80 DIM A$(255):INPUT A$:IF A#="255" THEN
85
85 GRAPHICS 3:GOSUB 5000:REM ASKS FOR PL
AYERS NAME
90 PRINT :PRINT "WHAT IS YOUR FIRST NAME
":DIM B$(12):INPUT B$:DIM C$(5):C#="SIMO
N":DIM Z$(12)
91 PRINT :PRINT :PRINT "GOOD LUCK " ; B#
92 GOSUB 542
95 Z3=Z3+1:IF Z3=6 THEN 450:REM NUMBER O
F GOES
96 GRAPHICS 3
110 GOSUB 500
150 POKE 752,1
160 GOSUB 1000:REM RANDOM NO. FOR X&Y
170 IF Y=1 THEN Z#=B$:REM PLAYERS NAME I
S SHOWN
175 IF Y=2 THEN Z#=C$:REM SIMONS NAME SH
OWN
200 IF X=1 THEN PRINT :PRINT Z#;" SAYS H
ANDS IN THE AIR"
210 IF X=2 THEN PRINT :PRINT Z#;" SAYS H
ANDS ON HEAD"
220 IF X=3 THEN PRINT :PRINT Z#;" SAYS H
ANDS ON SHOULDERS"
230 IF X=4 THEN PRINT :PRINT Z#;" SAYS H
ANDS ON KNEES"
250 IF STICK(0)=0 THEN 250
255 IF STICK(0)=15 THEN 255
260 IF STICK(0)=14 THEN 1200:REM HANDS I
N THE AIR
265 IF STICK(0)=11 THEN 1300:REM HANDS O
N HEAD
270 IF STICK(0)=7 THEN 1400:REM HANDS ON
SHOULDERS
275 IF STICK(0)=13 THEN 1500:REM HANDS O
N KNEES
280 REM 290 TO 350 GAME LOGIC CHECKS COM
MAND WITH RESPONSE
290 IF X=1 AND STICK(0)=14 THEN 360
295 IF X=2 AND STICK(0)=11 THEN 360
300 IF X=3 AND STICK(0)=7 THEN 360

```



Simon Says...

'Simple Simon' uses an ATARI 400 Computer, a 'BASIC' cartridge and a controller. I developed the program as a fund raiser for school fêtes etc. The instructions are in the program. The idea behind the game is to place Simon's hands on his head, shoulders, knees and in the air by using the stick of the controller. The player enters his name and the game begins. If the player's name appears instead of Simon's then the player must hold

down the red button on the controller before moving the stick to the position required.

There is some interesting animation, a dog, a lamp post, as well as Simon. The program can be run with a suitable music tape to add interest and to put the contestant off.

The listing follows (the REM instructions need not be typed and are there to explain the program workings.).

**Runs on
Atari**

```
310 IF X=4 AND STICK(0)=13 THEN 360
320 IF X>1 AND STICK(0)=14 THEN 400
330 IF X<2 OR X>2 AND STICK(0)=11 THEN 400
340 IF X<3 OR X>3 AND STICK(0)=7 THEN 400
350 IF X<4 OR X>4 AND STICK(0)=13 THEN 400
360 GOSUB 2000:REM COUNTER RIGHT
370 END
400 GOSUB 3000:REM COUNTER WRONG
445 REM 450 TO 490 WINNING PRESENTATION
450 PRINT :PRINT :PRINT " SIMON SAYS W
WELLDONE
YOU HAVE BEATEN ME"
460 GOSUB 7000
470 GRAPHICS 2:PRINT #6;"WELLDONE":POSIT
ION 0,6:PRINT #6;"HAVE ANOTHER GO!"
475 POSITION 6,3:PRINT #6,B#
485 PRINT "PRESS RETURN TO GO AGAIN",:DI
" A3#(255):INPUT A3#:IF A3#="255" THEN 4
70
490 Z=0:S=0:R=0:GOTO 95
500 COLOR 1:REM MAN
510 PLOT 18,1:DRAWTO 22,1:PLOT 18,1:DRAW
TO 18,4:PLOT 17,2:PLOT 22,1:DRAWTO 22,4:
PLOT 23,2:PLOT 19,5:DRAWTO 21,5
520 PLOT 17,7:DRAWTO 17,11:PLOT 18,7:PLO
T 19,7:DRAWTO 19,12:DRAWTO 17,14:DRAWTO
17,16:PLOT 16,16
525 PLOT 20,6:DRAWTO 20,11
530 PLOT 21,7:DRAWTO 21,12:DRAWTO 23,14:
DRAWTO 23,16:PLOT 24,16:PLOT 18,7:PLOT 2
2,7:PLOT 23,7:DRAWTO 23,11
532 COLOR 2:PLOT 19,2:PLOT 21,2:COLOR 3:
PLOT 20,3:COLOR 2:PLOT 19,4:DRAWTO 21,4
533 REM DOG
```

```

534 COLOR 3:PLOT 6,13:PLOT 7,14:DRAWTO 7
,16:PLOT 8,14:DRAWTO 11,14:PLOT 12,13:PL
OT 12,11:PLOT 13,12
536 PLOT 11,15:DRAWTO 11,16
538 COLOR 1:PLOT 30,1:DRAWTO 30,16:PLOT
29,3:DRAWTO 31,3:COLOR 2:PLOT 29,4:PLOT
31,4:PLOT 29,2:PLOT 31,2
539 COLOR 1:PLOT 29,1:PLOT 31,1:PLOT 29,
5:PLOT 31,5:PLOT 1,17:DRAWTO 39,17
540 RETURN
542 FOR Y2=1 TO 90:REM MAN SPEAKS DOG WA
GS TAIL
545 COLOR 0:PLOT 6,13:COLOR 3:PLOT 7,13:
COLOR 0:PLOT 7,13:COLOR 3:PLOT 6,13
546 COLOR 0:PLOT 19,4:DRAWTO 21,4:COLOR
3:PLOT 19,4:DRAWTO 21,4
547 NEXT Y2
550 RETURN
700 PRINT "YOU ARE OUT"
710 END
1000 X=0:X=INT((RND(4)*10)+0.5)
1005 IF X>4 THEN 1000
1007 IF X<1 THEN 1000
1010 Y=0:Y=INT((RND(4)*10)+0.5)
1015 IF Y>2 THEN 1010
1017 IF Y<1 THEN 1010
1020 RETURN
1200 REM HANDS IN AIR
1210 PLOT 16,6:DRAWTO 13,3:PLOT 13,2:PLO
T 24,6:DRAWTO 27,3:PLOT 27,2
1220 COLOR 0:PLOT 17,8:DRAWTO 17,11:PLOT
23,8:DRAWTO 23,11
1230 GOTO 290
1300 REM HANDS ON HEAD
1310 PLOT 24,6:PLOT 25,5:DRAWTO 23,3:PLO
T 16,6:PLOT 15,5:DRAWTO 17,3
1320 COLOR 0:PLOT 17,8:DRAWTO 17,11:PLOT
23,8:DRAWTO 23,11
1330 GOTO 290
1400 REM HANDS ON SHOULDERS
1410 PLOT 16,7:PLOT 15,7:DRAWTO 15,5:DRA
WTO 17,5:PLOT 17,6:PLOT 24,7:PLOT 25,7:D
RAWTO 25,5:DRAWTO 23,5:PLOT 23,6
1420 COLOR 0:PLOT 17,8:DRAWTO 17,11:PLOT
23,8:DRAWTO 23,11
1430 GOTO 300
1500 REM HANDS ON KNEES
1510 COLOR 0:PLOT 17,7:DRAWTO 17,12:PLOT
23,7:DRAWTO 23,12
1520 COLOR 1:PLOT 17,8:DRAWTO 15,10:DRAW
TO 17,12:PLOT 23,8:DRAWTO 25,10:DRAWTO 2
3,12
1530 GOTO 310
2000 REM COUNTER
2002 IF Y=1 AND STRIG(0)=1 THEN 3000
2003 IF Y=2 AND STRIG(0)=0 THEN 3035
2005 R=R+1
2010 GOSUB 542
2040 GOTO 95
3000 REM COUNTER
3010 IF Y=2 AND STRIG(0)=0 THEN 3035
3020 IF Y=1 AND STRIG(0)=1 THEN 3035
3030 IF Y=2 AND STRIG(0)=1 THEN 3035
3035 GRAPHICS 2:S=S+1
3040 POSITION 1,1:PRINT #6;"YOU
ARE OUT!!!!!!
!! ";B#
3045 POSITION 1,6:PRINT #6;"YOUR SCORE
WRONG=";S:POSITION 2,8:PRINT #6
;"RIGHT=";R
3048 PRINT :PRINT " TRY AGAIN ";B
#;"!"
3050 FOR Q9=1 TO 500
3055 NEXT Q9
3060 GOSUB 6000

```



```

3065 RUN
5000 GRAPHICS 3:COLOR 2:REM MAN SALUTES
5005 PLOT 18,1:DRAWTO 22,1:PLOT 18,1:DRA
WTO 18,4:PLOT 17,2:PLOT 22,1:DRAWTO 22,4
:PLOT 23,2:PLOT 19,5:DRAWTO 21,5
5010 PLOT 17,7:DRAWTO 17,11:PLOT 18,7:PL
OT 19,7:DRAWTO 19,12:DRAWTO 17,14:DRAWTO
17,16:PLOT 16,16
5015 PLOT 20,6:DRAWTO 20,11
5020 PLOT 21,7:DRAWTO 21,12:DRAWTO 23,14
:DRAWTO 23,16:PLOT 24,16:PLOT 18,7:PLOT
22,7:PLOT 23,7:DRAWTO 23,11
5025 COLOR 2:PLOT 19,2:PLOT 21,2:COLOR 3
:PLOT 20,3:COLOR 2:PLOT 19,4:DRAWTO 21,4
5030 COLOR 1:PLOT 30,1:DRAWTO 30,16:PLOT
29,3:DRAWTO 31,3:COLOR 2:PLOT 29,4:PLOT
31,4:PLOT 29,2:PLOT 31,2
5038 COLOR 3:PLOT 6,13:PLOT 7,14:DRAWTO
7,16:PLOT 8,14:DRAWTO 11,14:PLOT 12,13:P
LOT 12,11:PLOT 13,12
5039 PLOT 11,15:DRAWTO 11,16
5040 COLOR 1:PLOT 29,1:PLOT 31,1:PLOT 29
,5:PLOT 31,5:PLOT 1,17:DRAWTO 39,17:D=1
5042 FOR H3=1 TO 200
5043 NEXT H3
5045 COLOR 0:PLOT 17,11:DRAWTO 17,8
5050 COLOR 2:PLOT 17,6:DRAWTO 15,4:DRANT
0 18,1
5060 RETURN
6000 GRAPHICS 3:COLOR 2:REM MAN . DOG WA
LKS TO LAMP POST AND LIFTS LEG AND WAGS
TAIL
6001 IF Z3=11 THEN 6005
6002 PRINT :PRINT " SIMON HAS WON NE
XT 60 PLEASE "
6005 PLOT 18,1:DRAWTO 22,1:PLOT 18,1:DRA

```

mon Says..



```
WTO 18,4:PLOT 17,2:PLOT 22,1:DRAWTO 22,4
:PLOT 23,2:PLOT 19,5:DRAWTO 21,5
6010 PLOT 17,7:DRAWTO 17,11:PLOT 18,7:PL
OT 19,7:DRAWTO 19,12:DRAWTO 17,14:DRAWTO
17,16:PLOT 16,16
6015 PLOT 20,6:DRAWTO 20,11
6020 PLOT 21,7:DRAWTO 21,12:DRAWTO 23,14
:DRAWTO 23,16:PLOT 24,16:PLOT 18,7:PLOT
22,7:PLOT 23,7:DRAWTO 23,11
6025 COLOR 2:PLOT 19,2:PLOT 21,2:COLOR 3
:PLOT 20,3:COLOR 2:PLOT 19,4:DRAWTO 21,4
6030 COLOR 1:PLOT 30,1:DRAWTO 30,16:PLOT
29,3:DRAWTO 31,3:COLOR 2:PLOT 29,4:PLOT
31,4:PLOT 29,2:PLOT 31,2
6040 COLOR 1:PLOT 29,1:PLOT 31,1:PLOT 29
,5:PLOT 31,5:PLOT 1,17:DRAWTO 39,17:D=1
6045 COLOR 3:D=D+1:FOR J=1 TO 10
6050 PLOT 6+D,13:PLOT 7+D,14:DRAWTO 7+D,
16:PLOT 8+D,14:DRAWTO 11+D,14:PLOT 12+D,
13:PLOT 12+D,11:PLOT 13+D,12
6055 PLOT 11+D,15:DRAWTO 11+D,16
6057 NEXT J
6058 IF D>=21 THEN 6100
6059 IF D<21 THEN 6060
6060 COLOR 0:PLOT 11+D,15:DRAWTO 11+D,16
6070 PLOT 6+D,13:PLOT 7+D,14:DRAWTO 7+D,
16:PLOT 8+D,14:DRAWTO 11+D,14:PLOT 12+D,
13:PLOT 12+D,11:PLOT 13+D,12
6072 COLOR 1:PLOT 30,16:DRAWTO 30,10
6073 COLOR 2:PLOT 19,11:PLOT 19,12:DRAWTO
0 17,14:DRAWTO 17,16:PLOT 16,16
6074 COLOR 2:PLOT 20,11:DRAWTO 21,11:DR
AWTO 21,12:DRAWTO 23,14:DRAWTO 23,16:PLOT
24,16
6075 GOTO 6045
6100 COLOR 0:PLOT 7+D,13:DRAWTO 7+D,16
6105 FOR J1=1 TO 30
6110 COLOR 3:PLOT 7+D,13:DRAWTO 7+D,10
6115 NEXT J1
6120 COLOR 0:PLOT 7+D,13:DRAWTO 7+D,10
6125 COLOR 3:PLOT 7+D,13:DRAWTO 7+D,16
6130 FOR W9=1 TO 100
6135 COLOR 0:PLOT 28,13:PLOT 27,13:COLOR
3:PLOT 28,13:COLOR 0:PLOT 28,13:COLOR 3
```

```
:PLOT 27,13:NEXT W9
6140 RETURN
7000 FOR Y6=1 TO 2:REM MAN CHEERS DOG WA
GS TAIL
7002 COLOR 0:PLOT 17,8:DRAWTO 15,10:DR
AWTO 17,12:PLOT 23,8:DRAWTO 25,10:DRAWTO 2
3,12
7005 COLOR 0:PLOT 17,8:DRAWTO 17,11:PLOT
23,8:DRAWTO 23,11
7006 COLOR 0:PLOT 18,4:PLOT 24,4
7007 FOR Y3=1 TO 20
7008 COLOR 0:PLOT 6,13:COLOR 2:PLOT 7,13
:COLOR 0:PLOT 7,13:COLOR 2:PLOT 6,13
7009 COLOR 1
7010 PLOT 16,6:DRAWTO 13,3:PLOT 13,2:PL
O T 24,6:DRAWTO 27,3:PLOT 27,2
7011 COLOR 0:PLOT 19,4:DRAWTO 21,4:COLOR
2:PLOT 19,4:DRAWTO 21,4
7014 NEXT Y3
7015 COLOR 0
7020 PLOT 16,6:DRAWTO 13,3:PLOT 13,2:PL
O T 24,6:DRAWTO 27,3:PLOT 27,2
7025 COLOR 1
7027 FOR Y4=1 TO 20
7028 COLOR 0:PLOT 6,13:COLOR 3:PLOT 7,13
:COLOR 0:PLOT 7,13:COLOR 3:PLOT 6,13
7029 COLOR 1
7030 PLOT 16,7:PLOT 15,7:DRAWTO 15,5:DR
AWTO 17,5:PLOT 17,6:PLOT 24,7:PLOT 25,7:D
RAWTO 25,5:DRAWTO 23,5:PLOT 23,6
7031 COLOR 0:PLOT 19,4:DRAWTO 21,4:COLOR
2:PLOT 19,4:DRAWTO 21,4
7034 NEXT Y4
7035 COLOR 0
7040 PLOT 16,7:PLOT 15,7:DRAWTO 15,5:DR
AWTO 17,5:PLOT 17,6:PLOT 24,7:PLOT 25,7:D
RAWTO 25,5:DRAWTO 23,5:PLOT 23,6
7045 NEXT Y6
7050 COLOR 1
7055 PLOT 16,7:PLOT 15,7:DRAWTO 15,5:DR
AWTO 17,5:PLOT 17,6:PLOT 24,7:PLOT 25,7:D
RAWTO 25,5:DRAWTO 23,5:PLOT 23,6
7060 RETURN
```



Towers of Brāhṃa

A scintillating puzzle to stretch the brain cells takes the form of Towers of Brahma. The object of the program is to solve a puzzle set by a Hindu diety, Brahma, in the shortest number of moves and the quickest possible time.

The puzzle involves three towers labelled A,B, and C and also a certain number of rings, with each ring having a certain weight. To solve the puzzle the rings which are placed on tower A by the computer have to be transferred to tower C. But this is not as easy as you think because a ring which has a larger weight cannot be put on a ring which has a smaller weight. The computer will give you a choice of the number of rings you wish to transfer. The greater number of rings you pick the harder the puzzle becomes. After the puzzle has been solved, the computer prints out how many moves it took the user to solve it and how much time. Then it will ask the user if he would like to replay to beat his previous time. A ring is presented

by a number and that number is its weight. No ring is represented by the number 0. This program also includes sound.

RUNdown

Line	Action
10-220	are the instructions.
240	inputs the number of rings.
260	sets the clock to 0 and makes an array for the towers and rings.
270	prints the towers and the rings.
290-320	inputs from which tower is the ring going to be moved.
350-380	inputs to which tower the ring is going to be moved.
390-420	checks for an illegal move.
430	moves the ring.
500-889	are the ending routine.
900	is the sound routine.

Conversion clues

Conversion should not be difficult if the

computer has dim and data commands. The only two problems are: the cursor commands as shown in Fig. 1.

1 THE CURSOR COMMANDS:--

- CURSOR RIGHT
- ▣ CURSOR DOWN
- CURSOR CLEAR SCREEN
- ▢ CURSOR UP
- ▣ CURSOR PRINT IN REVERSE MODE

And the POKE (sound) positions. These should only be entered if the computer has sound. 'POKE 36878,15' sets the volume and 'POKE 36876,200' sets the pitch. If the computer does not have sound type in for line 900 and line 30:

```
900 Return
30 Next
```

THE TOWERS OF BRAHMA

```

5 REM**BY N.M.JAYAKUMAR (C)1983**
10 PRINT"□":FORA=1TO42:PRINT:FORB=1TO99:NEXT:IFA=19THENPRINT"          PRESENTS"
20 IFA=17THENPRINT"  NAGARAJ JAYAKUMAR"
30 NEXT:POKE36878,15
50 FORA=1TO19:PRINT:FORB=1TO99:NEXT:IFA=4THENPRINT"          T H E"
60 IFA=8THENPRINT"  T O W E R S"
70 IFA=12THENPRINT"    O F"
80 IFA=16THENPRINT"B  R  A  H  M  A"
90 NEXT
100 FORA=1TO1000:NEXT:FORA=1TO109:READA#:PRINTA#::FORB=1TO200:NEXT:NEXT
110 DATA"MM",A,N,Y,"Y",E,A,R,S,"A",G,O,"I",N,"■■■■■I",N,D,I,A,"T",H,E,R,E,
" L",I,V
120 DATAE,D,"A M H",I,N,D,U,"D",E,I,T,Y,"C",A,L,L,E,D,"  BRAHMA.H",E,"G"
,A,V,E
130 DATA" H",I,S,"  MD",I,S,C,I,P,L,E,S,"A D",I,F,F,I,C,U,L,T,"■■■",R,O,B,L,E
,M," W"
140 DATAH,I,C,H,"Y",O,U,"A",R,E,"M A",B,O,U,T,"T",O,"T",R,Y,"A",N,D,"  M
S",O,L
150 DATAV,E,"":FORA=1TO506:PRINT" ":NEXT:PRINT
160 PRINT"WHAT YOU HAVE TO DO IS TRANSFER RINGS FROM AM TOWER INTO ANOTHER M T
OWER."
170 PRINT"MTHERE ARE 3 TOWERS:- M A,B,C. THE RINGS HAVEM TO BE TRANSFERED FROMM"
180 PRINT" TOWER A TO TOWER C"
190 PRINT"MPRESS A KEY":V=-1
200 GETA#:IFA#=""THEN200
210 GOSUB900:PRINT"MEACH RING HAS A NUMBERM AND YOU CANNOT PLACE AMLARGER RING
ON A M"
220 PRINT"SMALLER RING.          MPRESS A KEY"
230 GETA#:IFA#=""THEN230
240 GOSUB900:CLR:PRINT"MHOW MANY RINGS WOULD M YOU LIKE(5-9)":INPUTA:GOSUB900
250 IFA<5OR A>9THEN240
260 TI#="000000":DIMB(3,A+1):FORC=1TOA:B(1,C)=C:NEXT
270 V=V+1:PRINT"□":FORH=1TOA:GOSUB900:PRINT"  ":B(1,H):"  ":B(2,H):"  ":B(3,
H):NEXT
280 PRINT" M  A      B      C":PRINT" M-----"
285 FORP=1TOA:IFB(3,P)<>0THEN290
287 NEXT:GOTO500
290 PRINT"FROM WHICH TOWER IS  THE RING TO MOVE?"
300 GETA#:IFA#=""THEN300
310 GOSUB900:Z=ASC(A#):IFZ=65ORZ=66ORZ=67 THENGOTO330
320 PRINT"IT":GOTO290
330 Z=Z-64:FORY=1TOA:IFB(Z,Y)<>0THEN350
340 NEXT:PRINT"ITHERE ARE NO RINGS IN TOWER "A#"          ":FORT=1TO5000:NEXT
:GOTO270
350 PRINT"ITTO WHICH TOWER HAS  THE RING TO GO?          "
360 GETB#:IFB#=""THEN360
370 GOSUB900:X=ASC(B#):IFX=65ORX=66ORX=67THEN390
380 PRINT"□":GOTO350
390 X=X-64:FORW=1TOA:IFB(X,W)<>0THEN405
400 NEXT
405 IFZ=XTHENGOTO270
410 IFB(X,W)<B(Z,Y)ANDB(X,W)<>0ANDW<A+1THENPRINT"ITTHE RING IS TOO LARGE TO GO
ON TOWER "B#
420 IFB(X,W)<B(Z,Y)ANDB(X,W)<>0ANDW<A+1THENFORT=1TO2500:NEXT:GOTO270
430 B(X,W-1)=B(Z,Y):B(Z,Y)=0
440 GOTO270
500 FORQ=1TO50:PRINT"□CONGRATULATIONS":NEXT
510 PRINT"MYOUR TIME IS "TI#"  SECONDS":PRINT"MYOU TOOK"V"MOVES."
520 FORT=1TO5000:NEXT
600 PRINT"MYOUR TRY AGAIN TO BETTER  YOUR TIME":INPUTA#
610 IFA#="YES"THENRUN240
620 IFA#="NO"THEN899
630 PRINT"MI DO NOT UNDERSTAND  USE (YES OR NO)":GOTO600
899 END
900 POKE36876,200:FORR=1TO200:NEXT:POKE36876,0:RETURN

```

SOLITAIRE

Runs on Atom

```
>L
10CLEAR0,S=48,?#E1=0,@=1,DIMBB150,GG3,RR1,P-1
30A=0,B=0,P $21,[, RRO JSR #FFE3,STA #80,RTS,]
35[, RR1 JSR #FE71,STY #81,RTS,]P $6,G 5000
40CLEAR0,GOS a,?#E1=0,L=0,M=-1
100P $30,?#E0=22,P "MOVE";F B=0TO7;B?#8055=64;N ;P $10
105?#E0=22;P " " ;?#E0=27;P " " ;?#E0=20,P "PEGS"
106P " LEFT " , $8, $8, S, LINK RRO;M=M+1,IFI=0,IF?#80=90 G z
108IF?#80=76 G 1
110GG(0)=?#80-49,IFGG(0)<0ORGG(0)>7G 100
120?#8055=?#80
125LINK RRO;GG(1)=?#80-65;IFGG(1)<0ORGG(1)>7G 125
130?#8056=?#80-64
133?#8058=20,?#8059=15
135LINK RRO;GG(2)=?#80-49;IFGG(2)<0ORGG(2)>7G 135
140?#805B=?#80
145LINK RRO;GG(3)=?#80-65;IFGG(3)<0ORGG(3)>7G 145
150?#805C=?#80-64
160E=#8022+(GG(1)*32)+(GG(0)*2);F=#8022+(GG(3)*32)+(GG(2)*2)
172P $10,$8,$8,$8,$8,$8,H=((F-E)/2)+E;IF?H=#2E G b;REM
175IF?F=#4F;G b
176IF?E=#2E;G b
190IFF-E=4;E?2=#2E;G c
200IFE-F=4;E?-2=#2E;G c
210IFF-E=#40;E?32=#2E;G c
220IFE-F=#40;E?-32=#2E;G c
225G b
230c?E=#2E;?F=#4F;S=S-1,I=0
240BB(L)=E;L=L+1;BB(L)=F;L=L+1;BB(L)=H;L=L+1;G 100
600z?E=#4F;?F=#2E;?H=#4F;F A=0TO20;P $30,$10;?#E0=20;I=1
605P "CANCELLED";WAIT,?#E0=20,P " " ;N ;S=S+1;L=L-3
606M=M-1;G 100
7901GOS a;F A=0TO64;A?#8180=64;N ;P $30;F A=0TO11;P $10;N
792P "KEY 1 TO REPLAY"" 2 TO QUIT"
793LINK RRO;IF?#80=49 G 800
794IF?#80=50;P $12,"GOODBYE";END
795G 793
800?#E0=0;P $11,"PRESS S TO STOP REPLAY"" "
8010=48
802F L=0TO3*(47-S)S 3 ;E=BB(L);F=BB(L+1);H=BB(L+2)
805P $30,$10,$10,$10,$10,$10,$10,$10;?#E0=30;P O;IFO<10 P " "
806F A=0TO50;LINK RR1;IF?#81=#33 G 816
810WAIT;N ;?E=#2E;?F=#4F;?H=#2E;O=O-1;N ;F A=0TO64;A?#8180=64
814N
816P $30;F A=0TO11;P $10;N ;P "KEY Z TO RE-ENTER MOVE"" "
817P "L TO QUIT";M=(L/3);S=48-M;G 100
1000aP $30;?#E1=0
1010P $9," 1 2 3 4 5 6 7 8""A""B""C""D""E""F""G""H"
1020F A=0TO14S 2;A?#8022=#4F;A?#8042=#4F;A?#80E2=#4F
1030A?#8102=#4F;N ;F A=0TO96S 32;A?#8062=#4F;A?#8064=#4F
1045A?#8066=46;A?#8068=46;A?#806A=46;A?#806C=46;A?#8070=#4F
1050A?#806E=#4F;N ;P $30;F A=0TO11;P $10;N
1070P "KEY Z TO RE-ENTER MOVE"" L TO QUIT OR REPLAY";R
1990bF A=0TO20;P $30,$10;I=1
2000?#E0=22;P "ILLEGAL";WAIT;?#E0=22;P " " ;N ;M=M-1;G 100
5000F A=-1TO62S 8;MOVEA,0;DRAWA,48;N ;F A=-1TO46S 4;MOVE0,A
5010DRAW64,A;N ;P $30"""";?#E0=6;P "SQUARE SOLITAIRE"
5050F A=0TO500;WAIT;N ;P $12;?#E1=0
5100P "PRESS 1 FOR INSTRUCTIONS"" " 2 TO START""
5110LINK RRO;IF?#80=50 G 40
5120IF?#80=49 G 5140
5130G 5100
5140P $12," THE OBJECT OF THIS GAME IS TO"" REMOVE AS "
5145?#E1=0
5150P "MANY PIECES AS"" POSSIBLE BY HORIZONTAL OR""
5155P " VERTICAL JUMPS. WHEN "
5170P "A PIECE IS JUMPED OVER IT IS TAKEN. YOUR TARGET "
5180P "IS TO BE LEFT WITH ONLY ONE PIECE ON THE BOARD. "
5190P "THE COMPUTER REJECTS ALL ILLEGAL MOVES !""
5200P "PIECES ARE MOVED BY INPUTTING"" THEIR CO-ORDINATES""
5210 P "PRESS ANY KEY FOR DEMONSTRATION OF CO-ORDINATES"
5220 LINK RRO;CLEAR0;?#E1=0;GOS a;?#8048=24;?#8088=25;P $30,$10
5240?#E0=20;P "TO MOVE FROM",$10;?#E0=22;P "X TO Y",$10
5250?#E0=24;P "INPUT",$10;?#E0=22;P "4 B 4 D",$10;?#E0=20
5260P "(4B=X 4D=Y)"" " "ALWAYS INPUT THE NUMBER BEFORE THE "
5270P "LETTER."" " "DIAGONAL & ILLEGAL MOVES ARE""REJECTED. PRE"
5290P "SS ANY KEY TO START THE GAME.";LINK RRO;G 40
```

Square Solitaire (needs 5K text 1K graphics)

The object is of Square Solitaire to remove as many pieces as possible from the grid by jumping over them with another piece.

Pieces can only be moved horizontally or vertically and must jump over another piece and land in an empty square. Illegal moves are prompted ILEGAL and are ignored.

Pieces are moved by entering the coordinates to and from as explained at the start of the program. If key Z is pressed the last move played will be ignored and the pieces are re-instated in their previous positions. If key L is pressed the game is replayed and can be stopped at any point by pressing S, you can then continue to play from that point.

EXPLORE NEW FRONTIERS OF FUN WITH *Audiogenic*

From vintage classics like "AMOK" and "ALIENBLITZ" to the latest classics like "KAKTUS" and "MOTOR MANIA".

From Machine Code Arcade Action through Graphical Adventure to Mind Bending Board Games - WE'VE GOT THE LOT!

THE BIGGEST RANGE EVER FOR VIC 20 and 64 - NOW ALSO DRAGON AND SPECTRUM
WRITE OR PHONE FOR FREE COLOUR CATALOGUE!

AUDIOGENIC, P.O. BOX 88, READING, BERKS. (0734) 586334



MORE THAN JUST A GAME...

MOGUL

THE HOTWARE PEOPLE

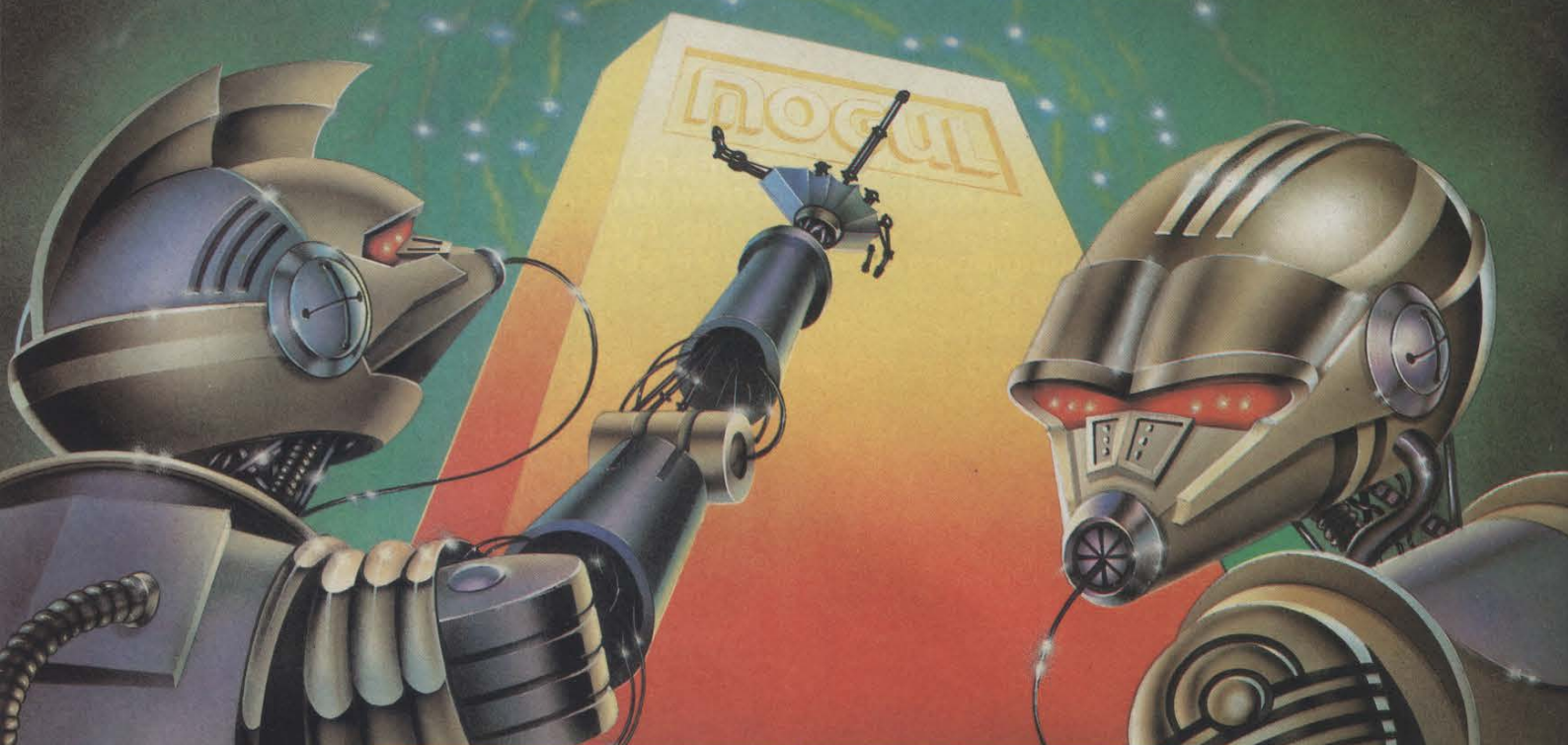

METAMORPHOSIS
You stumbled into the nest of the **Cyglorx** and find yourself fighting off robot tanks guarding the **Cyglorx** eggs. You think you have everything under control and then the eggs start **hatching**. Commodore 64 version features 4 different screens.
VIC 20 - COMMODORE 64
£7.95

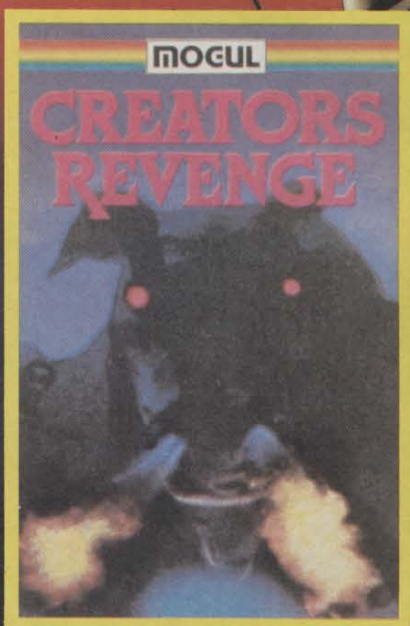

CREATOR'S REVENGE
The **creator** assembled a massive army of **robots** and **insects** to take revenge on the earth. Destroy **insects**, get **treasures**, and get the **neutron bomb deactivator**. Battle **robots** and **destroy** the **neutron bomb** before it annihilates your city. Miss and you must face the **mutants**. Features 4 different screens.
COMMODORE 64
£7.95

OTHER GAMES AVAILABLE



MOGUL COMMUNICATIONS LIMITED
90 Regent Street, London W1R 5PT Telephone 01-437 3156/7



1984



QUICKSILVA

...THE YEAR OF THE GAME LORDS.

fantasy

SOFTWARE

THE PYRAMID is an arcade style game which has a very adventurous feel to it.

The Pyramid contains 120 chambers on 15 levels. In order to get from one chamber to another you must fight off the indigenous aliens to collect an energised crystal which will neutralize the force field guarding the two exits.

The Pyramid is inhabited by a total of 60 wierd and exotic alien types, all of which are beautifully animated. You will meet a whole variety of demons, droids, insects and monsters, with a sprinkling of the more unusual, the extra-terrestrial tweezers, galactic strawberry, cosmic claw, mutant eye, plus a whole host of entities that defy rational description. You will no doubt invent your own nicknames.

You proceed to explore the Pyramid from top to bottom with the difficulty generally increasing with the depth of level. Depending on the choice of exit from each chamber you are likely to have a different game every time you play.

Apart from the challenge of trying to achieve the highest score possible the pyramid contains a number puzzle to solve. The more chambers you successfully visit the more information is gathered to enable you to discover the secret numbers of the pyramid. The puzzle won't take you a few days to solve, it will probably take you a few months.



This is "ZIGGY". He is shown above in his exploratory capsule and is a true representation of the on screen graphics. You have total control over his movements as you explore the many chambers of "THE PYRAMID".



FANTASY SOFTWARE
is available from W.H.Smiths,
John Menzies and
Computers For All

Compatible with all leading joysticks.

THE PYRAMID

**For 48K
Spectrum**

THE PYRAMID is available at £5.50 from
FANTASY SOFTWARE, FAUCONBERG LODGE, 27A ST. GEORGES ROAD, CHELTENHAM, GLOS GL50 3DT
despatched by return first class post together with a membership number entitling you to discount
on our forthcoming blockbusting software.

Trade Enquiries welcome — telephone 0242-583661

SOFTWARE

CREEPERS

Made by: Virgin Games
Price: £5.95

Creepers is the strange sounding name of Virgin Games new game for the 8K expanded VIC-20.

Upon loading the first section of the program you are presented with instructions in colour! They explain that you are in control of the last fighter, providing the final defence of your subterranean cities energy supply.

On the screen your fighter is controlled by either the joystick or keyboard. It can face left and right but only move up and down. To the left the aliens power store is built up when they have enough you are, naturally enough, "doomed to die". To the right the aliens cling to the ceiling and descend to take your energy blocks which are situated to the bottom right. You must try to destroy them before they get the energy blocks or after when they ascend at twice their descending speed. On sheet one the aliens drop one by one and on sheet two they drop in bunches of two, etc. If the aliens manage to relieve you of all your bricks in a particular zone they mutate and attack you.

Not only do aliens attack your energy blocks but "watchers" may appear and "watch" you, then remove all blocks in a zone in one swoop.

The game requires good eye-hand coordination and speedy reflexes. In play it is colourful with reasonable sound effects with mainly user-defined graphics.

Two points which weren't so hot are:
1. The screen is not centered very well; and
2. Where does the title "Creepers" come into it?
Can anyone tell me?

CRAWLER

Made by: Computer Rentals Ltd
Price: £5.00

You may be familiar with games guiding caterpillars around the Spectrum screen gobbling bugs (a useful attribute for a micro game) and avoiding deadly mushrooms. If you are, then you already know this game. The caterpillar is constantly on the move. You may turn him (or her?) anticlockwise with the 1 key and clockwise with the 0 key. These are well chosen controls but they're all you get. Your only other choice is the speed of the game, a range between 1 and 9. The faster speeds are

almost impossible. At 9 the caterpillar seems to race off the screen before you've a chance to press a key though a little practice makes it almost manageable.

I think this game will pall with extensive play — it lacks variety and visual attraction, though the programming and the display are perfectly competent. There is also a tactical drawback in play. If you keep pressing the same key, thus travelling in a perpetual square, sooner or later the bug wanders into your clutches. This is a boring way to play but reasonably effective and indicates the failure to consider how players will really play and what they actually want from a game.

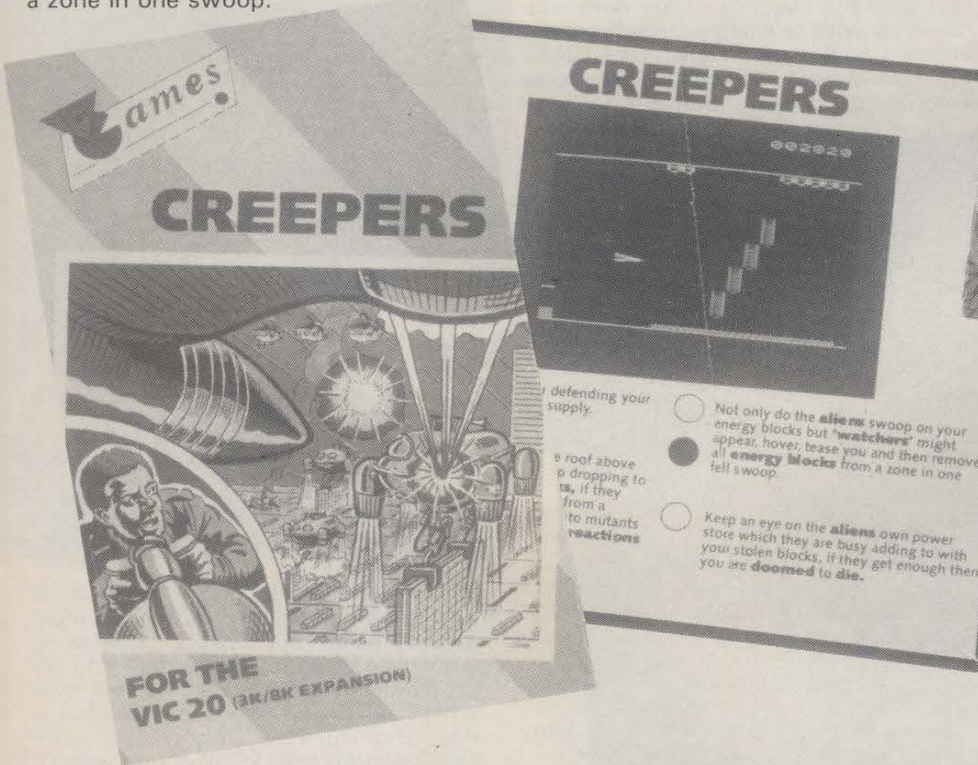

QUEST ADVENTURE

Made by: Hewson Consultants
Price: £5.95

You can't do justice to a game as complex as this in three hundred words. Yes, it is a traditional adventure, but it is not just problem solving, and neither is it purely wandering through mazes, or just fighting monsters nor just wielding mighty spells. On first sight it appears one of those infinite games of 'fight and wander' which starts by choosing a

REVIEWS

SOFTWARE

character type (in this case wizard, cleric, rogue, fighter or simpleton) and ends with a message like "you die of lack of constitution" (whatever that means) when you've bitten off more than you can chew. Well, it is one of those games. However it is almost as complex as some (Fantasy Role Playing) games in its combat system, using a concept called 'combat adds' from these games to calculate quite complex fights. However it does not give the player much control over tactics or weapon so is still more limited than its tabletop ancestors.

But hack and slay is by no means the end of the story. In addition to having to defeat sundry malignant beings you must also solve a series of puzzles as in the other type of adventure which is so popular. Here you must find objects, carry them to the appropriate places and discover their uses. You might think a game which tries hard to be interesting and varied for FRP gamers will be pretty unoriginal in its puzzling. Wrong again! The puzzles are difficult, the mazes complex and the Hobbit-like graphics are very pleasant. True there are not many illustrations and they sometimes do not match the text (the ornate bridge has no decoration at all, for example) but even 48K runs out. Needless to say, I have not yet solved it (has any reviewer ever solved an adventure before he writes the review?) but I am greatly enjoying the attempt. A very satisfactory game. What we need now is an adventure which combines artificial intelligence and 3D moving graphics with this kind of complexity. That would be a game and a half! Anyone out there writing one?

MY NAME IS UNCLE GROUCHO, YOU WIN A FAT CIGAR

Made by: Automata UK Ltd
Price: £10

Automata have certainly NOT done it again. This latest release is not of the same standard as PIMANIA, although its graphics and musical content are similar.

The idea is to travel the streets of America, using cigars as currency, to obtain 22 revealing giving the identity of the Mystery Star. The program loaded first time, which is just as well because it was re-loaded with monotonous regularity. Whether or not I have a duff tape I cannot say, but if not then Automata are wasting their time and money with this one. Firstly when you run out of cigars the whole cassette needs re-loading just to re-start, which means there is the initial screen to go through all over again... A little long and drawn out. Then when I asked for HELP twice the machine was Newed for me. Finally another bug decided to NEW the machine when a simple reply was entered... Oh well!!! Here we go again.

As to actually playing the game, I cannot give much comment, due to the fact that the majority of my time was taken up with re-loading. However, the areas I did visit were very good graphically and musically. The small amount of conversation I did have

responded well and seemed bug free. Hopefully I have been unfortunate enough to receive a defective cassette because I expected great things from Automata again and this program does not meet those standards.

THE PYRAMID

Made by: Fantasy Software
Price £5.95

A game that is massive in concept, consisting of a Pyramid with a base of fifteen rooms, giving the whole Pyramid a total of 120 rooms. The idea is to guide ZIGGY (yourself) down through the Pyramid from room to room and head for the central chamber on the base level. This is accomplished by use of crystals which neutralise the force fields protecting each room. However, the crystals can only be used when on their lowest power which also makes



them vulnerable to attack. Each room has its own occupants, whom you must destroy from your small capsule using your disintegrator. Fortunately you are protected by a force field of your own which can absorb any aliens you bump into. Unfortunately, this reduces your field strength and destroys you when it runs out altogether. As if that isn't enough, there is also a number puzzle to solve en route and failure to do so will mean you cannot enter the central chamber.

The screen displays of the rooms are excellent with plenty of colour and adequate sound. The aliens are also very

colourful and a delight to watch.

Each chamber contains four pieces of information, 1. Shield Points remaining. 2. Number of aliens to be destroyed before the next crystal appears. 3. Chamber Number and 4. Time remaining. Between chambers the current score and high scores are given as well as a diagrammatic view of your position. There are seven options for play, four using a Joystick and three using the keyboard.

Overall, a good release from Fantasy Software, at a reasonable price.

GOLF

Made by: Microdeal
Price: £8.00

Being a frustrated Golfer this golf program from Microdeal made me think that I could solve all my problems and save myself time — whoever heard of completing nine holes in ten minutes?

The program gives you the option of three levels of play and a full choice of

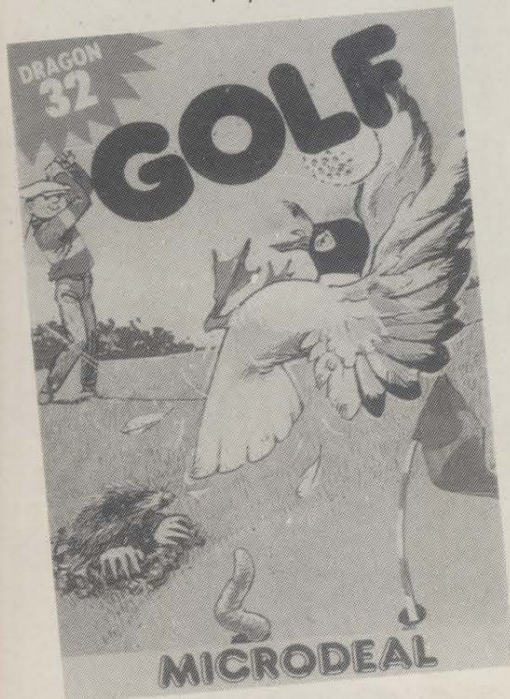

clubs. The fairway is displayed in hi-res graphics and you are given the various parameters, distance to the hole, par etc. The various hazards, water, bunkers and rough are displayed. You direct the ball using the clock face method and there is a built in hook and slice element. For the non-golfer this means that the computer expects you to miss-hit the ball and therefore it doesn't always go in the direction you expect, just like the real thing.

I found the number of miss-hits to be higher than I think the average golfer expects — or at least admits to! After playing a few rounds I had convinced myself that the sooner I got back on the golf course the better — I was playing worse on the machine than for real!

STAR QUALITY GAME OF THE MONTH

QUINTIC WARRIOR

Made By: Quicksilva
Price: £7.95

Quintic Warrior is one of four new games brought out by major software producer Quicksilva. And if this game is anything to go by Quicksilva may yet again make a quick kill in the software market.

You are a Quintic Warrior in the seemingly impermeable Dome City patrolling, when your computerised defence system rather unfortunately decides to backfire — just as some deadly aliens, the Zororian Mutants, are arriving in large numbers. So, not only are you fighting the Zororian Mutants with their deadly 'Zead Rammer' but your own highly sophisticated main defence as well. However, you have one advantage — the Quintic Factor — a combina-

tion of many qualities needed to become a Quintic Warrior. So with these attributes you set out to save your people and the Dome City.

This game is played with Joystick only and if pulled back will select up to 21 playing levels. You start with three lives and one is added after each level is completed (no mean feat!). If you are hit by a Zed Bolt or a Lazer Snare you lose one life, if you get caught by a Mutant you sustain damage of 1/10 of a life and if a Mutant reaches the top of the screen the game is over.

Quicksilva describe this as an 'Arcade mega game' which is not far from the truth. It has the ingredients of originality, addictivity, and playability which should make it a hit, deservedly.

Harmless fun for those winter days or nights when you fancy a quick round — but frustrating because there are only eighteen holes — they forgot the nineteenth!

BEWITCHED

Made by: Imagine Software
Price: £5.50

Locked doors, coloured keys, and a host of ghosts are the ingredients in this maze masterpiece. At the top of the screen are four keys in different colours through which you must pass. Moving through a key changes your 'man' to the same colour as the key, and you are then able to unlock all the doors of similar hue on the screen. Unlocking a door reveals either a hole or a wall in the maze. As you make your way through the maze an increasing number of ghosts arrive to hamper your progress.

The object of the game is to unlock all the different coloured doors to make your escape. However, just when you think that you have reached the end, the screen scrolls down to reveal yet another maze. To change the colour, you have to go all the way back to the top and start again.

I do not recommend attempting this game with a monochrome TV. A lot of time can be wasted in trying to decide which two shades of grey are the same!

The game offers a choice of joystick

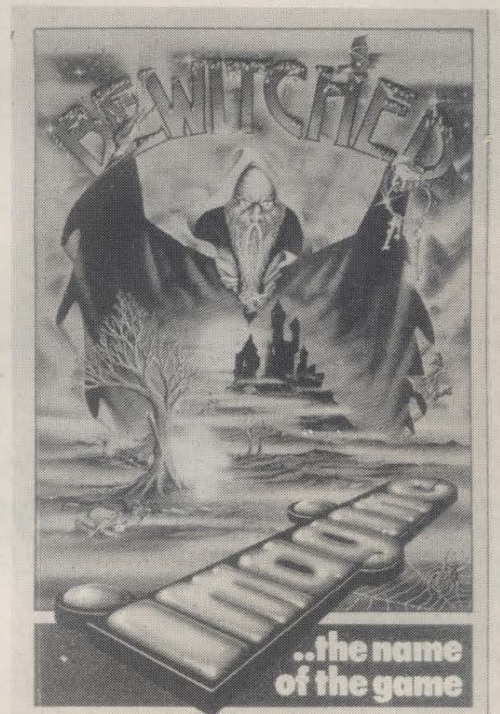

REVIEWS

SOFTWARE

or keyboard control: in the latter case and are used for left and right, and P and A are used for up and down. A better arrangement could have been chosen.

The presentation on screen is clear and sound and sound well incorporated. All in all this game has good, challenging entertainment value.

ROBOPODS

Made by: Virgin Games
Price: £5.95

This is another of those 'bash the aliens before they getcha' which seems to go down well with kids. I tried it out on a group of 10-year-olds at a local school and it went down a treat, but that may have something to do with the process involved. Some quite gruesome Robopods are going to try and take over the Earth and of course you have to do something about it — namely to deactivate them, avoiding mines as you do so. The method of doing this involves trekking round the screen, visiting each Robopod in turn (they are numbered and you MUST deactivate them in the right sequence).

Excellent use is made of graphics manipulation and the game is actually quite educational, because in your movement round the screen you must not cross your own footsteps — unless special mats appear enabling you to do so — and this requires the player to visualise moves some way ahead as well as find the best route. Dawdle and you are lost. The instructions are adequate and on-screen. Control is effected through either keyboard or joysticks, and there are 5 skill levels. PB.

SPACE SHUTTLE

Made by: Microdeal
Price: £8.00

Space Shuttle from Microdeal is one of the best programs I have come across for the Dragon 32. It is impressive from the start with attractive styled packaging and a fully comprehensive 'flight manual'. Before embarking on the game a through read of the manual is essential.

The purpose is to take the Space Shuttle into orbit on a predetermined flight path, dock it with a rogue satellite, rescue the satellite, load it into the Space Shuttle's cargo bay and then re-enter the earth's atmosphere and land the shuttle safely. And that's all!?!

It sounds easy, but first with the use of rocket jets you have to manoeuvre

the shuttle into a very tight 'window' for orbit. You play against the clock and there's little or no room for error. Once in orbit you have to get them up along close to the satellite for the 'rescue' mission. If the clock beats you in those stages, don't worry because the automatic pilot takes over and gets you there — but of course you don't score any points. Before attempting to complete the mission you must accomplish the rescue stage, there's no time limit and you always succeed. Whatever happens you always finish up scoring some points! Next come the re-entry

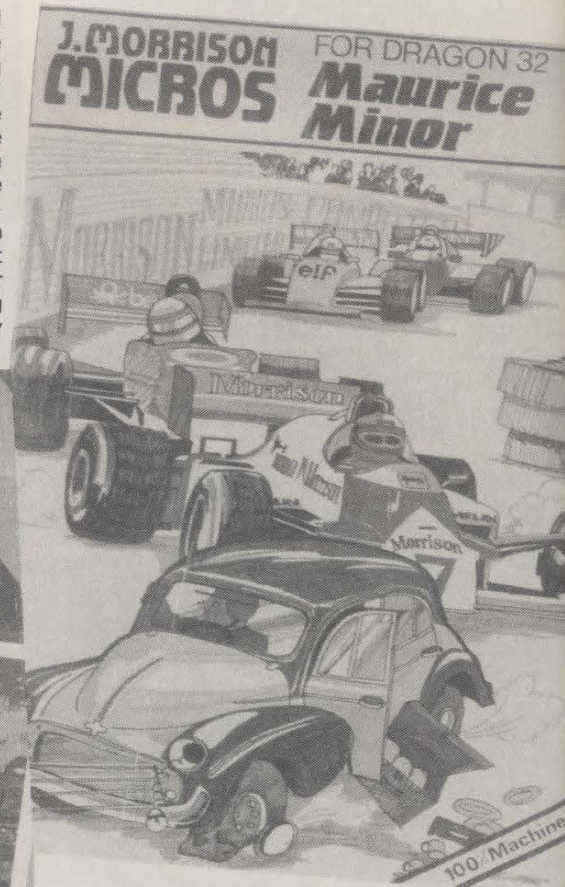
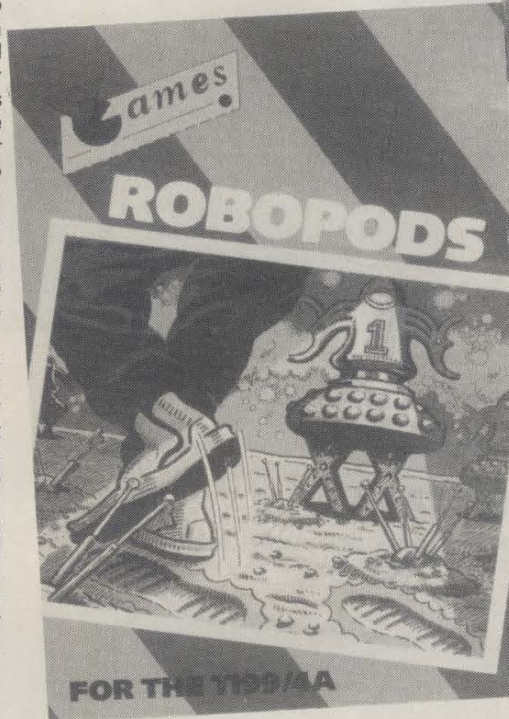

MAURICE MINOR

Made by: J. Morrison Micros
Price: £6.95

Right from the moment this game first loads you know it's going to be good. An auto-run with a very nice display page. Then it asks your name, tough if you have more than six letters in your name, like me, as the computer only takes six letters. Then a choice of skill is chosen, not just 1-6 but ranging from Grannie, through Wizzkid, to Kingpin. Six levels in all. Sorry to waffle on but I do feel that the beginning of a program is just as important.

Well, the idea is to drive your stray 'maurice minor' round a race course, avoiding crash barriers, oil slicks, and of course the oncoming cars. To gain and loose speed the fire button is used. To steer; the joystick. One slight moan is that the screen scrolls from right to left, I would much prefer top to bottom. Also, on the subject of moans, I think ten miles is a little too far to go, especially in a 'maurice minor'!

and landing procedures. These are the most difficult to achieve — and failure results in a crash. I've played it many times and each time when I think I'm getting the hang of it I've always been brought to earth with a big bump. But don't be dismayed. I asked a friend, a professional airline pilot to try, and he crashed it each time. But he did feel that given the usual six months conversion course that any pilot has to go through he would ultimately be successful!

The program is written by a NASA employee and follows as closely as possible the manoeuvring of the real thing.

The program makes use of the Dragon's high resolution graphics and joysticks are essential. As I said — a fascinating game.

REVIEWS

ANIROG SOFTWARE

COMPUTER GAMES OF TOMORROW
AVAILABLE
NOW!

KRAZY KONG

NEW APPROVED GAME FOR
THE STACK LIGHT RIFLE

COSMIC COMMANDO £5.95



VIC 20 16K EXP.

KRAZY KONG	K.B./J.S.	£7.9
GALACTIC ABDUCTORS	J.S.	£7.9
3D TIME TREK	J.S.	£5.9
XENO II	J.S.	£7.9
SKRAMBLE	J.S.	£7.9
FIRE GALAXY	K.B./J.S.	£7.9

VIC 20 UNEXP GAMES

MINI KONG	K.B./J.S.	£5.9
FROG RUN	K.B./J.S.	£5.9
SLAP DAB	K.B./J.S.	£5.9
DOTMAN	K.B./J.S.	£5.9
CAVERN FIGHTER	K.B./J.S.	£5.9
CRAWLER	J.S.	£5.9
TINY TOTS SEVEN	K.B.	£5.9
SEVEN PROGRAMS (VOL. 1) & (VOL. 2)	K.B.	£5.9
BATTLE FIELDS	K.B./J.S.	£5.9

ADVENTURE GAMES

THE DUNGEONS	K.B.	16K EXP.	£5.9
DARK DUNGEONS	K.B.	16K	£5.9
ZOK'S KINGDOM	K.B./J.S.	16K	£5.9
PHAROAH'S TOMB	K.B.	16K	£5.9
DRACULA/LOST IN THE DARK	K.B.	UNEXP.	£5.9

24 HR. CREDIT CARD SALES HORLEY (02934) 6083
PAYMENT BY CHEQUE, P.O., ACCESS/VISA
8 HIGH STREET HORLEY, SURREY.
Overseas 50p post & packaging

TRADE ENQUIRIES WELCOME

29, West Hill Dartford, Kent. (0322) 92513/8

Start

Oh damn, damn, damn! I've done it again, cut myself off from my home on the river bank, for what must be the thousandth time. I always seem to have to cross roads and rivers every time I want to get home. It really isn't fair, you know, really. Anyway, at least I don't have to cross the river. So much for the turtles, crocodiles and logs. Still there's an interesting change in the form of a railway line, complete with trains, which must be going about twice as quickly as the cars, and twice as fast as me. That should keep me on my toes. All this to get back to my cosy home...

This game is a variation on the "Frogger" theme, but with trains replacing the river. The trains are to be avoided, as are the cars, but move twice as quickly as frog can hop. Each frog which reaches home gains a score bonus, 3 frogs gain an extra bonus. A player is given 3 lives and 30 seconds to get frogs home. Continuous counts of time, lives and score are given at the top of the screen.

Doubling the speed of the trains was more difficult than it may sound. To do this I had to double the lengths of all 6 strings controlling the trains & cars, write the loop for 2 movements (44 characters) rather than 1 (22 characters) then half the speed of both cars & frog. On screen during the game will be the counts, the river bank and homes, 3 rows of trains, a border, then 3 rows of cars, and a white frog somewhere in there. Controls are given.

RUNdown

5 Gosubs to intro and clears memory for defined graphics.

10-15 Sets strings for cars & trains, sets hiscore to 0 and hiscorer to empty string.
18 Sets variables.
19 Clears screen & prints riverbank.
20 Sets screen colour, screen & volume.
21 Starts loop for movement and checks if frog is due to move.
22-25 Checks for key press & react accordingly.
26 Changes character used for frog, pokes white frog on screen.
32-37 Changes text to multicolour & prints strings controlling cars and trains in position reached according to PP the main loop variable.
38 Pokes the multicolour auxiliary to black, as explained in issue 1 of PCT.
39 Prints count & border.

FROGGY

By P Sidell

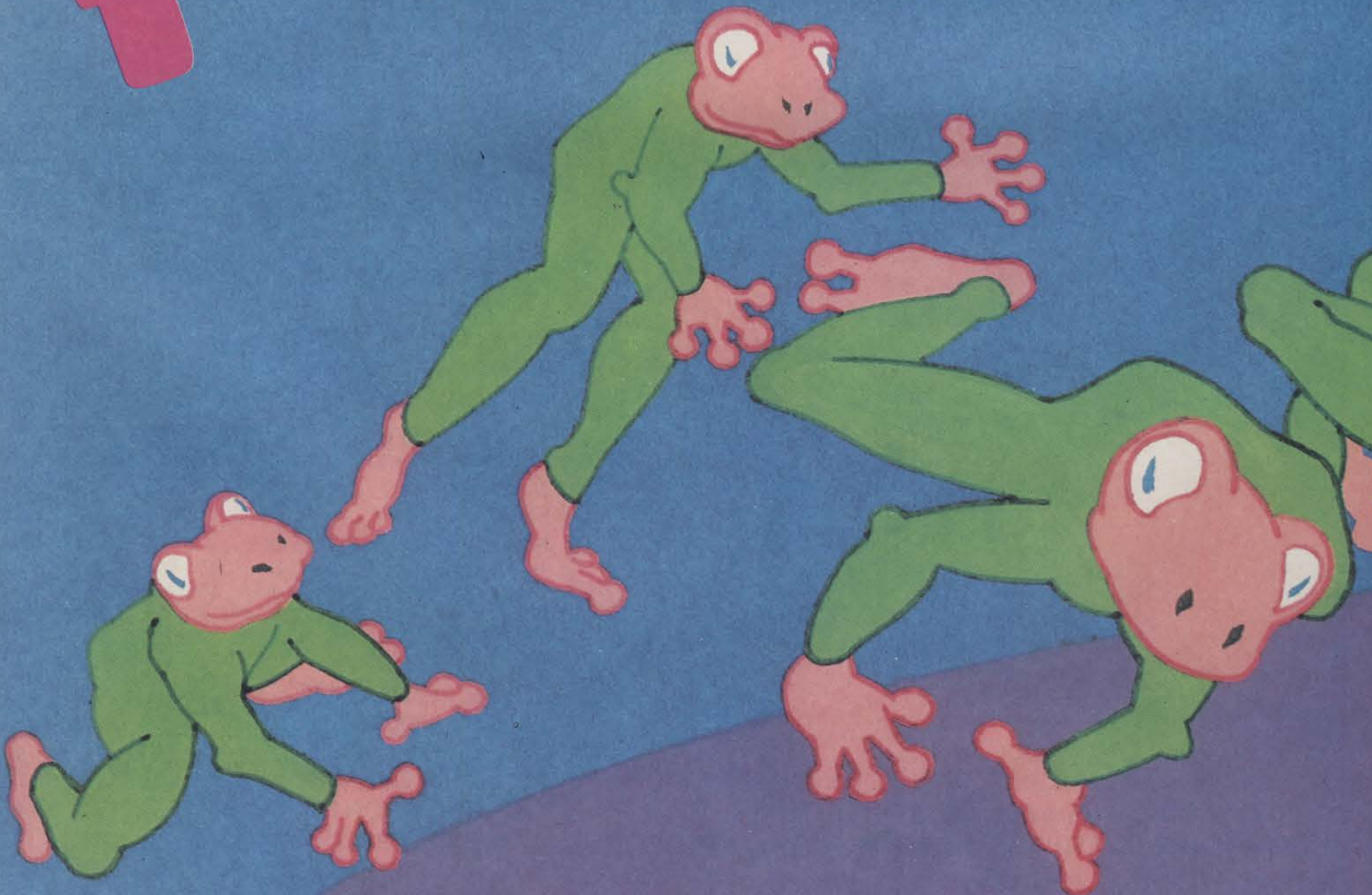

40-44 Check if the frog has been hit: if not jump to 50.
 46 If frog has been hit jump to 61.
 50 Checks time delay.
 51 Continues loop, restarting if necessary.
 52 Bleep for moving upwards.
 54 Bleep for moving downwards.
 59 If frog is home jump to 65.
 60 Subtract 9 from score: frog has jumped to row 9 but hit the bank, so does not gain any score.
 61 "Splat" sound, add 1 to lives lost, and jump to 70 if 3 lives lost.
 63 restarts frog: resets variables, repositions frog, starts time and jumps to checks.
 65 Add 10 to score and bleeps for getting frog home.
 66 Add 1 to frogs home, jump if 3 home.
 67 Restarts frog as in 63.
 70-74 GAME OVER: ask player if he wants another go.
 75-77 If Y is pressed, restart game. If N is pressed, end. Otherwise, continue checking.
 80 Noise for 3 frogs home.
 84 Resets variables, increments score, and resets top row of trains of 6 frogs have reached home.
 85 Reset top row of cars if 12 frogs have reached home.
 86 Goto game start.
 900-904 Data for defined graphics.
 950 Display titles.
 951-961 Display explanation & controls.

990 Define graphics.
 992 Check for a key pressed.
 993 Jump to start of program.

Variables Used

Strings
 A\$-F\$ Strings for trains & cars.
 H\$ Hiscorer.
 C\$ Home then several cursor downs.
 T\$ Used for get statements.
 Numeric
 C 30720 i.e. the difference between the screen & colour addresses.
 F 0 or 1: character currently used for the frog.
 FH No. of frogs home.
 HS Hiscore.
 I,U,W Loop variables.
 J Adds 5 each time 3 frogs reach home.
 L Lives lost.
 PI Keyboard peek, value for key pressed.
 P ½PP, used for the car movement lines 35-37.
 PP Main loop variable.
 Q Position of frog.
 R Row of frog.
 S Score.
 Z Control determining whether or not frog shall move.

Conversion Clues

As has been mentioned, the movement of trains and cars was achieved by rotating the strings, using LEFT\$ and RIGHT\$. On some machines this will need to be replaced by (TO X) and (ZTO). The VIC's inbuilt clock, TI\$, is used which may not be compatible with some machines and so a count will have to be introduced in its place.

To produce the cars, the VIC's multicolour ability was used. POKEing 646 changes the text colour, a number between eight and 15 giving multicolour text. Other POKES used were:

Line 5 Clears top of RAM.
 Line 20 36879,93 changes screen to total green.
 36869,255 changes screen to user-defined mode.
 36878,15 sets volume to maximum.

PEEK(197) reads the keyboard, and can be replaced by INKEY\$ or GET\$.

Lines
 52-54 Bleeps.
 Line 61 Splat.

POKES between 36874 and 36876 control the sounds.

Line 70 POKE 36869,240 sets the screen back to text mode.

Line 990 reads characters into RAM then replaces some with user-defined characters.

Line 992 is a more efficient method of waiting for a key to be pressed.

Q is a position on the screen, starting at 7680, then in 23 rows of 22 up to 8185. The colours start at 38400, hence C = 30720 (38400-7680).

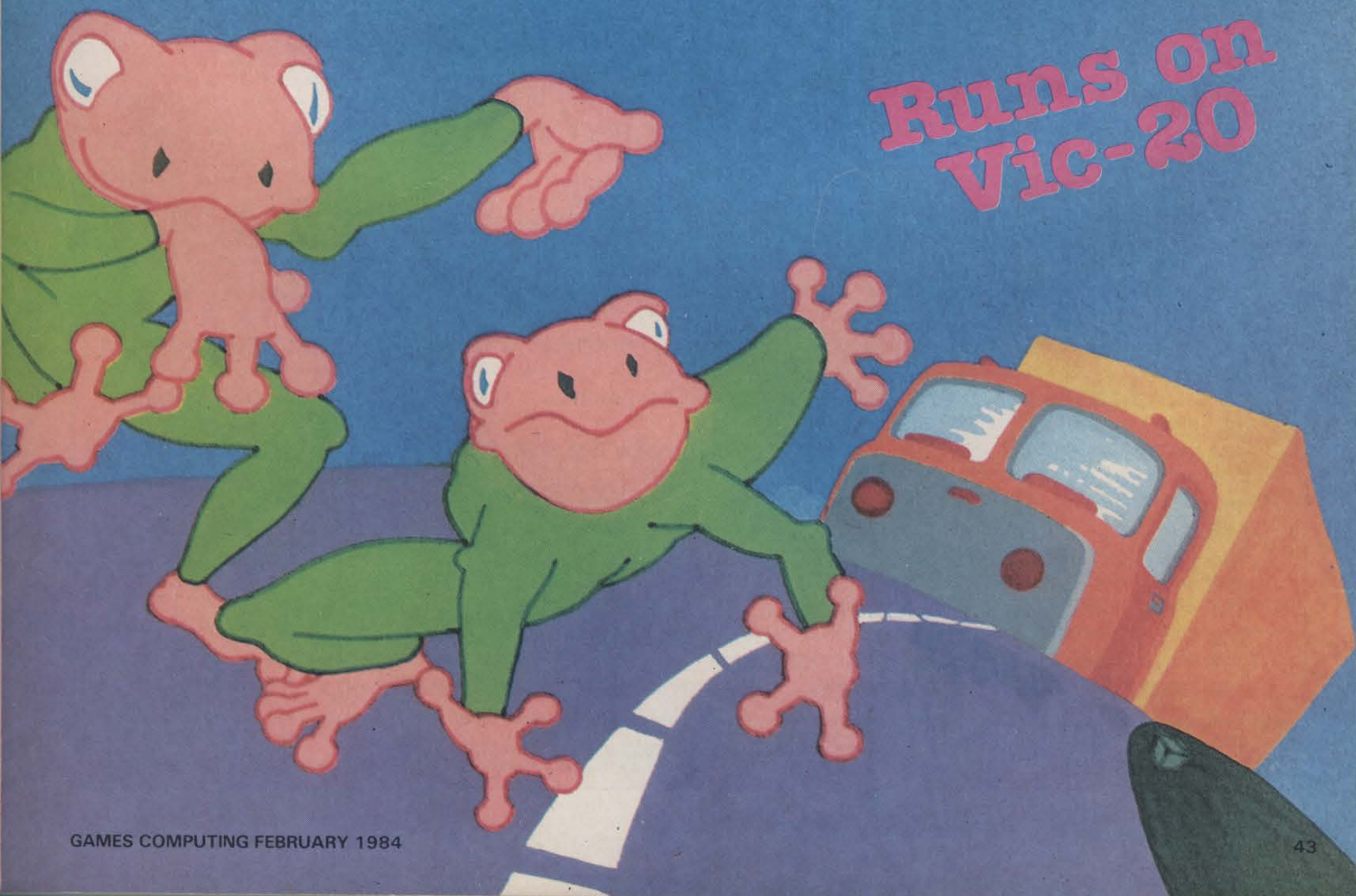

AGF

PROGRAMMABLE JOYSTICK INTERFACE for Spectrum or ZX81

MICRODRIVE
COMPATIBLE



ABOUT OUR INTERFACE

The AGF Programmable Joystick Interface is a unique design offering the use of any Atari-compatible joystick with absolutely all software, whether it is cassette or ROM cartridge, with the Sinclair Spectrum or ZX81.

The hardware programmable interface requires no additional software and accurately replicates the keys of the computer in a manner which is responsive to absolutely ALL key reading methods, both BASIC and Machine Code.

The interface does not interfere with key operation and can therefore be used simultaneously with the keyboard.

There is no need to remove the interface once fitted as the rear extension connector will accommodate further expansion, i.e. printers or RAM packs etc. This important feature avoids excessive wear to the expansion port.

The key replication principle pioneered by AGF means that your own programs can use eight directional joystick movement by utilising simple key reading BASIC.

Two joystick sockets are provided which share the same keys, for use with the majority of two player games. Several interfaces may be used on the same computer for multiple joystick applications.

The interface is programmed by a two digit code, which is looked up on a programming chart supplied, for each direction and firing button. The two numbers are then selected on a pair of leads which are clipped onto appropriately numbered strips on the interface.

Once configured this can be marked on a Quick Reference Programming Card for storing with the game. As the programming is *not* power dependent the interface retains the last configuration made and can be immediately used when next switched on.

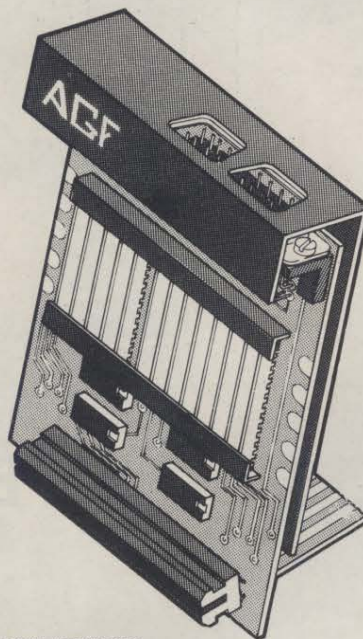

KEY FEATURES

- ★ Programmable design gives TOTAL software support.
- ★ Accepts Atari, Competition Pro, Wico, Starfighter, Quick Shot, Le Stick etc.
- ★ Rear extension connector for all other add-ons.
- ★ Free demo program and instructions.

PACKAGE CONTENTS SUPPLIED

- Programmable Interface Module as illustrated, complete with clip-on programming leads.
- Self adhesive programming chart detailing how to define which key is simulated by UP, DOWN, LEFT, RIGHT, and FIRE. This can be fixed on to the case of your computer or if preferred the protective backing can be left on. The chart is made of a very durable reverse printed plastic and is extremely easy to read.
- One pack of ten Quick Reference Programming Cards for at-a-glance setting to your games requirements. The card allows you to mark the configuration in an easy to read fashion with space to record the software title and company name.
- Video Graffiti demonstration program which is written totally in BASIC to illustrate how all eight directions and fire can be read. This is also a useful high resolution drawing program.
- 12 months guarantee and full written instructions.

JOYSTICKS

CONTROLLERS

FOR USE WITH OUR INTERFACE Module or VIC 20, Commodore 64, Atari VCS, Atari 400, Atari 800

If you require extra Joysticks for our original interface module mark order 'OLD' Joysticks

ONLY £7.54 inc VAT + P&P

FROM: MR/MRS/MISS			
ADDRESS			
SEND C.W.O. (NO STAMP NEEDED) TO: A.G.F. HARDWARE, DEPT.GC,			
FREEPOST, BOGNOR REGIS, WEST SUSSEX, PO22 9BR			
QTY	ITEM	ITEM PRICE	TOTAL
	PROGRAMMABLE INTERFACE	33.95	
	JOYSTICK(S)	7.54	
	PACK(S) QUICK REFERENCE CARDS	1.00	
ONE	VIDEO GRAFFITI	FREE	
ZX81 <input type="checkbox"/> ZX SPECTRUM <input type="checkbox"/>		Please tick	
DEALER ENQUIRIES WELCOME		EXPORT PRICES ON APPLICATION	
		FINAL TOTAL	

...O.K. on all issue Spectrums...

★ ATARI OWNERS ★

Would you like **more games listings**? How would you like to learn to **write your own games**? Or read reviews of the **latest Atari software**? Or discover how to get **free software** from Bulletin Boards?

You can do all this and more by subscribing to PAGE 6 magazine — the U.K. magazine for Atari computer users. The magazine is produced to a professional standard, A4 size with a glossy cover and includes specialist advertising you might not otherwise see.

The annual subscription is £6 for six bi-monthly issues. Send your £6 now to:

**SUBSCRIPTION DEPT., PAGE 6,
18 UNDERWOOD CLOSE, PARKSIDE,
STAFFORD.**

If you are not fully convinced of the value of a specialist Atari magazine, just send £1 for a sample copy.

**PAGE 6 - THE BEST MAGAZINE FOR
THE BEST COMPUTER**



J. P. MAGNETICS LTD

Specialists in the supply of bulk custom wound audio/computer cassettes.

**Trade and educational enquiries welcome, duplication facilities available.
Price list and samples on request.**

For the Private User 10 x C15 for

£4.50 + 75p p&p

(Cash with Order)

**UNIT 4, 7 MARY STREET,
BRADFORD**

TEL: 0274 731657

NEW HOME COMPUTER CABINET

£79.95

incl. VAT & Delivery

JUST CHECK THESE STANDARD FEATURES

- 1 Smooth sliding shelf locks in position just where you require it — and neatly glides away after use.
- 2 The computer shelf has been designed to allow adequate 'Knee room' for you to sit comfortably, and will avoid 'programmers backache'.
- 3 Adequate room to position tape recorder, printer, disc-drives, etc, alongside computer for ease of use.
- 4 All cables neatly and safely out of sight, while allowing all units to be permanently connected if desired.
- 5 Lots of storage space for cassettes, cartridges, books, listing paper, joysticks, etc.
- 6 With shelves and doors closed, instantly becomes an elegant piece of furniture.
- 7 The lower shelf accommodates all makes of video recorders currently available.
- 8 Smart teak effect finish.
- 9 Supplied as a flat-pack. Very simple to assemble, using just a screwdriver. Full instructions supplied.
- 10 Measurements: Height 32 1/2 ins, Width 36 ins, Depth 16 3/4 ins.



TERMS OF OFFER UK Mainland Customers only. Please allow up to 28 days for delivery.

HOW TO ORDER Send Cheque or Money Order for £79.95 to:

MARCOL CABINETS, P.O. Box 69, High Street, Southampton

For further details telephone (0703) 731168

ARCADE ACTION & ADVENTURE WITH...

..The Guardian

You are at the Gateway to the Anti-Matter World of Migon do you dare enter will you survive?

48K SPECTRUM
£5.95



Krazy Kong

All machine code, super fast action. 4 screens of fireballs, barrels & conveyor belts.

SPECTRUM 48K
5.95

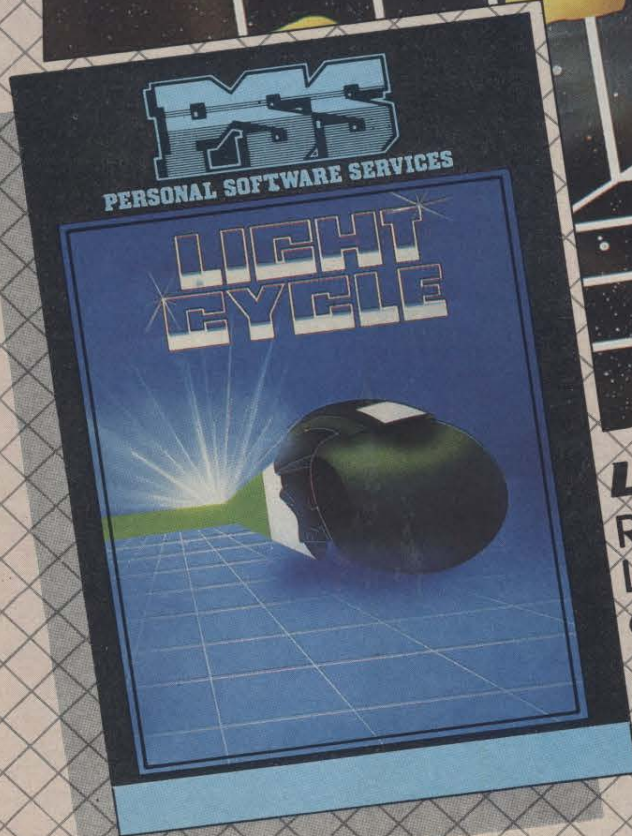

Light Cycle
Race your Light Cycle on the infamous grid. Fast action all the way.
SPECTRUM 16K 48K 5.95

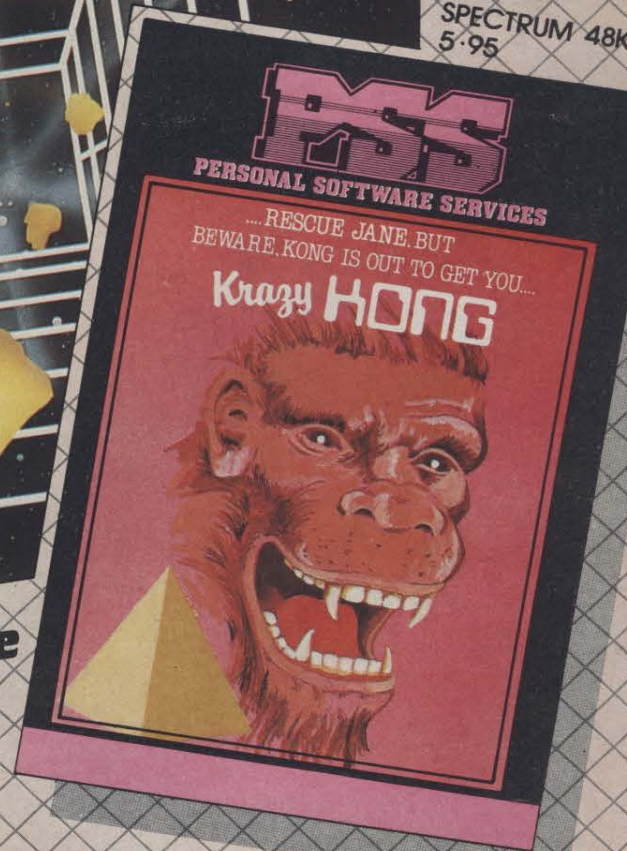

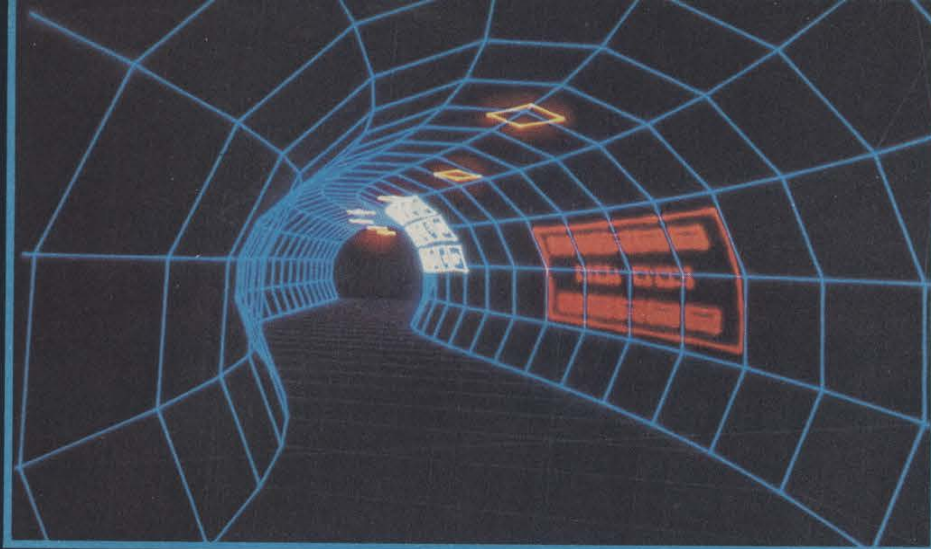

Simon Rockman found out all about computer animation at a recent London exhibition. And, who knows, maybe you'll be able to use similar graphics to those pictured in the not too distant future.

Today's home computers are capable of producing displays which not long ago would have required hardware costing many thousands of pounds. By looking at current state-of-the-art (up-to-date) technology we can see what might happen with domestic computers in the future.

High resolution graphics are very expensive in terms of memory and processing power but with advances in chip technology taking place so quickly the kind of graphics which are now used to produce such stunning effects as television's Channel 4 logo may soon be with the home user. However, to use these super powerful tools computer owners will have to learn the tricks of the trade. The data structures required by graphics are all based on heavy mathematics and even devising the graphics to form a simple twisting cube is playing with maths. In the same way that you don't need to know assembler to write a BASIC program, tools will be developed to make life easier. But a knowledge of what the computer finds easy and what is difficult, in other words what takes time and what it can do quickly, will make graphics programming more elegant.

Making Pretty Pictures

One quite common trick is called anti-aliasing. This relies on shading to produce a smooth edge. Even on systems with quite high resolution you get a jagged or 'staircase' effect when lines are not parallel or at 45 degrees to the X or Y axis. The higher the contrast between the line, which may be the edge of a shape or an outline, and the background the worse it looks. This can be subdued if between a white edge and a black background a medium grey line is inserted, then between the medium grey line and the black line a dark grey line is inserted and between the medium grey line and the white edge a light grey line is inserted and so on.

With about 16 levels of intensity the edge does not look too thick on a large enough display and gives a smooth looking effect. Character sets with this done on them have been tried and are

much easier and less tiring to read. This technique is frowned upon by the really big boys of computer graphics who argue that you should have high enough resolution not to have to cheat in this way these really large firms use supermini computers and mainframe computers. MAGI, who along with a firm called Triple I produced the film TRON for Walt Disney, use a Cray 1 which is one of the most powerful computers in the world. As do the New York Institute of Technology who are one of the leaders in developing new avenues within the field of computer graphics.

Bringing Computer Graphics To The Public

However, time on these large computers, which cost from about £2 million upwards, is very expensive and so beyond the budget of many of the people who would like to use them. It is the advertising agencies that we have to thank for a lot of the development in the use of computers to generate pictures for print and television. These agencies only have a limited amount of time in which to make an impact so the cost of a second of time is less important to them than it is to a television producer. As a result the best animation can be seen advertising tyres, toothbrushes and vacuum cleaners!

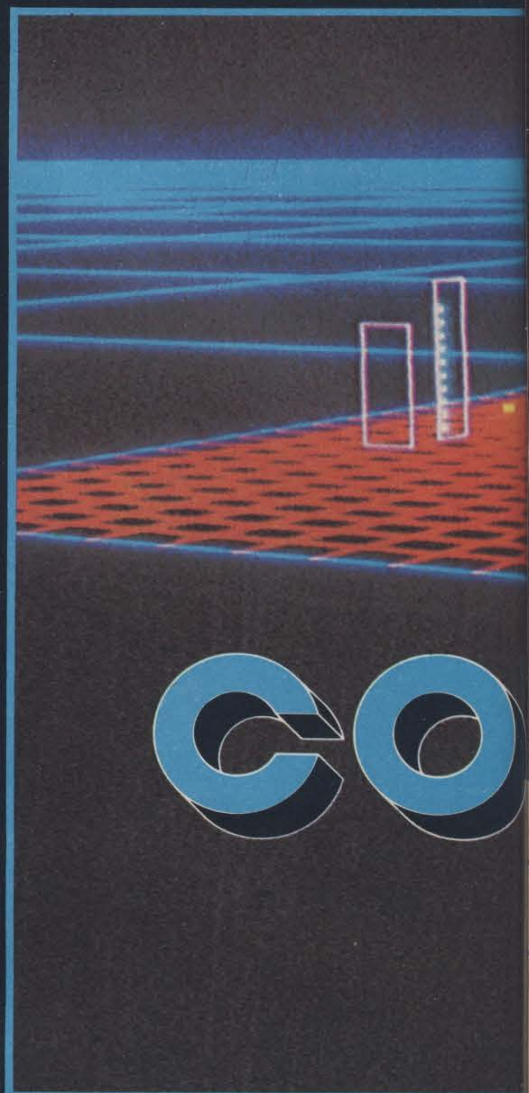

The annual showcase for computer graphics is the Computer Animation Film Festival. This is organised by exhibition firm Online who do a lot of computer conferences and the Festival this year was compared by Barry Norman. This show was wonderful! All the exhibitors were there to show off their displays and the resulting quality of the films was stunning. Hopefully it was a taste of things to come.

There was a totally computer

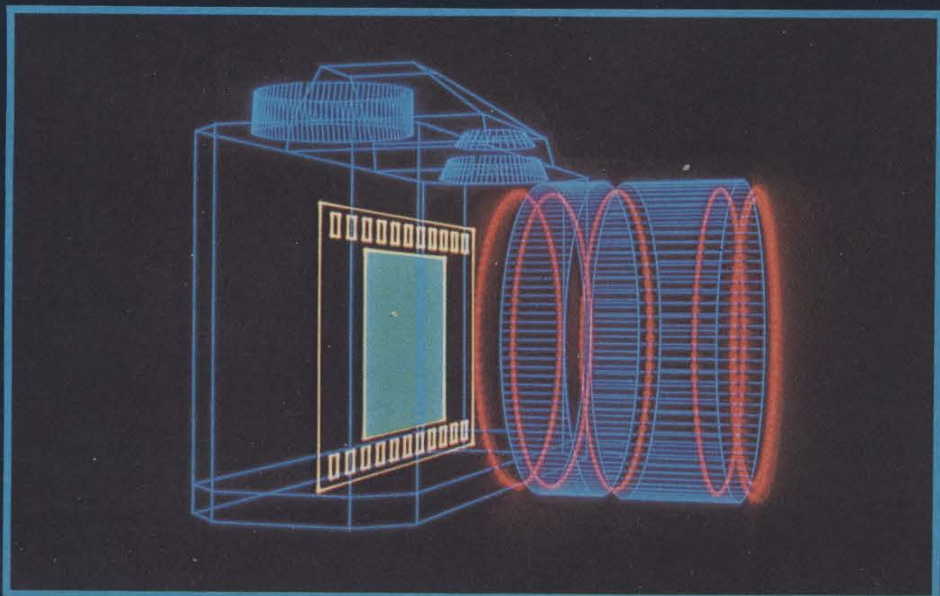

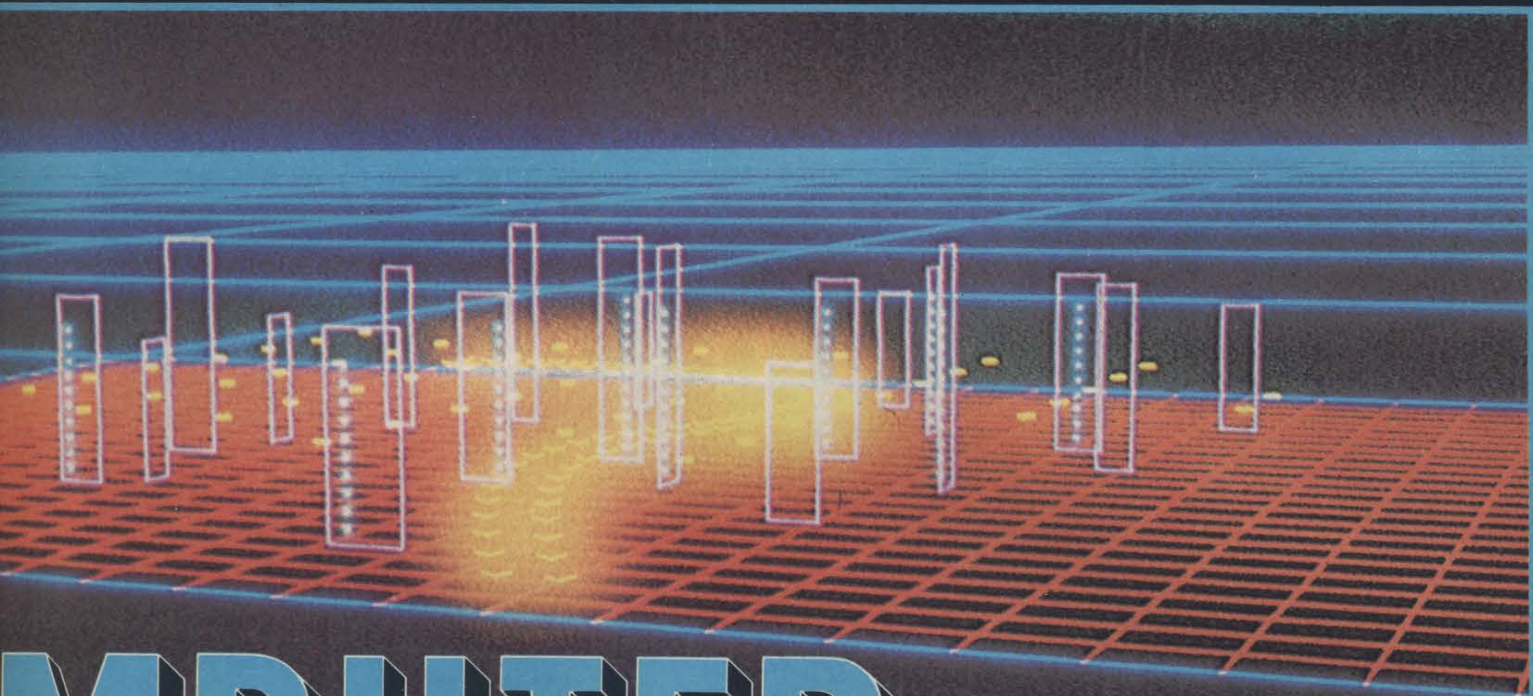

MPUTER ANIMATION

generated television programme (sorry program, it was from America), introduced by two characters called "Dotmatrix" and "Userfriendly" who made quips at one another and likes their real life compatriots. Also shown was a clip of some ant-like robots using machinery to build a dome. This was done with some superb animation and cute characterization. Also shown were excerpts from the animated TV series "Terrahawks", the film "Return of the Jedi" and title sequences to various television programmes.

The room for expansion into television to produce Tron-type programmes is enormous. As micros get more and more powerful perhaps we will see computer animation competitions along the lines of current film making competitions, but with entrants submitting a disc instead of a film. What will be needed is a good selection of Computer Aided Design (CAD) software. The BBC Micro already has some in the form of Quicksilva's 'Designer' program and Acorns implementation of the Robocom 'Bitstick' looks spectacular. However, for animation it will be necessary to have some very clever software with fast fill routines, inbetweening to fill in frames for you and perhaps 3D manipulation. With this you could enter into the computer six views of, say, a

telephone and the computer could do all the work of drawing it tumbling towards you. Nothing like this yet exists on micros, the nearest thing to it is IO Research's PLUTO system. This is a purely graphics system and the keyboard, screen and computer are extras starting at £500 going up to beyond £5000. Even this system is

slow in animation terms. Big systems have many megabytes of RAM resolution beyond 1024 by 1024 and palettes of something like 16.7 million colours and price tags with at least four zeros on the end, so it may be some time before you get home, sit down at your 32 bit micro and start to rival Hollywood!

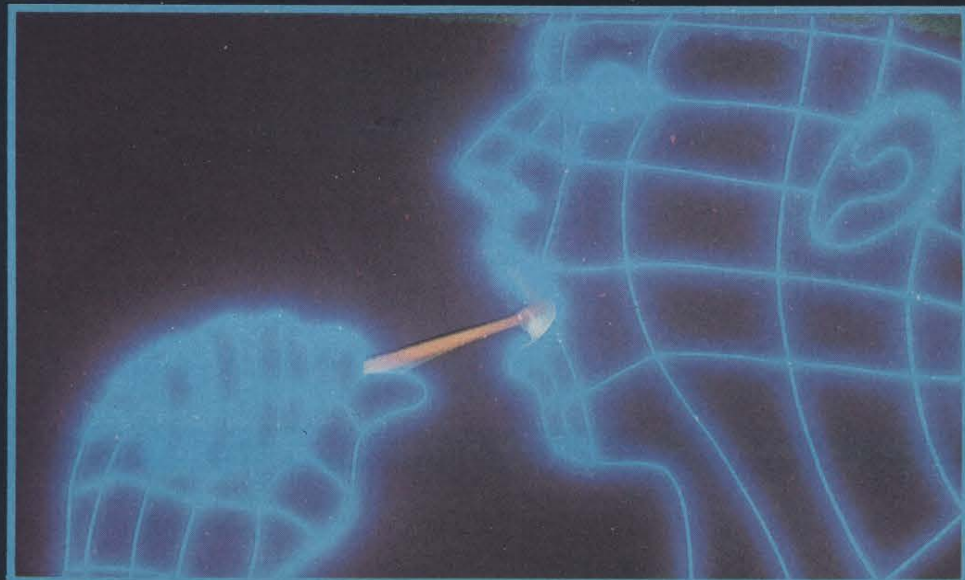



ASP SOFTWARE

A STEP BEYOND THE ARCADE...



Demon Knight · The Valley · Strategy 1—Invasion · Strategy 2—Bismark
White Barrows · Detective · Cells & Serpents · Stockmarket
Conquering Everest · Cloneit/Renumber · Gallery of Death · Planetfall

HORNSBY



ASP SOFTWARE
145 Charing Cross Rd, London WC2H 0EE
Tel: 01-437 1002

Now available from:

Telford Electronics
 Inside Bambers
 Telford Town Centre
 Shropshire

John W Bagnall Ltd
 18 Salter St
 Stafford ST16 2JU

Mega Ltd
 7 Anley St
 St Helier
 Jersey

Computer Cabin
 24 The Parade
 Silverdale
 Newcastle
 Staffs

Software City
 3 Lichfield Passage
 Wolverhampton
 W Midlands

D A Computers Ltd
 104 London Rd
 Leicester LE2 0Q2

Fal Soft Computers
 8 St Georges Arcade
 Falmouth
 Cornwall TR11 3DH

Statacom Ltd
 234 High St
 Sutton
 Surrey

William Smith (Booksellers) Ltd
 University Bookshop
 White Knights
 Reading RG6 2AH

The Car Shop
 103 Lower Lickhill Road
 Stourport

Canterbury Software Centre
 9 The Friars
 Canterbury
 Kent CT1 2AS

JCV Organisation Ltd
 Units 7/8
 Wharf St
 Warwick
 CV34 5FO

3D Computers Ltd
 230 Tolmouth Rise South
 Surbiton
 Surrey

Vision Store
 96/98 North End
 Croydon CR0 1UD

Philip Copley Hi Fi Ltd
 6 Wisley Street
 Clifford Court
 Ossett
 Wakefield
 N Yorks

Micro North
 7 Broad Street
 Bury
 Lancs

4-Mat Computing
 67 Friargate
 Preston
 Lancs

Channel 8 Software Ltd
 51 Fishergate
 Preston
 Lancs

Windsor Computer Centre
 Thames Avenue
 Windsor
 Berks

Rush Hi Fi & Video
 5-6 Cornhill
 Chelmsford
 Essex

Amersham Computers
 18 Woodside Rd
 Amersham
 Bucks

Godfreys
 30 East Walk
 Basildon
 Essex

Estuary Software Products
 261 Victoria Avenue
 Southend on Sea
 Essex

Software Centre
 128 Wigmore St W1

Dimension
 27/29 High St
 Leicester

Vic Oddens
 5 London Bridge Walk
 London SE1

Computer Plus
 2 Church Lane
 Banbury
 Oxon

K P Cameron & Computer Shop
 12a Kings Parade
 Cambridge

Gemini Electronics
 50 Newton St
 Manchester

Sherwoods Photographic Ltd
 11-13 Gt Western Arcade
 Birmingham B2 5HU

Brainwave Micros Ltd
 24 Crown St
 Ipswich
 Suffolk IP1 2LD

Micro Business Centre Ltd
 17-19 Lichfield St
 Wolverhampton WV1 1EA

Trend & Hi Fi Video
 167 High St
 Walthamstow
 London E17 9PD

Eddy's (Nottm) Ltd
 ENL Audio Visual
 116/118 Alfreton Rd
 Nottingham NG7 3NR

Cannock Computer Systems Ltd
 18 Old Penkridge Rd
 Cannock
 Staffs WS1MZ

G Foster
 C B TV Hi Fi & Video
 Sales & Service
 59 Tamworth St
 Lichfield
 Staffs

For Sharp
 MZ-700
 Computer



95B Blackpole Trading Estate West, Worcester
 Tel: (0905) 58351

Please
 mention
GAMES
COMPUTING
 when replying
 to all
 adverts



**KARMA
 SOFTWARE
 PRESENTS**

PONTOON — YHATZI

For 3K Expanded **VIC 20** only **£4.50** inc VAT × P&P

FREE Games Tape while stocks last.

Cheques & PO's to:

**TM COMPONENTS, 119a HIGH STREET
 SOUTHEND-ON-SEA, ESSEX SS1 1LH**



A&F Software turns y

CRAZEE CONG



**Runs on
Sharp MZ80A**

By Andrew Comley

The game is based on a popular video game. The objective is to remove all the rivets in KONGS scaffold structure. However, he has in his employment several fireballs whose touch is lethal. Another hazard is, if you reach the fourth level several of the squares that you can jump on flash on and off.

To help in your mammoth task are two lifts adjoining levels 3 and 4 and the possible formation of two extension ladders from levels 1 to 2.

On screen will be a layered scaffold

structure with ladders adjoining the plugs appear as inverse "H" signs. Lifts are based on a criss-crossed square: it operates just by stepping on it. Your man is a small character man and the fireballs are white faces. It is possible to jump over the fireballs but it is extremely dangerous.

Variables Used

a1 : number of men.
 a2 : bonus.
 a3 : number of plugs removed.
 a4 : level of play.
 a5 : score.
 b1-b6 : locations of fireballs.
 b7 : top left corner.

j : location of man.
 c1 : display code for plug.
 c2 : display code for fireball (white face).
 c3 : display code for a space.
 c4 : display code for a little man.
 c5 : display code for a white square.
 c6 : display code for a ladder section.
 p1 : (41) position right lower diagonal of character (depending on sign).
 p2 : (40) position directly below character (depending on sign).
 p3 : (39) position left lower diagonal of character (depending on sign).
 p4 : (80) position two squares above character (depending on sign).

CRAZEE CONG





CRAZEE CONG

Conversion clues

The program is written for a Sharp MZ 80-A and so conversion to the Sharp MZ 80-K is relatively simple. The only alterations being character codes and the command "CURSOR X,Y : PRINT" which is analogous with "PRINT @ X,Y;".

For other machines conversion should not cause too many difficulties. Locations start at 53248. It is a 40 column display. The list of variables will show the display codes for characters but no high-resolution graphics are used.

The noise routines are: a FOR NEXT loop containing "POKE 4514,X : POKE 4513,X : USR (68) : NEXT : USR (71)". Apart from these easily converted parts the rest of the program consists of fairly standard BASIC. If the program is scanned it will be seen that many, generally unimportant parts can be excluded from the program without causing irrevoicable damage for example the set/reset routine if your machine cannot handle these commands.

Rundown

Line	Action
10-65	Initialises variables.
91-93	Flashing squares: POKE character or space on rnd command.
100-250	Movement of fireballs: addition to rnd No. to location.
300-340	Checks to see if you have walked over a rivet or a bonus.
350-370	Checks to see if you have walked over a rivet or a bonus.
380	Checks No. of plugs removed if greater then 9 level increases by one.
400-490	Looks to see if part of a ladder is in one square vicinity and replaces missing parts in that region.
500-530	Routine for jumping three places to right.
540-590	Checks to see if you have jumped over a plug if so, score increases.

600-630	Routine for jumping three places to left.
640-690	As lines 540-590.
800-970	Sets up screen and plugs.
1000-1100	Movement of man and GOSUB routines as mentioned.
1100-1120	As lines 400-490.
1140	Checks if you fall down hole.
1150-1165	Depending on level moves to routine for moving fireballs and/or flashing squares.
1180	Bonus is depleted every time loop is completed.
1190-1197	Upper screen display ; score , bonus etc.
1200	If bonus is zero then lose one life.
1210-1240	Check to see if touching a fireball if so DEATH.
1250-1310	Routine for falling down hole.
1400-1420	Loss of life routine and end of game.
1655	Clear sheet routine i.e. level increases bonus adds onto score.
300-3195	Sets/resets intro. picture.
4000-4230	General rules and tips including ambidextrous hand control.
4500-4560	Explosion on falling through hole routine.
5000-5500	Death by fireball.
6000-6180	END OF GAME.
7000-9030	Routine elevating man on steps i.e. lift.

```

1 REM
2 REM Crazy Kong
3 REM by Andrew Comley
4 REM 1983
5 REM
6 PRINT "G":GOSUB3000:HS=1000:DIMR(7),B(7)
10 P1=41:P2=40:P3=39:P4=B1
11 A1=3:A2=5000:A3=0:A4=1:A5=0
20 C1=197:C2=206:C3=0:C4=202:C5=67:C6=163:A3=0
65 B(1)=53419:B(2)=53439:B(3)=53698:B(4)=53720:B(5)=53978:B(6)=53994:B(7)=53248
70 J=54107
72 PRINT "G":TEMP1
73 PRINT "#####"
74 FORV="TQAA"
75 PRINT " "
76 PRINT " "
77 PRINT " "
78 PRINT " "
79 PRINT " "
80 PRINT " "
81 NEXTV
82 PRINT "#####HOW HIGH CAN YOU TRY?":MUSIC"+C+D+E+F+G+A-B"
83 TEMP4
90 GOTO800
91 R(7)=INT(RND(1)*5):P6=499:P7=779
92 IFR(7)>2,STHENPOKEB(7)+P6,0:POKEB(7)+P7,C5
93 IFR(7)<2,STHENPOKEB(7)+P6,C5:POKEB(7)+P7,0
100 SR=F:FORF=1TO6
150 POKE(F)+R(F),C3
165 READR(F):IFR(F)=0THENRESTORE:GOTO165
170 POKE(F)+R(F),C2
180 IF(PEEK(B(F)+P2)=C5)+(PEEK(B(F)+P2)=C3)THENPOKEB(F),C3
190 NEXTF=SR
250 RETURN
260 DATA-3,4,1,4,-2,4,1,4,-1,4,1,4,1,4,1,0
300 REM WALKING PLUG CHECKS
310 IFPEEK(J+P1)=C1THENPOKEJ+P1,C3:GOSUB394:A3=A3+1:A5=A5+100
311 IF(PEEK(J)=B3)+(PEEK(J)=65)+(PEEK(J)=70)+(PEEK(J)=68)THENGOSUB 497
312 IFPEEK(J+P2)=166THENGOSUB 8000
320 GOSUB 380
340 RETURN
350 IFPEEK(J+P3)=C1THENPOKEJ+P3,C3:GOSUB 394:A3=A3+1:A5=A5+100
351 IF(PEEK(J)=B3)+(PEEK(J)=65)+(PEEK(J)=70)+(PEEK(J)=68)THENGOSUB 497
360 GOSUB 380
370 RETURN
380 IF A3>9THEN 1580
390 RETURN
394 FORF=0TO2:POKE4514,F:POKE4513,F:USR(68):NEXT:USR(71):RETURN
400 REM ** LADDER CHECKS **
410 IFPEEK(J+P1)=C6THENPOKEJ-1,C6
420 IFPEEK(J+P4)=C6THENPOKEJ-P1,C6:RETURN
430 RETURN
440 REM ** LADDER CHECKS **
450 IFPEEK(J+P4)=C6THENPOKEJ+P1,C6
460 RETURN
470 IFPEEK(J+P3)=C6THENPOKEJ+1,C6
480 IFPEEK(J+P2)=C6THENPOKEJ-P3,C6
490 RETURN
492 FORF=25STO1STEP-50:POKE4514,1:POKE4513,1:F:USR(68):NEXT:USR(71):RETURN
497 FORF=5TO1STEP-1:POKE4514,F:POKE4513,F:USR(68):NEXT:USR(71)
498 A5=A5+INT(RND(1)*750):RETURN
500 REM ** JUMP **
510 J=J-P3:POKEJ+P3,C3:POKEJ,C4:J=J+1:POKEJ-1,C3:GOSUB 410:POKEJ,C4
520 J=J+P1:POKEJ-P1,C3:GOSUB 420:POKEJ,C4
530 GOSUB992
540 REM JUMPING PLUG CHECKS
545 IFPEEK(J+P2)=C3THENGOSUB1250
550 IFPEEK(J+36)=C1THENPOKEJ+36,C3:A3=A3+1:A5=A5+100:GOSUB394

```

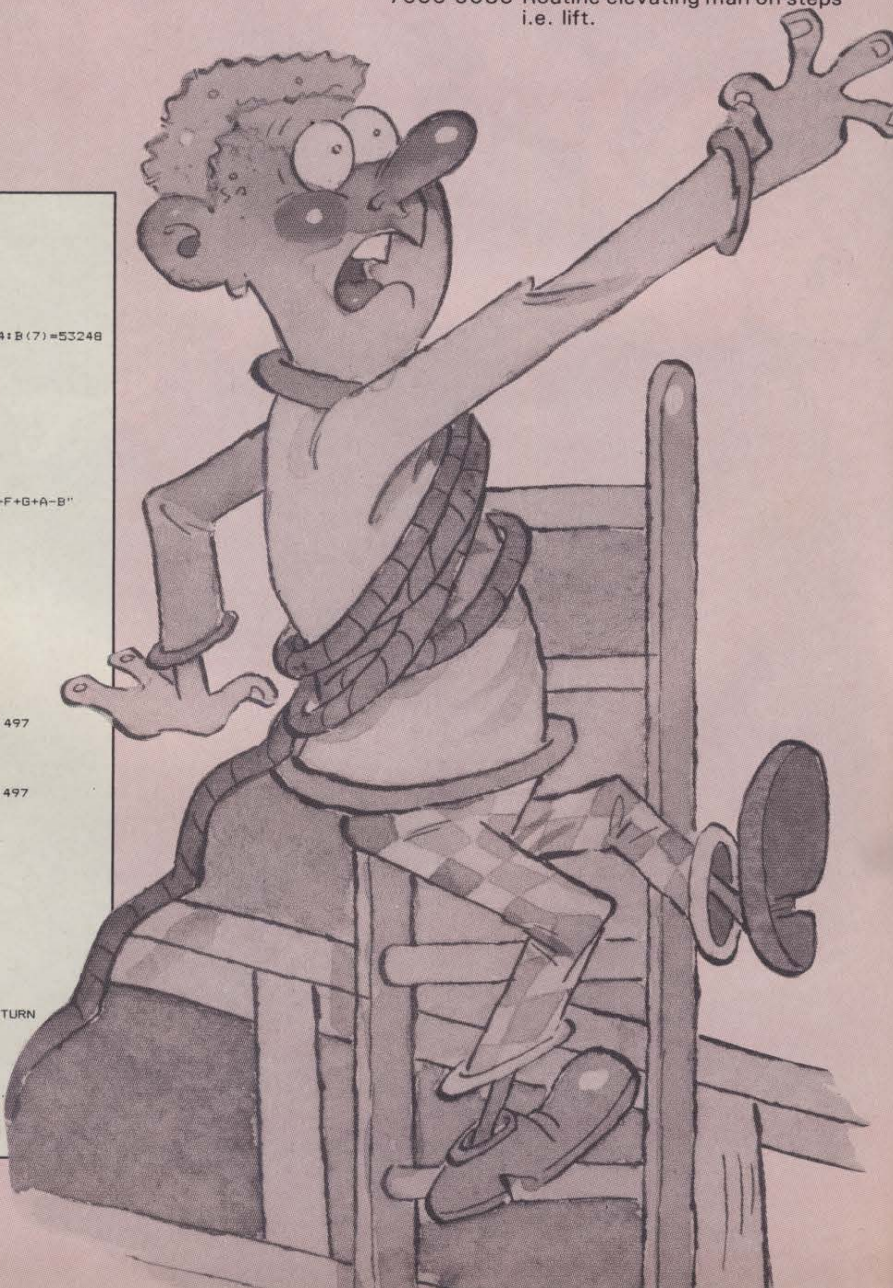

our world upside down



KAMAKAZI—£7.90 ARCADE STYLE GAME

Fast or slow, skill and speed are needed to beat the enemy aircraft determined to destroy your base. Skill and speed are needed to avoid being hit by enemy aircraft



PHARAOHS TOMB—£7.90 ADVENTURE GAME

Pick up the gold but don't be scared penniless by the mummy. Be quick—it's in real time, so work out those magic words.

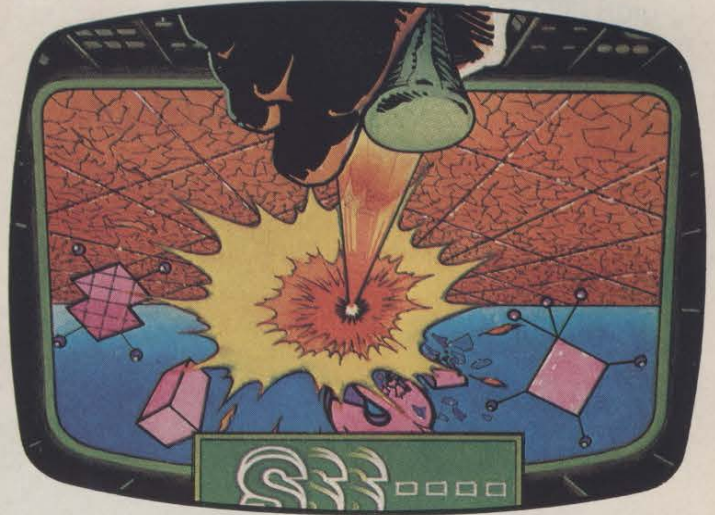

CYLON ATTACK—£7.90 REAL-TIME 3

Enemy cyllons on your long-range, off screen radar. Fire the high energy laser bolts when they come into range. Protective Shields against their missiles. Back to the mothership to refuel and then into CYLON action again.



CHUCKIE EGG—£7.90 A FARMYARD ARCADE STYLE GAME

Collect 12 eggs and some corn to finish the screen—but watch out, there are some nasty ducklings chasing you!

- CYLON ATTACK £7.90 REAL-TIME
- 3D SPACE BATTLE
- CHUCKIE EGG £7.90 FARMYARD ARCADE STYLE GAME
- KAMAKAZI £7.90 ARCADE STYLE GAME
- PHARAOHS TOMB £7.90 ADVENTURE GAME

A&F Software



Available from W.H. Smiths, John Menzies and all leading computer stores.

Direct from mail order dept. Tel: 0706 341111

Total Cheque/P.O. enclosed or credit card No.

Name

Address

A & F SOFTWARE Unit 8,
Canalside Industrial Estate,
Woodbine Street, East, Rochdale,
Lancs OL16 5LB. Tel: 0706 341111



PLAY IT AGAIN... WITH AN ACE IN YOUR HAND

- 100% BRITISH MADE
- 1½ METRE CABLE
- HIGH IMPACT PLASTIC CASE
- PLASTIC STICK WITH STEEL SHAFT

PRO-ACE[®]

COMPETITION JOYSTICK

NO MATTER WHAT THE GAME...
NOTHING PLAYS LIKE THE PRO-ACE
COMMODORE VIC 20/64 AND ATARI
COMPATIBLE PLUS NUMEROUS
VIDEO GAMES MACHINES

PLUS LEFT OR RIGHT HAND
FIRE BUTTON

PLUS CENTRE FIRE BUTTON

PLUS PURPOSE DESIGNED
SWITCHES

PLUS NON-SLIP
NON-SCRATCH BASE

A totally BRITISH designed
and manufactured Joystick
with a 2 year warranty!

Spectrum and BBC
Interfaces available.



Available from good computer dealers or direct
from Sumlock Microware.

Please supply PRO-ACE at £12.95 each.

I enclose cheque/P.O. for £



PCT-2

Name

Address

Tel

Price includes P + P U.K. only. Telephone: 061-834 4233

Manufactured and Distributed by
SUMLOCK MICROWARE
198 Deansgate, Manchester M3 3NE
Tel: 061-834 4233
Trade enquiries welcome.

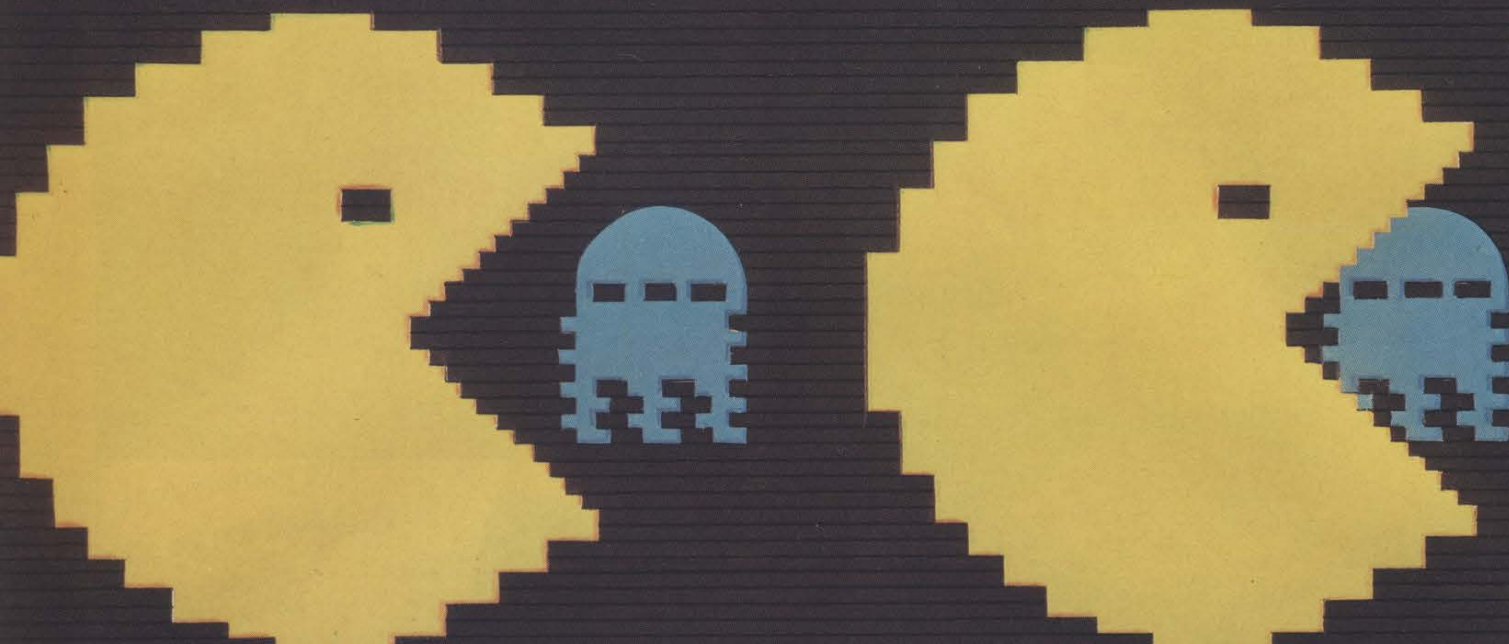

“Gobble”

“Gobble”

Now that Atari your computer, out Forget ghostly imitations. They need not darken your screens a **a ghost of** a moment longer.

Because now you can play Atarisoft™ games on your own home computer.

Pin-sharp graphics, quick slick movements – games that really challenge your skills.

Games so close to our originals, it's like having an “Amusement Arcade” in your own living room.

SINCLAIR ZX SPECTRUM: ALL AVAILABLE ON CASSETTE. OUT NOW – PAC-MAN,† MS PAC-MAN,† GALAXIAN,‡ JOUST,◇ OUT SOON – DONKEY KONG,* DIG DUG,□ POLE POSITION,△ MOON PATROL,◇ B.B.C. MODEL'B'/ACORN ELECTRON: ALL AVAILABLE ON CASSETTE. OUT SOON – MS PAC-MAN,† DONKEY KONG,* DIG DUG,□ POLE POSITION,△ JOUST,◇ BATTLE ZONE,® COMMODORE VIC 20: ALL AVAILABLE ON ROM CARTRIDGE. OUT NOW – PAC-MAN,† DONKEY KONG,* DIG DUG,□ OUT SOON – MS PAC-MAN,† GALAXIAN,‡ POLE POSITION,△ JUNGLE HUNT,▽ MOON PATROL,◇ STARGATE,◇ JOUST,◇ COMMODORE 64: ALL AVAILABLE ON ROM CARTRIDGE. OUT NOW – PAC-MAN,†

† PAC-MAN, MS PAC-MAN AND CHARACTERS ARE TRADEMARKS OF NAMCO LTD. ‡ TRADEMARK OF NAMCO LTD. * TRADEMARK AND © NINTENDO OF AMERICA INC. 1982, 1983. □ DIG DUG IS CREATED AND DESIGNED BY NAMCO LTD, MANUFACTURED UNDER LICENSE BY ATARI INC. △ TRADEMARK AND ©

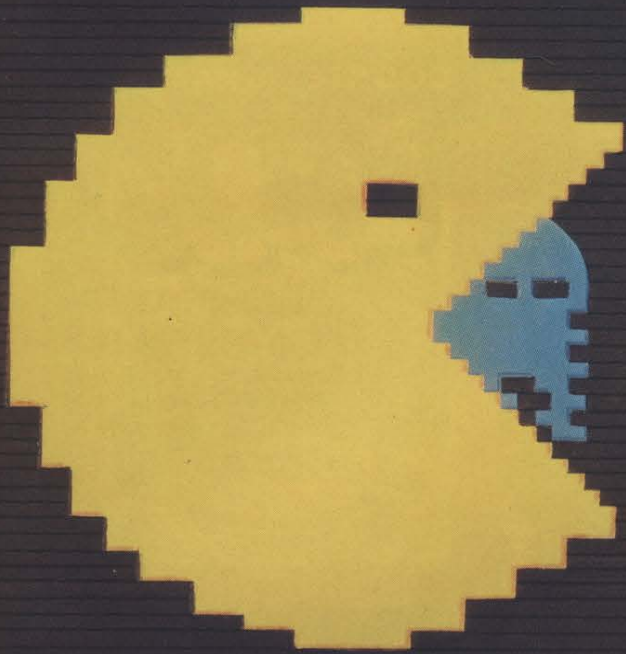

“Gobble”

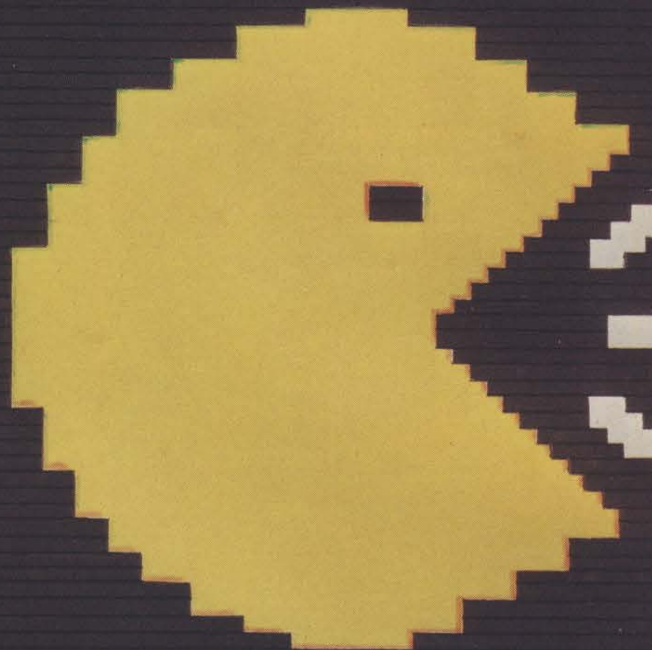

“Gulp”

make games for rivals don't stand a chance.

We've written the programs to suit your computer's exact requirements.

Look at our extensive range of titles. We will be adding to this list so that you can expand your library of Atari games. After all why choose a ghost now that you can have the real thing?

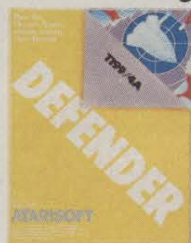
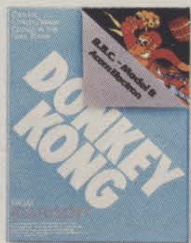

DUG, ROBOTRON, CENTIPEDE, DEFENDER, OUT SOON - MS PAC-MAN, GALAXIAN, JUNGLE HUNT, MOON PATROL, POLE POSITION, STARGATE, JOUST. TI 99/4A: ALL AVAILABLE ON ROM CARTRIDGE. OUT NOW - PAC-MAN, DONKEY KONG, DIG DUG, ROBOTRON, CENTIPEDE, DEFENDER, STARGATE.

For further information, write to Atari International (UK) Inc., P.O. Box 407, Blackhorse Road, London SE8 5JH.

ATARI **SOFT**™

LUNAR JETMAN – For the 48K Sinclair ZX Spectrum

LUNAR JETMAN – The Ultimate Intergalactic G.A.S. (Graphic Arcade Simulation) Adventure Space Battle.

LUNAR JETMAN – Arcade standard, 100% machine code, incredible sound effects, amazing smooth high resolution graphics, the totally new addictive concept and all those extra features you expect from the **ULTIMATE** games people.

Design – The **ULTIMATE PLAY THE GAME** design team.

LUNAR JETMAN – 48K ZX Spectrum

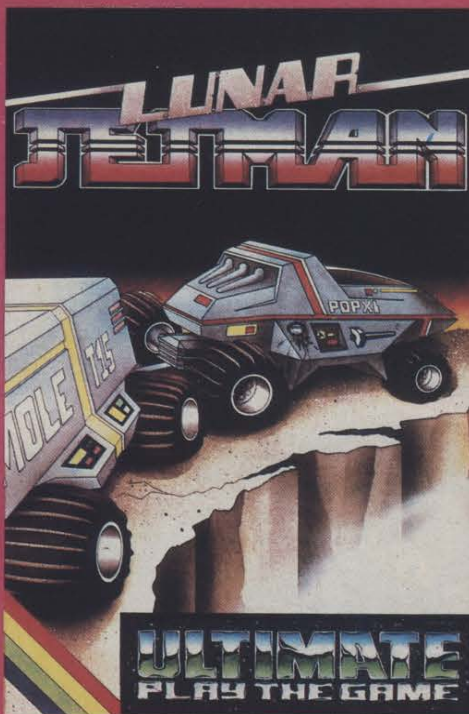

COOKIE – 16/48K ZX Spectrum

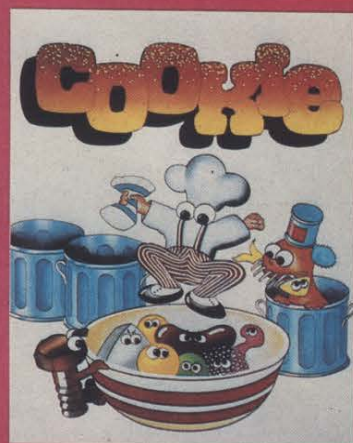

PSSST – 19/48K ZX Spectrum

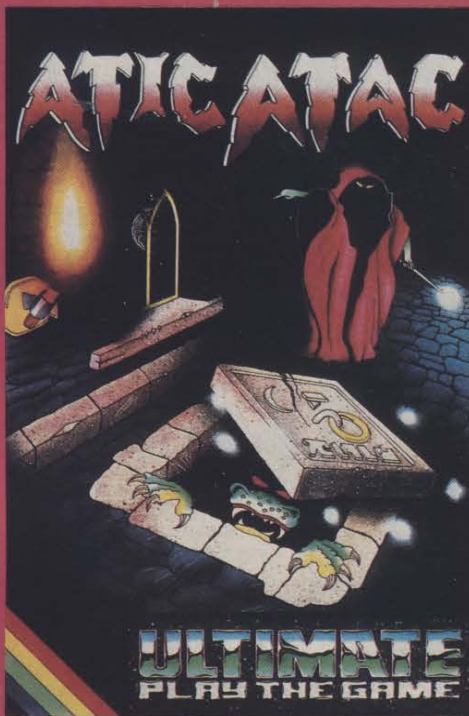

TRANZ AM – 16/48K ZX Spectrum

ATIC ATAC – For the 48K Sinclair ZX Spectrum

ATIC ATAC – The super spooky 3D horror G.A.S. (Graphic Arcade Simulation) Adventure Game.

ATIC ATAC – Arcade standard, 100% machine code, incredible sound effects, amazing smooth high resolution graphics, the totally new addictive concept and all those extra features you expect from the **ULTIMATE** games people.

Design – The **ULTIMATE PLAY THE GAME** design team.

JET PAC – 16/48K ZX Spectrum or 8K Expanded VIC 20

ATIC ATAC – 48K ZX Spectrum

Dealer enquiries welcome. Phone (0530) 411485

These games should be available from **W.H. SMITHS, BOOTS, JOHN MENZIES, LASKYS, SPECTRUM CENTRES**, other large department stores and all good major software retailers. Alternatively, send the coupon to **ULTIMATE PLAY THE GAME** for immediate dispatch by return, subject to availability.

£5.50 each including VAT, first class postage and packing within UK.

Post this coupon to:

ULTIMATE PLAY THE GAME, The Green, Ashby de la Zouch, Leicestershire, LE6 5JU

Please rush me the following:

- LUNAR JETMAN ATIC ATAC JET PAC
 COOKIE TRANZ AM PSSST
 JET PAC (8K Expanded VIC 20)

I enclose cheque/PO for £.....

Name.....

Address.....

.....

.....

Post Code.....

COMPETITION

Caption This: ▼

SOFTWARE AND SWEATSHIRTS TO WIN

All for you — free — courtesy of **Arcadia Software**. One of the country's leading games software producers has joined forces with *Games Computing* to bring you this competition which requires you to conjure up all the wit and humour you are capable of. One of the latest games from **Arcadia** is 'Pasta Blasta' which went on sale just prior to Christmas. It runs on the Oric 1 and sticks to **Arcadia's** tradition of producing true arcade style games software.

The firm originally started life two years ago selling software to run on the CompuKit 100 which is now defunct, but at the time was one of the few firms involved in the field. Then about a year ago **Arcadia**, which is run by Tony Love, ventured into the VIC 20 software market which at the time was one of the most popular games micro around. **Arcadia** went from strength to strength and now produce games specifically for the Oric 1 home computer. As games software has always been **Arcadia's** forte there is no likelihood that their policy will change, so we can all look forward to many more great products to emerge from the company.

In fact in January Tony Love's plans are to expand their range of games to cover the Commodore 64 and Spectrum, the first game being the very successful *Mushroom Mania* which will be available on both machines. And round about the same time you'll be able to buy one of **Arcadia's** special sweatshirts. As yet none are available but the shirts will feature a picture from *Mushroom Mania* and sport the words 'I'm a Mushroom Maniac along with an Arcadia logo.

WHAT YOU WIN

The winner of this competition will win a copy of each of **Arcadia's** range of games, one of the new sweatshirts and a year's free subscription to *Games Computing*. Altogether we will pick five winners of the competition. The four runners up will each receive a sweatshirt and a copy of each of **Arcadia's** games.

HOW TO WIN ARCADIA GAMES

It's easy. Below you'll see a copy of the cartoon used in all the latest **Arcadia** adverts. As you can no doubt see the picture itself is entertaining to look at, be it at a glance or by studying it. What we want you to do is have a good long look at the cartoon and write a caption for it. Be as funny as you can possibly be, but make sure that you make your

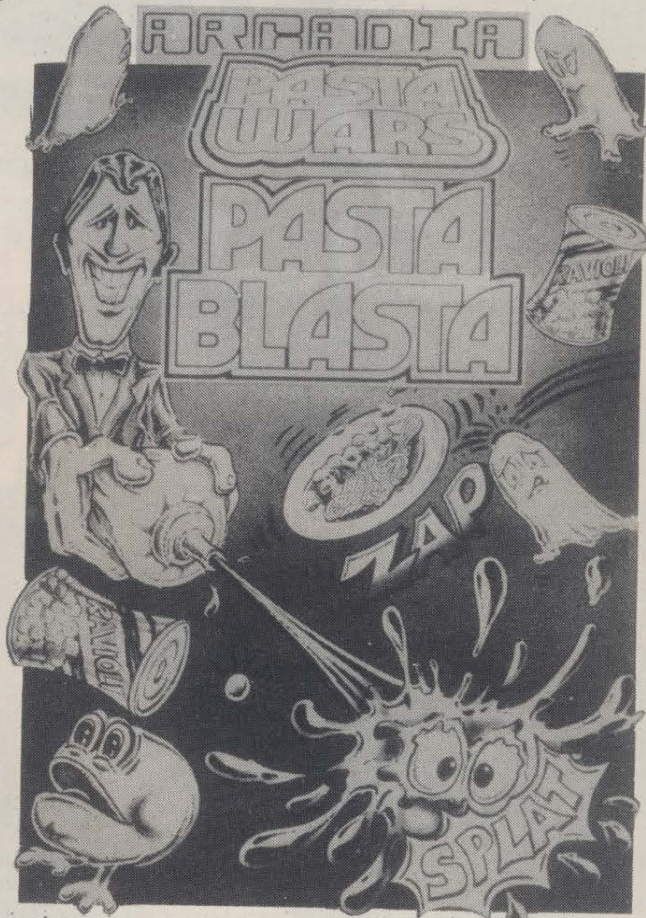
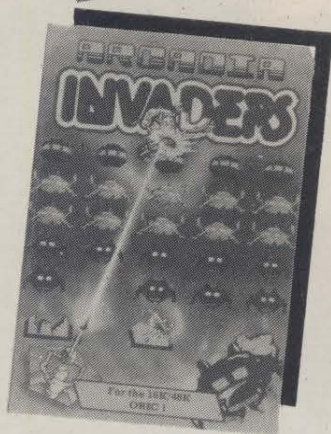
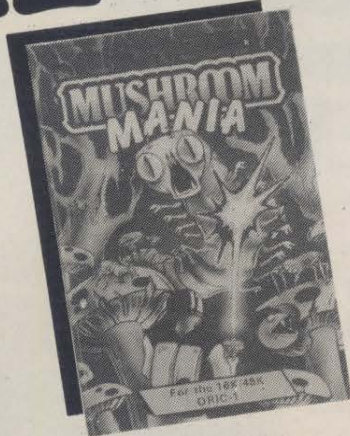

caption relevant both to the picture, either generally or a specific subject in it, and maybe relevant to **Arcadia**.

Once all the entries have been sent to us **Arcadia** and *Games Computing* will get together and pick out the most imaginative five. Make sure you fill in the coupon correctly and send it to the address shown.

COMPETITION RULES

1. This competition is open to all UK and Northern Ireland readers of *Games Computing*, except employees of Argus Specialist Publications Ltd, their printers and distributors, employees of Arcadia or anyone connected with them.
2. As long as the correct coupon is used for each entry, there is no limit to the number of entries per person, but photocopies of it won't be accepted.
3. All entries must be postmarked before February 29 1984.
4. The prizes will be awarded to the five entries judged to be worthy winners on merit by the Editor and Tony Love of Arcadia.
5. No correspondence will be entered into with regard to the competition results and it is a condition of entry that the Editor's decision is accepted as final.
6. The winners will be notified by post and the results will be published in a future issue of *Games Computing*.

Address to: ARCADIA/GAMES COMPUTING COMPETITION FEB '84

My cartoon caption is:

.....

Name Age

Address

.....

..... Telephone No



ORIC Software

TANSOFT

ultima ZONE

A 100% machine code space trilogy—shoot the Waikons, avoid the bouncing Brunos, battle your way through the satellite zone. Requires 48k Oric.

£8.50

inc. V.A.T. post free

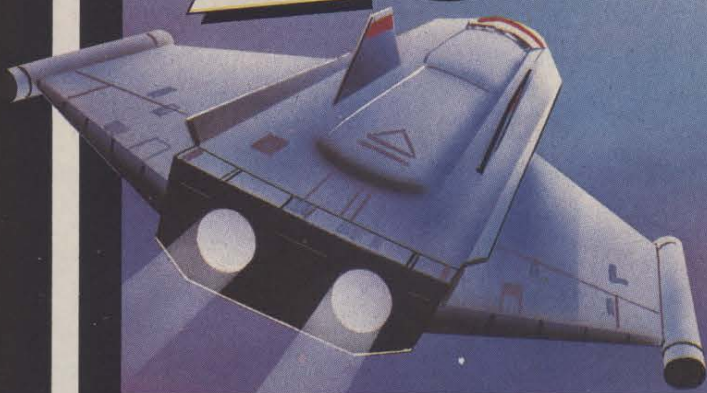

The HOBBIT

In co-operation
with
Melbourne House.

At last, this best selling adventure is available for the Oric based on J. R. R. Tolkien's book 'The Hobbit' (included) a complete text and graphics adventure. Requires 48k Oric.

£14.95

inc. V.A.T. post free



Our software is available from all Oric dealers and most good software suppliers. In case of difficulty please contact us on Teversham (02205) 2261 or write to us at:

TANSOFT

Unit 1 & 2, Techno Park, Newmarket Road, Cambridge

With 400 locations to explore, countless enemies to attack or avoid, 10 skill levels and hoards of golden coins to collect; Wumpus Hunt for the 48K Oric is sure to interest many users.

Graphically the game is neat but not really stunning (what d'ya expect with only three user defined graphic characters?). A 20 by 20 grid on the upper left-hand side takes up most of the screen. The three characters which are used signify your present location, locations already visited and unexplored locations. Along two sides of the grid is a scale, this enables the user to note hazardous locations to avoid or locations with items of possible use later on. The present location description and any action is displayed along the bottom 4 lines. And on the right-hand side are the important status numbers. They tell you your strength, weight and energy also the number of gold coins and objects you are carrying.

The aim of the game is to get in the same square as the Wumpus (not as easy as it sounds) and a battle is fought; the outcome depending on your strength (preferably high), your weight (preferably low), your energy (preferably high) and the amount of weaponry you're carrying (preferably high). Wumpus' sleep inducer also adds considerably to your chances of capturing the Wumpus. Then you must take it to the teleport station.

Wu

Controls

Q	to go North-West
A	to go West
Z	to go South-West
W	to go North
S	to Fight
X	to go South
E	to go North-East
D	to go East
C	to go South-East
	to look at Inventory
J	to Drop something
O	to Open box (with key)
K	to use Strength
P	to Quit
L	to Get something



Wumpus Hunt

Runs on
48K Oric

The Game

The level of difficulty determines the number of friendly and unfriendly people. Only friendly people will sell items. An unfriendly person can (and usually will) attack you. Bats are harmless but superbats certainly aren't. Zombies wander around the place stealing objects and being unhelpful if possible. Giant spiders can, if in the mood, entangle you in a web.

Sometimes tramps will sell food, wizards will sell some potent elixer, elves will sell keys and some warriors will sell swords, daggers, helmets, shields and suits of armour.

A substantial number of locked boxes are to be found in the Land of the Wild Wumpus. If you can open these boxes,

some of the things which you'll find are: food, daggers, swords (short), armour, keys, gold coins, black disks, bags of marbles, tins of superbat repellent(!) and Wumpus sleep inducer.

A box can be opened in two ways, with conventional keys or by using strength.

The boxes in this wondrous land are rather unusual. For a start the lock eats the keys when they have opened the box. This means that the key can open only one box before it's useless, in way of recompense the locks 'll eat any ol' key, so every key will open any box.

Also the boxes are sensitive to extreme pressures. If your total energy and strength is too high the box will positively refuse to open and will even threaten to blow the square sky high. Using strength to open boxes will decrease your strength by 1 each time, the boxes won't always spring open either.

Also featuring in this game of course and cunning are several neutral locations. Swampy, rocky and hilly grounds are common. Fans of 'A Country Practice' will recognise a fat little Wombat which crawls about.

After a few turns you may have noticed that your energy points have decreased. No, it isn't a bug, your Wumpus hunting warrior is probably getting hungry! To increase your energy points, you use the 'get' command on food, or buy it from somebody.

Scoring

For every person killed, you get between 20 and 29 points. Each item that you carry is worth a certain number of points between 2 and 30. The number of gold coins in your possession adds that number to your score. If you manage to capture the Wumpus, you get 1000 points for each man left.

Hints to Play

It may seem impossible to win the battles at first, the idea is to get some weapons then go off on a killing spree. Don't just go around collecting gold coins either, you're not there to steal the country's money. Anyway, it will just increase your weight until you can't get the Wumpus, the Wumpus is your real target.

When you arrive in a square occupied

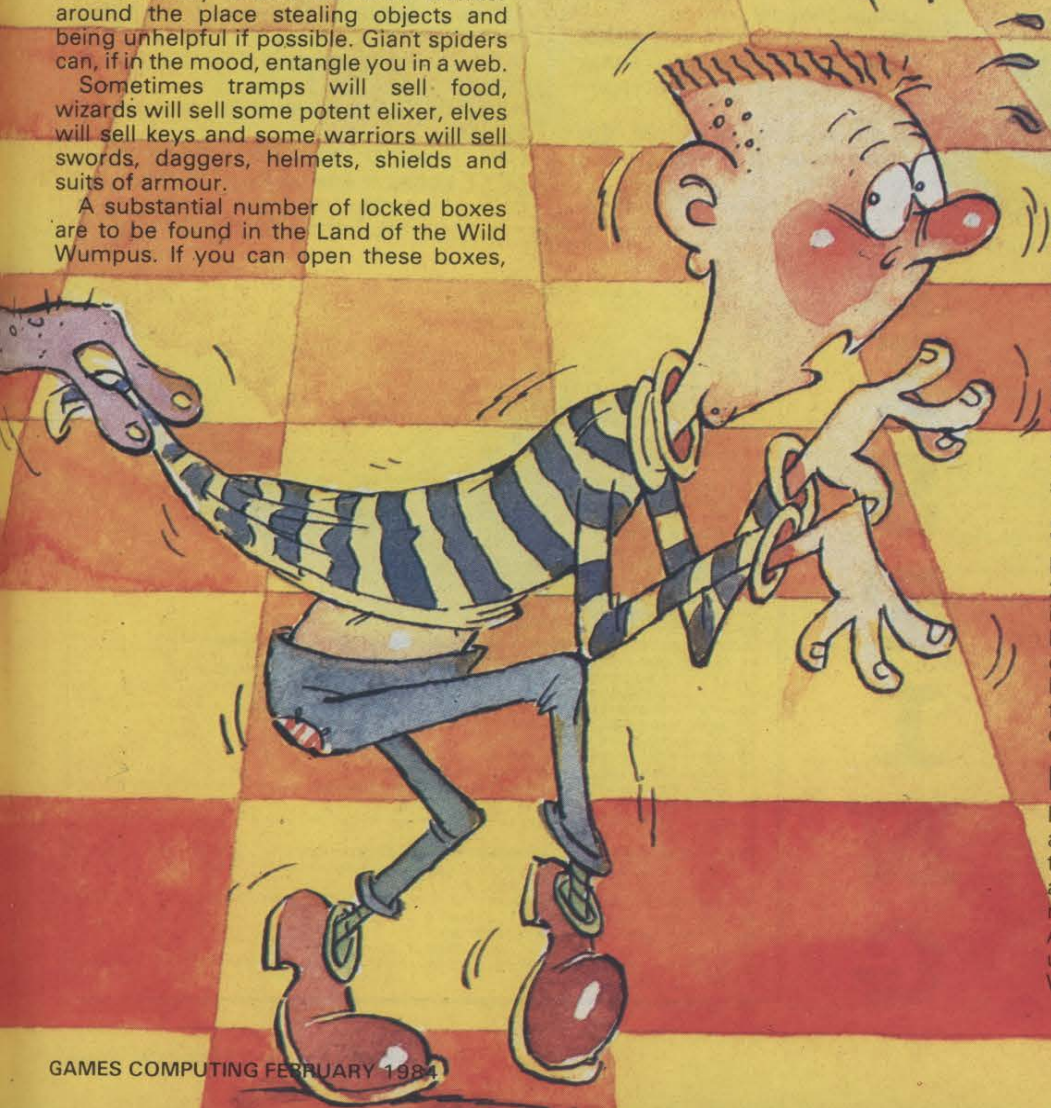

by a hostile person or creature, quickly press the attack key or exit the square. Pressing the attack key before they attack gives you an advantage. Attacking a friendly person gives them an advantage and if you don't kill them, they turn into unfriendly people.

Every object in the game has a purpose. Think about it and you could get a welcome surprise.

RUNdown

Line	Action
1-16	DIMensioning arrays, initialisation, GOTO 1500.
19-44	Main checking routines, updates display, GOTO 110.
70-100	Setting up display routine, used once per game.
110-138	Update location description, jumps to various sections.
144-148	Secondary checking routine.
150-192	Input section, inputs checked and processed.
200-202	Grizzly bear got you routine, jump to escape routine.
210-212	Caught in spiders web routine.
220-234	Escape routine.
240-244	Bottomless pit routine.
246-248	Life lost routine.
260	Tramp sell data.
270-288	Warrior sell data.
300-302	Wizard sell data.
310-312	Elves sell data.
320-348	Sell routine for sell data.
360-385	Fighting routine, jump to life lost routine.
390-422	Wumpus capture routine.
450-456	Inventory routine.
470-504	Drop object routine.
508-546	Get object routine.
570-592	Open with key routine (box).
620-634	Open with strength routine (box).
700-706	Quit routine.
800-824	Game over routine, jump to little page routine.
850-880	Return to teleport station with Wumpus routine.
1000-1002	Clear bottom 4 lines routine. Most routines jump here.
1500-1554	Initialisation of descriptions of locations.
1560-1570	Initialisation of descriptions of contents of boxes.
1580-1590	Redefining characters for display.
1600-1620	Initialisation of various values for objects.
1640-1642	Initialisation of words used in fighting routine.
1700-1720	Title page and tune.
1800-1816	Input skill level, reset variables.
1830-1885	Loops for locating different locations.
2000-2016	Locating different locations.
2100-2122	Putting objects in locations routine.

If you find that the fighting routine is too easy or hard, the IF... THEN statement in line 376 should be altered.

Lines 402 and 404 control the Wumpus capture routine. Line 627 controls the chance of a box exploding. Every time you are required to input something, a PING is heard. If this system proves too noisy, the relevant lines can easily be altered.

Variables Used

A1	Holds values for different locations. Values 0 to 33.
(19,19,0)	Values 0 or 1.
B%	Number of objects in location. Last number corresponds

to inventory number. Values 0 to various.

C\$ (33)	Descriptions of locations.
D\$ (33)	Descriptions of locations.
S,S\$	Strength value, in numeric and string form.
W,W\$	Weigh values, in numeric and string form.
F,F\$	Energy value, in numeric and string form.
O,O\$	Number of objects, in numeric and string form.
G,G\$	Number of gold coins, in numeric and string forms.
L%	Number of lives left.
P% (6)	Objects which you carry, in numeric form.
P\$ (6)	Objects which you carry, in string form.
P1% (6)	Total number of each kind of object possible to carry.
P1\$ (6)	Description of each object for inventory.
P2% (9)	Value of each item for score.
K\$ (9)	Descriptions of objects for search.
W1 (9)	Weight of objects, for adding to initial weight (or deducting).
L1\$ (9)	Words for fights.
E\$ (9)	Objects in locked boxes, string form (descriptions).
X%,Y%	Co-ordinates for plotting your present location.
Q%,R%	Co-ordinates for plotting locations already visited.
H,H\$	High score, in numeric and string form.
N\$	Name of high score holder.
B	Skill level input.
I\$	General input, as the main input it is in a I\$=KEY\$ form.
E%	Timer on input.
U2	Enemy advantage when you attack friendly people.
U1	Your advantage if you attack first, increases if you attack superbats with superbat repellent.
U%	If the Wumpus is caught, this has a value of 1, else it has a value of 0.
K%	Numerical value of location,

S%	Points for killings count, added to other counts for score.
Y1	Escaping from grizzly, once caught you don't get caught again there.
Y2	Escaping from giant spiders web, so that once escaped from web you don't get caught in that one again.
C1%	NUMBER for escaping grizzly or web.
C2	Number for escaping grizzly or web.
E1	Weight of object for buying routine.
D3%,D2%,C1%	Numbers for calculating price of objects sold.
KA,KC	The two numbers that determine if you have captured the Wumpus when you attack it.

Conversion Clues

This program should be fairly easy to convert to other micros, most of it is written in near standard BASIC. Non specific REMs split up the sections or routines.

The screen size of the ORIC is 27 rows by 38 columns. The command PLOT X,Y,Z, is used for plotting. Where X is the column (values 1 to 38), Y is the row (values 0 to 26) and Z is a string (Z\$) or an attribute. When the value of Z is between 0 and 7 the attribute alters the foreground colour from the X,Y co-ordinates to the end of the line. When the value of Z is between 8 and 15, the character set used (single height, double height, standard set, alternative set, flashing or steady) is changed from the X,Y co-ordinate to the end of the line. When the value of the attribute is between 16 and 23, the background colour from the X,Y co-ordinate to the end of the line is altered. PLOT 1,0 "Hi" produces Hi in the top left corner. XX=FRE(" ") forces variable garbage collection. FOR T=48000 TO 48039: POKE T,22: NEXT pokes a line of cyan background colour along the top of the screen.

LISTING

```

1 REM
2 REM
3 REM
4 REM      WUMPUS HUNT
5 REM
6 REM      by D.T.Wright
7 REM
8 REM
9 REM
10 PRINTCHR$(17)CHR$(6):POKE48035,0
12 DIMA1(19,19,1),B%(19,19,9),C$(33),D$(33)
14 N$="First game":H$="000":INK2:PAPER0
16 GOTO1500
18 REM-----
19 Y1=0:Y2=0
20 F=F-.15
21 WAIT60:IFF<4THENS=S-.2
22 IFW>18THENS=S-.2
23 IFS<0THEN246
24 G=INT(G)
25 IFF>16THENS=S+1
26 IFS>20THENS=20
27 IFF>20THENF=20
28 IFF<0THEN246
30 G$=STR$(G):W$=STR$(W):S$=STR$(S):O$=STR$(O):F$=STR$(F)
31 GOSUB1000
32 IFY%>20THENY%=20
33 IFY%<1THENY%=1
34 IFX%>21THENX%=21
35 IFX%<2THENX%=2
36 K%=A1(X%-2,Y%-1,0):I$=""
38 FORT=0T07:F$(T)=STR$(F$(T)):NEXT
40 FORT=8T014:IFT=STHENNEXT
42 W$=LEFT$(W$,3):S$=LEFT$(S$,3):O$=LEFT$(O$,3):F$=LEFT$(F$,3)
44 GOTO110
49 REM-----
70 CLS:EXPLODE:FORT=48002T048039:POKET,22:NEXT
72 PLOT1,21,22:PLOT3,21,0:PLOT14,21,"WUMPUS HUNT"
74 FORT=1T03:PLOT24,T,6:NEXT
76 FORT=0T014:IFT=STHENNEXT
78 IFT=4ORT=6THENPLOT23,T,22:NEXT
80 IFT=14THENPLOT23,14,22:GOTO84
82 PLOT23,T,22:PLOT24,T,16:PLOT38,T,22:NEXT
84 PLOT26,1,"High-":PLOT30,2,"by":PLOT31,1,H$:PLOTINT(25+(12-LEN(N$))/2),3,N$

```

```

86 PLOT25,8,"Gold -":PLOT25,9,"Strength-":PLOT25,10,"Weight -
88 PLOT25,11,"Objects -":PLOT25,12,"Energy -":PLOT24,15,"KEY CONTR
OLS
90 PLOT23,16,"W=North P=QUIT":PLOT23,17,"X=South O=Open
92 PLOT23,18,"D=East L=Get":PLOT23,19,"A=West I=Invent
94 PLOT23,20,"S=Fight J=Drop":FORT=15T020:PLOT22,T,S:NEXT
96 FORT=2T021:FORT2=1T020:PLOTT,T,":NEXT:NEXT
98 FORT=0T09:PLOT1,T+1,48+T:NEXT:FORT=0T09:PLOT1,T+11,48+T:NEXT
100 FORT=2T021:PLOTT,0,65+(T-2):NEXT:K%=28
109 REM-----
110 PLOTINT((38-LEN(C#(K%)))/2),23,C#(K%):PLOT33,8,6#:PLOT34,9,S#:P
LOT34,10,W#
112 PLOTINT((38-LEN(D#(K%)))/2),24,D#(K%):PLOT34,11,0#:PLOT34,12,F#
-----
114 PLOT0%,R%, "+":PLOTX%,Y%, "":E%=0
116 Z=INT(RND(1)*5+B):IFZ<B+2THEN122
118 IFK%=1STHEN200
120 IFK%=21STHEN210
122 IFK%=23STHEN300
124 IFK%=19STHEN240
126 Z=INT(RND(1)*5+B):IFZ<B+3THEN136
128 IFK%=2STHEN270
130 IFK%=24STHEN300
132 IFK%=25STHEN310
134 IFK%=3STHEN260
136 IFK%=28STHEN850
138 GOTO150
144 WAIT200:GOSUB1000
145 FORT=8T012:PLOT34,T, " ":NEXT:E%=0
146 PLOTINT((38-LEN(C#(K%)))/2),23,C#(K%):PLOT33,8,6#:PLOT34,9,S#:P
LOT34,10,W#
148 PLOTINT((38-LEN(D#(K%)))/2),24,D#(K%):PLOT34,11,0#:PLOT34,12,F#
-----
150 U1=0:U2=0:I#=#KEY#:IFI#=""THEN#E%=E%+1ELSE160
152 IFE%>30ANDK%=16STHEN360
154 IFE%>18ANDK%=18STHEN360
156 IFE%>25ANDK%=20STHEN360
157 IFE%>125STHENEXPLODE:PLOT12,26,"GET A MOVE ON!":WAIT200:E%=0:G0
T0150
158 IFE%>35ANDK%=21STHEN360ELSE150
160 O#=#X#:R#=#Y#:I=0:XX=#FRE("")
162 IFI#="W"ORR#="w"THENY#=#Y%-1:GOTO19
164 IFI#="X"ORR#="x"THENY#=#Y%+1:GOTO19
166 IFI#="D"ORR#="d"THENX#=#X%+1:GOTO19
168 IFI#="A"ORR#="a"THENX#=#X%-1:GOTO19
170 IFI#="O"ORR#="o"THENX#=#X%-1:Y#=#Y%-1:GOTO19
172 IFI#="E"ORR#="e"THENX#=#X%+1:Y#=#Y%-1:GOTO19
174 IFI#="Z"ORR#="z"THENX#=#X%-1:Y#=#Y%+1:GOTO19
176 IFI#="C"ORR#="c"THENX#=#X%+1:Y#=#Y%+1:GOTO19
178 IFI#="I"ORR#="i"THEN450
180 IFI#="J"ORR#="j"THEN470
182 IFI#="S"ORR#="s"THENU1=1:GOTO361
184 IFI#="O"ORR#="o"THEN570
186 IFI#="L"ORR#="l"THEN500
188 IFI#="K"ORR#="k"THEN620
190 IFI#="P"ORR#="p"THEN700
192 PING:GOTO144
199 REM-----
200 IFY1=1THEN144
201 X=RND(1)*5:IFX>3.5STHEN202ELSE144
202 PLOT1,25," You really are in a mess now! ":C1%=5:C2%=2:C3=
2:GOTO220
209 REM-----
210 IFY2=1THEN144
211 X=RND(1)*5:IFX>4.3STHEN212ELSE144
212 PLOT1,25," He spins a massive web around you. ":C1%=6:C2%=3:C3=
2
219 REM-----
220 IFS>INT(RND(1)*C1%+B)THEN232
224 WAIT150:GOSUB1000
225 PLOT1,23," SELECT:strength points to escape.":PING:GETI#:I=VAL(
I#)
226 IFI<C1%ANDI<STHENS=S-I:F=F-1:GOTO229
227 IFS<2STHEN246ELSEIFS<ITHENPLOT14,26,"Too high!
228 GOTO224
229 IFI>INT(RND(1)*C2+C3)THEN232
230 PLOT3,26,"Hard cheese!You're still caught.":GOTO224
232 WAIT140:PLOT8,26,"Well done,you've escaped":WAIT150
233 IFC2=3STHENY2=1ELSEY1=1
234 GOTO20
239 REM-----
240 WAIT100:GOSUB1000
241 IFS=RND(1)*15+8:ITHENPLOT4,23,"Because of your strength you."ELSE
245
242 PLOT2,24,"grabbed hold of a branch and so a
244 PLOT8,25,"life hasn't been lost.":S=S-INT(RND(1)*3):GOTO144
245 A1(X%-2,Y%-1,0)=29
246 WAIT150:PLOT1,26,"...HARD CHEDDAR!YOU'VE LOST A LIFE...":L#=#L%-1
:S=18-B
248 F=18-B:IFL#>0THEN80ELSEWAIT160:U1=0:GOTO20
259 REM-----
260 PLOT1,25,"...The tramp offers you some food...":D2%=60:D3%=10:C
1%=9:GOTO320
269 REM-----
270 Z=INT(RND(1)*4):IFZ=0THENE1=1:C1%=0:D2%=30:D3%=20:GOTO260
272 IFZ=1THENE1=1:D2%=40:D3%=25:C1%=2:GOTO260
274 IFZ=2THENE1=1:D2%=50:D3%=15:C1%=1:GOTO260
276 IFZ=3THENE1=1:D2%=38:D3%=70:C1%=2:GOTO260
278 IFZ=4THENE1=1:D2%=45:D3%=26:C1%=2:GOTO260
280 PLOT1,26,"...They offer a fine golden sword...":GOTO320
282 PLOT1,26,"...A small round shield is offered...":GOTO320
284 PLOT1,26,"...They offer a Stay-Sharp (TM) dagger.":GOTO320
286 PLOT1,26,"A suit of royal chain mail is offered":GOTO320
288 PLOT1,26,"...They toss a slightly dented helmet...":GOTO320
299 REM-----
300 PLOT1,25,"...The Wizard offers you an elixer...":D2%=20:D3%=100
-----
302 PLOT1,26,"Which increases all of your powers...":C1%=10:GOTO320
309 REM-----
310 PLOT1,26,".....They have many keys to sell.....":D2%=50:D3%=11
312 C1%=3:EL=.15
319 REM-----
320 WAIT200:GOSUB1000
321 I=(INT((RND(1)*10)*(G/D2%))+D3%)

```

```

322 PLOT5,26,"and so asks for gold coins":PLOT17,26,STR#(I)
324 WAIT60:PING:PLOT1,25,"SELECT : (1) yes (A) Forget it buddy.":G
ETI#
325 PLOT1,26,"
326 IFL#="A"THEN144
328 IFL#="1"THEN350ELSE324
330 IFL#<0THENPLOT7,26,"You can't afford it.":GOTO144
332 IFC1%=9STHEN342
334 IFC1%=10STHEN346
144
338 IFW+E1>20THENPLOT6,26,"You can't carry any more.":GOTO144
339 IFC2%=70THENP#(C1%)=P#(C1%)+3:W+W+E1:O=O+3:G=6-I:GOTO20
340 W+W+E1:O=O+1:P#(C1%)=P#(C1%)+1:O=O-I:GOTO20
342 IFF>18STHENPLOT3,26,"Greedy pig!You've already eaten.":GOTO144
344 F+F+2:G=6-I:G=5+5:GOTO544
346 FORT=1T012:MUSIC1,3,T,0:PLAY1,0,1,1000:WAIT30-T:NEXT:PLAY0,0,0,
0
348 G=6-I:S=5+6:F=F+6:W=W-4:GOTO20
359 REM-----
360 PLOT1,22,"Unfortunately you have been attacked,"
361 IFK%=25STHENPLOT1,26,"ELF BASHER!They're an endangered lot!":S=S
-1:GOTO144
362 IFK%=24STHENPLOT1,25,"The Wizard roars.Do you dare to attack"ELS
E364
363 PLOT1,26,"me?With one wave,he destroys you....":WAIT300:EXPLOD
E:GOTO246
364 IFK%=00R#=#X%+10R#=#X%+40R#=#X%+150R#=#X%+220R#=#X%+260R#=#X%+270R#=#X%+280R#=#X%+290R#
=#X%+31STHEN369
365 IFK%=30STHENPLOT7,26,"STOP TRYING TO RUB IT IN":GOTO144ELSEIFK%=
33STHEN369
366 FORT=5T014:IFK%=TTHENPLOT10,26,"I HOPE YOU'RE WELL.":GOTO144ELSE
NEXT
367 IFK%=20R#=#X%+30R#=#X%+32STHENPLOT10,26,"THAT WASN'T WISE":A1(X%-2,Y%-
1,0)=1:U2=1
368 GOTO370
369 PLOT6,26,"NOTHING TO ATTACK ERROR.":GOTO144
370 WAIT100:GOSUB1000:PLOT4,23,"SELECT:strength points to attack":P
ING:GETI#
371 I=VAL(I#):IFS<1STHEN246ELSEIF(I<SANDI<SANDI<0)THENS=S-I:GOTO372ELS
E370
372 WAIT60:GOSUB1000:FORT=1T06:Z1=INT(RND(1)*9):Z2=INT(RND(1)*25+5)
373 Z3=INT(RND(1)*4+22):PLOT22,Z3,L#(Z1):MUSIC1,0,T,0
374 PLAY1,0,4,1000:WAIT60-T*3:PLOT2,23," ":NEXT:PLAY0,0,0,
0
375 IFK%=18ANDP#(5)>0THENU1=U1+1
376 IFI+P#(0)+P#(1)/2+P#(2)+(16-W)+U1>RND(1)*10+6+U2STHEN381
377 PLOT2,24,"Unfortunately you have been beaten.":I=INT(RND(1)*S+
F):WAIT100
378 IFI<15STHENPLOT8,25,"In fact you're now dead...":WAIT60:GOTO246
379 I=INT(RND(1)*4):PLOT3,26,"You have lost strength points.
380 PLOT16,26,STR#(I):S=S-I:U1=0:WAIT199:GOTO20
381 PLOT1,25,"You are victorious!The foe are beaten":I=INT(RND(1)*2
)
382 L=INT(RND(1)*10+2):S=S-I:PLOT3,26,"You have lost strength poi
nts.
383 PLOT16,26,STR#(I):WAIT200:PLOT3,26,"You have found gold coin
s....
384 PLOT17,26,STR#(I):G=L:A1(X%-2,Y%-1,1)=1:A1(X%-2,Y%-1,0)=30:WA
IT99
385 O=0+1:U1=0:S#=#X%+20+B:GOTO20
389 REM-----
390 WAIT60:PLOT1,23," QUICK! PRESS A KEY ":E%=0
392 I#=#KEY#:IFI#=""THEN#E%=E%+1ELSE396
394 IFE%>20STHEN414ELSE392
396 PLOT1,24,"SELECT : strength points to attack.":PING:GETI#:ZAP:W
AIT100
398 I=VAL(I#):IFI<SANDI<0STHEN399ELSE396
399 IFS<2STHEN246
400 IFL>STHEN396
402 K=I+P#(0)+P#(1)/2+P#(2)+P#(3)*2+(16-W)+RND(1)*3
404 KC=RND(1)*5+RND(1)*5+10:S=S-1
406 IFL#<0STHEN414
408 PLOT4,25,"You have captured the Wumpus!":WAIT60
410 PLOT1,26,"Now you must take it to civilisation":U#=#U+1
412 A1(X%-2,Y%-1,0)=32:GOTO144
414 PLOT7,25,"The Wumpus has escaped!
416 PLOT6,26,"And has stolen some gold!":G=INT(G-((G/30)*B+1))
418 X=INT(RND(1)*19):Y=INT(RND(1)*19)
420 IFA1(X,Y,0)<>2BTHENA1(X,Y,0)=23:A1(X%-2,Y%-1,0)=32ELSE418
422 WAIT150:GOTO20
449 REM-----
450 GOSUB1000:IFK%=17DR#=#X%+16STHENPLOT7,26,"You are told to sod off!
":GOTO144
451 X=RND(1)*3:IFX<1STHENPLOT3,25,"Unfortunately a ZOMBIE chases you
"ELSE453
452 PLOT7,26,"and you have to move away":GOTO144
453 PLOT14,22,"INVENTORY":FORT=0T07:PLOT6,24,P1#(T)
454 PLOT1,24,STR#(T):PLOT3,24,")
455 PLOT27,24,P#(T):PING:PLOT12,26,"PRESS ANY KEY
456 GETI#:NEXT:GOTO144
469 REM-----
470 WAIT150:GOSUB1000:IFK%=17STHENPLOT5,26,"The tramp doesn't like y
ou":GOTO144
471 PLOT13,22,"DROP OBJECT":PLOT1,24,"SELECT : object number (A)fo
rget":PING
472 GETI#:PLOT13,26,"Selected":PLOT23,26,I#:IFI#="A"ORR#="a"THEN144
ELSEWAIT120
473 I=VAL(I#):PLOT10,26,P1#(I):IFI<8STHEN474ELSEPLOT13,26,"
":GOTO471
474 IFP#(I)<1STHENPLOT1,26,"You cannot drop what you don't have":GOT
O470
475 X=INT(RND(1)*15+B):IFX>13STHENO=0-1:P#(I)=P#(I)-1ELSE477
476 PLOT1,26,"A Zombie takes the object and eats it!":WAIT150:GOTO2
0
477 FORT=5T014:IFA1(X%-2,Y%-1,1)=0ANDK%=TTHEN478ELSENEXT:GOTO480
478 PLOT2,26,"A naughty elf takes the object and
479 WAIT200:PLOT6,26,"has put it in a locked box":GOTO483
480 IFI=5ANDK%=25STHEN490
481 IFI=6ANDK%=24STHEN500
482 A1(X%-2,Y%-1,1)=1
483 W=W-P1(I):O=O-1:P#(I)=P#(I)-1
484 B#(X%-2,Y%-1,1)=B#(X%-2,Y%-1,1)+1:GOTO20
490 PLOT1,23," The elves gladly take the gift":S=S+3
492 PLOT1,24," They give you 2 strength pills which
494 PLOT1,25," increases your strength by three.
496 W=W-1:O=O-1:P#(I)=P#(I)-1:WAIT300:GOTO20
500 PLOT1,23," Well done,the Wizard can now use his
502 PLOT1,24," Apple.He gives you 200 gold coins
504 PLOT1,25," and a weight reduction pill.":G=6+200:GOTO496
507 REM-----

```

```

508 GOSUB1000:IFK%=170RK%=16THENPLOT7,26,"You are told to clear off
":GOTO144
509 PLOT14,22,"GET OBJECT":PLOT6,26,"Do you want to search Y/N":PIN
B
510 GETI#:IFI#="Y"THENPLOT3,23,"These are the objects in the area."
ELSE515
511 FORT=5T014:IFK%=TTHENPLOT3,26,"Do you think I have X-ray eyes?"
:GOTO144
512 NEXT
513 FORT=0T09:PLOT1,24,STR$(T):PLOT3,24,"":PLOT6,24,K#(T)
514 PLOT27,24,STR$(B%(X%-2,Y%-1,T)):PING:PLOT12,25,"PRESS ANY KEY."
:GETI#:NEXT
515 IFAI(X%-2,Y%-1,1)=0THENPLOT3,26," This box is locked
":GOTO144
516 WAIT100:GOSUB1000:PLOT1,26,"SELECT :number of object (A)leave
it
517 PLOT12,25," "":PING:GETI#:IFI#="A"ORI#="a"THEN144
518 PLOT1,26," "":I=VAL(I#)
519 IFI<10THEN520ELSE515
520 IFB%(X%-2,Y%-1,1)<1THENPLOT7,26,"Sorry,none of those here.":GOT
0515
522 IFW+W1(I)>20THENPLOT7,26,"You can't carry any more.":GOT0515
524 IFP%(I)=P1%(I)THENPLOT7,26,"Can't carry more of them.":GOT0515
527 IFI=8THEN0=0+1:GOT0540ELSE0=0+1
528 IFI=9THEN536
532 B%(X%-2,Y%-1,1)=B%(X%-2,Y%-1,1)-1:W=W+W1(I)
533 FORT=5T014:IFK%=TTHENA1(X%-2,Y%-1,0)=27ELSENEXT
534 IFK%=26THENA1(X%-2,Y%-1,0)=27
535 P%(I)=P%(I)+1:GOTO20
536 IFAI(X%-2,Y%-1,0)=26THEN6=6+32:A1(X%-2,Y%-1,0)=27:GOT0532
538 X=INT(RND(1)*20+10):G=6+X:A1(X%-2,Y%-1,0)=29:GOT0532
540 IFF<17THENPLOT4,26,"Greedy pig.You're not hungry.":GOTO20
542 F=F+1+RND(1)*2:W=W+W1(I):A1(X%-2,Y%-1,0)=27:S=S+.5
544 PLOT14,26,1:PLOT15,26,12:PLOT16,26,"CHOMP!":SOUND4,100,0:PLAY0,
1,4,1000
546 WAIT250:PLAY0,0,0,0:GOTO20
569 REM
-----
570 IFK%=260RK%=27THENPLOT6,26,"This box is already open.":GOT0144
571 IFK%=170RK%=16THENPLOT8,26,"You are told to go home.":GOT0144
572 FORT=5T014:IFK%=TTHEN576ELSENEXT
574 PLOT8,26,"No box here you twerp!":GOT0144
586 P%(3)=P%(3)-1:0=0-1
588 GOSUB1000
589 PLOT6,24,"The box springs open and ":MUSIC1,1,1,0:PLAY1,0,1,10
00
590 PLOTINT((38-LEN(E#(K%-5)))/2),25,E#(K%-5):A1(X%-2,Y%-1,1)=1:WAI
T60
592 A1(X%-2,Y%-1,0)=26:WAIT200:GOTO20
619 REM
-----
620 GOSUB1000:MUSIC1,1,1,0:PLAY1,1,1,2000:WAIT50
621 IFK%=260RK%=27THEN570
622 FORT=5T014:IFT=K%THEN624ELSENEXT
623 PLOT13,26,"No box here.":GOT0144
624 IFS<5THENPLOT5,26,"You are too weak to open it.":GOT0144
625 IFK%=260RK%=27THEN570
626 IFK%=170RK%=16THENPLOT9,26,"You must be joking":GOT0144
627 S=S-1:IFS+32-BTHENPLOT4,25,"The box groans,turns blue and"ELS
E630
628 PLOT1,26,"threatens to blow this place sky high":A1(X%-2,Y%-1,0
)=29:WAIT150
629 X=RND(1)*5+1:IFX<1.9THENEXPLODE:GOT0246ELSE20
630 X=RND(1)*2+1:IFX<1.5THEN634
632 GOT0588
634 PLOT1,26,"The box smirks,'try harder'it urges!":WAIT150:GOT020
699 REM
-----
700 GOSUB1000
702 PLOT1,23,"Do you really want to quit.....Y/N":PING:GETI#
704 IFI#="Y"ORI#="y"THEN800
706 IFI#="N"ORI#="n"THEN144ELSE702
799 REM
-----
800 GOSUB1000
802 PLOT1,23,12:PLOT15,24,"GAME OVER"
804 FORT=1T010:MUSIC1,2,T,0:MUSIC2,4,T+1,15
806 MUSIC3,4,12,0:PLAY2,2,7,1000:NEXT:PLAY0,0,0,0:WAIT100
807 I1=((S+F)-W/2)*10+6:FORT=0T09:I2=P2%(T)*P%(T):NEXT:I3=I1+I2+G+S
%
808 IFI3>HTHENPLOT7,24,"You have a high score -":PLOT32,24,STR$(I3)
ELSEB16
810 WAIT300:CLS:INPUT"Enter name then press <return>":N#
812 IFLen(N#)>12THENPING:GOT0810
814 H#STR$(INT(I3)):H=INT(I3):GOT0820
816 PLOT10,24,"Your score was -":PLOT26,25,STR$(I3):WAIT50
820 PLOT11,26,"Another game Y/N":PING:GETI#
821 FORT=4B000T049080:POKET,RND(1)*7+16:NEXT:WAIT300
822 IFI#="Y"ORI#="y"THEN1700
824 IFI#="N"ORI#="n"THENEXPLODE:CLS:ENDELSE820
849 REM
-----
850 IFAI(X%-2,Y%-1,0)=28ANDUX=1THEN852ELSE150
852 CLS:PLOT9,1,10:PLOT9,2,10:PLOT10,1,1:PLOT10,2,1
854 PLOT11,1,"CONGRATULATIONS":PLOT11,2,"CONGRATULATIONS
856 PLOT1,5,"The teleport machine whisks you home.
858 PLOT2,7,"The king thanks you for the Wumpus.
860 PLOT1,9,"And gives you 1000 gold coins per man
862 PLOT14,11,"surviving.":X=L%*1000
864 PLOT7,15,STR$(X):PLOT15,15,"GOLD COINS
866 G=6+X:T#="01090906040302010101050708060205020504030209"
868 FORT=1T044STEP2:T1=VAL(MID$(T#,T,2))
870 MUSIC1,3,T1,0:PLAY1,0,1,1000:WAIT100-T*2:NEXT
880 WAIT50:GOT0800
999 REM
-----
1000 FORT=22T026:PLOT1,T," "":N
EXT
1499 REM
-----
1500 FORT=0T04:READX#,Y#:C#(T)=X#:D#(T)=Y#:NEXT
1502 DATA"Disturbed by you,a group of BATS","flap harmlessly past.
1504 DATA"A few ROCKS litter the ground,no","gold here!
1506 DATA"You stumble across a group of","FRIENDLY WARRIORS.
1508 DATA"You meet a lonely and very","dirty TRAMP.
1510 DATA"Lucky blighter!You find a hoard","of GOLD COINS.
1512 FORT=5T014:C#(T)="You find a small but heavy,locked"
1514 D#(T)="BOX.":NEXT
1516 FORT=15T033:READX#,Y#:C#(T)=X#:D#(T)=Y#:NEXT
1518 DATA"A rather rude grizzly bear grabs you","and won't let go!
1520 DATA"You stumble upon a group of","UNFRIENDLY WARRIORS.
1522 DATA"You meet a dirty and nasty","UNFRIENDLY TRAMP.
1524 DATA"A squadron of attacking","SUPERBATS appear.

```

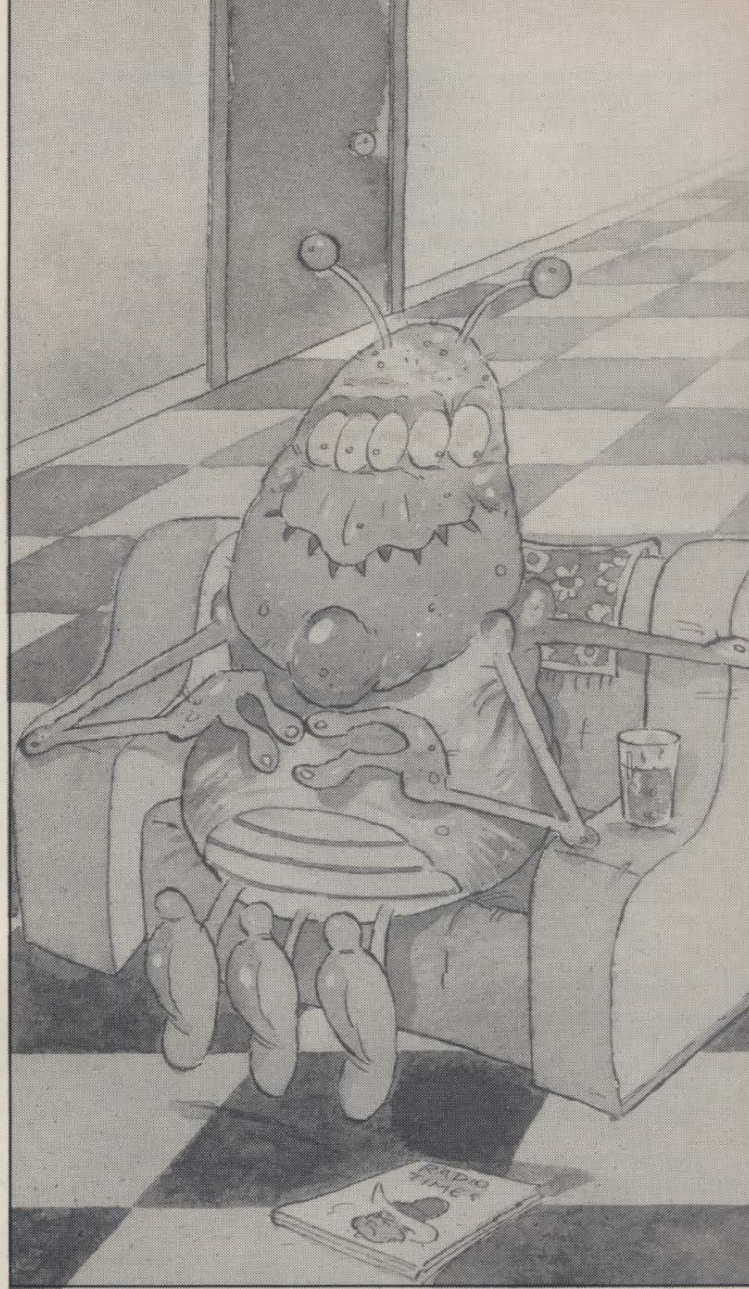

Wumpus

```

1526 DATA"You've fallen into a BOTTOMLESS","PIT < one life lost >.
1528 DATA"Three ZOMBIES amble towards","you.Watch out!
1530 DATA"A creepy GIANT-SPIDER scuttles","towards you.
1532 DATA"I smell a Wumpus!","A Wumpus is nearby.
1534 DATA"You've found the WUMPUS.":"It's starting to wake up.
1536 DATA"An old WIZARD with an","Apple approaches.
1538 DATA"Some small green ELVES","are playing here.
1540 DATA"A small and heavy box","lies open here.
1542 DATA"A small,heavy,open","and empty box is here.
1544 DATA"You are at the TELEPORT station in","the land of the Wild
Wumpus.
1546 DATA"Nothing of particular interest is","here.A wolf howls in
the hills.
1548 DATA"Several corpses litter the ground.":"A blue-headed Galah
calls you.
1550 DATA"You feel a sudden breeze.":"A bottomless pit is nearby.
1552 DATA"A big fat WOMBAT crawls to a bush.":"As he nears you hear
him fart!
1554 DATA"All around you is mushy swamp.":"Better get your wellies
on!
1559 REM

```

VIDEOZOO

Beating The Burger

Video games fans up and down the country last month took part in a special one-off competition playing Mattel Electronics Burgertime game to win a two week holiday in the fun and sun city of Florida.

Called the 1983 Mattel Electrolympics any readers of comics like Roy of the Rovers, Tiger, Eagle, Battle and 2,000 AD had to fill in a quiz relating to computer and video games. From the entries, which came in hundreds, 20 finalists were picked to take part in a play-off on Mattel's great new video game, Burgertime. And after a battle of nerves, skill and stamina 12 year old Malcolm Dickenson from Stockton-on-Tees came out on top as the winner.

So some time in 1984 he and his parents will be winging their way to Florida in America for a glorious two weeks of fun and frolics. The competition culminated in a London based contest which coincided with the launch of Mattel's new Burgertime cartridge. The organisers thought it would give all finalists a fair chance to play out the contest on a game which was brand new, so that video games addicts couldn't spend hours practicing the game. Burgertime is also Mattel's most popular new game at the moment and if you want to take a look at it the price tag is £19.95 from most Mattel stockists.

As well as giving away this super holiday Mattel also handed out Intellivision and Intellivoice units for the second and third prizes. In addition to consolation prizes of hand-held games for the runners up. So everybody went away with something in their hands! And on top of all that the finalists and their parents were taken off to have a huge hamburger meal complete with 'Burgertime' cocktails in London's trendy Covent Garden.

Beat the score

Idly playing away at one of Vectrex' new games somebody in our office notched up what has to be a record score on Mine Storm.

Chris 'video villain' Palmer not only scored over half a million points but also discovered screens that no-one knew existed. After having killed off hundred of aliens in the standard 25 screens he couldn't believe what was going on when he kept on going. They just kept

New Keyboard Comes At Last

More news on the Mattel front is that the firm's newest addition to its range of hardware is now on sale in a few shops.

The long-awaited Lucky Computer Keyboard is actually in production after what must now be a two year delay since the original announcement. Although *Games Computing* hasn't yet seen and tried out one of these we know that it will transform your Intellivision into a computer proper. This means that you will now be able to play not only video games on your machine, but also try out your hidden talents as computer programmers which was impossible until now. Maybe you are a brilliant computer games programmer and will reveal your skills when you plug your *Lucky Computer Keyboard* into your Intellivision?

It's now on sale for certain in London's 'shop for top people' Harrods (the shop with the big front in Knightsbridge) and that great toy shop which usually has everything you want, Hamleys in Regent Street. Unfortunately, the price of the new keyboard is quite high at £89.95. So that means you will be paying out around £200 for a full computer, with the Intellivision unit selling for about £100. Another new member of the Mattel family is the Music Keyboard which will suit people with an ear for a good tune. This too plugs into the Intellivision and is now on sale from a few shops for £69.95.

After Christmas Mattel plans to ensure the new keyboards will be on sale in many more shops on the same scale as the firm now sells its other Intellivision products. So keep your eye on your local supplier for the Lucky Computer Keyboards.

coming and coming! All told he counted a total of 37 screens before it all got too much for him and he ran out of lives. With the excitement of it all. Not before time either!

But not content with his word on the subject we decided to capture his score on film for ever, and that's what you see here! Out came the nearest camera with a roll of film inside and snap, snap we went, to keep the evidence.

But come on all you Mine Stormers

Looping

Runs on the Colecovision

Price £29.00

Here's a game that will keep you spinning topsy turvily all over your TV screen.

No matter what I did in Looping, my light aircraft kept crashing tragically into buildings, balloons, bullets and the runway. The first thing to do with this game is learn the mastery of manoeuvring your little blue plane around the screen and the obstacles plonked in your path by the meanie minded programmer who devised this game.

What's so confusing is that the joystick controller used for directional movement of the plane seems back to front. You have to pull the knob down to make the plane fly upwards and vice versa, while you are watching the plane from a sideways-on view. And that's why I kept crashing! Still, others who grabbed the joystick fared better than me so there's hope for everybody.

On the screen you'll see a gantry with its rocket, the runway and radar followed by some strategically placed buildings. To start the game you must make your plane take off, fly a loop and fire to destruct the rocket positioned at the left hand side of the screen. All this, of course, occurs after you have selected your skill level. While you are looping the loop all over the screen you must also shoot down blue balloons which fly through the sky. These craftily float up from the ground ready for you to bump into them — if any do, your plane will disappear with a big bang.

With a bit of luck and a lot of skill, having blown up the rocket you must do another loop and fly to the right of the

screen. On the far right hand side is a gate (but you can't see it at first) and this automatically opens when you destroy the rocket. You must navigate your plane, which incidentally sounds just like a radio controlled aeroplane, through the gate. Now this is a very tricky operation indeed but after a few attempts it gets easier, if that's any consolation. And here's the really infuriating part of the game.

Once safely through the gate you are suddenly confronted with a maze which you must fly through, and it's only possible to travel through it with precision flying. Your best course of action is to follow the path with the least number of tortuous twists and turns.

But even if you do master the navigational controls you are still not out of danger. There are green drops (on the higher skill levels) to dodge and twinkling monsters to shoot before you can make a timely exit from the pipe maze and enter the final phase of the game. First of all you pass into an outer room and you have to dodge or shoot the bouncing balls which appear all over the place. If you can do that you must try and dock your craft against the oblong right hand side of the inner wall. Once that's done, that's it, the game's over. And you start the game all over again.

Looping is difficult to play, and the Colecovision joysticks don't help matters. The actual object of the game in terms of addictive quality is not very clear, because there is no incentive to play again. The scenario is the same (except if you try the higher levels) on each level, and once you have docked your plane you just go right back to the beginning. As one colleague put it: 'There just aren't enough things to blow up in this game!' A bit morbid perhaps, but it's what is so often appealing in an arcade game.

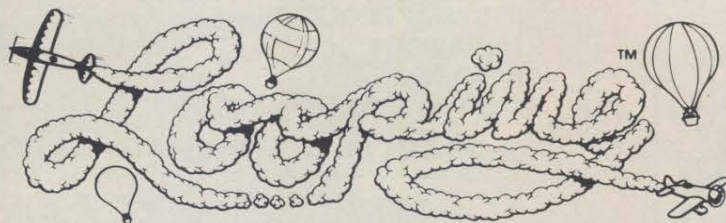

Pepper II

Runs on the Colevision

Price £29.00

Here's a great maze game which is simply and sufficiently different from the popular game of Pacman but is just as addictive to play.

Instead of darting you way round the paths of a maze you move your Pepper angel along the walls, or tracks, which make up the maze. When you have chosen your skill level you see the maze display on the screen. At first it looks complicated but once you've read the instruction booklet thoroughly and died a few times on the screen during

your first attempts all will beome clear.

The maze is designed to form 'rooms' walled by the paths of the maze. The manual refers to the walls as zipper tracks because the graphics display looks a bit like the teeth of a zip. The fun and frustration of Pepper II comes when you start zipping up the tracks. As you move your Pepper angel along the tracks they will change colour, from blue to pink. This means that you are on your way to earning some points. When you have zipped all the tracks enclosing a room you earn some points, but be careful where your angel treads because if he backtracks over a path he's already covered he in effect unzips the track. And that means the angel has to tread that way again.

And while you're desperately trying to work all that out, there are other things to get in your way. Particularly the roving eyes. These perform the same function as the ghosts you find in the game Pacman. They run around the tracks of the maze and if your Pepper angel bumps into one of them the angel is instantly devoured. And you lose one of your five lives (if playing on skill level one) or three lives (if on any other of the skill levels).

You'll notice that in some of the rooms of the maze are pitchforks. These are important because when you zip up one of these rooms it means that your angel's role is reversed and he can, for a few seconds, chase and eat the roving eyes — but you can only make a meal of them if they are coloured, and don't chance your luck too far because they have a nasty habit of reverting to their normal red colour just as you are about to eat one. Then *you* die instead.

Bonus points are up for grabs too, taking the form of safety pins or hammers. These are there for the taking if you enclose a room containing a bonus prize. In the centre of the maze is a room which sometimes contains a pitchfork and at other times contains a magic box. If you enclose this room and the magic box your angel turns into a pepper devil and you can once more eat up the roving eyes.

One particularly nasty character is the speedy green Zipper Ripper. He's only got one thing in mind and that's to unzip all the tracks round rooms that haven't been entirely enclosed. Another trick up his slimy green sleeve is that he can eliminate your pepper angel, if you are silly enough to let your angel get in contact with him.

And if you don't like the maze you start off in, you can travel into three other shaped mazes. To do this you must move your Pepper angel out one of the four exits located at the top, bottom, right and left of each maze. This automatically brings you onto one of the alternative mazes.

All said and done I found this game in the Colevision' range of recently released cartridges to be the most fun. Mainly because it was much easier to grasp the controls of the game, it was a novel idea containing a lot on-screen action and added little game play incentives, as well as providing comparative value for money (as far as these cartridge prices go). Also the controls in this game didn't prove to be too awkward, although sometimes was, if anything, too responsive.

out there. I think it's time young Chris was taken down a peg or two as he's getting a bit big for his boots now. Why don't you send us your Mine Storm high scores and beat that wopping score of Chris? Send all your offerings to: MINE STORM HIGH-SCORES, Games Computing, 1 Golden Square, London W1R 3AB.

We'll try and get to them before Chris does because he'll probably try and destroy them in defence of his own record!



From the people who really know.....

JOYSTICKS

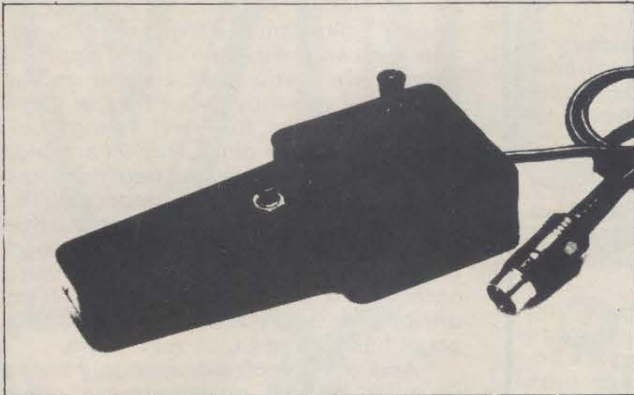

NOW AVAILABLE

Joysticks for:
Dragon
BBC
Tandy
Vic
Atari
ZX81
Spectrum etc.

Self centring microswitch joysticks in the same case as our popular pot types. Available with a variety of plugs to suit most popular micros, and interfaces (shortly) for, Spectrum and ZX 81, these light action precise mechanism give rapid, ultra reliable control of all your favourite games.

Ask at your local dealer or distributor, or in the event of any difficulty contact us direct.

Features: Compact size, precise action, long life, and competitive prices. Made in England by Flight Link, specialist manufacturers of joysticks for nearly 20 years.

UK and export enquiries invited



FLIGHT LINK CONTROL LTD

UNIT 12, THE MALTINGS, TURK STREET,
ALTON, HANTS
Telephone Alton (0420) 87241 Telex 858623 Telbur

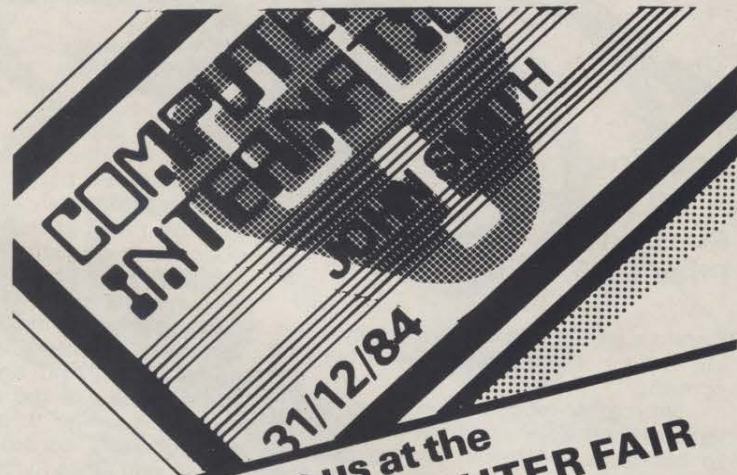

See us at the
NORTHERN COMPUTER FAIR
Belle Vue 24-26 Nov.

COMPUTER CLUB INTERNATIONAL

Reserve YOUR Membership today

CCI is a NEW COMPUTER CLUB specifically for you – the home computer enthusiast – whether or not you own a computer.

Members will enjoy a wide range of facilities, including their own magazine, regional meetings, contact with international members, exchange of software and many other benefits, all at very reasonable cost. Make sure of your membership reservation today.

Complete the coupon and send to –

Computer Club International
FREEPOST
(NO STAMP REQUIRED)
STALYBRIDGE
CHESHIRE
SK15 1YD

DO NOT SEND MONEY WITH COUPON

MEMBERSHIP RESERVATION

Please include my name on the CCI Membership Reservation List and send me further details without any obligation on my part to join.

SURNAME _____

FORENAME/S _____

ADDRESS _____

TOWN _____

COUNTY _____

POSTCODE _____

COMPUTER OWNED _____

ANCO SOFTWARE

25 Corsewall Street, Coatbridge

50 Super Arcade Games for your Sinclair Spectrum
DON'T BE FOLLED BY THE LOW PRICE!!

We are offering fifty exciting games for any Spectrum at a very special price. All the favourites are here: Pacman, Invaders, Frogger, Mastermind, 3D Maze, Surround, Aliens, Fruit Machine, Breakout, Stuntcycle, Asteroids, Submarine, Lunar Lander, Pontoon, Bomber, Escape, Connect 4, Helicopter, Treasure Hunt, Defender & 30 more fantastic games all with high resolution graphics and exciting arcade sounds.

WAS £8.99. SPECIAL OFFER PRICE ONLY £6.99.

50 GAMES FOR ZX81 only **£6.99**

10 GAMES FOR SPECTRUM ONLY **£3.00**

We also require Arcade Quality games for the Spectrum and will distribute them in U.K., Europe, United Arab Emirates and Australasia. Up to 50% Royalties paid for the best games.

Send your game at once for immediate attention.

Send cheques & PO's quickly to avoid disappointment to:

ANCO SOFTWARE

25 Corsewall Street, Coatbridge ML5 1PX

Free Adventure Game with every order (1 per household)

The world's first true 3D game.

Postern bring you the first fully
3 dimensional stereoscopic game.

by Mike Singleton

If you've escaped from
the Snake Pit, survived
The Siege, ridden the
mighty Shadowcat
and conquered the
fearsome Firehawks -
see if you're ready for
the ultimate experience.

POSTERN 

SPECTRUM
VIC 20
COMMODORE 64
BBC 'B'

£7.95

Postern Ltd. P.O. Box 2, Andoversford,
Cheltenham, Glos GL54 5SW.
Tel: Northleach (04516) 666
Telex 43269 Prestel 37745

This game requires a colour television set
and the special 3D glasses provided with each game.

© FRANK MOSES

ANIROG SOFTWARE

COMPUTER GAMES OF TOMORROW AVAILABLE NOW!

AS SEEN ON
T.V.!!



HEXPERT



MOON BUGGY



SKRAMBLE



3D TIME TREK

COMMODORE 64

NEW

GALAXY

AVOID CAPTURE BY THE ALIEN MOTHER SHIPS TRACTOR BEAM AS THE FIGHTERS DIVE BOMB YOU 100 SCREENS WITH A TWO PLAYER OPTION. K.B./J.S. £7.95

NEW APPROVED GAMES FOR
THE STACK LIGHT RIFLE

INDIAN ATTACK £5.95
COSMIC COMMANDO £5.95
VENGEANCE OF ZENO £5.95

- KONG** K.B./J.S. £7.95
4 SCREENS WITH BRILLIANT ANIMATED GRAPHICS
- SKRAMBLE** J.S. £7.95
6 SECTORS TO TEST YOUR SKILL
- HEXPERT** J.S. £7.95
TRAIN BERT TO BE HEXPERT ON THIS 3D HEXAGONAL PYRAMID
- MOON BUGGY** J.S. £7.95
MANOEUVRE YOUR PATROL CRAFT OVER GIANT POT HOLES AS YOU DEFEND THE MOON BUGGY FROM ALIEN ATTACK
- FROG RUN** K.B./J.S. £5.95
A POPULAR ARCADE GAME. FUN FOR THE WHOLE FAMILY
- 3D TIME TREK** K.B./J.S. £5.95
SPECTACULAR 3D GRAPHICS STAR TREK GAME
- DUNGEONS** K.B. £6.95
ENTER THE REALMS OF FANTASY IN THIS ROLE PLAYING GAME
- DARK DUNGEONS** K.B. £6.95
2ND IN THE SERIES OF FOUR. DEFINITELY NOT FOR THE FAINT HEARTED

24 HR. CREDIT CARD SALES HORLEY (02934) 6083
 PAYMENT BY CHEQUE, P.O., ACCESS/VISA
 8 HIGH STREET HORLEY, SURREY.
 Overseas 50p post & packaging
TRADE ENQUIRIES WELCOME
 29, West Hill, Dartford, Kent. (0322) 92513/8

As this is the first issue that will actually appear during 1984, we have given this month's puzzle page a distinctly Orwellian flavour.

BOOK OF THE YEAR

Below is an unusual crossword. We've made it easier by giving you all the answers — except one. Hidden in the grid is a pattern. Once the pattern is discovered, you should then find the book of the year.

O	N	B	U	S	A	F	U	N	D	I	T	C	H
B	E	E	N	A	D	I	R	G	E	E	Y	E	S
S	T	O	N	I	N	G	D	A	N	O	F	F	A
C	H	E	E	S	E	E	D	G	E	Y	O	U	R
P	O	T	A	S	H	N	I	G	H	T	A	N	D

A BRIGHT COLD DAY IN APRIL

Below is part of a very long sequence. Carry on with it for as long as you like.

WEAR IS PEACE

Said Orwell in '1984'. Can you make **SOFT** into **WARE** in three moves, changing just one letter at a time? Each change of course must be a recognisable word.

SOFT _____ WARE

TELESCREEN

Two words hidden below might enable a games person to play . . .

PLRIOSGTRIANMG

WINSTON SMITH

Is the hero's name in '1984'. What name is missing in the following sequence?

D J F M A M J _____?

DOUBLETHINK

"What is the price of one?"
 "Alf a quid."
 "How much for ten?"
 "That's a pound, guv."
 "I'll have two hundred and nine then."
 "That'll be thirty bob, guv!"
 What was he buying?

FALKOVIA RULES

Meanwhile, back in darkest Oceania . . . To keep up with his image of a cruel despot, the King of Falkovia recently imprisoned the three sons and three daughters of the good Duke Leslou, in the dungeons deep beneath the royal residence.

These dungeons consist of three cells, into which he placed the Duke's children. He labelled each cell as shown here — **MM**, **MF**, **FF** — **M** standing for male, **F** for female. Out of sheer spite however, although he put two children in each cell he made sure that in no cell did the label match the contents.

The King then challenged the Duke to devise where the 3 sons and three



daughters were disposed in the cells. Successful deduction would lead to their release. By candlelight the Duke was allowed to open one door at a time and



release one child. Of course in the murky gloom he would not be able to see who was left in the cell. And, need we add, there was a rule of absolute silence in dungeon.

In one of his periodic fits of clemency he allowed the Duke one free go — thereafter one child would be executed every time a cell door was opened. The Duke knew as much as you now know. How many children survived?

Next month — more eccentricities at court and more puzzles.

SOLUTIONS

1: Five Finger Exercise

NM
 (look at the bottom row of your typewriter/computer keyboard).

2: Peter Piper Picked a peck of pickled pepper.

3: $8 + 8 + 8 + 88 + 888 = 1000$.

4: You don't really need an answer for that do you?

5: We came up with 28 games — though we may have missed some. These are they —

Space Invaders, Frogger, Pacman, Lunar Lander, Asteroids, War Lords, Star Trek, Hangman, Breakout, Blockade, Chess, Galazians, Madness, Planet of Death, Dragons Lair, Golf, Parachute, Pinball, Pentrator, Car Wars, Forth, Maths, Life, Yan, Pools, Enigma, Dybug, Quest.

7: This is one of those problems which look utterly simple once you know the answer. It has very little to do with any computer except the one you keep between your ears.

The answer is C.

There is no particular trick to it. He looks at the man in front, as he must, and sees a white hat. He knows that he is wearing either a white or a black hat. He then reasons that if I

am wearing a white hat, the man behind will see two white hats and instantly deduce that he must have a black hat on. But the man behind is silent. He must therefore see a black and a white hat and be none the wiser. I am therefore wearing a black hat, says C, and is pardoned.

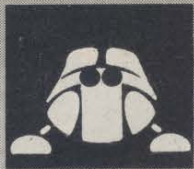
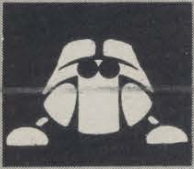

You are the last surviving defender of the planet GORGON. Your home planet is under attack by a fleet of aliens. The few survivors that are left depend on you!

When you run this program, a brief set of instructions will appear and it will wait for you to press the space bar. When you do the screen will clear and you will see the aliens together with your humble self at the bottom of the screen. To move your ship press 'Z' or 'X' and to fire press the space bar. If you manage to blast all the aliens before any of them reach the ground, another set of aliens will appear even closer to your ship.

When you are killed and your score is in the top 8 you will be asked to input your name. This can be anything up to 15 characters long (in fact the computer will not allow you to input anything longer) and when you do so the top 8 scores together with the

scores will be displayed. Press the space bar for another game.

Important

When you type in this program replace all £ by a hash character. This is absolutely essential.

RUNdown

Lines
Lines 1 to 3
Line 10

Line 20

Lines 30 to 40
Line 50

Lines 150 to 290
Lines 300 to 350

Lines 400 to 440

Action
REM statements.
Selects TEXT mode and resets HIMEM.
Defines arrays and print instructions.
Define variables.
Calls the main loop (the game itself).
Main loop.
Scan keyboard and take appropriate action.
Update missile position and print it.

Lines 500 to 540 This procedure is called when an alien is hit.
Lines 810 to 900 Set up the screen.
Lines 1000 to 1160 Print the instructions (called at line 20).
Lines 1250 to 1510 Redefine various characters.
Line 1610 Die.
Lines 1630 to 1710 Hall of fame.
Lines 1940 to 2060 Your score is in top 8.

Conversion Clues

Because this program is entirely written in BASIC and Oric BASIC is fairly standard, it should not be too difficult to convert this program to run on other machines but here are a few hints. The screen is 40 x 26
PLOT X,Y,A\$ is equivalent to PRINT TAB(X,Y)A\$ or PRINT AT X,Y,A\$. Ignore music statement or replace them with appropriate sound commands. CHR\$(4) is double height.

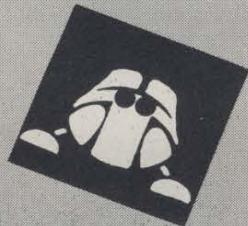
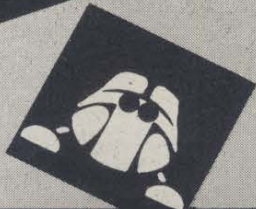
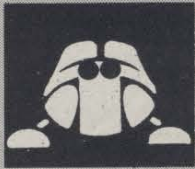
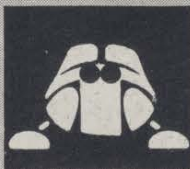

ALIEN DROPOU

```

1 REM ALIEN INVASION V2
2 REM Copyright (C) 1983 Oct.
3 REM By Shingo Sugiura
4 :
10 TEXT:GRAB:HIMEM#B400
20 DIM AL(36),SC(9),NA$(9):GOSUB1000
30 HE=4:SCz=0:LEz=0
40 GOSUB700:GOSUB810
50 GOSUB150
60 IF DIE THEN GOSUB 1610:GOTO30
70 GOTO40
144 :
145 REM Main loop
146 :
150 A=4:REPEAT
160 A=A+1:IF A>36 THEN A=4
170 GOSUB300
180 IF B=1 THEN GOSUB 400
190 IF AL(A)=0 OR RND(1)>.85 THEN GOTO 2
80
200 PLOT A,AL(A)," ":AL(A)=AL(A)+1:PLOTA
,AL(A),"?"
210 IF AL(A)>24 THEN DIE=TRUE
220 POKE616,0:POKE617,9:PRINTSCz
280 UNTIL DLz>32 OR DIE
290 RETURN

```

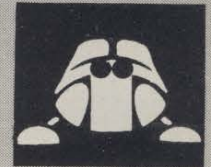

```

291 :
299 REM Scan keyboard
300 K$=KEY$
310 Xz=Xz+(K$="Z" AND Xz>3)
320 Xz=Xz-(K$="X" AND Xz<35)
330 IF K$=" " AN~ B=0 THEN MUSIC2,1,7,0:
PLAY2,0,1,500:BXz=Xz+1:BYz=
23:B=1
340 PLOTXz,24,SP$
350 RETURN
399 REM Move missile
400 PLOTBXz,BYz," ":BYz=BYz-1
410 IF SCRNBXz,BYz)<>32 THEN GOSUB 500
420 IF B=1 THEN PLOT BXz,BYz,"!"
430 IF BYz<3 THEN PLOT BXz,BYz," ":B=0
440 RETURN
499 REM Hit an alien
500 PLOT BXz,BYz,"*":ZAP
510 B=0:AL(BXz)=0
520 DLz=DLz+1:PLOT BXz,BYz," "
530 SCz=SCz+5
540 RETURN
699 REM Initialise
700 Xz=20:FLAG=0:DLz=0:SP$=" @ "
710 DIE=FALSE
800 RETURN
809 REM Set up the screen
810 CLS:HE=HE+2:LEz=LEz+1:IF HEz>=12 THE
N HEz=12
811 PLOT0, 5,17:PLOT0,26,18

```



**Runs on
48K Oric**

ALIEN DROPOUT

```
820 FOR A=0T01:PLOT0,A,20:PLOT38,A,23:NE
XT:PLOT1,0,1
830 PLOT2,0,"SCORE:" :PLOT20,0,"HI-SCORE"
831 H$=RIGHT$(STR$(SC(1)),LEN(STR$(SC(1)
))-1):PLOT29,0,H$
840 L$=RIGHT$(STR$(LE*),LEN(STR$(LE*))-1
):PLOT2,1,"SCREEN"+L$
850 FOR A=4 TO 36:Y=RND(1)*HE+LE*2:AL(A
)=Y:PLOTA,Y,"!":NEXT A
860 PLOT0,24,5:PLOTX*,24,SP$
870 FOR A=1T02
880 FOR B=1T012:MUSIC1,A,B,0:PLAY1,0,2,2
00:WAIT10
890 NEXTB,A
900 B=0:RETURN
999 REM Instructions
1000 CLS:PRINT
1010 PRINTCHR$(4)SPC(10);"ALIEN INVASION
";CHR$(4)
1020 PLOT1,1,10:PLOT1,2,10:PLOT0,1,CHR$(
5):PLOT0,2,CHR$(5)
1030 PRINT:PRINT:PRINTSPC(9);"By Shingo
Sugiura":PLOT0,4,CHR$(1)
1040 PRINT:PRINT" You are the sole defen
der of planet"
1050 PRINT"GORGON. All the others have b
een"
1060 PRINT"destroyed in the previous att
acks"
1070 PRINT"by the aliens. They attack in
rows so"
1080 PRINT"shooting them is easy, it's a
matter"
1090 PRINT"of shooting them all."
1100 PRINT" You must defend your home pl
anet as"
1110 PRINT"long as possible as the survi
vors"
```

```
1120 PRINT"depend on you."
1130 PRINT:PRINT"CONTROLS:-":PLOT0,16,CH
R$(4)
1140 PRINT:PRINT"'Z' --- :left."
1150 PRINT"'X' --- right."
1160 PRINT"SPACE --- fire."
1170 FOR A=46344 TO 46351:READB:POKEA,B:
NEXT A
1180 DATA33,18,30,63,45,63,18,45
1190 FOR A=46592 TO 46599:READB:POKEA,B:
NEXT A
1200 DATA0,12,12,12,45,63,45,63
1210 FOR A=47072 TO 47079:READB:POKEA,B:
NEXT A
1220 DATA0,8,8,8,8,8,8,0
1230 PRINT:PRINTSPC(5);CHR$(140);"Press
the SPACE BAR to play.":;PL
OT0,21,CHR$(2)
1240 REPEAT:UNTIL KEY$=" "
1250 FOR A=46616 TO 46623:READB:POKEA,B:
NEXT A
1260 DATA62,32,32,32,48,48,62,0
1270 FOR A=46632 TO 46639:READB:POKEA,B:
NEXTA
1280 DATA62,32,32,62,48,48,62,0
1290 FOR A=46656 TO 46671:READB:POKEA,B:
NEXT A
1300 DATA34,34,34,62,50,50,50,0
1310 DATA8,8,8,8,24,24,24,0
1320 FOR A=46704 TO 46719:READB:POKEA,B:
NEXT A
1330 DATA62,34,34,34,50,50,50,0
```



```

1340 DATA62,34,34,34,50,50,62,0
1350 FOR A=46736 TO 46751:READB:POKEA,B:
NEXT A
1360 DATA60,36,36,62,50,50,50,0
1370 DATA62,32,32,62,6,6,62,0
1380 FOR A=46464 TO 46543:READB:POKEA,B:
NEXT A
1390 DATA62,50,50,50,58,58,62,0
1400 DATA12,4,4,4,12,12,12,0
1410 DATA62,2,2,62,48,48,62,0
1420 DATA62,6,6,62,14,14,62,0
1430 DATA32,32,52,52,62,12,12,0
1440 DATA62,32,32,62,6,6,62,0
1450 DATA62,32,32,62,50,50,62,0
1460 DATA62,2,4,8,24,24,24,0
1470 DATA30,18,18,62,50,50,62,0
1480 DATA62,34,34,62,6,6,62,0
1490 DATA30,18,~8,62,50,50,50,0
1500 FOR A=46600 TO 46607:READB:POKEA,B:
NEXTA
1510 DATA30,18,18,62,50,50,50,0
1520 FOR A=0 TO 8
1530 SC(A)=120-A*10:NA$(A)="Shingosoft"
1540 NEXT A
1550 POKE#26A,10:RETURN
1610 EXPLODE:WAIT200
1620 CLS:GOSUB1900
1630 PRINT:PRINTCHR$(4)SPC(5);"ALIEN INU
ASION HALL OF FAME";CHR$(4)
1640 PLOT0,1,10:PLOT0,2,10:PLOT1,0,17:PL
OT1,1,17:PLOT1,2,17

```



```

1650 PLOT3,1,3:PLOT3,2,3:PRINT:PRINT:FOR
A=1 TO 8
1660 PLOT2,A*2+3,STR$(A)+".":PLOT8,A*2+3
,STR$(SC(A)):PLOT20,A*2+3,N
A$(A)
1670 PLOT8,A*2+3,1:PLOT19,A*2+3,4:NEXT
1680 PLOT5,24,"Press the SPACE BAR to re
play."
1690 PLOT4,24,12:PLOT1,24,6
1700 REPEAT:UNTIL KEY$=" "
1710 RETURN
1900 IF SC<=&SC(8) THEN RETURN
1910 FOR A=8 TO 1 STEP-1
1920 IF SC>>SC(A) THEN SC(A+1)=SC(A):F=A
:NA$(A+1)=NA$(A)
1930 NEXT:SC(F)=SC<
1931 REM Input name.
1940 PRINT:PRINT:PRINT:PRINTSPC(10)CHR$(
4)"!CONGRATULATIONS!"CHR$(4
)
1950 PLOT1,3,10:PLOT1,4,10:PLOT4,3 2:PLO
T4,4,2
1960 PRINT:PRINT:PRINTSPC(10)"Your score
of ";SC<
of ";SC<
1970 PRINT:PRINT"    qualifies for the Ha
ll of Fame."
1980 PRINT:PRINTSPC(8)"Please type your
name."
1990 PLOT11,15,"-----":N$=""
2000 REPEAT:GET A$
2010 IF ASC(A$)=127 AND LEN(N$)>1 THEN N
$=LEFT$(N$,LEN(N$)-1)
2020 IF ASC(A$)<>127 AND LEN(N$)<15 THEN
N$=N$+A$
2030 PLOT11,14,N$+" "
2040 UNTIL ASC(A$)=13
2050 NA$(F)=N$:CLS
2060 RETURN

```



19

WAR

From Rome To Ram — Setting The Scene

In the first article in this series I introduced you to the historical roots of computer wargaming. In this article I will be looking at some of the wider questions of wargaming on computers.

First, I must define the subject: what is a wargame? This is going to be controversial, so you will have to just accept what I say — after all, I'm the one writing this series! A wargame is a simulation of a conflict which has its origins in international politics. I thus exclude any simulation of a conflict between individuals, which I would put under the heading of role-playing. However, I am not excluding conflicts that stop short of shooting — such as our present Cold War. Others will disagree with me, but the categories I choose are not really important: what I will be discussing can be applied to a whole range of simulation games.

Why should we bother to computerise a wargame? After all, don't board games cover the files adequately? In traditional design there are features that occur repeatedly, and a look at these will show up the advantages and disadvantages of using a computer. I have identified four items to be considered. First, there is usually a board or playing area; this is divided into different terrains, and, in the case of the board game, is usually gridded with a square or hexagon pattern. Next, there are pieces representing military units of various sizes and strengths. There are rules governing the movement of the pieces on the playing area. And there

are rules governing conflict between the units of each player.

The strengths are usually indicated by numbers — so this is one area that the computer can work in. In fact this is an area where computers can improve on traditional wargames. There have always been compromises made on the recording of unit strengths to ensure that wargames don't become boring accounting exercises. With a computer it is possible to make step losses to units on a very fine scale — it would be possible to make man-by-man reductions to an army division if you so wanted!

With movement the advantage is less, but is still in the computer's favour. In board games the compromise is usually made of placing a grid over the play area to govern movement. This means that movement is always approximate. The computer can calculate distances much more accurately, and so can allow for more complex movement rules.

Off To Play

Combat is traditionally carried out by referring to a cross matrix of a die roll and an odds ratio of attack strength to defence strength (see figure. 1). This works fine with low numbers, but when large combat values are involved it can break down. For instance 300 attack factors against 10 defence factors would be 3-1; but 29 to 10 would be 2-1, a disproportionate drop. If given

an effective formula then 2.9-1 would be no problem for a computer.

That leaves us with the play area, and this is the big weakness of the computer. Most board games offer an area of about 50 cms by 50 cms, and over 5000 positions in that area. Some board games are over 100 cms by 100 cms, with about 25000 positions. Figure games are played in areas about 200 cms by 200 cms. A large TV screen offers about 40 cms by 30 cms, and an average home computer offers a useable on-screen area of about 800 positions. Of course, it is possible to split the play area so that only part is shown on screen at any one time, but this is a compromise.

There is one final area where the computer has an advantage over traditional wargames, and that is the 'fog of war' problem. In reality commanders have never had full information of their troops — units have been out of position, understrength, or close to breaking or to mutiny without the commander knowing. In traditional games this is virtually impossible to simulate because the commander has an eye-in-the-sky view of the battlefield. In computer games the computer is keeping records of unit strength, positions, etc, and it is possible for it to report somewhat falsely...

So those are the reasons for putting a wargame on the computer. But how to start going about it? First, you must choose your subject. There is a wide

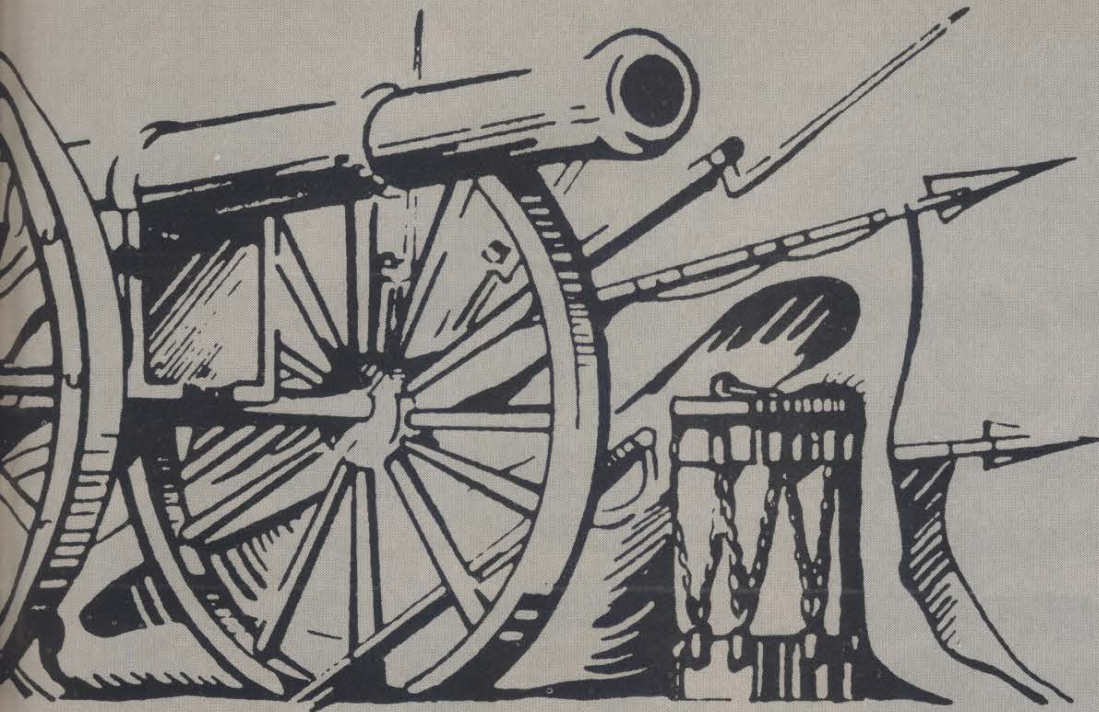

GAMES

84

range of possible subjects — mankind has been mixing it since there has been a mankind, and it is possible to see the situation continuing into the future.

Next, think about the scale of the game. You will have to consider the size of play area for the simulation, the size and number of fighting units in the game, and the timescale. These factors interrelate: World War II fought in 10 minute turns with platoon-strength units may prove a little long-winded and tedious. Another related problem here is the actual time it takes to play the game. To expect someone to sit down to play a game for up to two hours without a gamesave facility is just about reasonable. To expect a person to sit and play for 200 hours, with or without gamesave facility, is perhaps stretching it.

Other problems to be faced are: whether this is to be a game for one player, two players, or more; whether the computer is to be a moderator for the game or an active opponent; whether the computer is to be used as a backup to a board game or as the source for the entire game.

Often the subject matter chosen will dictate how the game is to be set up, and this brings me to me last big rule of wargame design: research. By this I don't just mean that to should research your subject area, although this is important. Look also at the best ways to represent the battles on the computer. Find the best formula to calculate battle

results, movement, etc. Remember, you are translating reality into a silicon chip. The magic occurs when the person who plays the game loses sight of that chip and gains a glimpse of reality.

Next Month: The problems of randomness and data storage.

Military Review: 'Empire', for the Dragon 32, published by Shards Software, price £6.95

This is a game for one player against a computer opponent (with a smattering of passive opponents thrown in). The basis of the game is that old board game favourite, Risk.

The game is played on a map of the World divided into thirty-nine provinces. At the start of the game thirteen of the provinces are neutral. You and the computer then alternately take provinces until all 39 are allocated.

Play proceeds in a series of turns, each turn following the same pattern. First computer (playing the Dragon Empire) places extra armies in its provinces. Then it attacks neighbouring provinces until it runs out of armies, runs out of provinces to attack, or is defeated in one of its attacks. Then it's our turn to place extra armies and carry out your attacks. The Neutrals never make attacks, although they do gain extra armies.

An attack is carried out by giving province from which the attack is to be

made and the province to be attacked. The battle will then proceed, each side losing forces until one side has been eliminated. The winning side can then move armies into the captures province. You can 'domino attack', that is attack a province, move in, attack again from the captures province, move in, until you run out of armies.

The computer wins by eliminating you from the game, you win by eliminating the computer. It is possible for either player to win without conquering the whole world as neutral donot affect victory.

The game plays very well, and can be completed in under one hour. The graphics are excellent: there is a map of the World and six area maps of each of the continents. A generous overlap on each of the area maps that you never suffer General Slim's problem of fighting battles on the edge of maps. There is sufficient noise to add to the excitement of play without making it sound like Pacman meets World War II.

There are nine levels of play, which dictate the attack strength of the Dragon Empire. They vary from 1, a doddle, through 9, a slaughter. Level 6 or 7 offers a very reasonable game with a strong opponent.

I can recommend this game as a good introduction to computer wargaming. It isn't so complex that it will put off the casual player, nor so simple that it will quickly pall. I have only one complaint: this game would work well on several computers, why has it only been published for the Dragon?





By D T Wright

Runs
on
Oric

Alien

They're back. A new evil race of aliens have taken it upon themselves to wipe out your city. You control the obligatory missile-launcher. With this you must wipe out the alien hordes. Your eyes anxiously look towards the sky, where you expect to see the foe any second now. Suddenly the sky is full of the most horrible, fearful and frightening creatures you have ever seen. The Alien Scouts have arrived. . . .

Firstly a wave Alien Scouts rapidly drop towards the city. If they land the city is doomed. You must act quickly.

Then the Mega-Bombs fall from the immense, unseen Command ship. Some hang; suspended by invisible Nyocrikle cords, waiting to fall. Others continue to fall, the ever-increasing noise designed to irritate rarely fails. Quick, help! BANG, a few parts of the city are destroyed.

And the third wave. . . You hear an evil noise, throbbing and threatening. The Saucers hurtle across the screen. A truly awesome sight. Seemingly harmless, their true intent — to supply the others, dawns upon you (usually too late). Although the city isn't likely to

be damaged, your defence couldn't survive the onslaught if the extra supplies were received.

If, by a remarkable feat of skill you survive all three waves; you get an extra life and bonus points. Then you must face them again, in a more powerful form.

Alien Scouts should work on a 16K Oric if the command GRAB is used and memory is cleared before starting.

Full instructions are included in the program. There are only four keys to use; left, right, fire, and pause. These

can be redefined within the program. The high score is displayed all the time with the name of the holder of it. Five skill levels are already incorporated into the program, but more easily be.

If you find this program too easily beaten, alter the numbers following the variables Y and E in the IF. . . THEN loops in the second and third waves. Raising the variable E increases the number of aliens which you must destroy before going onto the next wave. Lowering the variable Y lowers the number of aliens needed to kill you.

If you find that you cannot enter a line without it overflowing the two lines maximum, then enter the PRINT statements as? (question mark).

Rundown

- Lines 8-70
- Lines 100-110
- Lines 200-213
- Lines 300-322
- Lines 400-413
- Lines 1000-1032

Initialisation of control keys. Various jumps to: redefine characters, reset variables, instructions and the game. Control section, where inputs are processed. Movement and pause inputs are handled here. A jump to the firing routine is activated by the fire key.

The first wave of aliens. Various jumps to: control section, aliens landed section, sheet cleared section, set up display section.

The second wave of Aliens. various jumps to: life lost section, control section, set up display, sheet cleared section.

The third wave of aliens. Various jumps to: life lost section, sheet cleared section, control section, set up display section.

Firing routine.



Scouts

- Lines 2000-2090 Life lost section. Checks number of lives left. If you have no lives left, your score is checked against the high score. If this is greater than the high score you are asked to input your name.
- Lines 3000-3100 Sheet cleared section. A bonus is calculated and you are given it.
- Lines 4000-4130 Aliens landed section. This occurs when an alien scout lands. The game is over and a jump to the life section occurs.
- Lines 5000-5340 Set up display section. This produces the display complete with stars, score, high score, name of the high score holder, sheet number and different colour aliens.
- Lines 6000-6060 City destroyed section. This occurs when all of the cute red city has been destroyed.
- Lines 7000-7120 Cleared three waves section. This section is jumped to when all three waves have been cleared. A bonus is calculated and added to your points. An extra life is awarded. Then a jump to the first screen occurs.
- Lines 10000-10230 Instructions section. This requires you to input the skill level and checks if the present keyboard controls are O.K. If not, you have to redefine them. Jumps to the start of the program.
- Lines 15000-15260 Redefine characters section.
- Lines 20000-20030 Reset variables section. Jump to start of program.

Conversion Clues

This program is written entirely in BASIC so that it is easy to convert; and so that it can be modified or even improved.

A few points to remember about the Oric are:
 It has a screen size of 38 columns by 26 lines.
 There are 4 predefined sound commands; ZAP, SHOOT, EXPLODE and PING. The character is formed in a 6 by 8 grid (not 8 by 8 as in others).
 PRINT CHR (17) toggles the cursor on/off (same as CTRL Q).
 PRINT CHR (6) toggles the keyboard click on/off (same as CTRL F).
 A-FRE (""") forces variable garbage collection.
 When a plot command is followed by a number, the number is a serial attribute which controls the screen. Numbers from 0 to 7 alter the foreground colour for that point to the end of that line. Numbers from 8 to 15 change the character set that is printed (for example, the number 12 represents single height flashing characters). Numbers from 16 to 23 alter the background colour for that point to the end of the line.



```

8 REM -----
9 REM !
10 REM: ALIEN SCOUTS
11 REM:
12 REM:
13 REM: By D.T.Wright
14 REM:
15 REM:
20 CLEAR
30 DIMC(37):L$="1":R$="2":F$="\":N$="The Aliens":POKE48035,0:HS$="
00000"
33 FORI=1TO12:POKE48013+I,ASC(MID$(F$,"ALIEN SCOUTS",I,1)):NEXT
36 PRINTCHR$(6)CHR$(17):P$="P"
40 GOSUB10000
50 IFQ=0THENGOSUB15000
60 Q=1
65 GOSUB20000
70 GOTO200
97 REM-----
98 REM CONTROL
99 REM-----
100 IFI#=#R#THENX2=X1:X1=X1+1:IFX1=38THENX1=37
101 IFI#=#L#THENX2=X1:X1=X1-1:IFX1=1THENX1=2
102 IFI#=#F#THENGOSUB1000
103 IFI#=#P#THENGETI$:GOTO106
104 IFI#<>F#ANDI#<>L#ANDI#<>R#ANDI#<>P#THENRETURN
105 IFSCRN(X1,20)<>32ORSCRN(X1,21)<>32THEN2000
106 PLOTX1,20,"(":"PLOTX1,21,")"
107 PLOTX2,20," "
108 PLOTX2,21," "
109 PLOT10,24,SC#
110 RETURN
197 REM-----
198 REM ALIEN SCOUTS
199 REM-----
200 CLS:PLOT10,13,14:PLOT10,14,14
201 PLOT13,13,"Alien Scouts"
202 PLOT13,14,"Alien Scouts"
203 WAIT400:EXPLODE:X=19
204 GOSUB5000
206 BA=BA+F
207 IFA1=0THENPLOT10,INT(BA),CHR$(36):PLOT10,INT(BA-1)," "
208 IFA2=0THENPLOT15,INT(BA),CHR$(36):PLOT15,INT(BA-1)," "
209 IFA3=0THENPLOT20,INT(BA),CHR$(36):PLOT20,INT(BA-1)," "
210 IFA4=0THENPLOT25,INT(BA),CHR$(36):PLOT25,INT(BA-1)," "
211 IFINT(BA)>=22THENGOSUB4000
212 IFA1=1ANDA2=1ANDA3=1ANDA4=1THENGOSUB3000:GOTO300
213 I#=#KEY#:IFI#=""THEN206ELSEGOSUB100:GOTO206
297 REM-----
298 REM MEGA-BOMBS
299 REM-----
300 CLS:PLOT10,13,14:PLOT10,14,14
301 PLOT14,13,"Mega-Bombs"
302 PLOT14,14,"Mega-Bombs":Y=0
303 WAIT400:EXPLODE:X=18:GOSUB5000:I=316
304 ZZ=INT(RND(1)*28+6):Y=Y+1:IFZZ=X1-1ORZZ=X1+1ORZZ=X1+6THENI=315:
GOTO306
305 GOTO320
306 FORZ=8TO22STEP5K/2
307 PLOTZZ,Z,"*":PLOTZZ,Z-SK/2," "
308 MUSIC1,2,3,0:MUSIC2,4,Z/2,0:MUSIC3,3,10,0
309 SOUND4,5,0:PLAY7,0,1,1000
310 IFY>45-SK*2THENGOSUB2000
311 IFE>7+SKTHENGOSUB3000:GOTO400
312 IFZ>21THENSC=SC-15:SC#=#STR$(SC):PLOTZZ,Z,"":PLOT10,24,SC#
313 IFZ>21THENCD(ZZ)=1:Y=Y-1:PLOTZZ,Z+1,"":CD(ZZ-1)=1
314 GOTO1
315 WAIT10-SK:NEXT:PLAY0,0,0,0:I=316:GOTO304
316 I#=#KEY#:IFI#=""THEN315ELSEGOSUB100:GOTO304
320 ZX=(RND(1)*7)+(SK/3)
321 IFZX<=3.9THEN322ELSE306
322 I#=#KEY#:IFI#=""THEN306ELSEGOSUB100:GOTO304
397 REM-----
398 REM SAUCERS
399 REM-----
400 CLS:PLOT10,13,14:PLOT10,14,14
401 PLOT15,13,"Saucers"
402 PLOT15,14,"Saucers"
403 WAIT400:EXPLODE:X=22
404 GOSUB5000:Y=0
405 Z=INT(RND(1)*13+2):Y=Y+1
406 FORZZ=8TO36STEP1.5+SK
407 PLOTZZ,Z,"%":PLOTZZ-(1.5+SK),Z," "
408 MUSIC3,2,6,0:PLAY2,0,1,1000
409 WAIT10
410 IFY>12-SKTHENGOSUB2000

```

```

411 IFE>12+SKTHENGOSUB3000:GOTO7000
412 I#=#KEY#:IFI#=""THEN413ELSEGOSUB100
413 NEXT:PLOT34,Z,"":GOTO405
997 REM-----
998 REM FIRING ROUTINE
999 REM-----
1000 ZAP:FORT=20TO1STEP-1
1001 PLOTX1,T,"":PLOTX1,T+1," "
1002 IFSCRN(X1,T-1)=36ORSCRN(X1,T)=36THEN1010
1003 IFSCRN(X1,T-1)=38THEN1020
1004 IFSCRN(X1,T-1)=42THEN1030
1005 SOUND5,3,0:MUSIC1,2,5,0:PLAY1,2,2,1000
1006 NEXT:PLOTX1,1,"":RETURN
1010 SC=SC+SH*10:SC#=#STR$(SC)
1011 IFX1=10THENA1=1
1012 IFX1=15THENA2=1
1013 IFX1=20THENA3=1
1014 IFX1=25THENA4=1
1015 EXPLODE
1016 PLOTX1,T-1,"":PLOTX1,T,"":RETURN
1020 SC=SC+SH*20:SC#=#STR$(SC)
1021 EXPLODE:E=E+1:Y=Y-1
1022 PLOTX1,T-1,"":PLOTX1,T,"":RETURN
1030 SC=SC+SH*15:SC#=#STR$(SC)
1031 EXPLODE:E=E+1:Y=Y-1
1032 PLOTX1,T-1,"":PLOTX1,T,"":RETURN
1997 REM-----
1998 REM LIFE LOST
1999 REM-----
2000 CLS:PRINTCHR$(150)SPC(7)"SERIOUS ANNOUNCEMENT":LI=LI-1
2010 PRINT:PRINT"Due to mis-management you have lost a life."
2020 PRINT:PRINTSPC(5)"You have "LI:" lives left."
2030 IFLI=0THENPLOT14,15,"GAME OVER"ELSE2090
2035 WAIT300
2040 IFSC>HSTHENCLS:PRINTCHR$(149)SPC(10)"New high score"ELSE40
2050 PRINT:INPUT"Name(max.13 characters)":N$
2060 IFLN(N$)>13THENPRINT"...naughty":PING:WAIT20:GOTO2040
2070 PLOT5,20,6:PLOT6,20,"Press any key to continue...":GETA#
2075 HS#=#SC#
2080 GOTO40
2090 PLOT14,15,"Get ready":WAIT300:BA=4:GOTO200
2997 REM-----
2998 REM SHEET CLEARED
2999 REM-----
3000 CLS:PLOT10,15,10:PLOT10,16,10
3010 PLOT12,15,"Sheet":PLOT12,16,"Sheet"
3020 PLOT18,15,"Cleared":PLOT18,16,"Cleared"
3030 BO=SH*50+INT(RND(1)*50):SC=SC+BO:SC#=#STR$(SC):BO#=#STR$(BO)
3040 PLOT13,20,"Bonus "":PLOT20,20,BO#
3050 IFSC>3000ANDFM=0THENLI=LI+1:FM=1
3060 IFSC>15000ANDSM=0THENLI=LI+1:SM=1
3070 A1=0:A2=0:A3=0:A4=0:X1=14
3080 SH=SH+1:E=0:SH#=#STR$(SH)
3090 PLOT6,25,"Press any key to continue":GETA#
3100 RETURN
3997 REM-----
3998 REM ALIENS LANDED
3999 REM-----
4000 CLS
4010 FORY=1TO10
4020 EXPLODE:WAIT15+Y*5
4030 NEXT
4040 PRINTCHR$(150)SPC(7)"SERIOUS ANNOUNCEMENT"
4050 PRINT:PRINT"The aliens have landed,the city is"
4060 PRINT"doomed, flee while you can."
4070 PRINT:PRINT:FORT=1TO10
4080 PRINTSPC(13)"GAME OVER"
4090 NEXT
4100 PRINT:PRINTCHR$(131)SPC(4)"Press any key to continue":EXPLODE:
GETA#
4110 PRINT:PRINTSPC(9)"Your score was "":SC
4115 WAIT300
4120 IFSC>HSTHEN2040
4130 GOTO40
4997 REM-----
4998 REM SET UP DISPLAY
4999 REM-----
5000 CLS:SHOOT:WAIT100:INK5:CC=28
5010 PLOT1,0,X:PLOT1,23,X:PLOT1,26,X
5020 FORI=5TO33:IFCD(I)=1THENCC=CC-1:NEXT:GOTO5070
5025 IFCC=0THEN6000
5030 PLOT1,22,"/":NEXT
5070 FORT=1TO4
5080 PLOT1,T,2
5090 NEXT
5100 FORT=5TO8

```

Alien

Scouts

```
5110 PLOT1,T,3
5120 NEXT
5130 FORT=9T013
5140 PLOT1,T,6
5150 NEXT
5160 FORT=14T019
5170 PLOT1,T,5
5180 NEXT
5190 FORT=20T022
5200 PLOT1,T,1
5210 NEXT
5220 PLOT3,25,"High score : "
5230 PLOT17,25,HS#
5240 PLOT25,25,N#
5250 PLOT3,24,"Score : "
5260 PLOT17,24,"Sheet : "
5270 PLOT24,24,SH#
5280 PLOTX1,20,"(:PLOTX1,21,")"
5290 PLOT1,24,2
5300 FORT=1T035
5310 R=INT(RND(1)*36+1):S=INT(RND(1)*16+2)
5320 PLOT R,S,"":NEXT
5330 PLOT10,24,SC#I:A=FRE(" ")
5340 RETURN
5997 REM-----
5998 REM      CITY DESTROYED
5999 REM-----
6000 CLS
6010 FORT=1T010
6020 EXPLODE:WAIT15+Y*5
6030 NEXT
6040 PRINTCHR$(150)SPC(7)"SERIOUS ANNOUNCEMENT"
6050 PRINT:PRINTSPC(5)"Your city has been destroyed."
6060 GOTO4070
6997 REM-----
6998 REM      CLEARED 3 WAVES
6999 REM-----
7000 CLS:PRINTCHR$(146)
7010 PRINT:PRINTSPC(7)"Well done my son,you have"
7020 PRINT"defeated the alien hordes.Now they"
7030 PRINT"come in greater numbers and strength."
7040 PRINT:PRINT"To help you,a BONUS has been awarded."
7080 PRINT:PRINT".....an extra base,and,"
7090 PRINT".....500 extra points."
7100 SC=SC+500:SC#STR$(SC):LI=LI+1:BA=4
7110 P=P+.05:IFP>.6THENP=.6
7120 WAIT750:GOTO200
9997 REM-----
9998 REM      INSTRUCTIONS
9999 REM-----
10000 CLS:PAPER0:INK2:EXPLODE
10010 FORT=1T06:PRINTCHR$(128+T)SPC(6)"A L I E N   S C O U T S":WAIT
100
10020 EXPLODE:NEXT
10030 PLOT7,15,"Press any key to continue":GETA#
10040 CLS:PRINTCHR$(148)SPC(6)"I N S T R U C T I O N S"
10050 PRINT:PRINT"You control the last missile launcher"
10060 PRINT"of the Inter-Mega-Galactic star fleet"
```

```
10070 PRINT:PRINTCHR$(134)SPC(10)"YOUR MISSION"
10080 PRINT"To destroy the Alien Scouts before"
10090 PRINT"they land,and,if this happens,the"
10100 PRINT"game will end.You start with 1 life,"
10110 PRINT"but bonus lives will be awarded for"
10120 PRINT"meritorious performance."
10130 PRINT:PRINTCHR$(134)SPC(10)"YOUR CONTROLS"
10140 PRINT"To move right -":R#PRINT"To move left -":L#PRINT"To
fire -":F#
10145 PRINT"To pause -":P#
10150 PRINT:PRINTCHR$(131)"Are these keys O.K.-":GETA#
10160 IFA#="N"ORA#="n"ORA#="Y"ORA#="y"THEN10165ELSE10150
10165 IFA#="N"ORA#="n"THEN10170ELSE10210
10170 PRINT:PRINT"To move right -":GETR#
10180 PRINT"To move left -":GETL#
10190 PRINT"To fire -":GETF#
10195 PRINT"To pause -":GETP#
10200 IFR#=L#ORR#=#F#ORL#=#F#ORL#=#P#ORR#=#P#ORF#=#P#THEN10170ELSE10040
10210 PRINT:PRINTCHR$(131)"Select difficulty level(1-5,1=easy)-":G
ETSK#
10220 SK=VAL(SK#):IFSK<1ORSK>5ORSK<>INT(SK)THEN10210
10230 RETURN
14997 REM-----
14998 REM      RE-DEFINE CHARACTERS
14999 REM-----
15000 FORA1=46368T046375
15010 READB1:POKEA1,B1:NEXT
15020 DATA30,33,45,33,30,18,18,33
15060 FORA1=46384T046391
15070 READB1:POKEA1,B1:NEXT
15080 DATA12,18,33,45,45,33,18,12
15090 FORA1=46392T046399
15100 READB1:POKEA1,B1:NEXT
15110 DATA0,18,18,18,18,0,0,0
15120 FORA1=46400T046407
15130 READB1:POKEA1,B1:NEXT
15140 DATA0,0,0,0,0,18,18,18
15150 FORA1=46408T046415
15160 READB1:POKEA1,B1:NEXT
15170 DATA18,30,30,12,63,63,33,33
15180 FORA1=46416T046423
15190 READB1:POKEA1,B1:NEXT
15200 DATA33,63,12,18,33,18,12,12
15210 FORA1=46424T046431
15220 READB1:POKEA1,B1:NXT
15230 DATA63,63,63,63,63,63,63,63
15240 FORA1=46432T046439
15250 READB1:POKEA1,B1:NEXT
15260 DATAB,10,11,27,31,63,63,63
19997 REM-----
19998 REM      RESET VARIABLES
19999 REM-----
20000 SH=1:X1=14:FORT=5T033:CD(T)=0:NEXT
20010 SC=0:P=SK*.07+.2:BA=4:LI=1:FM=0:SM=0:A1=0:A2=0:A3=0:A4=0:W=0:
B0=0
20020 SH#STR$(SH):SC#STR$(SC)
20030 CLS:RETURN
```



Hangman

**Runs on
TRS-80**

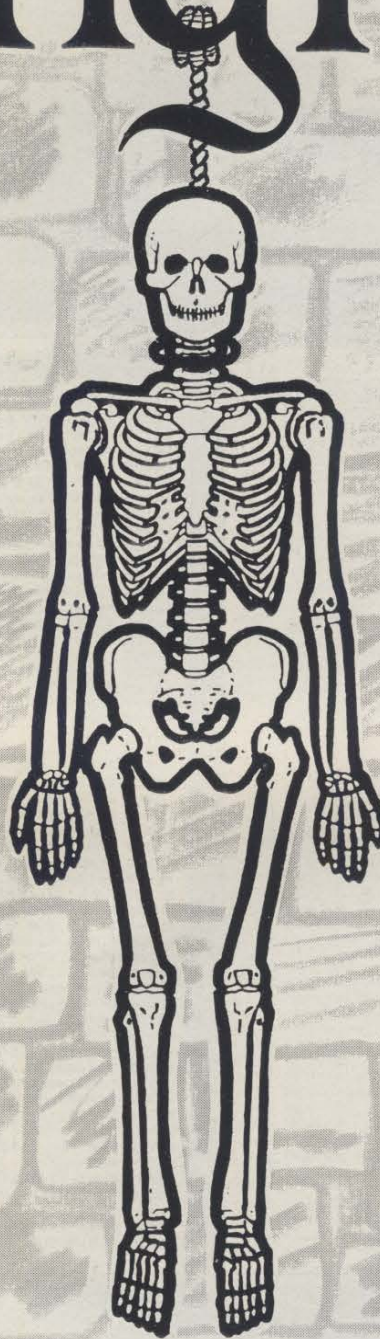

Hangman

This program is intended for use on the TRS-80, Video Genie range of computers. It will not need any explanation as there cannot be anyone who has not played Hangman using pencil and paper. Instructions however are included in the program.

To change the words in the program, the mystery word should be first, and in an odd numbered position in the data list, followed by the clue. The word pairs are grouped thus: Junior 30 pairs, Easy, 30 pairs, Medium, 50 pairs and Hard, 90 pairs. Words should be put in the appropriate position.

Conversion Clues

The processing statements of this program are in standard Microsoft Basic and should not cause any problems, except on Sinclair machines where the string handling is different.

As usual the problems of converting the program are caused by the graphics.

The Tandy screen is 16 rows of 64 characters, which are defined by the "PRINT @" positions numbered from 0 to 1023, or by POKE statements which are PRINT @ number plus 15360. The graphics characters are the standard Teletext set, which can be found most months in "Computing Today", (128 should be added to the published code, to make it Tandy compatible).

The gallows are drawn at the upper left hand side of the screen with the game status to the right. Input and other messages are printed near the bottom.

To convert the drawing of the gallows, instructions that draw a gallows in 10 sections, suitable to your computer should be put in lines 1000 to 1090 in reverse order (i.e. the first section to be drawn is line 1090), followed by: GOTO 1100 at the end of each line.

Instructions which may be unfamiliar are:
CLS — Clears screen.
INKEY\$ — Inputs a character from the keyboard. GET is the alternative on some

micros or the program will have to be changed to use an INPUT statement.
STRING\$(L,"—") — Produces L number of dashes.
CHR\$(255) — Produces 64 blank spaces, and is used in this program to clear lines for further printout.

RUNdown

Line	Action
10	Dimensions A\$ (array), randomises random number generator, clears screen. Instruction routine.
20-40	is the data list.
100-150	Sets up the VDU screen and obtains level of play
500-520	False input trap.
565	

570	Makes sure that A is an odd number, (the mystery word is odd, the clue even).
580-600	Reads word & clue into A\$,B\$ & resets the data counter.
610	Initialises the variables.
620-660	Prints heading & game info. to the right of screen.
670-690	Puts the letters of A\$ into array.
700-710	Inputs a letter.
720	Clears 2 lines for further output.
730-750	Checks to see if letter is in array, if yes goes to 810.
760	Wrong letter message.
770	Draws a section of gallows & decrement M.
780	Updates mistake score.
790	Checks to see if gallows is complete, if so prints game lost. Goes to new game?
800	Returns for next letter.
810	Correct letter message.
820	Puts letter into word on screen & deletes it from array.
830	Decrements no. of letters still to find.
840	Prints no. of letters to find and if not 0 returns for next letter.
850	Player wins printout.
860-880	New game? routine.
1000-1090	Each line contains graphics instruction for one section of the gallows.
1100	Decrements no. of mistakes left.
1120-1190	Instructions subroutine.

Variables Used

A\$	=	Mystery word.
L\$	=	Letter input.
A\$ (array)	=	Individual letters of mystery word.
B	=	PRINT @, position.
L	=	no. of letters in word.
R	=	No. of letters to find.
B\$	=	Clue.
Q\$	=	General string input.
M	=	Mistakes left.
C,N&X	=	For next counters.

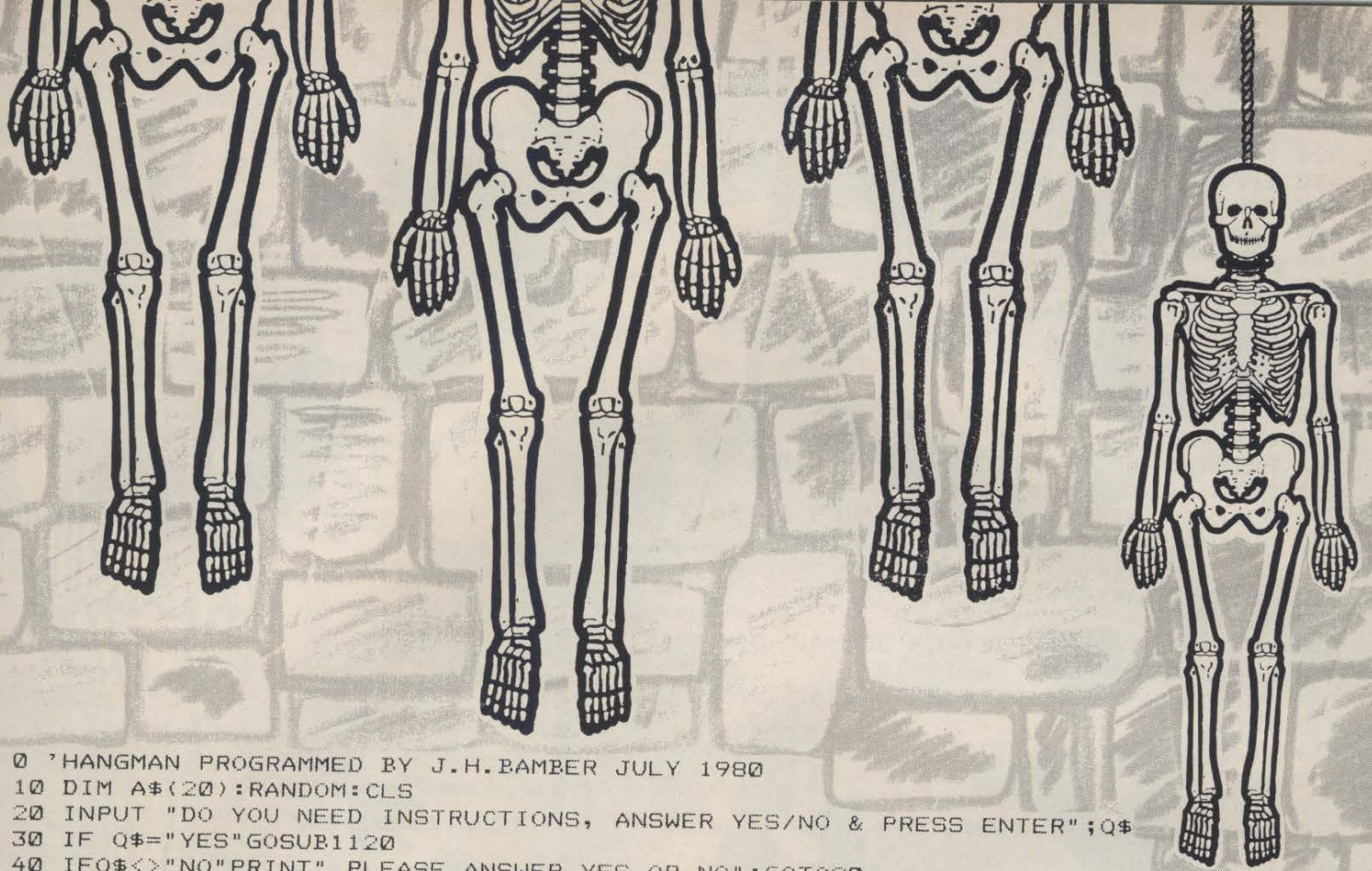

```

0 ?HANGMAN PROGRAMMED BY J.H.BAMBER JULY 1980
10 DIM A$(20):RANDOM:CLS
20 INPUT "DO YOU NEED INSTRUCTIONS, ANSWER YES/NO & PRESS ENTER";Q$
30 IF Q$="YES"GOSUB1120
40 IFQ$<>"NO"PRINT" PLEASE ANSWER YES OR NO":GOTO20
100 DATABALL,BOUNCY,APPLE,FRUIT,ORANGE,FRUIT,PUSSY,CAT,PUNCH,AND JUDY,HAT,CAP,RI
NG,ROUND,RED,COLOUR,BABY,CHILD,DOLL,TOY,BUN,CAKE,TEDDY,BEAR,DISH,PLATE,CROSS,ANG
RY,HAPPY,GLAD,FALL,TRIP,GIFT,PRESENT,SMALL,LITTLE,PEEP,LOOK,SHUT,CLOSE,TWO,PAIR
105 DATASLEEP,NAP,ROUND,CIRCLE,STONE,PEBBLE,FUNNY,JOKE,DRESS,FROCK,MAT,CARPET,DO
G,PET,LOT,MUCH,DAISY,FLOWER,LEAP,JUMP,LEAFY,TREE,BUCKET,PAIL,SIMPLE,EASY,WATER,W
ET,HEAL,CURE,FOG,MIST,SHAM,FAKE,DANGER,PERIL,CANDID,FRANK,KEEN,EAGER,BLUE,AZURE
110 DATAEDGE,RIM,BLAZE,FIRE,ICY,COLD,STRING,CORD,LAZY,IDLE,FINAL,LAST,TASK,JOB,F
RESH,NEW,THIN,SLIM,HIGH,LOFTY,GLAD,HAPPY,TEAR,RIP,SILLY,DAFT,BOY,LAD,GIRL,LASS,F
ALL,SLIP,LET,ALLOW,MINUTE,TINY,SHARP,EDGED,SECURE,SAFE,LEGAL,LAWFUL,ROUSE,WAKE
115 DATACORRECT,RIGHT,PILE,STACK,SNUG,COSY,TIMID,SHY,SEARCH,SEEK,RETAIN,KEEP,JOU
RNEY,TRAVEL,INITIAL,FIRST,HUE,SHADE,DANGER,RISK,EXPAND,GROW,GALE,STORM,FUSS,ADO,
METHOD,WAY,ALIEN,FOREIGN,MUTE,DUMB,GHOST,SPOOK,RESCUE,SAVE,FRAIL,WEAK,CRUSH,SQUA
SH
120 DATAELBOW,JOINT,CRAFTY,SLY,SMALL,TINY,POLITE,CIVIL,FAST,QUICK,WEALTH,RICHES,
SAILOR,MARINER,MYTH,FABLE,OCCUR,HAPPEN,HEATHEN,PAGAN,THIRSTY,DRY,VALUE,WORTH,SKI
LL,ABILITY,LAIR,DEN,ABHOR,LOATHE,BUSH,SHRUB,RESIDE,LIVE,NEAR,CLOSE,JESTER,CLOWN
125 DATACORSAIR,PIRATE,TRUDGE,PLOD,PUNY,FEEBLE,ADHERE,STICK,AMOUNT,SUM,ABHOR,DET
EST,ZEPHYR,BREEZE,YACHT,BOAT,EXCESS,SURPLUS,REQUEST,ASK,RANCID,SOUR,ECSTASY,BLIS
S,ABHOR,HATE,FACADE,FRONT,OBESSE,FAT,PRECISE,EXACT,ENIGMA,MYSTERY,ECHO,REPEAT
130 DATAROGUE,RASCAL,ARID,DRY,SCATTER,STREW,REMOTE,DISTANT,REPLICA,COPY,SQUIRM,W
RITHE,PUZZLE,MYSTIFY,OBTUSE,STUPID,OUTCOME,RESULT,ZENITH,PEAK,SUCCOUR,AID,TRANQU
IL,SERENE,NOVICE,TYRO,UNIQUE,SOLE,SKETCH,OUTLINE,CONCUR,AGREE,THREATEN,MENACE
135 DATAECONOMY,THRIFT,RESIGN,QUIT,RECLUSE,HERMIT,ROWAN,TREE,SEQUOIA,TREE,GUARDS
MAN,SOLDIER,HUSSAR,SOLDIER,INANE,STUPID,QUAINT,UNUSUAL,ABSCOND,RUN AWAY,ASPECT,V
IEW,OBSTRUCT,HINDER,PICTURESQUE,SCENIC,DELICATE,FRAGILE,YARN,STORY,WRESTLE,FIGHT
140 DATAGYRATE,WHEEL,VIBRATE,SHIVER,VERBAL,SPOKEN,UNDO,LOOSEN,SEETHE,BOIL,TRIBE,
FAMILY,BOLIVIA,COUNTRY,SYCAMORE,TREE,LABURNUM,TREE,ABYSS,CHASM,AQUIRE,OBTAIN,REA
SON,CAUSE,MARIGOLD,FLOWER,PAMPER,SPOIL,DEPEND,RELY,ANTICIPATE,EXPECT,IMITATION,C
OPY
145 DATAFATUOUS,INANE,IFINITE,VAST,GUARANTEE,INSURE,KNAVE,VILLAIN,LABYRINTH,MAZE
,NEUTRAL,IMPARTIAL,NIMBLE,AGILE,SAUNTER,STROLL,DERIDE,SCOFF,ANIMOSITY,MALICE,HAG
GARD,GAUNT,DREARY,BORING,REVERIE,DREAM,EPOCH,ERA,FALLACIOUS,UNTRUE,COMMOTION,FUS
S
150 DATAIMPUDENT,CHEEKY,DEAFENING,LOUD,QUAGMIRE,BOG,COMBINE,MIX,OBNOXIOUS,ODIOUS
,PETUNIA,FLOWER,GEUM,FLOWER,ANENOME,FLOWER,DELPHINIUM,FLOWER,NASTURTIUM,FLOWER,U
LTIMATE,LAST,PROVERB,ADAGE,ANTIRRHINUMUM,FLOWER
500 CLS:PRINT@25,"H A N G M A N";
510 PRINT@704,"PRESS THE FIRST LETTER OF THE LEVEL YOU WISH TO PLAY AT,
(J)UNIOR, (E)ASY, (M)EDIUM OR (H)ARD"

```

```

520 A$=INKEY$: IFA$=""GOTO520
530 IFA$="J"A=RND(60):GOTO570
540 IFA$="E"A=RND(60)+60:GOTO570
550 IFA$="M"A=RND(100)+120:GOTO570
560 IFA$="H"A=RND(180)+220:GOTO570
565 A$="":PRINT"YOU MUST PRESS J,E,M, OR H":GOTO520
570 IF INT(A/2)*2=ATHENA=A-1
580 FOR N = 1 TO A STEP 2
590 READ A$,B$
600 NEXT N:RESTORE
610 B=288:L=LEN(A$):R=L
620 CLS:PRINT@25,"H A N G M A N";
630 PRINT@224,"YOUR CLUE IS :- ";B$;
640 PRINT@B,STRING$(L,"-");
650 M=10:PRINT@416,M;" MISTAKES TO GO";
660 PRINT@352,L;" LETTERS TO FIND";
670 FOR C=1TO L
680 A$(C)=MID$(A$,C,1)
690 NEXT
700 PRINT@704,"WHAT LETTER DO YOU CHOSE?";
710 L$=INKEY$: IFL$=""GOTO710
720 PRINT@704,CHR$(255):PRINT@768,CHR$(255)
730 FOR C = 1 TO L
740 IFA$(C)=L$ GOTO 810
750 NEXT
760 PRINT@786,"WRONG THIS TIME"
770 ON M GOSUB1090,1080,1070,1060,1050,1040,1030,1020,1010,1000
780 PRINT@416,M;
790 IF M = 0 PRINT@832,"YOU LOSE, THE WORD IS :- ";A$:GOTO 860
800 GOTO700
810 PRINT@768,"GOOD IT'S RIGHT!!!";
820 PRINT@B+C-1,A$(C);:A$(C)="0"
830 R=R-1
840 PRINT@352,R;:IF R > 0 GOTO 700
850 IF R = 0 PRINT@832,"YOU WIN !!! THE WORD IS :- ";A$
860 PRINT@896,"DO YOU WANT TO PLAY AGAIN, ANSWER YES OR NO & PRESS ENTER";:INPUT
Q$
870 IFQ$="YES"GOTO 500
880 PRINT@896,CHR$(255):IFQ$<>"NO"PRINT@960,"PLEASE ANSWER YES OR NO, & PRESS EN
TER ";:GOTO 860
890 END
1000 FORX=15942 TO 15964 : POKEX,176:NEXT:GOTO1100
1010 FORX=15452 TO 15964 STEP64:POKEX,149:NEXT:GOTO1100
1020 FORX=15440 TO 15451:POKEX,131:NEXT:GOTO1100
1030 POKE15448,167:POKE15513,165:POKE15578,165:POKE15579,176:POKE15834,150:POKE1
5835,131:POKE15897,150:POKE15960,182:GOTO1100
1040 POKE15440,191:POKE15504,179:POKE15505,153:POKE15503,166:GOTO1100
1050 POKE15568,191:POKE15632,191:POKE15696,191:GOTO1100
1060 POKE15569,140:POKE15570,144:POKE15634,130:POKE15635,164:POKE15700,137:GOTO
1100
1070 POKE15567,140:POKE15566,160:POKE15630,129:POKE15629,152:POKE15692,134:GOTO1
100
1080 POKE15759,134:POKE15758,160:POKE15822,129:POKE15821,152:GOTO1100
1090 POKE15761,137:POKE15762,144:POKE15826,130:POKE15827,164
1100 M=M-1:RETURN
1110 END
1120 CLS:PRINT"THIS IS A GAME WHERE YOU HAVE TO FIND A WORD I HAVE CHOSEN,"
1130 PRINT"I WILL GIVE YOU A CLUE AND TELL YOU HOW MANY LETTERS.
1140 PRINT" YOU HAVE TO TYPE IN THE LETTERS ONE AT A TIME, IF TWO "
1150 PRINT"LETTERS ARE THE SAME ONLY ONE SPACE WILL BE FILLED FOR EACH
ENTRY."
1160 PRINT" IF YOU GET A LETTER WRONG A SECTION OF THE GALLOW'S WILL BE DRAWN."
1170 PRINT" THERE ARE TEN SECTIONS TO BE DRAWN BEFORE YOU ARE HANGED,
AND IF YOU GET THE WORD RIGHT BEFORE THE GALLOW'S ARE DRAWN YOU
BEAT THE HANGMAN AND WIN.
1180 INPUT" SO PRESS ENTER TO START PLAYING,
AND THE BEST OF LUCK !!!!!";Q$
1190 Q$="NO":RETURN

```

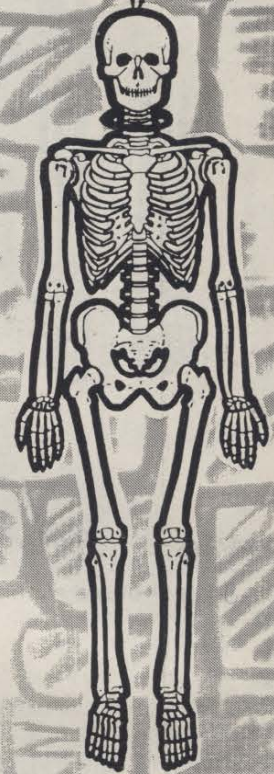



a celebratory "Whoop", otherwise the computer blows a raspberry!

RUNdown

Line	Action
12-60	Introduction
100-110	Set up main variables.
120-288	Random numbers and Picture cards.
300-330	Deal cards.
340-346	Random suites.
350	If correct then goto "win" routine.
360-502	Check if correct and print next card.
600-811	Print cards routines.
950-952	"Wrong" routine.
1005-1015	"Win" routine.
1050-1051	"Pair" routine.
2000-2040	"Win" sound routine.
3000-3030	Bleep routine.
4000-4040	"Wrong" sound routine.

Play your cards right

This program is a version of the popular television series of the same name, but without the habits and persona of Bruce Forsythe.

The program runs in just over 5K RAM on any expanded VIC-20. When run, a copyright notice scrolls up the screen followed by an instruction page. Pressing "D" deals four cards, all face down but the first. The brief instructions in the program are self explanatory. On upturning all the cards successfully, the player is treated to

Variables used

Line	Action
A	Cards face down.
C6-C8	Cursor lefts.
J,NC	Counter flags.
V	Volume location (36878)
S1-S3	Voices.
R1-R4	Card values.
RS	Random suits.
S	Suit.
C	Suit colours.
O,K	Which random numbers.
SS	Screen scroll location (36865)
A	Wrong answer flag.

Conversion clues

Conversion to other micros should be a fairly simple process. The suit symbols are part of the VIC standard character set and can either be omitted or user defined graphics used. "Get" can be replaced by "Inkeys". the reverse characters are mostly cursor controls and can be replaced with "Print At".

Cursor controls

Reverse heart	= CLR/CURSOR HOME
Reverse "S"	= CURSOR HOME
Reverse square bracket	= CURSOR RIGHT
Reverse "Q"	= CURSOR DOWN

NEW
UNEXPANDED
VIC 20
GAMES DESIGNER

Make Great Games...
Create your own amazing games with Galactics unique
GAMES DESIGNER cassette for the unexpanded
VIC 20, only £9.50

EXPLORE EXCITING NEW HORIZONS

Galactic Software

UNEXPANDED VIC 20
GAMES - KEYBOARD
OR JOYSTICK.
COMMODORE 64
GAMES - JOYSTICK
CONTROL
DRAGON 32 GAMES -
KEYBOARD CONTROL

**"MAKE GREAT GAMES AND WIN £100 AND
FAME!! Send us your best game made with the
Galactic GAMES DESIGNER, before 14th March,
and have a chance to win £100 plus having your
game shown to International Software Dealers
and Distributors.**

ROBOT MOUSE
£5.50 - VIC 20



SPACE SHUTTLE
£5.50 - VIC 20

**GALACTIC
SOFTWARE**

Unit 7,
Larchfield Estate,
Dowlish Ford,
Ilminster, Somerset.
TA19 0PF
Tel: (04605) 5161



FROGGY £5.50 -
VIC 20, Commodore 64 or Dragon 32.

**ALL IN
MACHINE
CODE**

- * Variable degree of difficulty
- * Make your own Monsters, Moonscapes, Space Ships, Aliens, Kangaroos or Asteroids
- * Create your very own Games



GAMES DESIGNER
for the unexpanded
VIC 20 £9.50 inc. P&P.

- MAKE GREAT GAMES**
- * No Programming experience needed
 - * Full colour Hi-Res Graphics
 - * Make your own sound effects
 - * Joystick or Keyboard control

3D MAZE
£5.50 - VIC 20



**DEALERSHIP
ENQUIRIES
CONTACT
04605 5161**



BUG DIVER
£5.50, VIC 20,
Commodore 64 or
Dragon 32



NEUTRON ZAPPER
£5.50 - VIC 20

PLEASE SEND ME THE FOLLOWING GAME(S)

(PLEASE TICK APPROPRIATE BOX(S))

- BUG DIVER FOR VIC 20 £5.50
- 3D MAZE FOR VIC 20 £5.50
- FROGGY FOR VIC 20 £5.50
- NEUTRON ZAPPER FOR VIC 20 £5.50
- ROBOT MOUSE FOR VIC 20 £5.50

MONEY BACK GUARANTEE

- SPACE SHUTTLE FOR VIC 20 £5.50
- GAMES DESIGNER FOR VIC 20 £9.50
- BUG DIVER FOR COMMODORE 64 £5.50
- FROGGY FOR COMMODORE 64 £5.50
- BUG DIVER FOR DRAGON 32 £5.50
- FROGGY FOR DRAGON 32 £5.50

I ENCLOSE A CHEQUE/P.O. FOR THE
TOTAL SUM OF £ _____

ACCESS NO

NAME _____

ADDRESS _____

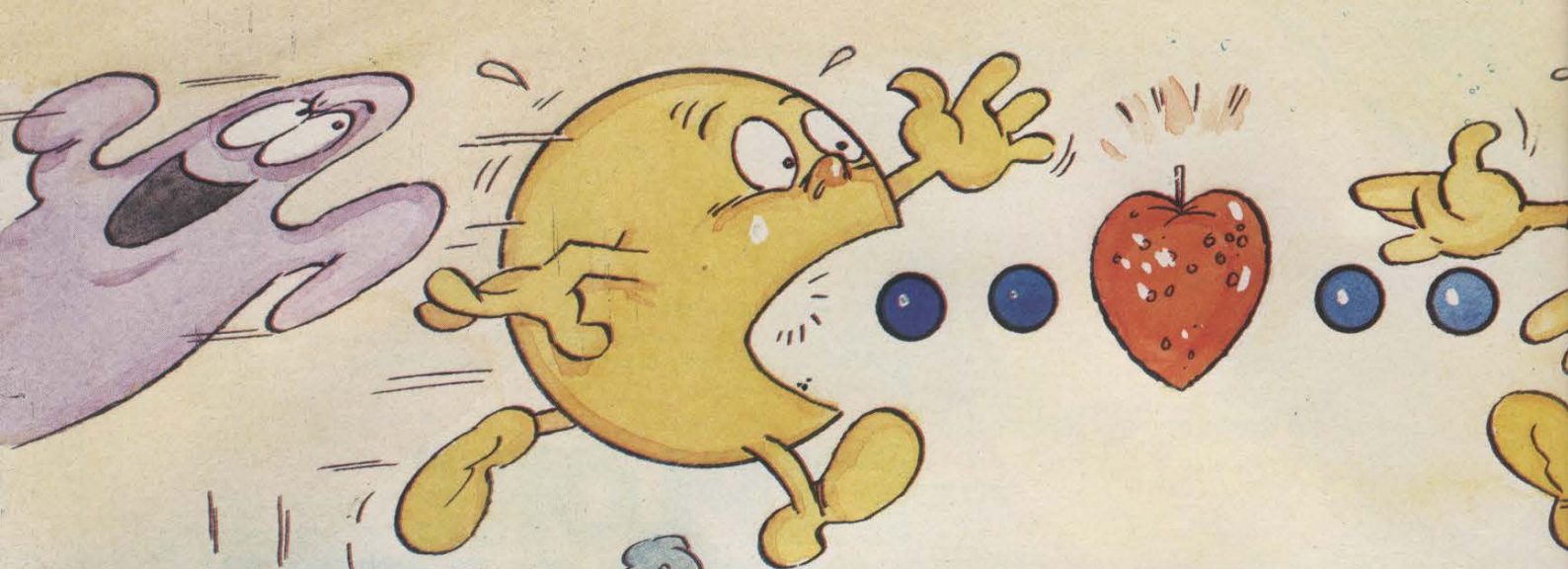

MUNCH!
MUNCH!
MUNCH!

Spuck

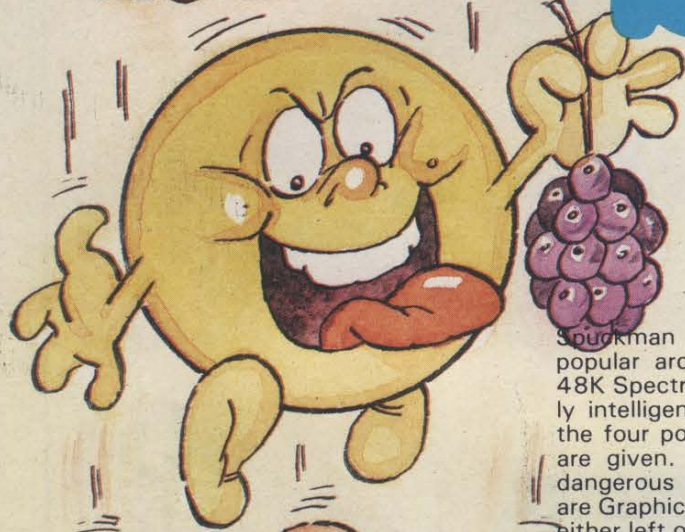

Spuckman is a version of the ever popular arcade game for the 16K or 48K Spectrum. There are two extremely intelligent ghosts, so you will need the four power pills and five lives you are given. The ghosts are red when dangerous and green when safe, and are Graphic 'A's. The Muncher can face either left or right, and so is defined on to the keys 'B' and 'C'. The main problem encountered when writing the program, was preventing the ghosts from getting trapped in dead ends and corners of the maze, and this problem was only overcome by redesigning the layout with a minimum of these restricting positions present. The game is far from easy, but the ghosts can be slightly disabled by adding a random element to the movement logic in lines 105 to 155.

Keys T, V, F and G, are used for movement, but these can be altered as desired in line 90.



Warning! Save and verify the program before running!
 Here is a general breakdown of the listing.

RUNdown

Lines	Action
1	Protects listing from erasure.
10 & 20	Increment Score.
30	GOSUB sets up variables and Maze.
40 & 60	More characters.
50	Calculate which way the Muncher is facing.
40 & 60	More characters.
50	Calculates which way the Muncher is facing.
70-90	Calculate new position of Muncher.
100-155	Boolean Algebra for movement of The Ghosts.
160-220	Check for eating of power-pill, capture, exit/entrance etc.
230 & 240	Loss of a life/end of game.
250-310	Draw Maze and set up variables.
Variables	Use
P	Direction of Muncher.
P\$	Appearance of Muncher (depends on P).

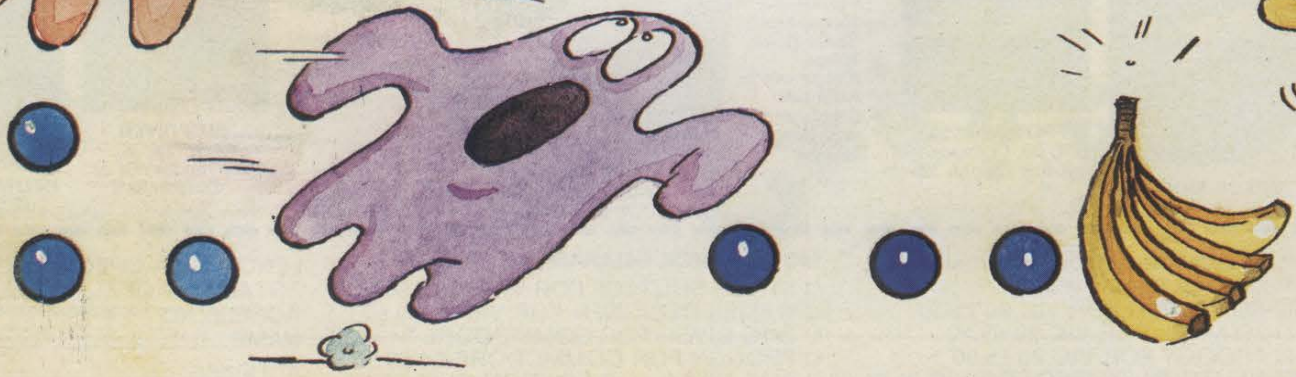



Runs on Spectrum

man

```

1 POKE 23568,2: GO TO 30: REM
SPUCKMAN © A. Weekes 1982
10 LET sc=sc+5: BEEP 0.01,50:
BEEP 0.01,-20: IF sc=1575 THEN L
ET s=s+sc: BEEP 1,23: LET sc=0:
GO SUB 300
20 RETURN
30 GO SUB 250
35 IF m<>m1 OR n<>n1 THEN PRIN
T AT m1,n1;S$(m1,n1); INK PP+3;A
T m,n;" "
40 IF x<>x1 OR y<>y1 THEN PRIN
T AT x1,y1;S$(x1,y1); INK PP+3;A
T x,y;" "
50 IF b<>b1 THEN LET p=2-SGN (
b-b1)
60 IF a<>a1 OR b<>b1 THEN PRIN
T AT a1,b1;" "; INK 6;AT a,b;P+1
P)
70 LET a1=a: LET b1=b: LET x1=
x: LET y1=y: LET m1=m: LET n1=n
80 IF INKEY$(0)="" THEN LET a$=I
NKEY$
90 LET a=a+(a$="v")-(a$="t"):
LET b=b+(a$="g")-(a$="f"): IF AT
TR (a,b)>64 THEN LET a=a1: LET b
=b1
100 IF PP=1 THEN GO TO 140
105 LET m=m+(m<a)-(m>a): IF ATT
R (m,n)>64 THEN LET m=m1
110 LET x=x+(x<a)-(x>a): IF ATT
R (x,y)>64 THEN LET x=x1
115 LET n=n+(n<b)-(n>b): IF ATT
R (m,n)>64 THEN LET n=n1
120 LET y=y+(y<b)-(y>b): IF ATT

```

- A\$ Used for reading keyboard.
- S&SC Scoring variables.
- X,Y&X1,Y1 Co-ordinates of Ghost 1.
- M,N Co-ordinates of Ghost 2
- &M1,N1 Co-ordinates of Muncher.
- A,B&A1,B1 Stores all wafers in an array.
- S\$(22,31) Power Pill state (1=On, 0=Off)
- PP Utility variables.
- F&C

Conversion Clues

Most of the Functions used can be easily converted to an equivalent function.

Function	Equivalent
Inkeys\$	Get or Get\$.
Attr	Point or Locate.
Print at	Position of Print Tab or Print @.
BEEP	Sound (or can be omitted).
Border/ Paper/Ink Flash Bright	Can be omitted or changed. Can be omitted. Some way must be found of making the maze a different colour or intensity from the rest of the display so that it can be detected by ATTR (or equivalent) in lines 90,100,120 & 300.

U.D.G's

Can be omitted or converted, as methods of defining vary considerably. Otherwise I suggest (inverse quotes for Ghosts, and & (greater than/smaller than signs) for the Muncher. The Pokes in line 1 are just to protect the program against erasure, and can be omitted.

POKE

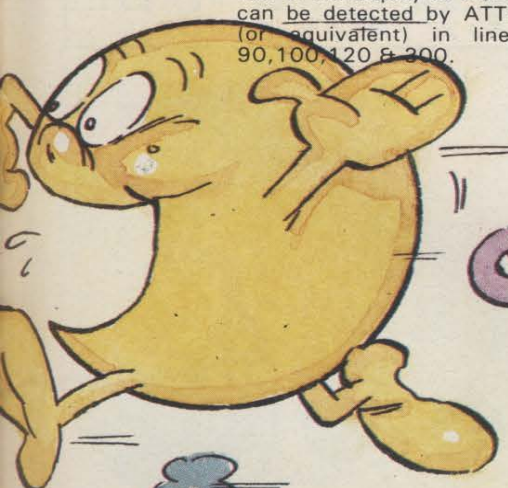

CHOMP!
CHOMP!
CHOMP!



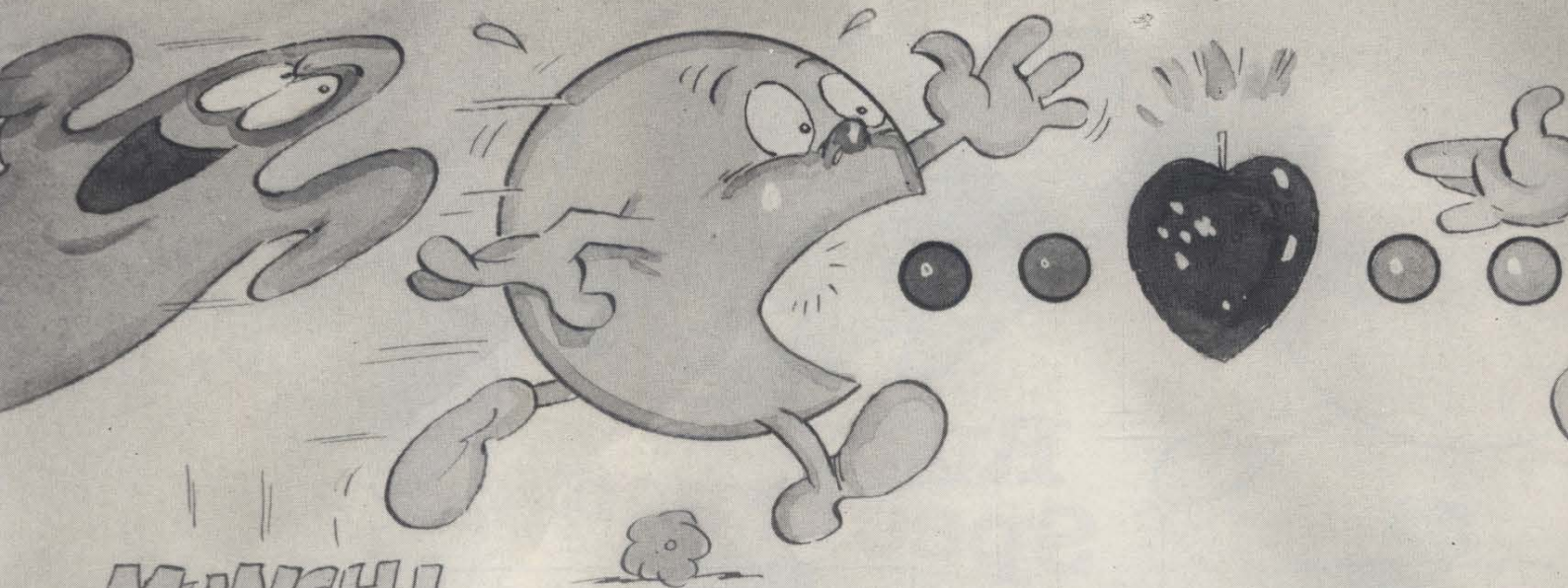

**MUNCH!
MUNCH!
MUNCH!**

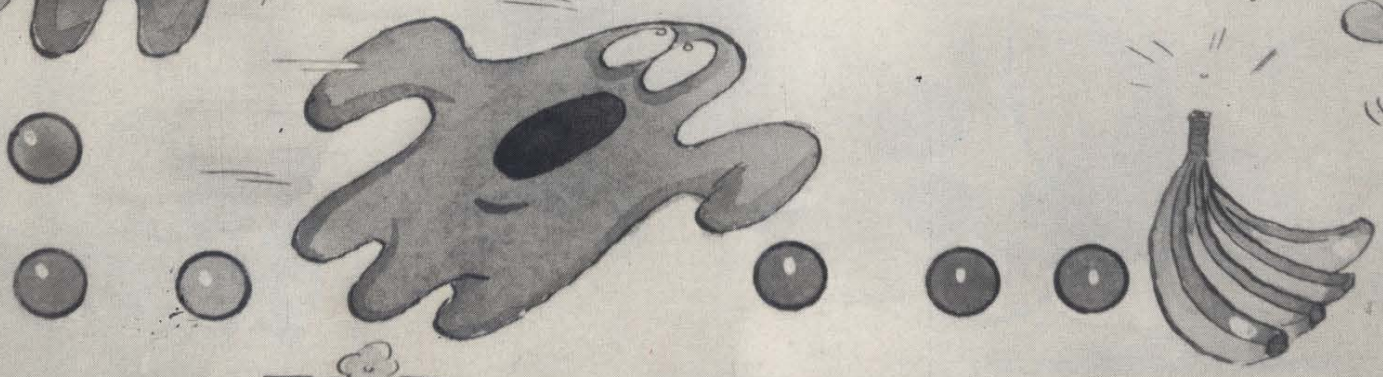

```

R (X,Y)>64 THEN LET Y=Y1
130 GO TO 160
140 LET X=X+(X>a)-(X<a): IF ATT
R (X,Y)>64 THEN LET X=X1
145 LET M=M+(M>b)-(M<b): IF ATT
R (M,N)>64 THEN LET M=M1
150 LET Y=Y+(Y>b)-(Y<b): IF ATT
R (X,Y)>64 THEN LET Y=Y1
155 LET N=N+(N>b)-(N<b): IF ATT
R (M,N)>64 THEN LET N=N1
160 IF X=a AND Y=b OR M=b AND N
=5 THEN IF PP=0 THEN GO TO 225
170 IF S$(a,b)="" THEN GO SUB
10
180 IF S$(a,b)="" THEN LET PP=
1: LET TI=0: BORDER 4: BEEP 0.5,
0
190 LET S$(a,b)="" : IF a=1 AND
b=15 OR a=19 AND b=15 THEN LET
a=20-a
200 IF PP=1 THEN LET TI=TI+1: I
F TI=40 THEN BORDER 2: LET PP=0:
BEEP 0.5,-30
210 IF PP=1 THEN IF a=X AND b=Y
OR a=M AND b=N THEN LET S=S+200
BEEP 0.2,30: LET X=4: LET Y=23
LET M=4: LET N=2: BORDER 2: LE
T PP=0
215 IF M=X AND N=Y THEN LET X=X
1: LET Y=Y1
220 PRINT AT 0,0: BRIGHT 1;S+S
": BRIGHT 0: GO TO 35
225 PRINT AT 31,b1: FLASH 1: IN
K 6: PAPER 2: "A": LET LI=LI-1: P
RINT AT 0,31-LI: " ": BEEP 1,45:
PRINT AT a1,b1: " ": LET X=4: LET
Y=23: LET M=4: LET N=2: LET a=1
0: LET b=15: IF LI<>0 THEN GO TO
35
230 PRINT AT 10,6: "ANOTHER GO ?
": FOR X=-20 TO 20: BEEP 0.01,X:
BEEP 0.01,-X: NEXT X: PAUSE 0:
PAUSE 0: IF INKEY$(<>)="Y" THEN STO
P
240 RUN
250 FOR X=USR "a" TO USR "c"+7:
READ Y: POKE X,Y: NEXT X
  
```

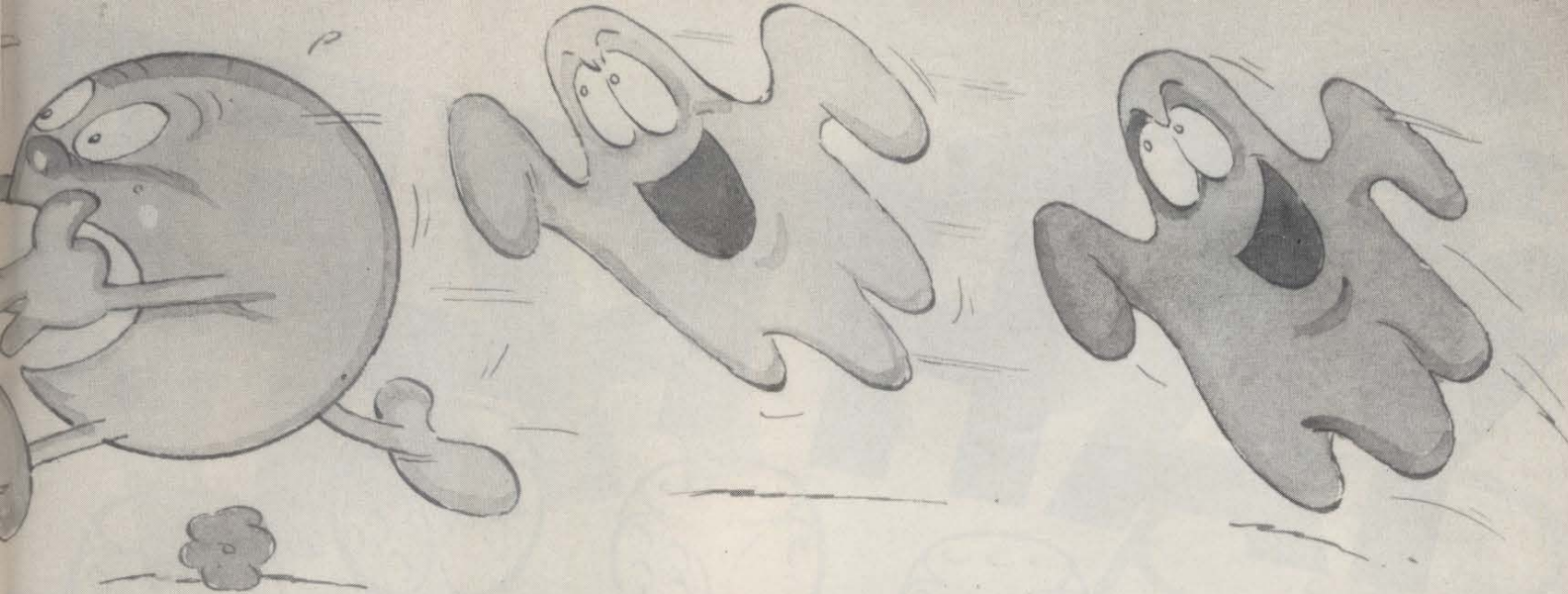
```

260 DATA 60,255,219,255,195,255
,153,153,60,126,239,127,31,127,127
54,60,60,126,247,254,246,254,127
,60
270 PRINT AT 18,15;"*": LET LL=
5: LET P$="* *": LET S$="": LET
S=0: LET SC=0: LET M=4: LET N=2:
LET M1=M: LET D1=D: LET X=4: LE
T U=26: LET X1=X: LET Y1=Y: LET
S=18: LET B=15: LET Z1=9: LET B1
=5: LET P=1: DIM S$(22,31): LET
PP=0: INK 6: PAPER 0: CLS: BORD
ER 2: BRIGHT 1
280 READ F,G: IF F=99 THEN FOR
F=0 TO 21: PRINT AT F,31;"*": NE
XT F: FOR F=0 TO 31: PRINT AT 21
,F;"*": NEXT F: GO TO 300
290 PRINT AT F,G;"*": AT 20-F,G:
"*": AT 20-F,30-G:"*": AT F,30-G:"
*": GO TO 280
300 BRIGHT 0: FOR F=1 TO 10: FO
R G=1 TO 15: IF ATTR(F,G) < 64 TH
EN PRINT AT F,G:"*": AT 20-F,G:"
*": AT 20-F,30-G:"*": AT F,30-G:"
*": LET S$(F,G)="*": LET S$(20-F,G)
)="*": LET S$(20-F,30-G)="*": LET
T S$(F,30-G)="*":
310 DATA 0,11,0,10,0,15,4,15,0,
0,0,1,0,2,0,0,4,0,5,0,0,7,0,
0,0,9,0,10,0,11,0,12,0,13,0,14,0,
19,1,0,1,1,0,1,0,1,4,1,5,1,6,0,
1,7,1,0,1,0,1,10,1,11,1,10,1,10,
1,14,2,0,0,1,0,0,0,0,0,0,0,0,0,0,
0,7,4,0,0,1,4,7,4,0,4,11,4,10,0,0,
0,0,1,0,0,0,0,0,0,0,0,0,0,1,0,0,0,
0,0,0,0,11,0,10,0,14,0,0,10,0,0,7,
0,11,0,0,7,0,0,0,0,0,0,0,0,0,11,
0,10,0,14,0,0,0,0,0,0,0,0,0,7,0,
0,0,11,0,10,0,14,10,0,10,0,10,7,
10,11,09,09
320 NEXT G: NEXT F: PRINT AT 0,
27: BRIGHT 1;"*****": BRIGHT 0:
LET S$(0,1)="*": LET S$(13,20)="*
*": LET S$(17,11)="*": LET S$(17,21
9)="*": PRINT AT 0,1;"*": AT 17,1
1;"*": AT 0,29;"*": AT 17,29;"*": R
ETURN

```

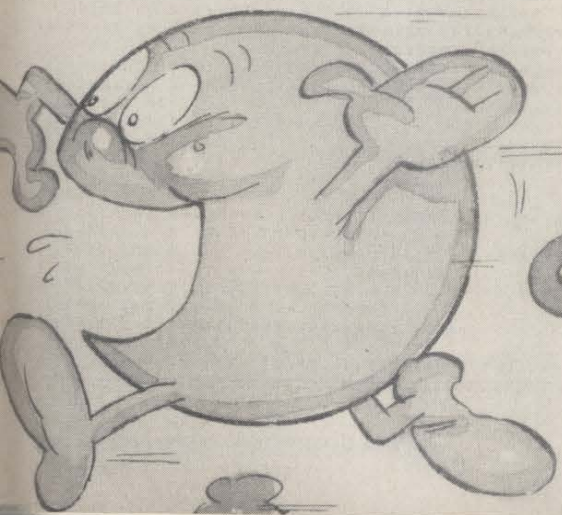

CHOMP!
CHOMP!
CHOMP!



Runs on
Atom

YAHTZEE

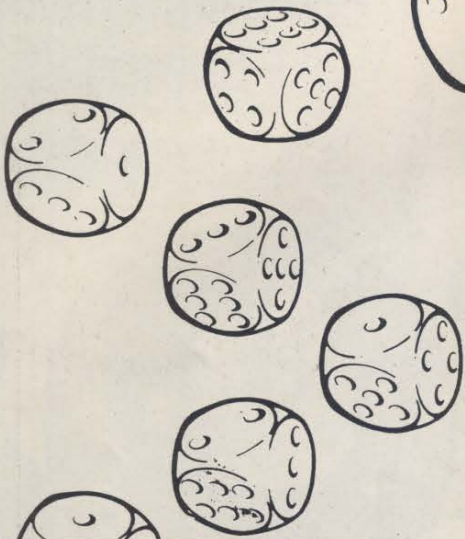

Yahtzee (needs 5K text 1K graphics)

Yahtzee is a dice game for up to four players. All 5 dice can be rolled up to 3 times, each dice can be held whilst the rest are rolled. The object is to roll the dice and fill the score grid categories. The grid looks as follows:

Category	Example	Score
ONES	12141 (score=3)	Additive total of all Ones present.
TOWS	26451 (score=2)	Additive total of all Twos present.
THREES	36313 (score=9)	Additive total of all Threes present.
FOURS	46125 (score=4)	Additive total of all Fours present.
FIVES	51535 (score=15)	Additive total of all Fives present.
SIXES	61665 (score=18)	Additive total of all Sixes present.
3 KIND	333 other 2 dice can be anything (score=9 + other 2 dice).	Additive face total of all dice provided 3 dice are the same.
4 KIND	2222 other dice can be anything (score=8 + other dice)	Additive face total of all dice provided 4 dice are the same.
4 STRT	1234 or 2345 or 3456	30
5 STRT	12345 or 23456	40
FULL Ho	66611 or 44222	25
YAHTZEE	All dice with same face value	50
CHANCE		Additive face value of all dice.

If the categories 1-6 have a total of 63 or more a bonus of 35 is given, (i.e. at least 3 of each kind must be gained).

Once a category is used by a player it cannot be re-used by that player.

```

3D1MAA(14),BB(14),CC(14),DD(14),EE(14),FF(6),P-1,V=#2800
4P.$21;L;FF6 JSR#FFE3;STA#90;RTS;1;Q=#80;G.1
5mCLEAR0;P.$30"HOW MANY PLAYERS (MAX 4)?" ;LI.FF6;@=4
9R=?#90-48;P.R' ;?#E1=0;U=#2880;IFR)4G.m
20P=0;X=-7;#V="";P."NAMES (MAX 6 CHARACTERS)";F.S=1TOR;X=X+7
22IN.$U;#V+LEN(V)=#U;F.F=LEN(V)TO(X+6);#V+LEN(V)=" ";N.
25N.;CLEAR0;S=(13*R)+1;F.A=1TO13;AA(A)=-1;BB(A)=-1
27CC(A)=-1;DD(A)=-1;EE(A)=0;N.;AA(0)=0;BB(0)=0;CC(0)=0
30DD(0)=0;EE(0)=0;AA(14)=0;BB(14)=0;P.$30;CC(14)=0;DD(14)=0
40P."1-ONES""2-TWOS""3-THREES""4-FOURS""5-FIVES""6-SIXE"
45P."S""7-3 KIND""8-4 KIND""9-4 STRT""10-5 STRT""11-FUL"
50P."L HO""12-YAHTZEE""13-CHANCE"" TOTAL"#30;?#E0=28
55P."dice";MOVE22,6;DRAW22,48;MOVE30,6;DRAW30,48;MOVE38,6
60DRAW38,48;MOVE46,6;DRAW46,48;MOVE54,6;DRAW54,48;@=0
70dP=P+1;IFP=R+1 P=1
75S=S-1;IFS=0G.1
76N=P*4;F.L=(#8008+N)TO#81AB+N S.32;F.F=L TO L+2
80?F=128+?F;N.;N.;Y=0;F.F=0TO14;IFP=4;EE(F)=DD(F)
821FF=3;EE(F)=CC(F)
851FF=2;EE(F)=BB(F)
871FF=1;EE(F)=AA(F)
90N.;A=A.R.%6+1;B=A.R.%6+1;C=A.R.%6+1;D=A.R.%6+1;E=A.R.%6+1
92GOS.a;DO Y=Y+1;GOS.e
95F=(P-1)*7;#U=#V+F;#U+7="";GOS.q
98P."DICE TO ROLL F=NON"
99#G=" ";IN.$Q;P.$11;LI.#FE22;IF#Q="F";Y=5;G.g
100F.G=OTOS;F.F=0TO4;IFF?Q=65;A=A.R.%6+1
1021FF?Q=66;B=A.R.%6+1
1051FF?Q=67;C=A.R.%6+1
1071FF?Q=68;D=A.R.%6+1
1101FF?Q=69;E=A.R.%6+1
112N.;GOS.a;N.
115G.U.Y)1
120HGOS.e;#Q="";GOS.q;IN."RESULT CATEGORY 1-13"#Q;P.$11;X=90
121LI.#FE22;IF?Q=13;X=?Q-48;C.124
122IF2?Q=13;X=(1?Q-48)+10*(?Q-48)
1241FX)13 ORX(1 G.h
1251FX(7 G.600
127G.(600+(X*20))
130bP.$30;EE(14)=0;F.F=1TO13;IFEE(F)(0;G.137
135EE(14)=EE(14)+EE(F)
137N.;IFEE(0)62;EE(14)=EE(14)+35;GOS.e;P."BONUS GIVEN";G.f
140F.F=1TO14
1411FF=1;AA(F)=EE(F);?#E0=12;IFAA(F))-1;P.AA(F);AA(0)=EE(0)
1421FF=2;BB(F)=EE(F);?#E0=16;IFBB(F))-1;P.BB(F);BB(0)=EE(0)
1451FF=3;CC(F)=EE(F);?#E0=20;IFCC(F))-1;P.CC(F);CC(0)=EE(0)
1471FF=4;DD(F)=EE(F);?#E0=24;IFDD(F))-1;P.DD(F);DD(0)=EE(0)
150P.;N.;R.
172fP.$7$7$7$7$30;F.F=0TO30;WAIT;N.;G.140
175wGOS.e;P."SELECTION USED ";F.F=0TO25;WAIT;N.;G.h
180eP.$30";R.
190;FF(1)=AA(14);FF(2)=BB(14);FF(3)=CC(14);FF(4)=DD(14)
193F.B=1TO3;F.C=B+1TO4;IFFF(B)(FF(C) G.196
195D=FF(B);FF(B)=FF(C);FF(C)=D
196N.;N.;F.F=0TO200;WAIT;N.;P.$12;@=5;F.F=4TO(5-R) S.-1;O=0
200IFFF(F)=AA(14);#U=#V;GOS.o
205IFFF(F)=BB(14);#U=#V+7;GOS.o
206IFFF(F)=CC(14);#U=#V+14;GOS.o
207IFFF(F)=DD(14);#U=#V+21;GOS.o
2081FO)1;F=F+1-0
210N.
212P."PRESS Y FOR ANOTHER GAME";LI.FF6;IF?#90=89 G.m
217P.$12"GOODBYE";E.
220o#U+7="";P.';S-F,FF(F)," ";#U;O=O+1;R.
300qP.$U;F.F=5 TO 1 S.-1;IFCH#U+F=32 P.$8
305N.;R.
367REM
4001CLEAR0;P.$6$30";?#E0=12;P."YAHTZEE";Y=10
410I.X=6TO60 S.17
415MOVEX,Y;DRAW(X+6),(Y+4);DRAWX,(Y+8);DRAW(X-6),(Y+4);DRAWX,Y

```

YAHTZEE



```

420DRAWX,(Y-8);DRAW(X+6),(Y-4);DRAW(X+6),(Y+4);MOVE(X-6),(Y+4)
425DRAW(X-6),(Y-4);DRAWX,(Y-8);MOVEX,(Y+4);DRAWX,(Y+4)
430MOVE(X-4),Y;DRAW(X-4),Y;MOVE(X-2),(Y-4);DRAW(X-2),(Y-4)
435MOVE(X+4),Y;DRAW(X+4),Y;MOVE(X+2),(Y-4);DRAW(X+2),(Y-4)
440MOVE(X+3),(Y-2);DRAW(X+3),(Y-2);N.;IFY=38 G.450
445Y=38;G.410
450F.X=0TO250;WAIT;N.;G.m
470AP.530';?#E0=28;P."A-"A';?#E0=28;P."B-"B';?#E0=28
471P."C-"C';?#E0=28;P."D-"D';?#E0=28;P."E-"E';R.
480=FF(1)=A;FF(2)=B;FF(3)=C;FF(4)=D;FF(5)=E;G=0;F.W=0TO2
483F.B=1TO4;F.C=B+1TO5;IFFF(B)=FF(C) FF(C)=FF(C)+8
485IFFF(B)(FF(C) G.k
488D=FF(B);FF(B)=FF(C);FF(C)=D
489kN.;N.;N.
492IF FF(1)+1=FF(2) AND FF(2)+1=FF(3);IFFF(3)+1=FF(4) G.j
494IF FF(2)+1=FF(3) AND FF(3)+1=FF(4);IFFF(4)+1=FF(5) G.j
496R.
498;G=2;IFFF(4)+1=FF(5) AND FF(1)+1=FF(2);G=1
499R.
573REM SORT
600K=0;IFEE(X))-1;G.w
602IFB=X;K=K+X
603IFC=X;K=K+X
604IFE=X;K=K+X
607IFA=X;K=K+X
608IFD=X;K=K+X
645EE(X)=K;EE(0)=EE(0)+EE(X)
650c GOS.b;G.d
740IFEE(7))-1 G.w
741EE(7)=0;IFA=B;IFB=C OR D=B OR B=E;G.r
745IFD=E;IFA=D OR B=D OR C=D;G.r
746IFC=E;IFB=C OR A=C;G.r
747IFC=D;IFA=C OR B=C;G.r
749G.c

```

```

758rEE(7)=A+B+C+D+E;G.c
760IFEE(8))-1 G.w
761EE(8)=0;IFA=B AND B=C;IFA=D OR A=E;G.t
763IFC=D AND D=E;IFC=A OR C=B;G.t
766IFA=B AND B=D AND D=E;G.t
768G.c
772tEE(8)=A+B+C+D+E;G.c
780IFEE(9))-1G.w
781EE(9)=0;GOS.s;IFG=1 OR G=2;EE(9)=30
783G.c
800IFEE(10))-1G.w
801EE(10)=0;GOS.s
802IFG=1;EE(10)=40
805G.c
820IFEE(11))-1G.w
821EE(11)=0;IFA=B;G.834
824IFB=C;IFC=E;IFA=D;G.p
827IFB=C;IFC=D;IFA=E;G.p
828IFB=C;IFD=E;IFA=D;G.p
829IFA=D;IFD=C;IFB=E;G.p
830IFB=D;IFC=E;IFA=C;G.p
831IFB=D;IFD=E;IFA=C;G.p
833G.c
834IFB=C;IFD=E;G.p
835IFB=E;IFC=D;G.p
836IFB=D;IFC=E;G.p
837IFD=E;IFC=D;G.p
838G.c
839pEE(11)=25;G.c
840IFEE(12))-1G.w
841EE(12)=0;IFA=B;IFA=C;IFA=D;IFA=E;EE(12)=50
845G.c
860IFEE(13))-1G.w
861EE(13)=A+B+C+D+E;G.c

```

GAMES MACHINE

And now for something completely different...

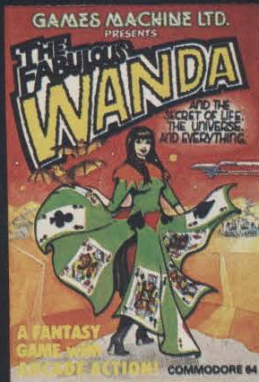

THE FABULOUS WANDA AND THE SECRET OF LIFE THE UNIVERSE AND EVERYTHING

An adult fantasy game with Arcade Action

You are travelling far from home looking for good times around the Universe, when you are intercepted by the evil Brutus of the Federation. Brutus forces you to go and seek the Secret of Life, the Universe and Everything - known only to the Fabulous Wanda, a hostess in the Spaced-Out Inn in Highsville on the planet COPUS. You are teleported down to Highsville where the Customs man demands money for Teleport Tax.

There is a video game in the Terminal with 3 credits left.

Now you are on your own and you must decide how to proceed to Highsville Mainstreet to find the various establishments to enter and

£7.95

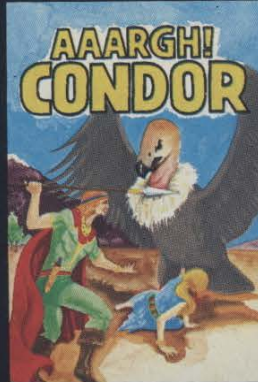

AAARGH! CONDOR

George falls into a day-dream whilst sitting comfortably in his armchair smoking his pipe.

A scene floats in front of him of a landscape with trees and a mountain in the background. A damsel lies helpless having fallen down the mountainside. A strange vulture-like bird is flying down to seize the damsel and carry her off. The damsel is now becoming hysterical and frantic with fear - George knows what he has to do

George at once becomes the hero but he has many hazards to overcome including deadly arrows from the local warrior, deadly creatures and eggs carefully aimed from the air. Can George make it to the top of the mountain to take the spear and kill the bird? Will George finish the game before he drops his pipe and burns the house down?!

£7.95

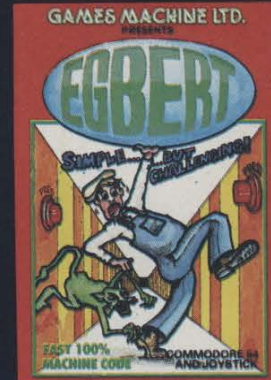

EGBERT

A fast Arcade Action Game for all the family to play. Written in 100% Machine Code for super-fast action!

Egbert works on the production line at 'LEYSPEACE'. It was a comfortable life until the invasion of the TEBBITES from the planet TOR. Egbert's union has been exterminated and the Tebbites have left their deadly Pets running wild in the workplace. As if that wasn't enough, the evil invaders have forced Egbert to take care of an Egg - damaging the Egg will have fatal consequences for poor Egbert. Egbert is now on piecework - can he earn a decent wage? Can he even survive? **WARNING!** You may get an ulcer by playing this game.

SIX LEVELS OF SKILL.

ANYBODY WHO CAN DO LEVEL 6 SHOULD WRITE AND LET US KNOW!

£7.95

New and original games for the COMMODORE 64

Also available soon games for STACK LIGHT RIFLE



GAMES MACHINE LTD.

Business and Technology Centre, Bessemer Drive, Stevenage, Herts. SG1 2DX

Telephone: (0438) 316561 Telex: 825824

Please add 50p to cover post and packing.

I enclose a cheque/P.O. payable to GAMES MACHINE LTD., for £

or debit my Access/Barclaycard account no.

Signature

NAME

ADDRESS



	QTY.	£
WANDA		
CONDOR		
EGBERT		
TOTAL		

SEND TO:-
GAMES MACHINE LTD.
FREEPOST
STEVENAGE
HERTS. SG1 2YH

DEALERS AND DISTRIBUTORS REQUIRED. GAMES AND EDUCATIONAL PROGRAMMES WANTED FOR ANY HOME COMPUTERS.

"ADVENTURES INTO IMAGINATION"

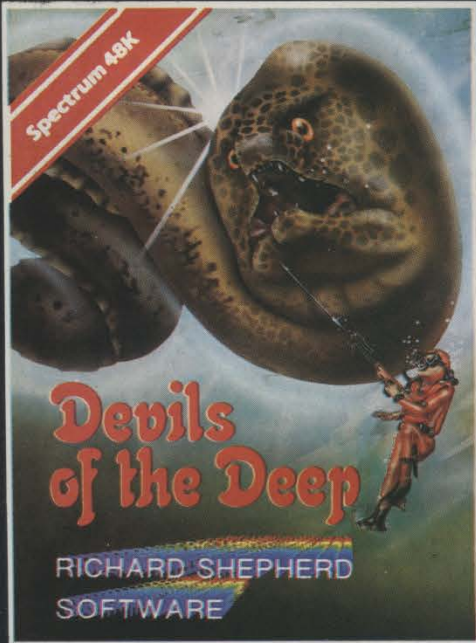

Devils of the Deep

Discover the secrets of Atlantis as you wander amongst its ancient columns. Explore the 100 deadly sectors of its treacherous seabed! Beware of giant eels! £6.50

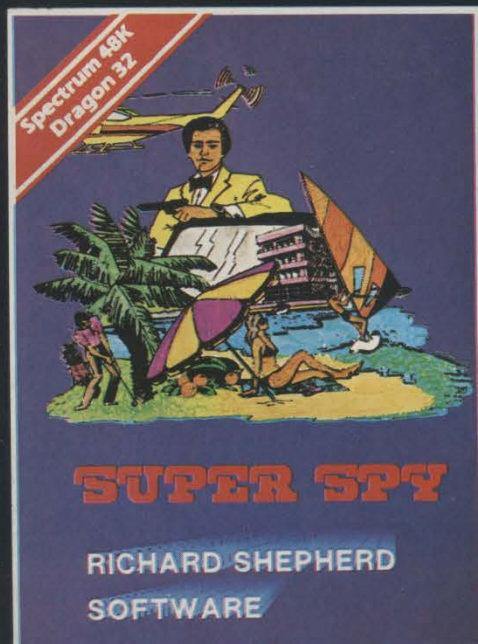

Super Spy

Follow the trail of Dr. Death through complex puzzles, coded messages and 3-D mazes until you find his lair! But beware — even with your death-defying gadgets you may not live to tell the tale! £6.50

CREDIT CARD HOTLINE
06286 63531 (24 HOURS)

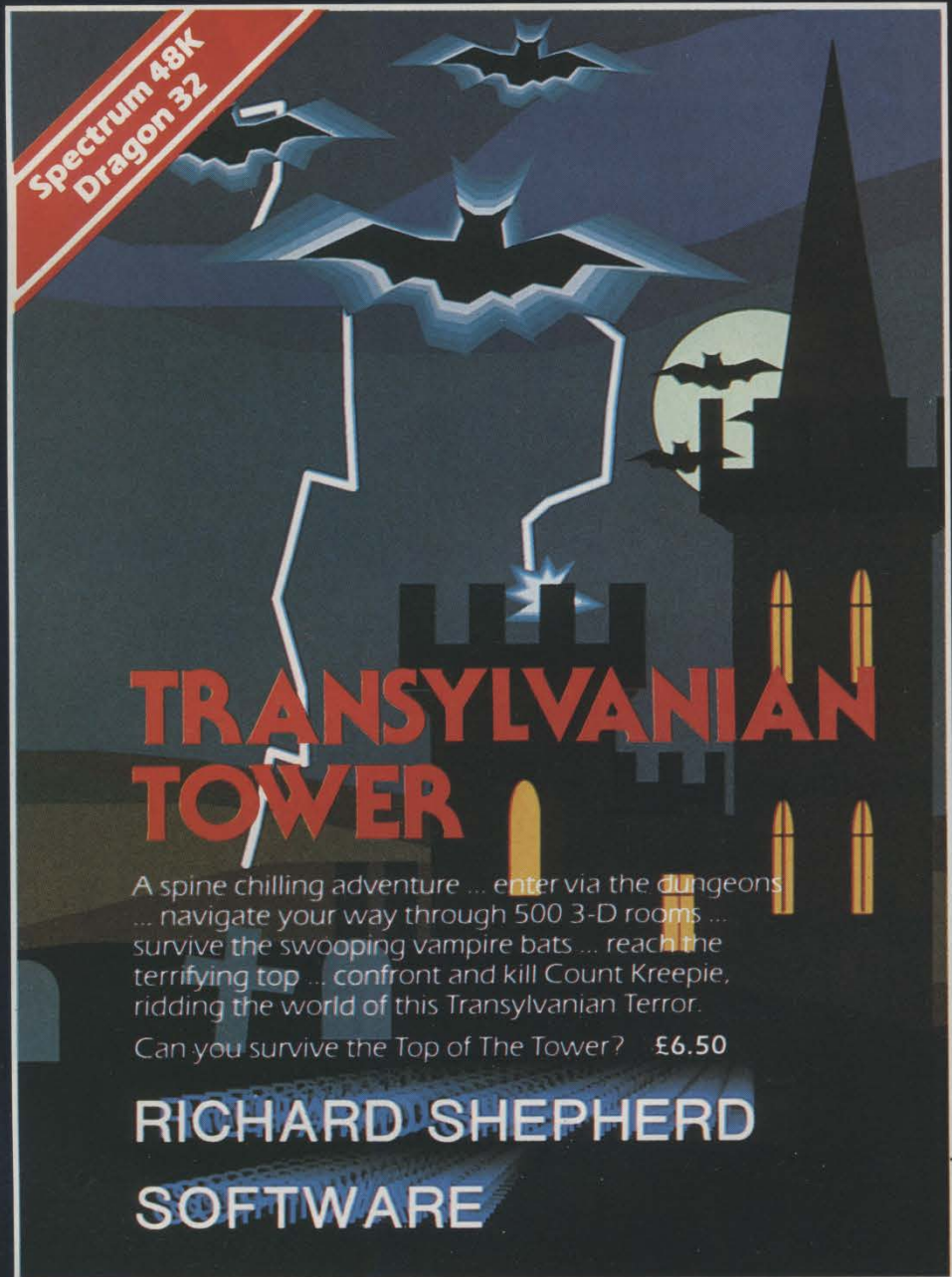

Selected titles available from
W. H. SMITH, BOOTS, MENZIES
AND ALL LEADING COMPUTER STORES

RICHARD SHEPHERD
SOFTWARE

ELM HOUSE, 23-25 ELM SHOTT LANE, CIPPENHAM, SLOUGH, BERKSHIRE.

"ADVENTURES INTO IMAGINATION"

Selected titles available from
**W. H. SMITH, BOOTS, MENZIES
AND ALL LEADING COMPUTER STORES**

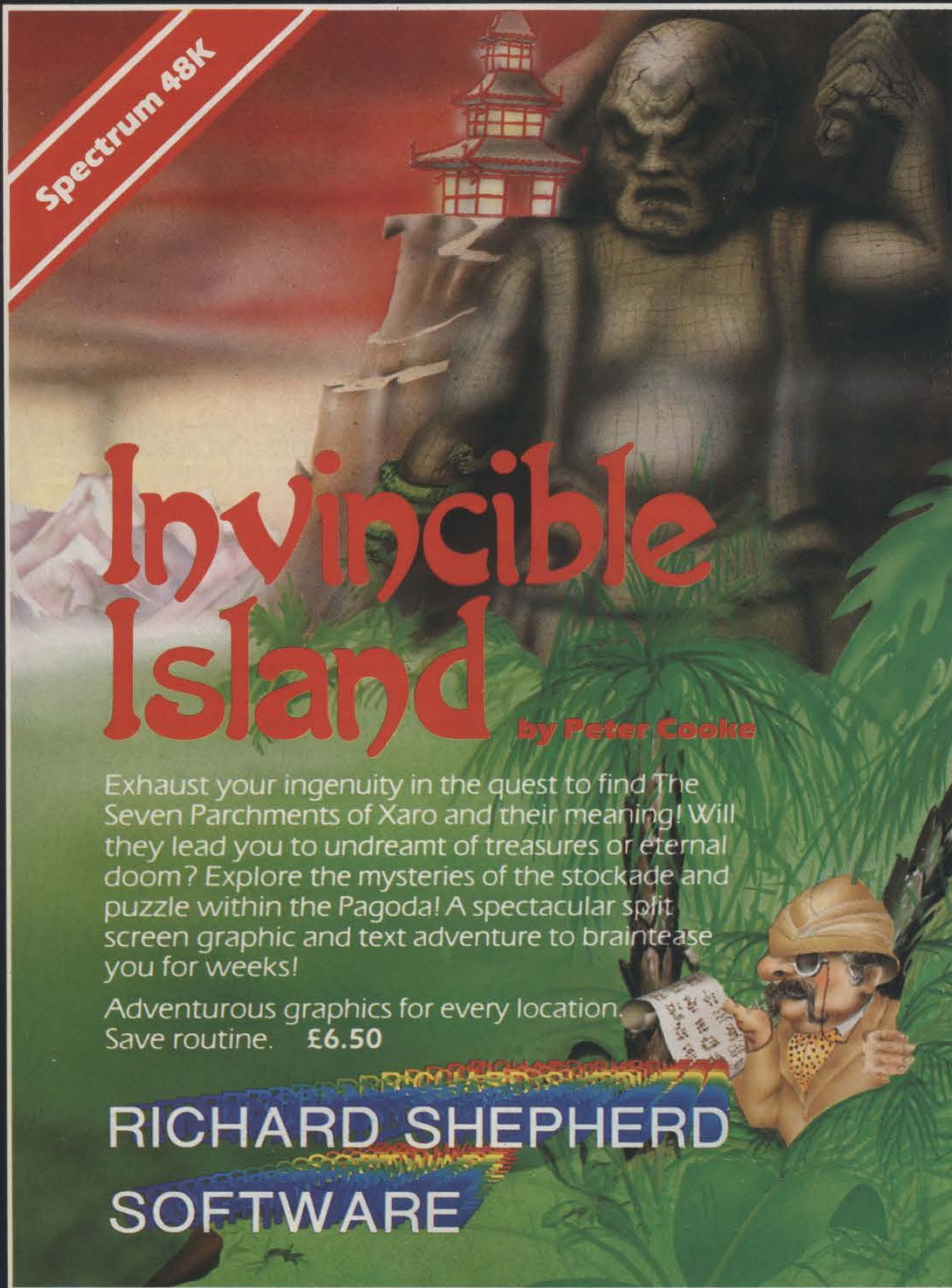

Spectrum 48K

Invincible Island

by Peter Cooke

Exhaust your ingenuity in the quest to find The Seven Parchments of Xaro and their meaning! Will they lead you to undreamt of treasures or eternal doom? Explore the mysteries of the stockade and puzzle within the Pagoda! A spectacular split screen graphic and text adventure to braintease you for weeks!

Adventurous graphics for every location.
Save routine. £6.50

**RICHARD SHEPHERD
SOFTWARE**

**CREDIT CARD HOTLINE
06286 63531 (24 HOURS)**

**RICHARD SHEPHERD
SOFTWARE**

ELM HOUSE, 23-25 ELM SHOTT LANE, CIPPENHAM, SLOUGH, BERKSHIRE.

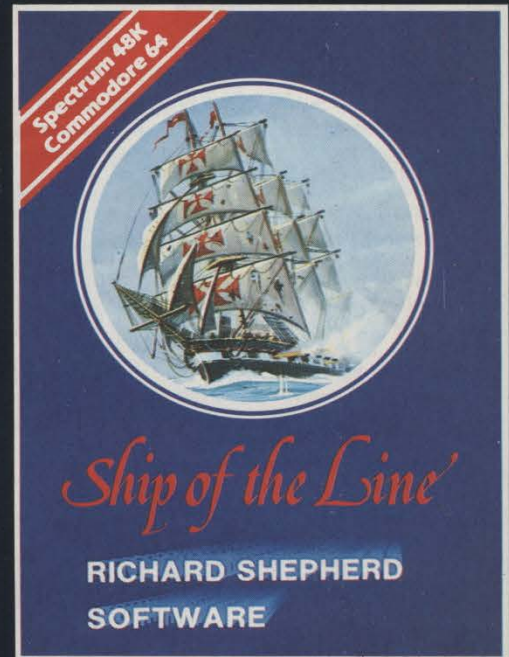

**Spectrum 48K
Commodore 64**

Ship of the Line

**RICHARD SHEPHERD
SOFTWARE**

Ship of the Line

Command a sailing ship, juggle your supplies, crew and firepower. Fearlessly battle your way up the admiralty ladder, bribe Sea Lords as necessary until you make First Sea Lord! £6.50

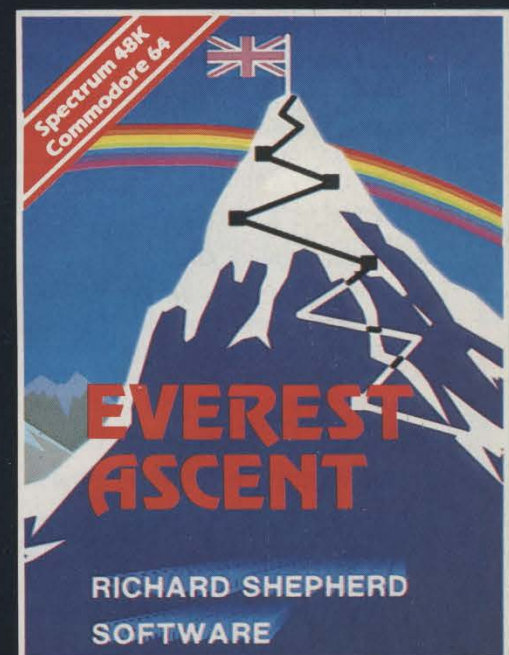

**Spectrum 48K
Commodore 64**

EVEREST ASCENT

**RICHARD SHEPHERD
SOFTWARE**

Everest Ascent

Conquer the world's highest peak in defiance of all the obstacles, man and nature can throw at you. Survive avalanches, cross bottomless crevasses, cope with wayward Sherpas — but don't run out of supplies! £6.50

Mr. CHIP SOFTWARE

SPECTRUM GAMES

SPECTRUM DARTS (48K)

Five games of darts for 1-5 players, 501, Cricket, Killer, Round the board, Noughts and Crosses, four levels of play per game, take on the computer or friends at these games of skill and judgement.....**£5.50**

WHÉLER DEALER

As for the Commodore 64, but now available for the 48K Spectrum, Texas T.I.99/4A and Dragon**£5.50**

VIC 20 GAMES AND UTILITIES

JACKPOT

This is it, the ultimate Fruit Machine for the VIC with nudge, hold and respin 100% machine code. "Overall Jackpot is a beautifully written simulation giving superb graphics, animation and use of colour. In fact, this program makes Commodore's Fruit Machine cartridge look unbelievably cheap and nasty." Home Computing Weekly No. 20 19/7/83.....**£5.50**

KWAZY KWAKS

Accuracy and speed are required for this Shooting Gallery, superb use of colour and graphics in this new and challenging game from the author of Jackpot. 100% machine code, joystick or keyboard control**£5.50**

PACMANIA

Choose your own game from the following options — difficulty 1-3, speed 1-3, size of maze 1-3, visible or invisible maze, still or moving power pills, define your own key controls, any combination, if this is your type of game, then this is the one for you, for the 3K expand. VIC.....**£5.50**

BUGSY (Joystick Only)

This is a Minefield with a difference as you step on the stones whilst collecting purple boxes which give you both time and points, they disappear, from beneath your feet. DO NOT DESPAIR! "BUGSY" will randomly replace the stones but avoid bumping into him or its sudden death! An original compulsive and challenging game**£5.50**

MINI-ROULETTE — PONTOON — HI-LOW

Three great games of chance for the VIC, try to beat the computer, hours of fun, full colour, sound effects and tunes**£5.50**

SUPER BANK MANAGER

A full feature version any memory size, but needs 3K expansion.....**£7.60**

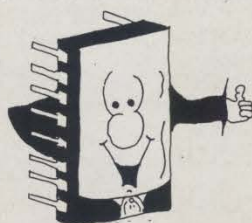

COMMODORE 64 GAMES AND UTILITIES

JACKPOT

At last its here, specially written for the 64, by the author of "JACKPOT" the ultimate Fruit Machine program for the VIC (available from 1st Nov)**£5.50**

WESTMINSTER

A game for up to four players, can you lead the party of your choice and win the general election, you tour the 60 constituencies (seats) buying votes, when you can, (just like the real thing), this must be one of the first board type games specifically written for the computer. Why play on your own, have fun with your family and friends playing WESTMINSTER**£5.50**

RED ALERT

A game for 1-4 players, with sound and graphics. Make money in casinos, commit robbery, hide from the police, hire secret agents, (some of whom can be treacherous), negotiate for weapons, find and attack the secret rocket base to launch the missile, and watch the havoc and destruction caused. There no turning back from "RED ALERT" (available from 1st Nov).....**£5.50**

WHÉLER DEALER

A game for two to twenty players, become a tycoon of the motor trade, you must obtain gearboxes, tyres and engines to produce cars for sale. Form syndicates, buy and exchange parts, buy dealerships, but be careful, you may become bankrupt and have to liquidate, find out what you are made of, have you got what it takes to become a WHÉLER DEALER**£5.50**

LUNAR RESCUE

Our new version, avoid the asteroid belt, to rescue the stranded scientists, then fight your way back to the mother ship, fast reactions are required to safely land and dock your lunar module**£5.50**

CHIPMON

Contains a one- or two-pass Assembler, Disassembler and Monitor. A programming aid for the development of machine code programs and routines on the CBM 64**£12.50**

BANK MANAGER

As our Super Bank Manager but for the 64.....**£7.50**
Now available on disc with added facilities**£10.00**
Full documentation with all utility programs.

PURCHASE LEDGER

Easy to use, single entry, handles 400 invoices per month, Gross/Nett purchases, V.A.T.....**£14.50**
Disk Version (available from 1st Nov)**£17.00**

SALES LEDGER

As above.....**£14.50**
Spectrum.....**£17.50**

Send large S.A.E. for free colour brochure including Rabbit Software at **£5.00**.

MR CHIP SOFTWARE
Dept GC, 1 NEVILLE PLACE, LLANDUDNO,
GWYNEDD LL30 3BL. Tel: 0492 49747

GAMES COMPUTING

Lineage: 35p per word.

Semi display: £8.00 per single column centimetre
Ring for information on series bookings/discounts.

All advertisements in this section must be prepaid.
Advertisements are accepted subject to the terms and conditions printed on the advertisement rate card (available on request).

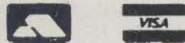

01 - 437 0699
end your requirements to: **SALLY COLLINS, ASP Ltd, 1 Golden Square, London W.1.**

NEW ADDRESS: from 19th Dec. 1 Golden Square, London W.1.

ACCESSORIES

DUST COVERS

VIC 20/64 DRAGON 32 ATARI 800 BBC A & B. ELECTRON, SPECTRUM CASS UNIT C2N (old model) C2N1530 & ATARI in natural quality vinyl. Just send £2.95 (Spectrum £1.50) or £3.95 to inc. cass. cover, staning computer and cassette mode. (No stamp required.)
Cassette cover only £1.50 to:

ALLEN ENTERPRISES
Freepost, Dept GC, Luton LU2 8BR.

ATARI SPARES

Stronger replacement joystick handle inserts. Arcade quality. £2.50 per pair.
Joystick handle top fire button kit. Gives dual firing & left or right hand control. £2.95 each.
48K Ram board. £59.95. All post free.

Computer Supplies (GC)
146 Church Road, BOSTON, Lincs PE21 0JX.

SERVICES

ALL YOUR CASSETTE NEEDS

Blank cassettes C15 with case, 40p each.
Labels in Blue, White or Yellow, 20 for 36p. Inlay cards in Blue, Red or Yellow 20 for 60p. Library cases, 9p each.
Postage on each complete order 55p. Stonehorn Ltd, GC, 59 Mayfield Way, Barwell, Leicester.

ASP Ltd, 1 Golden Square, London W.1. Tel: 01 437 0699

NATIONWIDE DEALERS

LANCASHIRE MICROS

BBC, Sinclair, Commodore, Oric, Dragon and Lynx personal computers. Also the widest range of software, books and accessories in the area.
51 Queen Street, Morecambe, Lancs. Tel: 0524-411435. Also open Sundays.

SOFTWARE GAMES

DRAGON/32 BBC MODEL/B ELECTRON ATARI 400/800 TRS80 C/C-32K 747 FLIGHT SIMULATOR

Superbly realistic instrumentation and pilot's view in lifelike simulation which includes emergencies such as engine fires and systems failures. This program uses high resolution graphics to the full to produce the most realistic flight-deck display yet seen on a home computer. There are 21 real dials and 25 other indicators (see diagram). Your controls operate throttle, ailerons, elevators, flaps, slats, spoilers, landing gear, reverse thrust, brakes, etc. You see the runway in true perspective. Uses joysticks and includes options to start with take-off or random landing approach. "A real simulation, not just another game." (Your Computer Apr 83).
Cassette £9.95 (PP and VAT included)

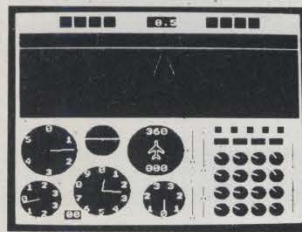

ACTUAL SCREEN PHOTOGRAPH

D.A.C.C. Ltd. (Dept GC) 23 Waverley Road, Hindley, Gr. Manchester WN2 3BN

LOOK!

15% discount on well known Games for **Dragon 32** and **Oric** e.g. **Hobbit** £12.71, **Hungry Horace** £5.06
SAE for list to:

C C SOFTWARE
212 Brays Road, Sheldon, Birmingham B26 2BB.

CLUBS

FREE ARCADE GAME

When you join Nationwide Computer Club. Software exchange, monthly newsletter, discounts, pen pals. SAE for details: **N.C.C. (GC), 12 York Close, Barton, Bedfordshire MK45 4QB.**

VIC 20 SOFTWARE

VIC 20 — CBM 64 — ATARI SHARP — SINCLAIR
Hardware & Software

Many special offers. For catalogue/price list SAE

PANDA SOFTWARE
Rooms 1-2, 2nd Floor,
315-319 High Street,
Chatham, Kent.

ZX81 SOFTWARE

Fawkes Computing

GAMESTAPE 1 (for 16K ZX81)
Four games on 1 cassette! ("A very good cassette," *Which Micro?* Nov '83)
The games are:
Dodge It Eat the dots while avoiding the computer's car (*Dodgems*), m/c.
Trojan Dragon Defend the castle, not as easy as it sounds! ("Offers rather more of a challenge than may at first be apparent," *Which Micro?* Nov '83) m/c
Deathtrap Avoid getting trapped by the computer. (m/c)
Tablets of Hippocrates Adventure game ("By itself, would be worth the £4.95," *Which Micro?* Nov '83.) Answer sheet available.
All the above 4 games on 1 cassette for only £4.95 (all inc.)
Fawkes Computing (Dept GC), 41 Wollridge Ride, Alveston, Bristol BS12 2RA. Tel: (0454) 416706.

ATARI SOFTWARE

SPECIAL OFFER

for Atari 400/600/800 owners
Hire your first 2 games free from our extensive range of software. Up to the minute releases available. Apply now! Send S.A.E. quoting reference G.C. to:

CHARWOOD GAMES
27 Warwick Avenue, Quorn, Leics.
Tel: 0509 412604

FOR HIRE

VIDEOACTIVE Home Computer Rentals

Are you thinking of buying a Home Computer? Not sure which one would suit you best? You could hire an Atari 400/600XL, VIC-20, Commodore 64 or Intellivision System from us for as little as £1.37 per week. We will deliver and collect free (local only) complete with free membership to our expanding software library.

SEND SAE FOR DETAILS TO:
VIDEOACTIVE SOFTWARE
9 Albermarle Gdns, Gants Hill, Essex IG2 6DJ
or Telephone 01-518 6425 (after 4.00 pm or weekends)

WANTED

DELTA SOFTWARE

We are looking for inventive Sinclair/Machine Code programmers. If you think your ideas deserve the best marketing send some of your work on cassette with name, address and telephone number to:
Delta Software, c/o Paul Burke, 56 Knutsford Road, Alderley Edge, Cheshire.

ATARI GAMES

Now you can buy good original software at affordable prices if you're interested in my list or have unwanted programs to sell. Phone 0924 463657 or write (quoting Ref. GC) to:

A. Horton, 5 Ullswater Road, Dewsbury, W. Yorkshire WF12 7PS.

ATARI 400/800 OWNERS

NEW GAMES
Computer Battleships.....£5.95
Mastercode (Mastermind type).....£5.95
Eagleye (Connect-4 type) ..£5.95
Adventure Time (Text Adventure).....£7.95
Why risk losing those precious programs? With our range of utilities you can make a back-up of almost all your software.
Tape backup (single and multi stage).....£9.95
Tape to Disc (Single stage)..£9.95
Disc Copier (inc. bad sectors).....£15.95
Automenu.....£9.95
AWG, 145 Bankside, Westhoughton, Bolton, Lancs.

SELL YOUR GAMES SOFTWARE AND SEE YOUR BUSINESS GROW. CALL GAMES COMPUTING CLASSIFIED ON

01 - 437 0699

TI99/4A SOFTWARE

TEXAS TI99/4A

The software with the reputation. All programmes feature full graphics and sound.

WARGAME Play the computer or another player. Features random terrain, tanks and artillery. Strategy, tactics and real-time skill. Highly recommended **£6.00**

GERMAN WHIST/FOUR IN A ROW. Two programs based on traditional games. Practise trick taking or vertical strategy as you play a clever computer **£6.00**

GRAPHICS PAIRS Based on pelmanism, but with a difference. Use your memory to beat the computer in a crazy car race. The TX skill meter means it is suitable for all ages and abilities **£5.00**

BATTLEFRONT Three arcade-type games but you need the Extended Basic module **£6.00**

ALL PRICES ARE FULLY INCLUSIVE

**TX SOFTWARE, Dept GC,
109 Abbotsweld,
Harlow CM18 6TQ**

LANTERN SOFTWARE TI99/4A

Discover our range of arcade games and utilities. High quality software at New Low Prices.

Daddie's Hot Rod — Drive the hot rod down a twisting road, avoid obstacles and pick up hitch-hikers — **£5.95. Troll King** — First discover your quest, then try to complete it in this excellent 16K adventure — **£5.95. The Black Tower** — Avoid the perils of the Black Tower and rescue the lady Gwen — a superb adventure — **£5.95. Hunchback Havoc** — 24 sheets of action — unequalled in speed and graphics — simply the best — **£5.95**

For a full list of these, our Ext-Basic range and more send S.A.E. to: Dept GC, 4 Haffenden Road, Tenterden, Kent TN30 6QD.

MICROSONIC Programs for the unexpanded TI99/4A

Air Attack	£5.25
Alien Alert	£4.25
Grand Prix	£3.95
Galactic Zoo Keeper	£5.25
Space Vault	£4.50
Hangman and Masterbrain	£4.25

All prices are inclusive. Dealer enquiries welcome. Please send Cheque/PO's to: **MICROSONIC, 85 Malmesbury Road, Cheadle Hulme, Cheshire SK8 7QL.**
REF. GC

TEXAS TI99/4A software. Wide range available from £3.95. Send SAE for list, Apex Software (GC), Swiss Cottage, Hastings Road, St. Leonards-on-Sea, Sussex TN39 8LA.

**FOR ALL YOUR
SPECIALIST
CLASSIFIED
NEEDS
PHONE
01 - 437 0699**

CLASSIFIED ADVERTISEMENT — ORDER FORM

1.	2.	3.
4.	5.	6.
7.	8.	9.
10.	11.	12.
13.	14.	15.

When placing your ad, please state classification required 35p per word.
Send to: ASD Classified, 1 Golden Square, London W.1. Tel: 01 - 437 0699.

Name

Address

Tel.No. (Day)

Please place my advert in **GAMES COMPUTING** for issues commencing as soon as possible.

THE LONDON HOME COMPUTER SHOW

CANCELLED

It's easy
to complain about
an advertisement.
Once you know how.

One of the ways we keep a check on the advertising that appears in the press, on posters and in the cinema is by responding to consumers' complaints.

Any complaint sent to us is considered carefully and, if there's a case to answer, a full investigation is made.

If you think you've got good reason to complain about an advertisement, send off for a copy of our free leaflet.

It will tell you all you need to know to help us process your complaint as quickly as possible.

The Advertising Standards Authority. ✓
If an advertisement is wrong, we're here to put it right.

ASA Ltd, Dept 1 Brook House,
Torrington Place, London WC1E 7HN

This space is donated in the interests of high standards of advertising.

THREE EXCITING NEW GAMES IN THE LIVEWIRE SERIES FOR THE FROM **SUMLOCK** MICROWARE

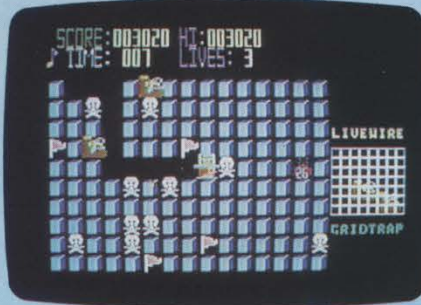
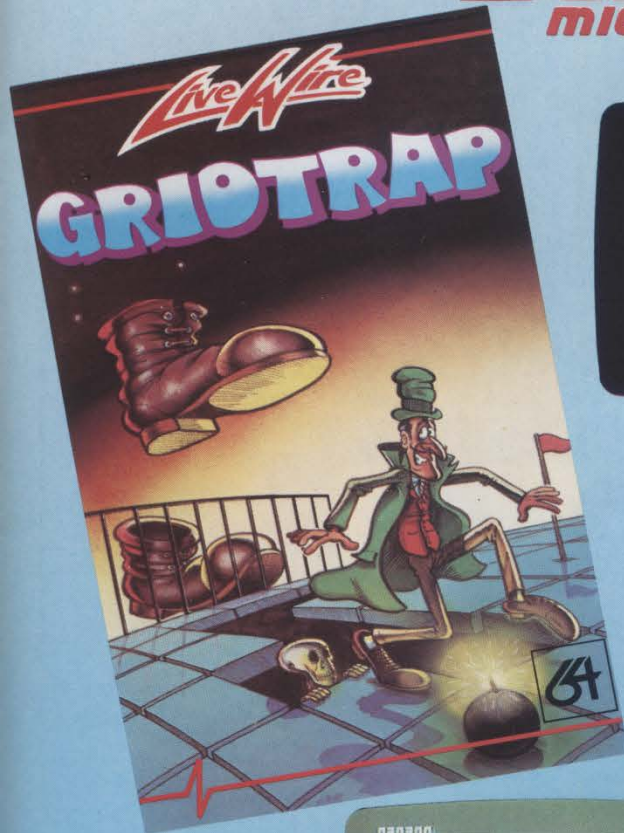

Not just a game... an Experience!
IT HAS IT ALL!... EXCITEMENT...
HUMOUR... STRATEGY

Jumpin' Jack leaps into a totally new look for the 64 created by **Three Dimensional Graphics** giving **Full Perspective** to the game... PLUS... hosts of features never seen before!

Submerging Turtles — Snakes — Crocodiles — Otters — Lady Frog — Dragonfly!!!

It's Fun ***
IT'S FROGGRIFIC ***
Program
No. LW02 £8.95

GRIDTRAP 64

We promise you won't be able to turn it off! It's a real skill tester and loads of fun to play!

Play with the Keyboard or Joystick. Choose your own operating keys with our **User Definable System**. Compete with an opponent by selecting **Two Player Mode**...

Great graphics, super sound effects in the Livewire tradition including a selectable Melody Mode where the tune is available at the touch of a key and Melody On is indicated by a quaver graphic.

Program No. LW04 £8.95

JUMPIN JACK 64



TRIAD 64

NEVER BEFORE HAS A COMPUTER GAME LOOKED SO EXCITING...

...FELT AND PLAYED SO EXCITING...

Watch astounded as the Triad hurl themselves towards your craft in a remorseless battle against your intrusion.

Feel the heat blast of their anti-matter fields.

Your pulse laser will have to turn white hot before this encounter is over...

Featuring:-
A new DIMENSION...

Into the realm of TOTAL PERSPECTIVE GRAPHICS...

Program No. LW03 £8.95



SUPERB SOFTWARE FOR THE VIC 20



SP.04 GRIDTRAP
Defuse the bombs, watch out for the mines and wandering robot. Joystick or Keyboard
M/code £7.95



SP.01 SKRAMBLE
Destroy the enemy installations and missiles in their underground silo. Joystick or keyboard
M/code £7.95



SP.02 JUMPIN JACK
Cross a busy road and treacherous river to get Jack home. Joystick or keyboard.
Hi-Res Gr. M/code £7.95



SP.03 TRIAD Defend your base against the suicide fleets of alien hoverships. Joysticks or keyboard.
M/code £7.95



SP.13 STARSHIP ESCAPE A compelling and exciting real time graphics space adventure game. Joystick or keyboard
M/code £9.95



SP.16 MULTITRON The biggest alien encounter of all time. Wave after wave of invasion action. Joystick or keyboard
M/code £7.95



SP.06 ASTRO FIGHTERS A space duel played by two players at once. Requires Joystick.
M/code £6.95



SP.07 CHOPPER Attack and destroy the enemy base but watch out for guided missiles. Joystick or keyboard.
M/code £6.95

Clip the coupon below and return to Sumlock Microware Dept. GC-S1
198 Deansgate, Manchester M3 3NE.
or Telephone: 061-834 4233



Please send me the following Software

I enclose Cheque/P.O. for £ _____ inc. P + P U.K. only.

To: Name _____

Address _____

Post Code _____

Also available from good computer dealers and bookshops nationwide.

SUMLOCK MICROWARE

Trade enquiries welcome. Trade distribution nationwide ring 061-834 4233 for details.

LIFT OFF with



SPACE SHUTTLE



SPECTRUM LAUNCH STAGE



DRAGON 32 ARM STAGE

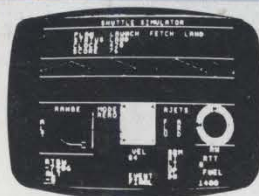

BBC FINAL STAGE

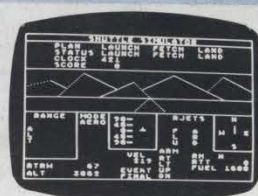

ATARI FINAL STAGE

MISSION BRIEF

Successfully pilot the Shuttle through Launch, Fetch & Finals. Take off and position Shuttle in orbit. Manoeuvre alongside malfunctioning Satellite. Retrieve - then re-enter to glide without fuel to White Sands Desert.

PREVIOUS SUCCESSFUL MISSIONS

EXCELLENT - "Personal Computer News"
 A WELL THOUGHT OUT GAME - "Dragon User"
 ALMOST WORTH BUYING A DRAGON FOR -
 "Which Micro"



MISSION STATUS Available for
 48K ORIC 1, ATARI 16K, DRAGON 32, BBC
 MODEL B, SPECTRUM 48K, COMMODORE 64,
 ACORN ELECTRON, TANDY COLOUR 32K
 CASSETTE £8 DISK £10

Postal Orders to
 41 Truro Road, St. Austell, Cornwall PL25 5JE
 Telephone/Credit Card Order
 Tel: 0726 3456

Available from computer dealers
 nationwide or from larger branches of



MICRODEAL



John Menzies