

POPULAR Computing WEEKLY

THIS WEEK'S SOFTWARE
SEE PAGE 78

35p 24-30 November 1983 Vol 2 No 47

This Week

Sord M5

The Japanese contender in the ferocious under-£200 computer market — Andy Pennell sees how it measures up. See page 46.

Spectrum interrupts

Alan Went shows how simple it is to use Z80 interrupts to improve your own programs. See page 20.

Casio keyboards

These electronic keyboards are flooding the shops — Graham Taylor wonders whether they are computers in disguise. See page 13.

New releases

All the latest software programs including *Four Gates to Freedom* by Phoenix and *Pub Crawl* from B & H Software. See page 76.

★ STAR
Amoeba's Playtime
on 48K Spectrum.
See page 10.
GAME★

News Desk

Acorn contract shoot-out

SINCLAIR Research has announced its intention to challenge Acorn for the BBC computer contract when it comes up for renewal next summer.

"We would be most interested in competing for that contract if it is feasible for us to do so," said a Sinclair spokesman.

As a first step, Sinclair has written to the BBC to discover if the contract is to be offered on open tender. "We want to state our interest openly, well in advance and find out how the BBC wants to handle it.

"So far they have acknowledged our letter and confirmed that they are looking into it," added the Sinclair spokesman.

Acorn remains unruffled by the Sinclair action. "Acorn is not at all worried — there is no reason why it should be — Sinclair tendered for the original contract and lost," explained an Acorn spokesman.

"We would be surprised if
Continued on page 5

Ted revealed at Las Vegas

COMMODORE is expected to show a prototype of its new computer, the Commodore 444, for the first time at the Consumer Electronics Show in Las Vegas in January.

The machine will be the first to use Commodore's new TED chip. The TED is a multi-purpose device, designed to reduce the number of components on the circuit board and thereby reduce manufacturing costs. The TED combines the functions of system controller, video controller, display processor

and voice generator all in one chip. The Commodore 444 will also be the first Commodore machine to use a new updated 6500-family central processor with optimised access to external memory.

The Commodore 444 will be a more advanced machine than the existing Commodore 64 computer with sophisticated cursor control and built-in word processing.

Commodore is also considering a new low-cost machine. Commodore (UK)

Continued on page 5



Classified

Computer Swap
01-437 4343

Free readers entries to buy or sell a computer.
Ring 01-437 4343 and give us the details.

Classified

SHADOW FOR THE BBC 32K

Shadow will allow you to make security back-ups of your valuable tape software.
★ Any OS ★ 100% machine code ★ Basic I and Basic II ★ 1200 + 300 baud ★ "Locked" programs
★ Files ★ Any length ★ Easy to use.
Shadow works with 99% of all known programs including "locked" programs or those containing sections at 300 baud.
FREE Inspector a very useful memory viewing program which displays memory in colour coded sections for ease. Worth £8 on its own. Shadow + Inspector £8 inclusive.
Cheque to:

Clares Micro Supplies
Dept PCW, 222 Townfield Road, Winsford, Cheshire
Tel: (06065) 51374

48K SPECTRUM Football Manager. Features: 88 teams, match commentary, divisional scoreboard, promotion, relegation, injuries plus more! Only £2.99 (also on Vic20 plus 8K CBM64). D. Spencer, 230 Lowgrange Avenue, Billingham, Cleveland.

MICRODRIVE CARTRIDGE PROGRAMS. Ten great programs from Arcade Action to mind-boggling puzzles; all on one Spectrum Microdrive cartridge for only £9.95 including p&p from Totlwood Software, Mill Lane, High Salvington, Worthing, Sussex.

Classified

DRAGON 32 ADVENTURE GAMES. PYRAMID, can you beat the Pharaoh's curse? ESPIONAGE, break into MI5's headquarters, if you can! £4.95 each. Exodus, 36 Penrice Drive, Tividale, Warley, West Midlands.
CARRIERS AT MIDWAY. Definitive simulation of key Pacific battle; solo or two-player. Strikes, reconn, surface action, graphic combat, 48K Spectrum, £9.95. To: Specsims, 59 Chestnut Road, London SE27 9EZ.
VIC20 OWNERS. Test your IQ. Unexpanded Vic20 assesses your intelligence level plus free space duel, only £3.75. Spall, 26 Melford Way, Felixstowe, Suffolk.

Continued on page 69

VALHALLA

BRITAIN'S BEST-SELLING MICRO WEEKLY

MR CHIP SOFTWARE

SPECTRUM GAMES

SPECTRUM DARTS (48K)

Five games of darts for 1-5 players, 501, Cricket, Killer, Round the board, Noughts and Crosses, four levels of play per game, take on the computer or friends at these games of skill and judgement £5.50

WHEELER DEALER

As for the Commodore 64, but now available for the 48K Spectrum, Texas T.I.99/4A and Dragon £5.50

VIC 20

GAMES AND UTILITIES

JACKPOT

This is it, the ultimate Fruit Machine for the VIC with nudge, hold and respin 100% machine code. "Overall Jackpot is a beautifully written simulation giving superb graphics, animation and use of colour. In fact, this program makes Commodore's Fruit Machine cartridge look unbelievably cheap and nasty." Home Computing Weekly No. 20 19/7/83 £5.50

KWAZY KWAKS

Accuracy and speed are required for this Shooting Gallery, superb use of colour and graphics in this new and challenging game from the author of **Jackpot**. 100% machine code, joystick or keyboard control .. £5.50

PACMANIA

Choose your own game from the following options — difficulty 1-2, speed 1-3, size of maze 1-3, visible or invisible maze, still or moving power pills, define your own key controls, any combination, if this is your type of game, then this is the one for you, for the 3K expand. VIC only £5.50

SNAKE BYTE

Guide your ever hungry snake round the screen, eating the flies and wasps, to stay alive you must avoid the deadly mushrooms, quick reactions are required for this biting game, keyboard control, for the unexpanded VIC £5.50

BUGSY (Joystick Only)

This is a Minefield with a difference as you step on the stones whilst collecting purple boxes which give you both time and points, they disappear from beneath your feet. **DO NOT DESPAIR!** "BUGSY" will randomly replace the stones but avoid bumping into him or its sudden death! An original compulsive and challenging game £5.50

MINI-ROULETTE — PONTOON — HI-LOW

Three great games of chance for the VIC, try to beat the computer, hours of fun, full colour, sound effects and tunes £5.50

DATABASE — create your own files and records on tape £7.50

SUPER BANK MANAGER — A full feature version any memory size, but needs 3K expansion £7.50

COMMODORE 64

GAMES AND UTILITIES

WESTMINSTER

A game for up to four players, can you lead the party of your choice and win the general election, you tour the 60 constituencies (seats) buying votes, when you can, (just like the real thing), this must be one of the first board type games specifically written for the computer. Why play on your own, have fun with your family and friends playing WESTMINSTER £5.50

WHEELER DEALER

A game for two to twenty players, become a tycoon of the motor trade, you must obtain gearboxes, tyres and engines to produce cars for sale. Form syndicates, buy and exchange parts, buy dealerships, but be careful, you may become bankrupt and have to liquidate, find out what you are made of, have you got what it takes to become a WHEELER DEALER £5.50

LUNAR RESCUE

Our new version, avoid the asteroid belt, to rescue the stranded scientists, then fight your way back to the mother ship, fast reactions are required to safely land and dock your lunar module £5.50

PONTOON — ROULETTE — ACE'S HIGH — More powerful versions, that make three great games of chance for the 64..... £5.50

CHIPMON

Contains a 1 for 2 pass assembler/disassembler and monitor, a programming aid for the development of machine code programs and routines on the CBM

64..... £12.50

BANK MANAGER — As our Super Bank Manager, but for the 64 £7.50

Now available on disc with added facilities £10.00

Full documentation with all utility programs.

Other software available for the VIC and Commodore 64, send for free brochure, including **RABBIT SOFTWARE** at £5.50 each.

Send Cheques/PO's to:

MR CHIP SOFTWARE

Dept POP, 1 NEVILLE PLACE,
LLANDUDNO,
GWYNEDD LL30 3BL. Tel: 0492 49747

Wanted: High quality software,
of all types, for export and UK distribution
All programs now available on disc please allow £2.50
extra.

DEALER ENQUIRIES WELCOME

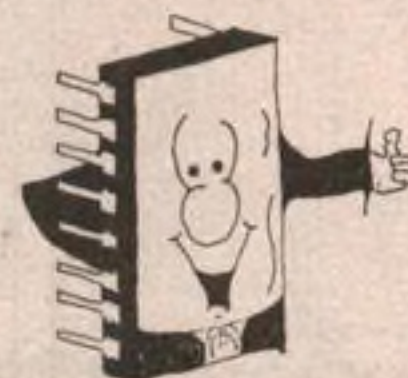

The Team

Editor
Brendon Gore

News Editor
David Kelly

Software Editor
Graham Taylor

Production Editor
Lynne Constable

Editorial Secretary
Cleo Cherry

Advertisement Manager
David Lake

Advertisement Executive
Alastair Macintosh

Classified Executive
Diane Davis

Advertising Production
Lucinda Lee

Administration
Theresa Lacy

Managing Editor
Duncan Scot

Publishing Director
Jenny Ireland

Popular Computing Weekly,
12-13 Little Newport Street,
London WC2R 3LD
Telephone: 01-437 4343

Published by Sunshine Publications Ltd.
Typesetting, origination and printing by
Chesham Press, Chesham, Bucks
Distributed by S M Distribution
London SW9. 01-274 8611. Telex: 261643
© Sunshine Publications Ltd 1983



Registered at
the Post Office
as a newspaper

MEMBER OF THE AUDIT
BUREAU OF CIRCULATIONS
ISSN 0265-0509

How to submit articles

Articles which are submitted for publication should not be more than 3,000 words long. The articles, and any accompanying programs, should be original. It is breaking the law of copyright to copy programs out of other magazines and submit them here — so please do not be tempted.

All submissions should be typed and a double space should be left between each line. Please leave wide margins.

Programs should, whenever possible, be computer printed.

We cannot guarantee to return every submitted article or program, so please keep a copy. If you want to have your own program returned you must include a stamped, addressed envelope.

Accuracy

Popular Computing Weekly cannot accept any responsibility for any errors in programs we publish, although we will always try our best to make sure programs work.

This Week

News	5
Oric drives, Magic desk	
Letters	7
Ant attack winner	
Star Game	10
Amoeba's Playtime on 48K Spectrum	
Street Life	13
Graham Taylor talks to Casio	
Reviews	16
Dragon enhancements	
Programming	18
4-terminal networks	
Spectrum	20
Interrupts by Alan Went	
BBC & Education	26
Cosmic Lander by Michael Pearce	
Dragon	31
Rom calls by Bernice Hennessy	
Commodore 64	36
Sid chip by Pete Gerrard	
Reviews extra	46
Andy Pennell looks at the Sord	
Open Forum	48
Eight pages of your programs	
Microradio	61
Ray Berry looks at morse tutors	
Adventure	65
Tony Bridge's corner	
Peek & Poke	67
Your questions answered	
New releases	76
Latest software programs	
This week	78
Top 10 plus all this week's software	
Competitions	79
Puzzle, Ziggurat, Losers	

Editorial

Acorn's contract to produce the BBC micro comes up for renewal next year.

Although there is little likelihood of the BBC taking the contract away from Acorn — despite initial production problems, the BBC micro has lived up to most expectations — other micro manufacturers, notably Sinclair, Dragon, Oric and Computers, are itching to tender for the contract. Sinclair, in particular, is eager to prove that the BBC made the wrong decision in selecting Acorn for the original contract.

Whatever the outcome of the BBC contract, there is also the intriguing possibility of a rival micro being launched by the independent television companies. The ITV networks are all too well aware of the lucrative spin-offs which the BBC has derived from its association with micros. It would be a natural move, though there is a lot of leeway to be made up, for the ITV companies to launch their own computer.

The ITV micro is not a new idea — Commodore has already had informal talks with at least one commercial station on the feasibility of producing just such a machine. However, any ITV micro would face problems unbeknownst to its BBC sibling.

For an ITV micro to have any hope of success, it would need to be embraced by all the independent tv companies, not just a proportion of them. This, in turn, would necessitate all the companies agreeing to common specifications for the micro.

Next Thursday

Can you find the hidden treasure in Diver — next week's Star Game for the Spectrum by John Durst.

Subscribe to Popular Computing Weekly

I would like to subscribe to *Popular Computing Weekly*.
Please start my subscription from the issue.

UK Addresses: 26 issues at £9.98 52 issues at £19.95
Overseas Addresses: 26 issues at £18.70 52 issues at £37.40
Please tick relevant box
I enclose my cheque to *Popular Computing Weekly* for.....

Name

Address

Please send this form, and cheque, to *Popular Computing Weekly*, Subscription Dept., 12-13 Little Newport Street, London WC2R 3LD.

QUALITY PRODUCTS

Distributed solely by:

PSL MARKETING

52 LIMBURY ROAD, LUTON, BEDS. LU3 2PL.
Telephone: LUTON (0582) 591493

COMMODORE CASSETTE INTERFACE

Our Interface has been designed to allow low cost cassette tape recorders to operate with either the Commodore 64 or Vic20 in exactly the same way as the Commodore C2N.

As each type of tape recorder is different, our unit is equipped with a switch system which enables it to be made compatible with most tape recorders.

Included with each unit is a comprehensive instruction manual.

Priced at only £16.99 (inc VAT and P&P)

LOGIC-PLAN PROGRAMMING AIDS FOR THE MICRO-COMPUTER

GRAPHIC PLANNING GRIDS. Each grid is designed for use with specified micro-computers, and is a lost cost aid to programmers wishing to develop their skills in designing high resolution graphic displays. Grids are marked on all four sides with pixel co-ordinates, appropriate to each computer for which they are available (Atari, BBC, Commodore 64, Dragon 32, Oric, Spectrum, Tandy and Texas). An ideal aid for beginner and expert alike, and cost **£2.99 each (inc VAT and P&P).**

AUDIO BOXES

Strongly constructed PVC "Book type" Audio Boxes hold 1 or 2 cassettes, including the plastic case. Gives dust-free storage, avoids light contamination of tapes and will enable you to build up a library of your favourite programs. Sold in packs of 3.

Single size (holds 1 cassette) £1.99 per pack

Double size (holds 2 cassettes) £2.99 per pack

cable software

GREAT GAMES FOR THE DRAGON

TRACE RACE

Race your Light Cycle around the Games Grid. Force your opponent into a Power Trace or into the Grid wall to win. A game for two players with joysticks, or can be played by a single player as TRACE RACE (SOLO) — one joystick required.

BACCARAT

Bring Casino quality gambling into your living room with BACCARAT, the game played by the rich and famous. See if you can break the bank at Monte Carlo!

CAVE FIGHTER

At last a superb 100 per cent machine code 'Scramble' type arcade game, complete with fast scrolling, high-resolution colour graphics and sound.

DRAGRUNNER

Frogger type game with a difference. Help our hero Super Sleuth Sidney make as many safe journeys across the conveyors as he can, using his Smith & Wesson MK 12 to shoot the patrolling Laser Droids.

DRONE

A graphic 3D simulation game, taking place inside your Dragon. Equipped with your MK Type Datatank, you must search out and destroy the evil Rom Guardian. At your disposal are Logic Cannons, Pulse Laser, Proximity Detectors, Thrusters, Brakes and on-screen sighting system.

All Games cost £8.75 (inc P&P and VAT)

SPECIAL CHRISTMAS PROMOTION FOR DRAGON AND ORIC OWNERS EXTRA VALUE SOFTWARE PACK WITH TWO GREAT GAMES FOR ONLY £9.99 (inc VAT and P&P)

For the Dragon 32 (Super ACTION Pack)

DRAGON RACER is a game which brings the excitement found in Formula One racing into your home.

As Star Driver for Team Micro, you must clock up as many miles as you can without crashing or blowing up your engine.

Your four-gear race-tuned engine is capable of great speeds — but watch your revs . . . over 12,000 rpm and your race will be prematurely ended.

WASP INVASION is a 100% machine code "Arcade Style" game demanding quick thought and actions. As you defend your planet against the multi-wave Wasp attackers, who will drop bombs and suicide dive on to your outposts!

At your disposal is a joystick controlled Laser Base, which is used to thwart the attacks by moving and firing skyward.

For the Oric 48K (Great ADVENTURE Pack)

TEVROG'S KINGDOM II. A real time adventure for the Oric which uses virtually all available memory of the computer due to its complexity. Your task is to identify, find and acquire the Magic Talisman of King Tevrog. To do this you will need to search throughout the kingdom to locate the Talisman, avoiding all the dangers to find the clues necessary to make your search successful.

You can travel through caves and buildings, meet enemies and allies, find clues and cast spells, but although the layout of the kingdom and its buildings is fixed, little else is.

A unique concept in an Adventure Game which makes Tevrog's Kingdom II a compulsive challenge for all adventure fans.

QUEST FOR POWER. Explore the cave system inhabited by Trolls, Ogres and Balrogs. Avoid these creatures whilst acquiring magic charms and weapons to improve your chance of survival.

Once you have collected sufficient objects, you must attack and destroy the weaker creatures (Trolls and Ogres, in that order) before you can tackle the dreaded Balrogs to capture the Ring of Power.

EACH PACK CONTAINS TWO CASSETTES IN DOUBLE SIZE BOOK TYPE PACKAGE
MAKING AN IDEAL PRESENT. GREAT VALUE AT ONLY £9.99 (inc VAT and P&P)

TROJAN LIGHT PENS

The Trojan Light Pens have received great reviews throughout the computer trade and are undoubtedly the finest light pens available for Spectrum and Dragon owners.

The advanced software enables you to draw pictures on to your TV screen, create your own designs and save and reload from tape. No experience of programming is necessary as the Trojan Pen comes complete with a new advanced program cassette and comprehensive instructions.

Each Trojan Light Pen gives the user the following facilities in HI-RES:

• DRAW PICTURES FREEHAND; • DRAW BOX; • DRAW CIRCLE; • DRAW LINE; • COLOUR FILL DESIGNATED AREAS.

ALL FUNCTIONS IN FOUR COLOURS FOR THE DRAGON. ALL FUNCTIONS IN EIGHT COLOURS ON THE SPECTRUM.

Available in text: • DATA ENTRY AND PROCESSING; • MENU SELECTION AND CONTROL; • GAMES PLAYING.

Also programming hints and tips.

The Spectrum 48K Light Pen is only £17.25 (inc VAT and P&P). The Dragon 32 Light Pen is only £11.50 (inc VAT and P&P).

The Trojan Light Pen can be obtained direct from PSL Marketing or from the manufacturers:

TROJAN PRODUCTS, 166 DERLWYN, DUNVANT, SWANSEA SA2 7PF

ALL DEALER ENQUIRIES SHOULD BE MADE DIRECT TO PSL MARKETING

SEND ORDERS TO PSL MARKETING, FREEPOST, LUTON LU3 2BR (NO STAMP REQUIRED)

Please supply me with:

- Trace Race £8.75
 Baccarat £8.75
 Cave Fighter £8.75
 Dragranner £8.75
 Drone £8.75
 Dragon Double Pack £9.99
 Oric Double Pack £9.99

- CBM Cassette Interface £16.99
 Pack of single Audioboxes £1.99
 Pack of double Audio Boxes £2.99
 Logic Plan Grids £2.99
 State Computer
 Dragon 32 Light Pen £11.50
 Spectrum Light Pen £17.25

Name

Address

Rival Oric disc drive from ITL

ITL, in Chatham, hopes to do for Oric what Premier Microsystems did for Dragon.

This week the company will launch a rival disc drive system to Oric's own, before the official Oric product has even appeared.

Like the Oric Products disc unit, the ITL system — called the Byte Drive 500 — is based on the Hitachi 3 inch drive. It is a 40-track single unit giving a formatted memory capacity of about 440K. A double-sided 80-track version is also on the way.

The Byte Drive 500 comes with its own power supply, capable of handling up to two disc units. The interface to connect the system to the Oric 1 computer takes the form of a custom chip that has been built into the connecting cable linking the disc drive and computer.

ITL's own disc operating

system is supplied on disc and works as an extension to the existing Oric Basic. Connecting the drive simply adds a number of new commands to the Basic vocabulary.



Peter Halford

The system has been designed for ITL by Tyrell Computer Systems. The design work of the ULA custom chip and DOS has been undertaken for Tyrell by Peter Halford, one of the original team of four which designed the Oric

facilities.

Commodore announced *Magic Desk*, a series of 32K Rom software cartridges for the Commodore 64.

Magic Desk provides, on-screen, a pictorial representation of an office. Using a joystick, a screen cursor can



be directed around the picture. By pointing at different parts of the office display and pressing the joystick 'fire' button, different options can be selected: pointing to the filing cabinet gives file handling, pointing to the typewriter gives word-processing.

The first *Magic Desk* cartridge, *Magic Desk 1 - Type and File* has recently gone on sale in the US, priced under \$100. It contains the word-processing and information filing software.

However, *Magic Desk 1* has 1981, its turnover has increased more than 30-fold. In the year ended June, 1981, turnover amounted to £1.36m., considerably less than the £42.355m. recorded in the year ended June, 1983.

1. He left Oric earlier this year.

The ULA for the disc system is being manufactured for ITL by California Devices, the Company which manufactures the ULA in the Oric 1.

The Byte Drive 500, plus power lead, is priced at £167.28. The power supply unit is £25.93 and the connecting cable, interface and operating system disc are £86.45.

ITL is currently looking for high-street distribution for the Byte Drive 500.

The first systems should go on sale by mail-order in early December. More details from ITL, The Old Courthouse, New Road, Chatham, Kent.

● The first batch of Oric's own 3 inch disc drives, originally planned for delivery in the summer, are not expected until mid-December. Bulk deliveries are not scheduled until 1984.

not been greeted very enthusiastically by Commodore UK.

"We will probably go ahead with *Magic Desk 2* rather than *Magic Desk 1* — it's a better program," explained Commodore UK's marketing manager John Baxter.

Magic Desk 2 is similar to *Magic Desk 1* except it offers additional calculator and home budget software facilities. *Magic Desk 2* is unlikely to appear in the UK until early in 1984.

Software incompatibility



ALTHOUGH IBM claims that the majority of programs available for the PC will run directly on its new low-cost PCjr, only a small proportion will run directly on the entry model (\$669) version of the machine.

Most of the programs for the PCjr require the more advanced operating system offered by the 2.1 disc operating system of the expanded model (\$1,269).

Of the programs that will run on the entry model, a

Keyboard for 64

A NEW company, Silynn, has announced a full-size music keyboard for the Commodore 64 which will be priced under £150.

Called the Microsound 64, it is a four-octave keyboard which simply plugs into the cartridge port on the Commodore 64. Software, initially available only on disc, then converts keys depressed on the Microsound 64 into musical notes played through the tv loudspeaker.

The device also features two slider controls which operate a simple music synthesiser. Using these it is possible to alter not just the pitch of a note, but also its character.

Notes played on the unit can be stored in the memory of the computer, or saved out either to tape or disc, and recalled.

The software which accompanies the Microsound 64 — on disc — is the first of a series of programs to be produced by Silynn. Future packages will allow more complex musical effects, such as a sequencer using the different voices of the 64 and a hardware/software combination capable of digital sampling.

The Silynn Microsound 64 will be available in mid-December, priced at £125. Details from Autographics, 3a Reading Road, Henley-on-Thames.

proportion will only work in conjunction with a Basic extension cartridge which itself costs \$75. The so-called *Cassette Basic in Rom* on the entry model is not sufficient.

IBM itself suggests that the enhanced discette version of the PCjr will prove the more popular option. A configuration including the expanded model, tv connector, DOS 2.1 and cartridge Basic will cost over \$1,400. Of the five new software programs announced by IBM specifically for the PCjr, only one will work directly on the entry model, and two of the others require the Basic cartridge to work on the expanded model.

The PCjr. is only on sale at present in the US and Canada. No European launch date is yet available.

Magic Desk delayed

COMMODORE'S *Magic Desk* software for the Commodore 64 computer has been delayed again. The first package is not expected to go on sale in the UK until early next year.

When Apple first announced its Lisa machine in January this year, complete with 'mouse' graphics, Commodore was one of the first companies to announce software packages offering similar

Ted

Continued from page 1

would like to see a Spectrum-basher manufactured at Corby, which would be a cut-down version of the 64 without sprite graphics and advanced sound handling.

Acorn shoot-out

Continued from page 1

Sinclair had a product that would match up to the Acorn BBC machine.

"From Acorn's point of view the renewal is a formality — simply because of the relationship we have with the BBC. If there were going to be any problems we would know by now anyway."

● Since Acorn was awarded the BBC contract in April,

LUNAR JETMAN - For the 48K Sinclair ZX Spectrum
LUNAR JETMAN - The Ultimate Intergalactic G.A.S. (Graphic Arcade Simulation) Adventure Space Battle

LUNAR JETMAN - Arcade standard, 100% machine code, incredible sound effects, amazing smooth high resolution graphics, the totally new addictive concept and all those extra features you expect from the **ULTIMATE** games people
 Design - The **ULTIMATE PLAY THE GAME** design team

LUNAR JETMAN - 48K ZX Spectrum



COOKIE - 16/48K ZX Spectrum



PSSST - 19/48K ZX Spectrum



ATAC ATAC - 16/48K ZX Spectrum

ATAC ATAC - For the 48K Sinclair ZX Spectrum
ATAC ATAC - The super spooky 3D horror G.A.S. (Graphic Arcade Simulation) Adventure Game
ATAC ATAC - Arcade standard, 100% machine code, incredible sound effects, amazing smooth high resolution graphics, the totally new addictive concept and all those extra features you expect from the **ULTIMATE** games people.
 Design - The **ULTIMATE PLAY THE GAME** design team.

ATAC ATAC - 48K ZX Spectrum

Dealer enquiries welcome. Phone (0530) 411485

Available from W.H. SMITHS, BOOTS, WHITZ & LARKY'S, SPECTRUM CENTRES, other large computer stores and all good major software retailers.
 For a complete list of sports titles **ULTIMATE PLAY THE GAME** for the Spectrum visit our website, subject to availability.

£5.50 each including VAT, first class postage and packing within UK.

ULTIMATE PLAY THE GAME is a Trade name of Amby Computers & Games Ltd, The Green, Ashley Park South, Essex, SS4 5JU

NAME: _____
 ADDRESS: _____
 POST CODE: _____
 LUNAR JETMAN ATAC ATAC ATAC
 COOKIE PSSST TRAXX
 ATAC ATAC Expanded 16/48K
 (check price on PC card)
 Name: _____
 Address: _____
 Post Code: _____

LETTERS

Antescher rescue

Just a note to put in my claim for the title of 'First person to rescue all 10 victims from Antescher'.

I bought *3D Ant Attack* on 12 November and had completed it by 13 November. Rescuing each victim becomes harder as the game progresses, and as you are up against time as well as the guardian ants, each life saved is a great relief as well as a step nearer to your goal.

My score on completion was 33,106, as well as the gold medal I was presented with at the end of the game. I now throw out the challenge for someone to rescue the 10 prisoners in Antescher in a shorter time than it took me and with a higher score.

I hope Sandy White produces more software of this quality and originality.

Well, must go now as Ant Attack has just finished loading.

D Claypole
6 Hespion Road
Glington
Peterborough PE6 7JT

Strategy column

I read your magazine regularly and find it quite entertaining. I have therefore noted with interest the idea of an 'arcade corner'.

I would like to propose something different. A strategy/simulation column. I realise many disillusioned Neanderthal alien zappers turn to quests and gold for their entertainment — hence the success of Tony Bridge's page — but another medium from brain to computer is the 'you are in control' idea, ie, strategy/simulation.

The format of such a column would be much the same as Tony's corner — a review, comments and miscellaneous items. Although a subdivision of mind game, software houses do cater for us not-so-rare breed — DK Tronics, Lothlorien, Psion, Severn, CCS and Hewson, to name but a few. Please think about it.

D Mitchell
36 The Moorlands
Hanley Road

Malvern Wells
Worcestershire WR14 4PS
PS. Is New Releases a review or not? If not, then kindly refrain from making criticisms.

As with adventure games, there seems to be a growing interest in strategy and simulation games of all types. Flight simulation programs are particularly popular at the moment.

We would be very interested to hear the views of other strategist/simulators towards such a column.

As for New Releases, it is not intended as a review so much as a round-up of some of the software produced each week (the remainder you can find in our This Week column). But if a program has a feature which is particularly praise/blame-worthy, obviously we will mention it.

Commodore roasting

Can you explain why reviewers such as Andy Pennell need to abuse their position by making snide remarks about other computers whilst reviewing? I don't think that his remarks about the Commodore machines were complementary to a review on the Memotech micro.

So the Commodore needs add-ons, so do a lot of micros.

Fascinating patterns

Re Pete Gerrard's item on RCBM 64 (Vol 2, No 44, page 35). Herewith a small alteration, producing fascinating patterns.

Muck about with Z increments (line 70) and FNA (line

```
5 POKE53272, PEEK(53272)OR8
7 POKE53265, PEEK(53265)OR32
10 FORI=8192TO8192+7999: POKEI, 0: NEXT
12 FORI=1024TO2023: POKEI, 1: NEXT
13 Z=0.1
14 DEFFNA(X)=COS(X/Z)
15 FORX=0TO319
20 Y=INT(100+100*FNA(X/10))
25 C=INT(X/8): R=INT(Y/8): L=YAND7
30 BYTE=8192+R*320+8*C+L
40 B=7-(XAND7)
50 POKEBYTE, PEEK(BYTE)OR(2↑B)
55 IFY=<2THEN70
60 NEXT
70 Z=Z+0.3: GOTO15
```

You need about £60+ spent on the hallowed Spectrum to bring it anywhere near the Vic for keyboard and sound. Leave off, Mr P — the beloved ZX81 had to go through a roasting, now it looks as though it's the turn of Commodore.

One fed-up ZX81 and Vic owner.

I Boulton
7 Courtney Way
Kingswood
Bristol
BS15 2RX

Ego booster

I would like to reply to Craig Mitchell's 'Waste of space' letter (PCW 10-16 November).

My first point is that he himself wasted space by trying to boost his ego with his amazing high scores. 'Hey man, I've survived 5.3 centillion waves and saved the world's population after consuming a cruise missile, while playing Warfare.'

Point two is that it's *Tranz am* — note the weird shape after the n.

My last point is that if he understood what *Vetpac* and *Trantam* were, why did he bother to complain? If he understood, then everybody will be able to work it out.

PS. Please keep a few mistakes

14) for further fun. You've got to wait and wait.

N Leigh
7 The Handbridge
Fulwood
Preston PR2 4LE

in the clasifide pages and perhaps put sum in on purpos. Well done, Diane.

Lance Rock
(address withheld by request)

Competitive urge

Arcade games are certainly the most popular use of home computers, but is it really necessary to fill the valuable space of your letters page with claims of highest scores?

These claims seem particularly futile when you have also published letters describing bugs in some of the games which enable high scores to be achieved easily.

Recently, there was a letter describing the bug in *Jetpac* where, by standing on the middle platform on the fourth screen, the Jetman can, given time, achieve infinitely high scores without being shot. This week (10-16 November) you published a letter describing a *Jetpac* score of over a million which can be achieved by anyone capable of reaching the fourth screen.

The printer dump or photograph method of validating high scores is easily forged. I enclose a photograph (of poor quality) showing a high score of 999760 on *Jetpac*. In fact, I simply wrote a program to produce the screen display (about 10 minutes work) and could have inserted any value for the high score.



Perhaps the arcade fans could organise some events where the competitive urge could be satisfied. Hire a hall, set up a couple of Spectrums, load them with a popular program and let the alien zappers fight it out live. By charging an entry fee, the organisers could probably make a reasonable profit. This would leave the letters page free for some more thoughtful letters.

Simon Cross
Boland House
Guy's Hospital
London SE1 9RT

**If you have one of these
you'll need some of
these -**

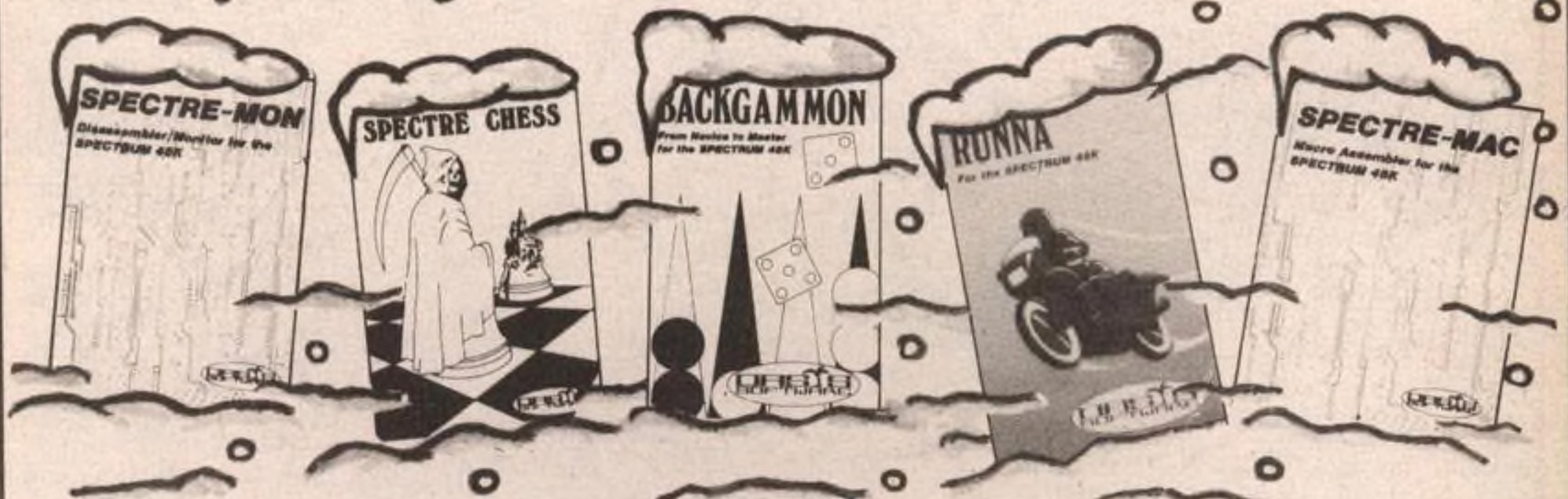
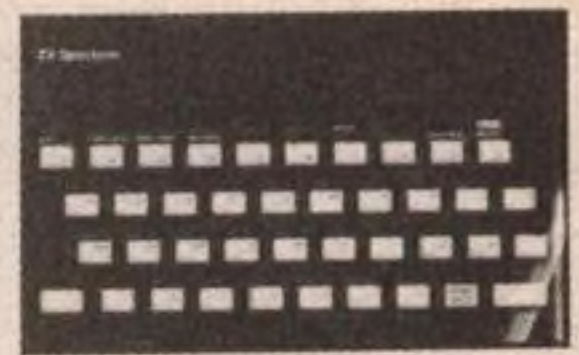

ATTENTION AUTHORS-COMING SOON



ARCADE FORTH is the most complete games language ever written.
 Complete implementation of Fig Forth extended to contain Sinclair's graphics and sound commands.
 For the newcomer, lines of BASIC can be executed from within Forth so no previous knowledge is required.
 A complete sprite language with more than forty commands. Sprites can be any size you choose and the only limit on the number is memory size.
 Programs written in ARCADE FORTH will run independantly of the compiler.
 Comprehensive manual and demonstration tape which covers the sprite commands one at a time.
 Faster and more flexible than any other program around, ARCADE FORTH is not a games generator it is a complete language.

SEND S.A.E. FOR DETAILS

IF YOUR DEALER DOESN'T STOCK THESE ITEMS LET US KNOW AND WE WILL CONTACT HIM !

Name _____ Address _____

	PRICE	QTY	TOTAL
SPECTRE-MAC	£9.95		
SPECTRE-MON	£9.95		
RUNNA	£5.95		
MILLIKILLA	£5.95		
INVADER CUBE	£5.95		
SPECTRE CHESS	£5.95		
BACKGAMMON	£5.95		
DRAUGHTS	£5.95		
DOMINOES	£5.95		
COMPENDIUM (Chess, Backgammon, Dominoes, Draughts.)	£14.95		
ARCADE FORTH <small>COMING SOON</small>	£14.95		

OVERALL TOTAL -

ALL PRICES INCLUDE VAT AND P&P
OASIS SOFTWARE,
 9a Alexandra Parade,
 Weston-super-Mare. Tel. 0934 515265



ACCESS ORDERS
 TAKEN BY PHONE
 24 HOURS A DAY

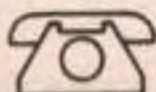

0934 515265

NEW RELEASES FOR CHRISTMAS FOR THE DRAGON 32



MIND GAMES COMPENDIUM

Chess, Dominoes, Backgammon,
Invader Cube and Othello. More
than £30 of software for just
£19.95



SPRINT

Basic Compiler
For the DRAGON 32

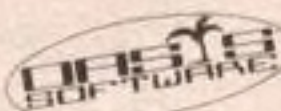

BASIC COMPILER

SPRINT
Convert your BASIC programs into pure smooth
6809 machine code with 'SPRINT' - the fastest
complete integer compiler on the market.
SPRINT will handle all the DRAGON'S sound and
graphics commands, FOR-NEXT loops, arrays
strings - the lot! In fact, so that you can compile
even bigger BASIC programs, SPRINT will compile
your program straight from tape!
If you think £14.95 sounds too cheap to believe,
go along to your local dealer and ask for a demo
before you buy.

ALL OASIS PRICES INCLUDE
VAT AND P&P AND EVERY
OASIS PRODUCT IS PROMPTLY
DESPATCHED AND INCLUDES
A LIFETIME GUARANTEE.

If your local dealer does not stock
these products then let us know his
address and we will contact him.

OASIS SOFTWARE,
9a Alexandra Parade,
Weston-super-Mare. Tel. 0934 515265

Please send me
SPRINT £14.95
MIND GAMES COMPENDIUM £19.95
SINGLE GAME CASSETTE £ 9.95

I enclose Cheque/P.O. for £

NAME

ADDRESS



ACCESS ORDERS
TAKEN BY PHONE
24 HOURS A DAY



0934 515265

Amoeba's Playtime

A new game for 48K Spectrum by Terry Wiley

Down at the Microscopic Zoo, Fang the Killer Amoeba is happily squishing around the deserted Bacteria Compound. But playtime is over, and it's time to put the bacteria back.

Fang is annoyed at this interruption, and will eat the bacteria if they are left unprotected, so you must attempt to enclose bits of the compound with amoeba-proof fences, where the bacteria can be safely re-introduced.

The fence-layer (a little blue block at the bottom of the screen) can be moved around the edges of existing fences with the cursor keys 5 to 8, and can draw new fences by also pressing CAPS SHIFT. However, be warned that uncompleted (red) fences are vulnerable to Fang, and if he hits one you become his next meal and the game will end.

To safely complete a fence, join it to the compound wall or to another completed region, and the empty pen will fill with bacteria. One point is obtained for every bacterium introduced, and if you manage to introduce more than 6,000 bacteria, Fang will give up and go back to his cage. Each bacterium above this threshold scores 2 points; note that you need 100 extra bacteria each screen to subdue Fang.

To enter the program, do the following:

- (1) Produce, as line one, a REM followed by 230 'x's
- (2) Edit the REM line number to 2 to make another REM-ful of 'x's
- (3) Type in this machine code loader:
3 INPUT A,B: FOR N = A TO B: INPUT;" ";z:

POKE N,Z: PRINT N,Z: NEXT N

- (4) Run the program twice with the following INPUT:
 - (i) 23762, 23987, then the code in fig. 1
 - (ii) 24000, 24203, then fig. 2

Save the program if you wish to test the code; *Usr 24000* should turn the screen black; *Plot 100,0 : Draw 255,0 : Plot 120,0 : Draw 255,0 : Randomize 28270 : Let Z = Usr 23762* should produce a band of bacteria (dots).

There are two other routines, *Usr 24024* and *Usr 23954*, which require numerous Pokes and don't have a fixed effect (one moves Fang, the other creeps around boundaries looking for a specified point) which are best tested by the program itself, so check the code carefully and Save the whole program (lines 3 to 4010 from the listing, plus the two REM's) before running it. ■

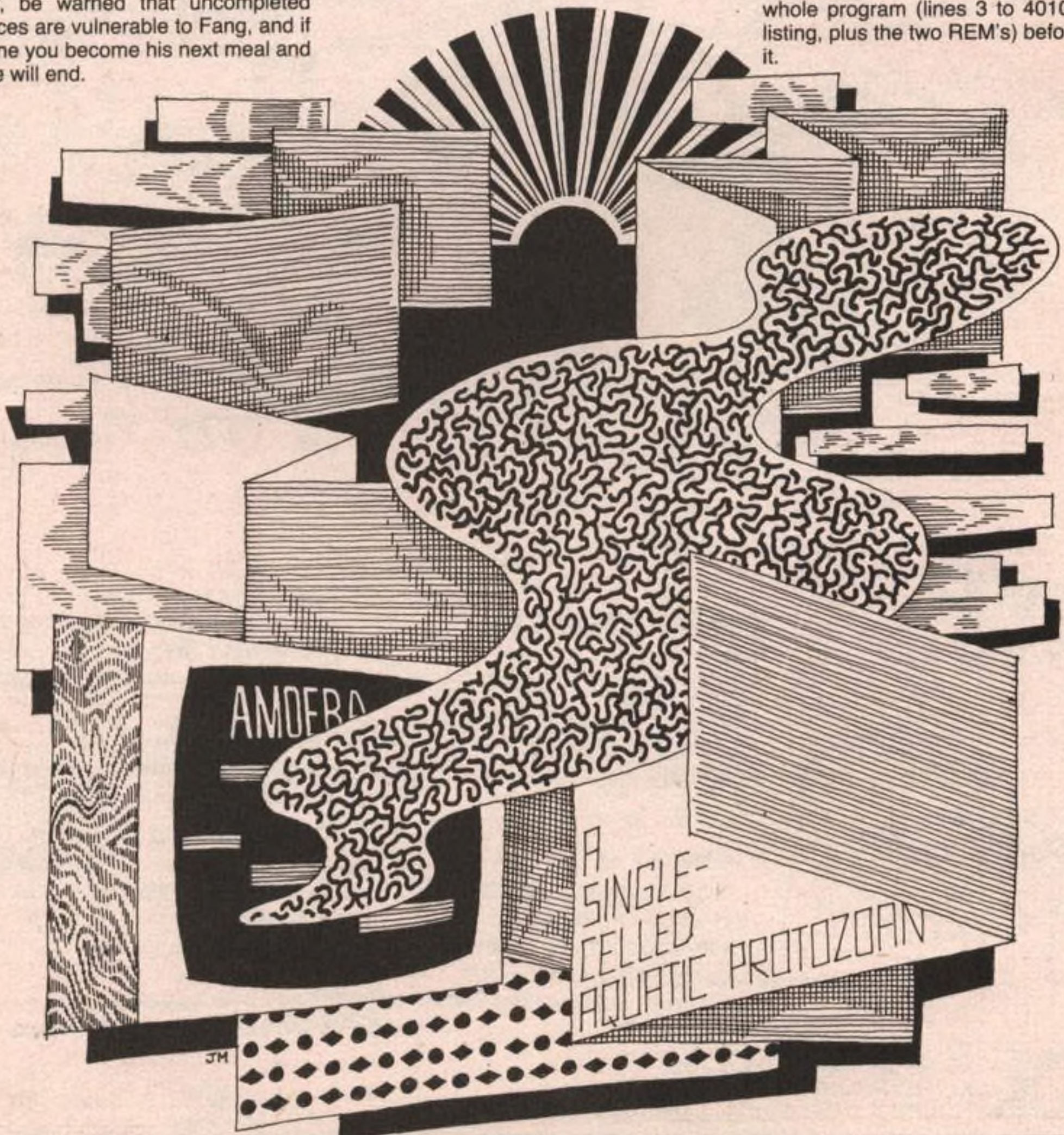

WANTED

PROGRAMS

Top Quality Machine Code Games Programs
for All The Home Micros, including:—

ZX SPECTRUM
COMMODORE 64
ACORN ELECTRON
BBC
DRAGON
VIC 20
ORIC
etc



We also require freelance M/C Programmers.

We distribute throughout the U.K.,
U.S.A. and Europe.

Write in confidence to:
THE SOFTWARE DEVELOPMENT MANAGER

NOW!

THOR (Computer Software) Co. Ltd.

Erskine Industrial Estate
Liverpool
L6 1AP

OR TELEPHONE:
051 - 256 7666

HUGE



REWARD

Budding superstars

Graham Taylor looks at the growing links between electronic keyboards and micros

What costs between £40 and £500, has a memory, is programmable, and can be used with add-ons like light pens? It's a Casio keyboard.

Just as microcomputers have moved out of the specialist shops and now flourish in toy stores, book shops and supermarkets, so electronic keyboards have moved out from the specialist music shops.

A Casio electronic keyboard is a bit like an organ, but is capable of very unorgan-like sounds. It's a bit like a synthesizer, but is very easy to program. In some respects, it's even a bit like a computer...

Casio Electronics is a Japanese company whose pre-tax profits rose by 13.4 percent to around £20m (Y7bn) in the half year ending in September. Although Casio is involved in a number of electrical products, all of which have grown in sales, the really startling growth is found in their office computers and their electronic musical instruments — up by an enormous 50 per cent.

Britain has taken the Casio keyboard to its heart; the basic model, the VL-1, has sold nearly half a million since its release in May 1981.

Dave Caulfield is the National Sales Manager for Casiotone UK. Even he is surprised by their success: "We've tried to do an analysis of our market, but it's really impossible to come to any specific conclusions — there seems to be almost no type of consumer who couldn't be a prospective purchaser.

"Britain has always been full of weekend musicians — people who play for their own amusement at the weekend — no musical instrument manufacturers could manage on the sales to the big name groups, but Casio has gone beyond that."

As with computers, the technology is getting relatively cheaper and much more widely available. "With a four-track cassette machine and a mid-range Casio, you have about as much equipment in your home as the Beatles had for their early records," explained Dave.

The instruments are, inevitably, the result of microchip technology. The internal workings, complete with sound and rhythm chips, memory, and input/output ports would be familiar territory to computer buffs.

Just as computers have an international standard for connecting one to the other — RS232 — so the latest generation of electronic keyboards have a similar standard interface called MIDI, or musical instrument digital interface. This enables one keyboard to be played from another set to different sound styles; eg, brass on one and strings on another. "You could also slightly de-tune one of the keyboards to get a very full, spacey sound," explained Dave.

To complement the new Casio keyboards, the company will be selling interfaces for the best selling micros — this will almost certainly include Commodore, Acorn and Sinclair.

Surprisingly, perhaps, Dave does not see the computer adding much to the quality and range of sounds available from the micro: "If that were the only point of the interface, why bother? Even the VL-1 has more sound facilities than most of the micros — certainly for practical musical purposes."

The real point of the computer link Dave sees as educational: "As much as anything else, we're trying to make it easy to learn music and it's important to give people visual references — it's something we've tried to do using the LEDs that light up each note as it's played, but obviously with a tv screen we could do much better."

To this end, Casio are starting to look at software houses as potential independent suppliers of educational material. "I see us consulting with a software house in terms of technical information, but it's the visual display that will be really important — there are so many different ways the two things could be tied together."

Whatever the future of the keyboard/micro linkup, one thing seems clear from even a cursory glance at the latest machines — some fundamental computing concepts are being incorporated. Perhaps the most interesting of these is the idea of Rom and Ram cartridges.

Two machines, the MT 800 and the PT 50, include cartridge slots very much like those on computers.



Rom cartridges contain groups of popular pieces of music which the Casio will play automatically. Budding superstars and egomaniacs everywhere can even connect a microphone to the machine and mix in their voice to sing along with the music.

The PT 50 can also accept Ram cartridges, which is perhaps the most important new development. The Ram cartridges are used, rather like a tape recorder with computers, to store your own creations for retrieval at a later stage.

The idea of Ram is likely to be extended further, using it to store actual sound types for example. "If you wanted, you could have no sounds built into the keyboards at all — just cartridges containing various sound building blocks whose parameters you can change using the instrument."

A similar idea is already found in some of the Casios including the VL-1 using the ADSR function which stands for attack, decay, sustain, release. This gives the main features of the preset sounds a numerical code consisting of feet, envelope and modulation. These can then be mixed in any combination to give a wide range of sounds different to, but derived from, the presets.

In principle, this idea could be extended to give virtually limitless ranges of sounds. The Casio 1000P, for example, is capable of most things an expensive synthesizer can produce, merely by manipulating 10 presets in exactly this way.

Casio has plenty of competitors, including Seiko and the mighty Yamaha, but Dave is confident. "Casio won't produce anything unless we are sure there is a big market for it. We've been aware of the computer market for a long time, but basically we've made a decision not to get involved either with the keyboards or by, say, issuing our own home computer."

Next year will see the demise of many well-known computer companies, predicts Dave. "It's a good job we've kept on the sidelines. Look at the big names who are in trouble — the shakeout has already started."

"By the middle of next year, we'll have keyboards with interfaces built in and we'll cover the major micros by providing appropriate connectors. But, with the Casio keyboard I think we've discovered a genuine consumer product — something that appeals to all sorts of people for all sorts of reasons. I sometimes wonder if that's really true of home computers." ■

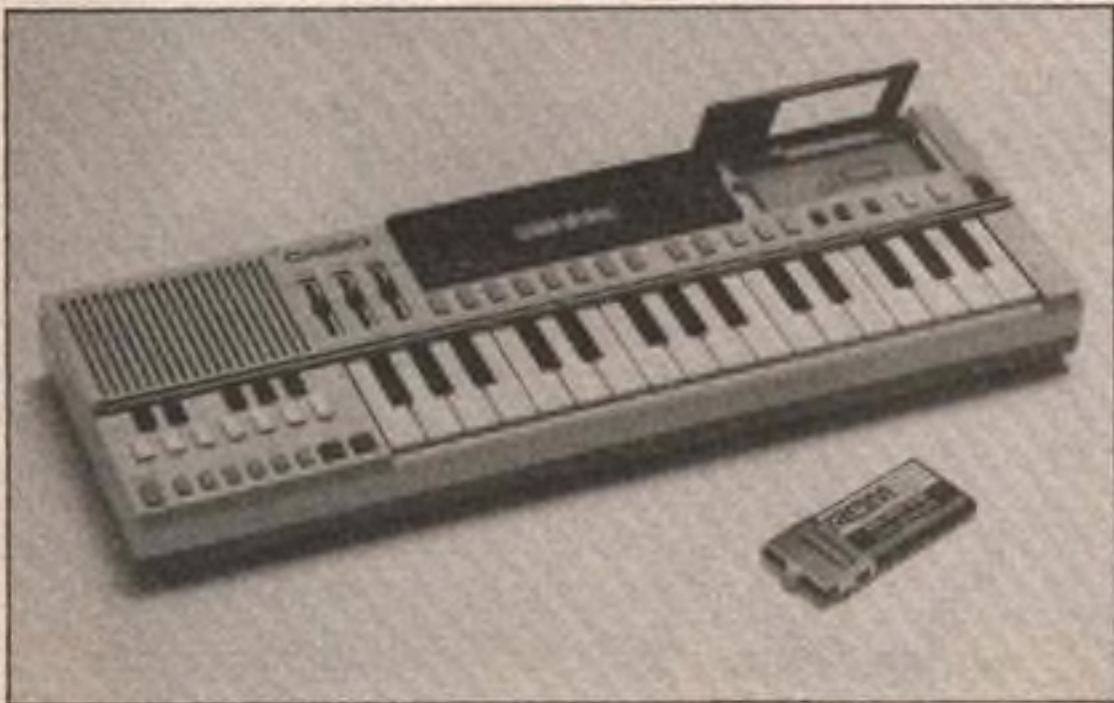

WALF

48K SPECTRUM

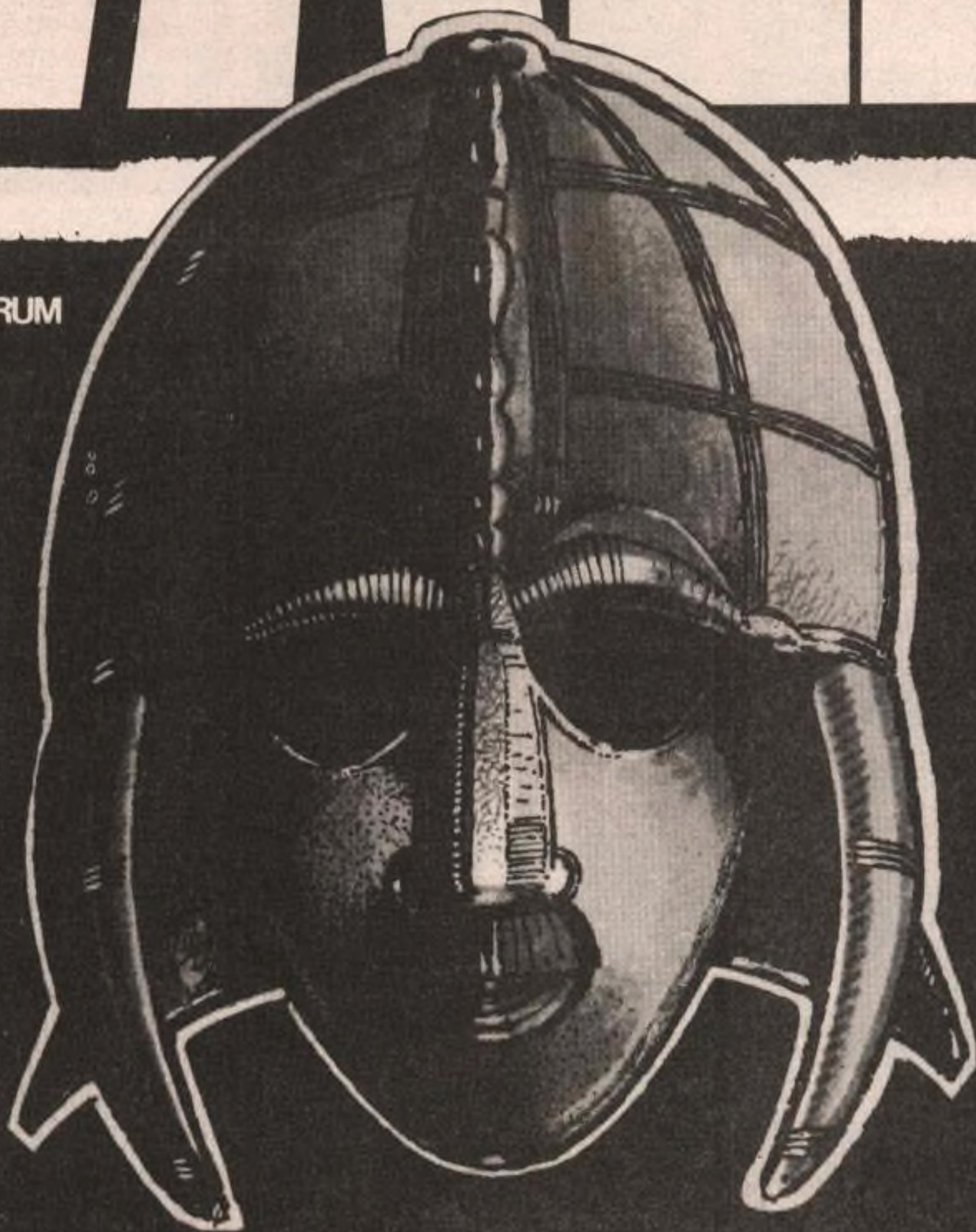

VALHALLA



VALHALLA is supplied on a 48K Spectrum program cassette, with VALHALLA player manual and presentation box. As VALHALLA uses the full 48K RAM, microdrives and full-size printers are not supported. ZX printer optional.

VALHALLA is normally available from stock, and orders are despatched by return. If, for any reason we are unable to fulfil your order within 14 days of receipt, we will notify you.

VALHALLA cassettes carry an unconditional lifetime replacement guarantee. **TO ORDER:** (UK Orders Only) Simply complete the coupon, and FREEPOST with your cheque/P.O. made payable to LEGEND (UK Mail Order).

Credit Card Orders: By phone 9-5.30 Mon to Fri, stating name and address, Card No, and Item(s) required.

RETAILERS: Please contact your regular distributor or LEGEND (Trade Distribution) at the address below

LEGEND (UK Mail Order) FREEPOST
1 Milton Road, Cambridge CB4 1UY
(0223) 312453

MOVISOFT OPERATING SYSTEM UNDER LICENCE

Post to:- LEGEND (UK Mail Order) FREEPOST
1 Milton Road, Cambridge CB4 1UY

Please send me.....Copy/copies of
VALHALLA for the 48K Spectrum.

I enclose cheque/P.O. for £.....
(£14.95 each incl. VAT and P&P).



Or I wish to pay by Access/Barclaycard/Visa
Card No.....

Please print name and address

Name.....

Address.....

Credit Card holder's signature.....

POP.W.47

The expanding Dragon

Keith and Steven Brain take a look at the range of enhancements now on the market for the Dragon

No home micro is initially capable of everything the user might want to do with it and therefore it is usual for a range of enhancements to come on to the market from independent suppliers. The Dragon is well supported by the independents who offer a wide range of products on cassette, cartridge, and now disc.

These offer a wide range of facilities, but it is often difficult to compare their capabilities with the advertising claims. This review takes a look at many of the products now available and evaluates the potential benefits to the user.

One of the main criticisms of the Dragon centres on the text display. Many people feel that 32 columns is not enough, and that true lower case characters are really essential. There are several ways of remedying this problem by generating high-resolution characters within a Basic program, but several companies are now offering machine code programs providing text on the hi-res screen. Below are details of four of these which differ somewhat in their capabilities and price; two of these are "Hybrid" products offering "high-res text" and "tool kit" functions at the same time.

Scribe (Premier Software) is available on tape and the Delta disc system. It produces upper and lower case on a 42*24 display in *Pmode 4* only. The size matrix was apparently selected as the largest which can be guaranteed to be clearly legible on most domestic tv's and it

numbers, although this procedure is clearly explained and instructions are given for saving your redefined character set.

Scribe is compatible with the other Premier utilities and will often be used in conjunction with them. At £13.95 on cassette or £14.95 on disc, *Scribe* offers reasonable value for money, if you only want to produce a relatively straightforward 'true text' display.

Rainbow-Writer (Microdeal) was originally written for the Tandy CoCo by Rainbow Connection Software and it is the only commercial software we have seen so far on a Dragon Disc, although apparently Microdeal plan to sell discs configured for the Premier/Cumana Delta system.

There are two versions of *Rainbow-Writer* provided, which give 32/42 characters a line or 50/64 characters a line. In each case you can alter the distance between each character by specifying a low-density (32 or 50) or a high-density (42 or 64) mode. You can also enlarge characters up to a massive 16*8 which is good for titles and educational purposes.

The character sets can be redefined and if you want to save memory you can load in only a partial set. The program locates itself at the top of memory and it therefore does not interfere with many other enhancements. You can produce legible text in any *Pmode* as well as different size, width and colour characters,

subscripts, superscripts, inverse video and underlining.

You can also produce artefacted colours in *Pmode 4*, protect parts of the screen from scrolling, and mix the facilities on the screen at the same time. At any point you can call up a *Help* screen which tells you the current settings of the program. A demonstration program showing the

advanced features of *Rainbow-Writer* and a good on-screen character generator are included.

John Symes says that the Dragon distributor in Greece is giving away a copy of *Rainbow-Writer* with the Greek character set with every machine! The only real winge is that the display commands must be called by Escape sequences, rather than new Basic commands, so that you have to type *Print CHR\$(27) "★★★"* each time (where ★★★ is one of many commands). Of course you could predefine the

command sequences you will be using frequently as strings.

This is the most flexible of the high-resolution text enhancements and even though the price is around £20, it is good value if you are going to use the versatile facilities. It is interesting to note that encouragement and a 'limited licence' is given to the incorporation of the program into commercial software, rather than the usual dire (and ineffective!) threats.

Edit+ (including *Hi-res*) (Compusense) is a cartridge so it uses very little of the Dragon memory, but of course it effectively blocks the expansion port so that you cannot add anything else. Two instruction booklets are included, one for *Hi-res* and one for *Edit+*, and since *Hi-res* is also sold separately we will consider the facilities of that first.

The program produces a 51*24 character display, but only operates in *Pmode 4*, which becomes the default mode whenever you use *Print* or a prompt appears. There are four *Print* commands: *Print* uses the whole 51*24 matrix, but *Print @* uses a 32*16 window so that it is compatible with the normal Dragon display and you can test normal-mode programs. *Print 1* is similar to the standard *Print @*, but works on the 51*24 matrix, and *Print %* prints 'sprites' which are specified by X and Y coordinates.

These sprites are actually characters which are put on the screen with exclusive-OR logic, and the sprite mode is rather irritating to use as the prompts, cursor, and *Print* command become distorted. Nine character sets are included (although many of the 'different' characters are the same) and characters can be redefined, although this must be done by calculating binary numbers and the definition must be saved as a separate program.

The *Cls* command is extended to provide a number of functions and control codes are also used to provide some extra features. Auto-repeat is included, but there is a very long delay before it is activated.

The *Edit+* "full screen editor and programmers tool kit" is only activated when you type *Edit*. It displays the program on the 51*24 screen and has editing features of the type usually found on word processors. Reading programs formatted to 51 characters was rather difficult and the screen refresh was very slow so that it took a long time to work through a program.

The editing and "tool kit" facilities were not very impressive especially when compared to the competition, and at £25 for *Hi-res* and £34 for *Hi-res* with *Edit+*, rather over-priced. The cartridge approach is not the most logical way to provide these facilities.

Picture Writer (Rampage) is more than just a text on hi-res screen program as it includes some useful extensions to Basic. It is supplied on a tape which auto-starts, and it sits at the bottom of memory. The

```
THIS IS SCRIBE IN UPPER CASE
THIS IS SCRIBE IN UPPER and lower case
PRINT CHR$(1)

THIS IS SCRIBE under lined
PRINT CHR$(1);CHR$(2)

THIS IS SCRIBE
```

was certainly very clear on the three sets tried.

Automatic underlining and inverse characters are available using *Print chr\$(n)* and the *Print @* command uses the 42*24 grid. Another extremely useful command is *Put @ X,Y,n* which allows you to place a character anywhere on the screen to within one screen point, allowing you to produce subscripts, superscripts and 'sprites'. The *Print 1* command allows you to redefine characters, but you have to calculate these as a series of binary



display is only 32*16 but it has true upper and lower case, a full screen cursor, commands to program the cursor through *Print* statements, and it is a great improvement over the standard display.

A major difference to the other text on high-res programs is that you have separate control over text and graphics where these are mixed. There are three types of screen clear. *Pcls* or *Cls* just clears any graphics on the screen and leaves the text, *Clst* clears the text and leaves the graphics, and *Cls* clears both.

You can specify scroll protected areas or *Freeze* the screen completely, and scroll the text over static graphics. Characters can be redefined using either binary codes or a proper screen-based character generator which is activated by the *Char* command, and *Csavec* saves character sets without the need to remember addresses, and allows you to save only parts of the character set.

If you type *Graf Off* you go back to the normal Dragon display but the additional Basic commands are still available, including the full screen cursor. The keyboard is redefined so that the graphic characters can be accessed directly from the keyboard, and use abbreviated keyword entry. You can set the keyboard back to normal with *Key Off* and auto-repeat and a bell are included which can be turned on and off by *Rep On/Off* and *Bell On/Off*.

An *Old* command is provided which will normally resurrect a program which was accidentally *Newed*, and you can switch between *Fast* and *Slow* mode.

This program offers a useful extension to the facilities of the Dragon and at £10 it is excellent value for money.

Although the Basic commands for handling sound in the Microsoft Extended Colour Basic used on the Dragon are very easy to use, only one sound channel is available which is rather limiting, and the

'speech' produced by *Computavoice* and programs like *Talking Android Attack* is pretty unintelligible.

On the other hand *The Dragon Composer* program (Microdeal/Speech Systems) solves the music problem as it gives you four sound channels, each one with up to seven octaves. You enter tunes in a format which has some resemblance to the *Play* command, but in *Data* statements which are placed at the end of part of the composer program. For example:

```
3010 DATA D5G4D4B4Q
```

means:

```
Play note D in octave 5 in channel one
G         4         two
D         4         three
B         4         four
```

(All the notes being quavers (Q))

Fifteen lengths from a whole note to a 1/32 note are allowed, sharps and flats are available, and the tempo and key can be changed. Comprehensive editing and saving facilities are included and when you have entered your tune you can compile it into a self-contained machine code subroutine with the *Complate Source* command.

You can *Play* this *Music* directly, but an important feature of *Composer* is that you can also use this compiled routine to add first-class sound to any other program. Although the processor is totally dedicated to producing the sound you can put the command *Basic* into the *Data* to return control to Basic during a tune, so that you can arrange to interrupt it if necessary.

This program completely transforms the sound output of the Dragon and even at £15 it is good value for money and includes very clear instructions.

You are never going to get real speech without extra hardware such as that used in the *Speech Synthesis Module* (JCB Microsystems) which is a cartridge giving very clear speech with only a slight transatlantic accent. It uses a General Instrument SP0256 Speech Processor and a custom ROM containing predefined words.

A clear manual is provided which explains in detail everything you could possibly want to know about the system. The simplest method is to use the *Say* command which allows you to easily produce any of the predefined words. For example, a polite computer might start by saying to the user:

```
10 SAY "HELLO" 3, GOOD, 3, MORNING, 5, 1, 2, AM
   ,4, YOUR, 4, DRAGON, 4, COMPUTER, 5"
20 SAY "PLEASE, 4, TYPE, 4, YOUR, 4, INSTRUCTION, 4"
```

The *Say#* commands deals with numbers and is very impressive when you give it values like 123456789 which immediately comes out as "one hundred and twenty three million, four hundred and fifty six thousand, seven hundred and eighty nine" and if you add a zero to the end it instantly converts it to "1.23456789 exponent plus nine". Equations like *Say.120 2/3* are allowed and it automatically rounds up after eight places.

In addition you can use the 64 allophones (individual speech sounds) to create any word which is then called by the *Speak* command. Using allophones takes some practice and experimentation to get the desired result but it extends the range of the module to an infinite vocabulary. For example, you might like to add the word "master" to that request for instructions:

```
30 SPEAK "MM,AR,SS,TT2,ER1,4"
```

The *Add* command allows you to mix *Say* and *Speak* to form likes like:

```
40 ADD, SAY "BY, 4, DRAGON, 4; SAY# 32; SAY"
   GAMES, 1"; SPEAK "SS, 4, MM, AR, SS, TT2,
   ER1, 4"; SAY "o, 3, K, 4"
```

You can also *Say* or *Speak* strings and *Say#* variables. As these commands do not halt the program you can mix speech and graphics very effectively and while the computer is actually speaking you can do almost anything else with it, except create sound, or use the joysticks or cassette interface.

It is obviously a great asset in education, and in producing really "user-friendly" programs. £37.95 is a fair price for this useful add-on.

Firm	Program	Cost
Compusense Ltd PO Box 169 286D Green Lanes London N13 5XA	<i>Edit+</i>	£34 (+ Hi-res)
JCB Microsystems 29 Southbourne Road Bournemouth BH6 5AE	<i>Speech Synthesis Module</i>	£37.95
Microdeal 41 Truro Road St Austell Cornwall PL25 5JE	<i>Rainbow Writer</i> <i>Dragon composer</i>	£20 £15
Premier 208 Croydon Road Anerly London SE20 7YX	<i>Scribe</i>	£13.95
Rampage 32 Birchwood Drive Wilmington Dartford Kent PA2 7NE	<i>Picture Writer</i>	£10

End of the line

W R Masefield explains how to calculate the frequency response of 4-terminal networks

This program for the ZX Spectrum was developed to be a time-saving aid in the calculation of voltage transfer ratios and input and output impedances of simple 4-terminal electrical networks containing resistance, inductance and capacitance. It is not an exhaustive treatment and is applicable only to networks which can be reduced to a sequence of series and shunt sections of the general form shown in Figure 1.

The method of calculation is by simple A-matrices. For those not familiar with matrix algebra, the following brief account may be of help — for a fuller treatment, you should consult a textbook.

Briefly, any 4-terminal network having passive components — resistance (R), inductance (L) and Capacitance (C) — can be represented in the form of a 2 × 2 matrix (Figure 2). There are several ways in which the matrix can be made up. For our purposes, the one relating input vol-

tage and current to output voltage and current (the so-called A-matrix), is the one to use (Figure 3). This has the advantage that, for a sequence of sections of a network, the overall matrix is the product of the individual section matrices taken in sequential order:

$$(A) = (A_1) \times (A_2) \times (A_3) \dots$$

Matrix multiplication follows a special rule, as shown in Figure 4.

Any series of shunt section can be represented by a simple matrix of the form shown in Figure 5. These matrices are then multiplied together to give the overall matrix. Once the overall matrix has been found, it is a simple matter to derive the frequency response of the complete network, since the voltage transfer ratio is given by:

$$\frac{V_{OUT}}{V_{IN}} = \frac{1}{a_{11}} \text{ with output open-circuit,}$$

and the input and output impedances by:

$$Z_{IN} = \frac{a_{11}}{a_{21}} \text{ with output open-circuit,}$$

and

$$Z_{OUT} = \frac{a_{22}}{a_{21}} \text{ with input open-circuit.}$$

This program is easily adapted for other machines, as it makes no use of artful dodges. On Run, the user is asked to input the number of sections, whether they are series or shunt and all the components of the sections, in turn. Where a particular component is absent a zero is entered. For example, if a section contains resistance only, then zero is entered for inductance and capacitance. The computer recognises the zero to mean "no inductance" or "no capacitance", *not* as a short-circuit or open-circuit condition.

After putting in all the components, the next prompt is for frequency. As written, the maximum frequency is 9,999,999Hz (almost 10MHz) — anything larger will exceed the print format.

The program takes a few seconds to work out the answers, depending on how many sections have to be multiplied together. After display, the next frequency can be entered and so the response is gradually built up. As an example, Figure 6 shows a simple network and the printout obtained for it.

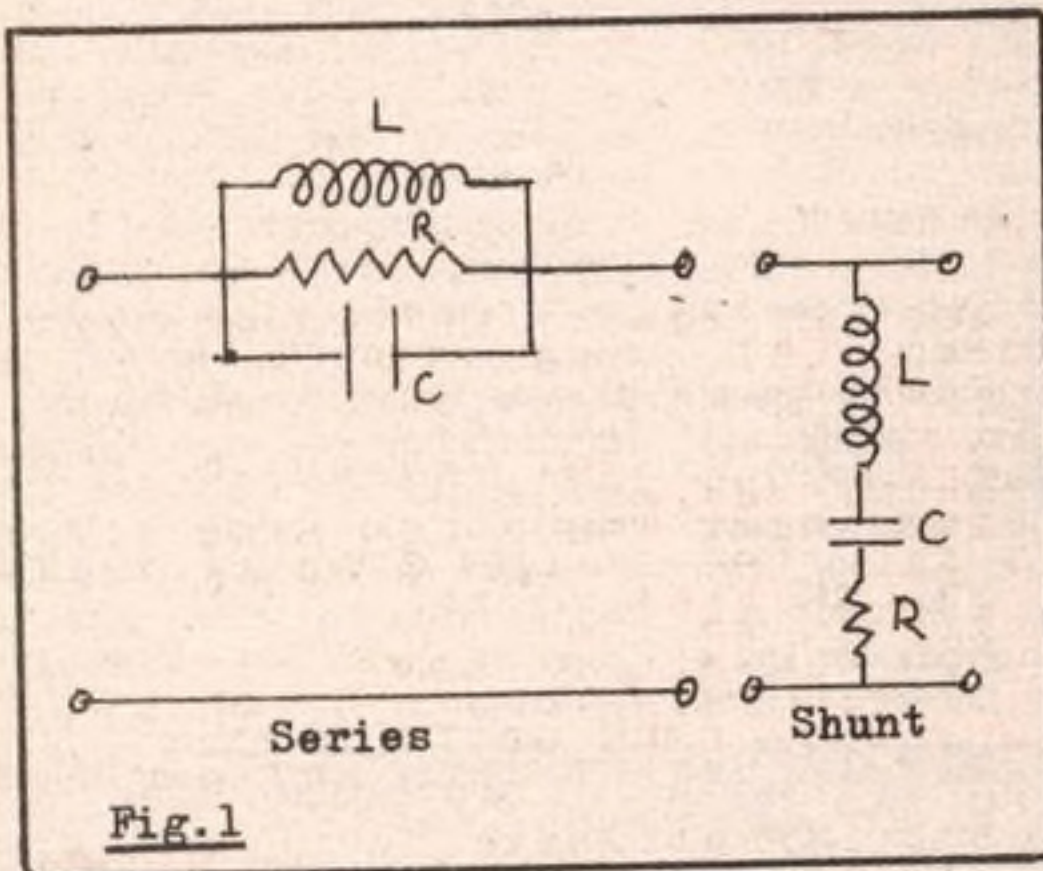

Fig.1

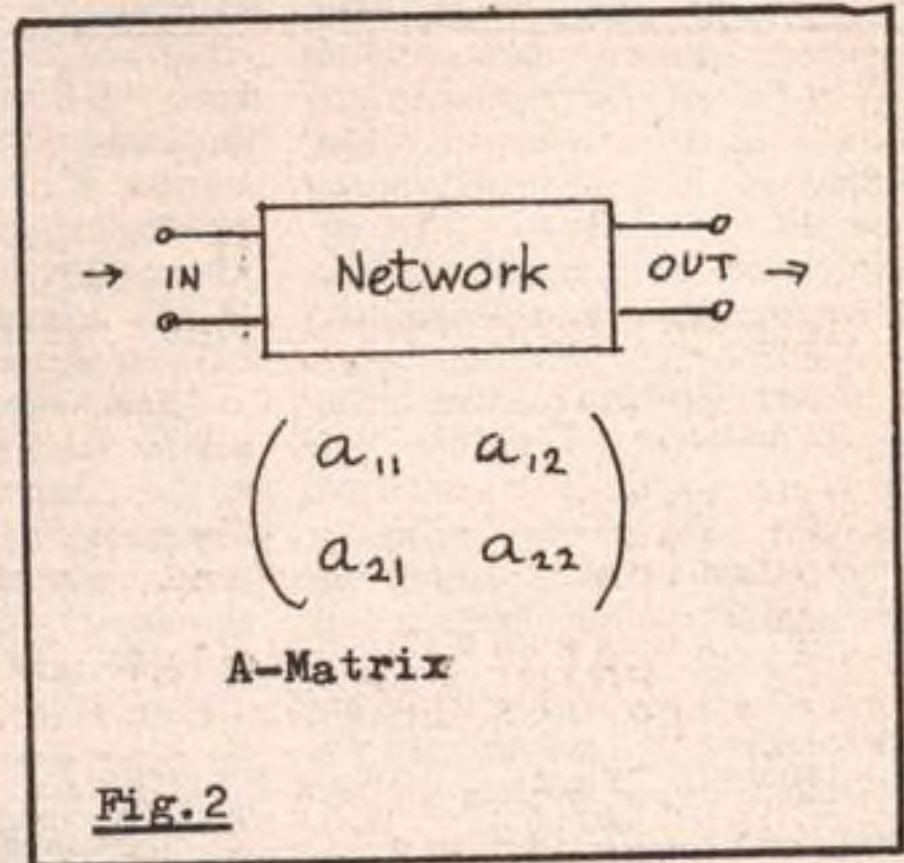

Fig.2

$$\begin{pmatrix} v_{IN} \\ i_{IN} \end{pmatrix} = \begin{pmatrix} a_{11} & a_{12} \\ a_{21} & a_{22} \end{pmatrix} \begin{pmatrix} v_{OUT} \\ i_{OUT} \end{pmatrix}$$

A-Matrix Equation

Fig.3

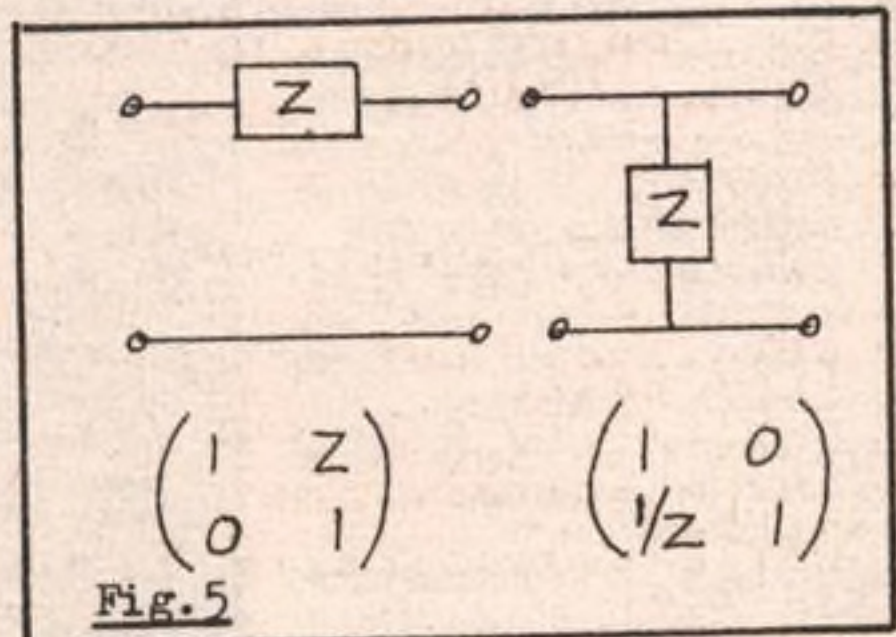
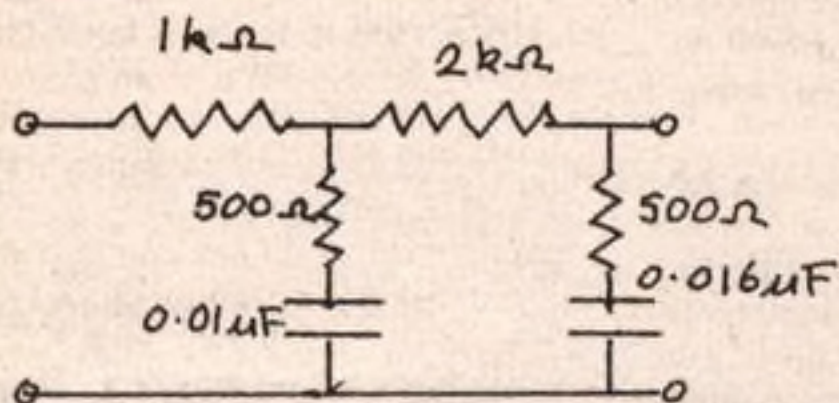

Fig.5

$$\begin{pmatrix} a_{11} & a_{12} \\ a_{21} & a_{22} \end{pmatrix} \begin{pmatrix} b_{11} & b_{12} \\ b_{21} & b_{22} \end{pmatrix} = \begin{pmatrix} a_{11}b_{11} + a_{12}b_{21} & a_{11}b_{12} + a_{12}b_{22} \\ a_{21}b_{11} + a_{22}b_{21} & a_{21}b_{12} + a_{22}b_{22} \end{pmatrix}$$

Matrix Multiplication

Fig. 4



4-Section Network and Frequency Response

FREQUENCY RESPONSE OF 4-SECTION NETWORK

Freq. (Hz)	Vo/V-in (VdB)	Z-in (Ohms)	Z-out (Ohms)
50	-0.2	124182	122722
100	-0.3	62966	61508
200	-0.6	32354	30899
500	-1.5	13975	12531
1000	-2.8	7830	6402
2000	-5	4727	3330
5000	-9.5	2795	1473
10000	-14.6	2006	854
20000	-19.4	1598	569

Fig. 6

```

5 REM NETWORK FREQUENCY RESPON
NSE
5 REM © W.R.Masefield 1983
10 CLEAR : INPUT "No. of Secti
ons?";n
20 DIM b(3*n): LET k=1
30 LET s$="": FOR j=1 TO n: IN
PUT ("Section ";j;" Series or Sh
unt?");a$
40 LET s$=s$+a$(2 TO 2)
50 CLS : PRINT FLASH 1;AT 13,0
;"Enter zero for any R, L or C n
ot present"
60 INPUT "Resistance? (Ohms)";
b(k),"Inductance? (Henries)";b(k+
1),"Capacitance? (Farads)";b(k+2)
70 LET k=k+3: NEXT j
100 CLS : PRINT "FREQUENCY RESP
ONSE OF": PRINT TAB 6;N;"-SECTIO
N NETWORK": PRINT
110 PRINT "  Freq.  Vo/V-in  Z
-in  Z-out"
120 PRINT "  (Hz)      (VdB)  (O
hms)  (Ohms)"
130 INPUT "Frequency? (Hz)";f
140 LET k=1: LET j=1: GO SUB 30
0
150 LET c1=d1: LET c2=d2: LET c
3=d3: LET c4=d4
160 FOR i=1 TO n-1: LET k=k+3:
LET j=j+1: GO SUB 300
170 LET e1=c1*d1+c2*d3: LET e2=
c1*d2+c2*d4
180 LET e3=c3*d1+c4*d3: LET e4=
c3*d2+c4*d4

```

```

190 LET c1=e1: LET c2=e2: LET c
3=e3: LET c4=e4: NEXT i
200 LET v=20*LN (1/e1)/LN 10: L
ET v=INT (v/.1+.5)*.1
210 LET zi=INT (e1/e3+.5): LET
zo=INT (e4/e3+.5)
220 PRINT TAB 8-LEN STR$ f;f;TA
B 11;v;TAB 24-LEN STR$ zi;zi;TAB
32-LEN STR$ zo;zo
230 GO TO 130
300 REM Matrix SBR'
310 IF s$(j TO j)="h" OR s$(j T
O j)="H" THEN GO TO 390
320 IF b(k)=0 THEN LET g=0: GO
TO 340
330 LET g=1/b(k)
340 IF b(k+1)=0 THEN LET bl=0:
GO TO 350
350 LET bl=1/(2*PI*f*b(k+1))
360 LET bc=b(k+2)*2*PI*f: LET z
=1/SQR (g*g+ABS ((bl-bc)*(bl-bc)
))
370 LET d1=1: LET d2=z: LET d3=
0: LET d4=1
380 RETURN
390 LET r=b(k): LET xl=b(k+1)*2
*PI*f
400 IF b(k+2)=0 THEN LET xc=0:
GO TO 420
410 LET xc=1/(2*PI*f*b(k+2))
420 LET y=1/SQR (r*r+ABS ((xl-x
c)*(xl-xc)))
430 LET d1=1: LET d2=0: LET d3=
y: LET d4=1
440 RETURN

```

Fig. 7

Rudely interrupted

Alan Went unmasks some of the secrets hidden in the Spectrum interrupts

The Z80 processor used in the Spectrum has a set of connections and instructions that allow the normal running of a program to be interrupted, and a subroutine called and Run, before returning to the main routine.

Two types of interrupt are allowed on the Z80. Firstly, the non maskable interrupt. When the signal on this pin is activated, the processor will always jump to location 66H and Run the routine there. This is not used on the Spectrum.

Secondly, the maskable interrupt. A signal on this pin will cause one of three courses of action to occur, depending on the interrupt mode selected. In mode 1, the cpu executes an instruction provided by an external device. This mode is not used on the Spectrum.

Mode 2 is the normal Spectrum mode. When an interrupt occurs, the cpu stores its current program address and jumps to location 38H (56 dec) and continues from there. The Spectrum routine here increments the Frames (Timer) variable, then reads the keyboard. The hardware is arranged such that these interrupts occur every 20mS (50 times per sec).

When the interrupt occurs, the cpu forms an address using the contents of the I register as the high part of the address and the value placed on the data bus by the interrupting device as the lower part of the address. The contents of the address so formed are used as the address to jump to. Thus, a table of subroutine start addresses can be held in memory, with the interrupting device combining with the I register to look up the appropriate address for that device. If no data byte is placed on the data bus, the cpu will read FFH (255 dec) and thus look at the address $I * 256 + 255$ (and + 1 as a 16 bit address is required), and jump to the address stored there.

When the Spectrum is running a Basic program, and during editing, the interrupts are enabled, and only disabled during time-critical routines such as *Save/Load* or when using the beeper. Interrupt mode 1 is selected at all times, and the I register contains 3FH (63 dec).

Listing 1 On/Off Routines. Assembler

Addr.	Code. Label	Inst.
FE56	3E09 ON	LD A,9
FE58	ED47	LD I,A
FE5A	ED5E	IM2
FE5C	C9	RET
FE5D	00	NOP
FE5E	00	NOP
FE5F	00	NOP
FE60	3E3F OFF	LD A,3FH
FE62	ED47	LD I,A
FE64	ED56	IM1
FE66	C9	RET
FE67	00	NOP
FE68	00	NOP
FE69		Interrupt Routine Starts here.

By changing the cpu into IM2, we can cause the Spectrum to call our own machine code routines 50 times per second. To do this, we need to set the I register to a value where the cpu can find a suitable address for our routine. The value of I must, in the Spectrum, stay below 3FH as it is used when outputting the display — setting I to above 40H will give 'snow' on the screen.

So, we need to find somewhere, where the memory will always contain the same value, and that value will form part of a suitable address for our routine. Looking through the Rom we find that if $I = 9$, then locations 09FF H/0A00 H (2559/2560) contain the address FE69 H (65129) which is a suitable address for a routine in a 48K Spectrum. For a 16K version $I = 28H$ produces a jump to 7E5C H (32348).

Therefore, by changing the value of I to

9 or 40, we can make the cpu call our own routines. The routines in listing 1 show the method used to change/restore the I register and set the interrupt mode, so switching the interrupt routines on and off.

Listing 2 is the Basic program we will be using to Load our routines into place. Type it in and Save it, then Run. To check the switching routine, line 100 causes a jump back to the normal interrupt routine. Try switching it on and off — the machine should not crash and no effect should be noticed.

Note: the first figure in the line 100 always equals the number of bytes to be poked into place:

RAND USR 65110 (16K — 32330) turns ON RAND USR 65120 (16K 32340) — turns OFF.

Border. Add listing 3 to your base program and Save it, as with all routines before Running. This short routine sets the Border to be always the same as the permanent Paper colour — the demo program starting at line 200 shows this in action. Enter as a direct command *Poke 65131, 120* (16K 32350) and the Border will now flash as the contents of the timer (23672) is sent to the Border.

List 2(a)

```

1 REM List 2
10 REM BASE PROGRAM
  INTERRUPT ON/OFF
15 REM 48K SPECTRUM
25 REM START INTERRUPT WITH
  RAND USR 65110
28 REM END INTERRUPT WITH
  RAND USR 65120
30 REM © Alan D. Went 1983
40 CLEAR 65110
50 FOR A=65110 TO 65128: READ
B: POKE A,B: NEXT A
55 READ C: LET C=C+65128: FOR
A=65129 TO C: READ B: POKE A,B:
NEXT A
60 DATA 62,9,237,71,237,94,201
70 DATA 0,0,0,62,62,237,71,237
,85,201,0,0
90 REM INTERRUPT ROUTINE START
  AT LINE 100.
100 DATA 3,195,55,00

```

List 2(b) 16K

```

1 REM List 2 (b)
10 REM BASE PROGRAM
  INTERRUPT ON/OFF
15 REM 16K SPECTRUM
25 REM START INTERRUPT WITH
  RAND USR 32330
28 REM END INTERRUPT WITH
  RAND USR 32340
30 REM © Alan D. Went 1983
40 CLEAR 32329
50 FOR A=32330 TO 32347: READ
B: POKE A,B: NEXT A
55 READ C: LET C=C+32347: FOR
A=32348 TO C: READ B: POKE A,B:
NEXT A
60 DATA 62,40,237,71,237,94,20
1
70 DATA 0,0,0,62,63,237,71,237
,85,201,0
90 REM INTERRUPT ROUTINE START
  AT LINE 100.
100 DATA 3,195,55,00

```

Sound. We can make the Spectrum beep continuously, even when Running a program. Reload listing 2 and add listing 4, Save and Run, then Run line 200 (change values for 16K) and your Spectrum will sing to you!

If locations 65134 and 65137 (16K 32353 and 32356) are Poked with other values as shown, the tone can be changed. The higher the number, the purer the tone, but the less time allowed to spend running the program and it runs very slowly.

Break disable. One disadvantage of Basic programs, at times, is that they can be stopped, by pressing *Caps Shift/Space*.

The next interrupt routine will disable that function. This works by checking the system variable *Errnr* for error code *L Break* into program. When this is detected, the code for *Cont* is entered into the editing area and then, having ensured that the system variables *Oldppc* and *Ospcc* (see p175 Spectrum manual) are correct, a jump is made to the Rom routine that runs a direct command. This has the same effect as pressing *Cont* and *Enter* after a break. Thus, the program continues with the next statement.

To use this in your own programs, add listing 5 to the base program and merge into your program or, after running *Save*

"break" Code 65110,77 (16K 32330,77), Load into your program after Clear 65109 (32329) : Load "break" Code. Adding the line Rand Usr 65110 (32330) to your program will then turn the routine on.

Moving display. This routine is designed to show how the screen can be manipulated with an interrupt routine. The chosen lines of the display are moved one pixel to the left on each interrupt. This could be used, for example, to produce a moving landscape, with a game taking place overhead. The part of the screen that moves is a block, up to eight lines deep, starting from the top, middle or bottom of the screen.

When listing 6 has been added, *Saved and Run, Poke 65137,(32353)* with the number of lines to be moved and *Poke 65135 (32351)* with:

64 for top third of screen.

72 for middle third,

80 for bottom third.

The program at line 200 (listing 6) gives some examples of this in action.

Trace/Memory Free. This last and longest routine gives the Spectrum a trace command. This places on screen the line and statement number as the program is Run — also the amount of unused memory. The speed that the program runs can be adjusted from 75 percent normal speed to very slow.

One line of the screen is cleared and used as the status line. The first number shown is the memory report. Direct commands are checked for and shown as line 0000:01. The routine contains its own print routine, so that it will always function even with the printer running.

To use, *Poke 65199 (32418)* with the required speed (not above 40 approx), then turn the routine on. The speed can be changed when trace is on. After use in debugging, etc, it could be replaced in your final program with the break/disable routine previously described.

Note, to save code only; *Save "trace" Code 65110,176 (32330,176)* and reload as in the break/disable example.

In this article I have shown some of the ways in which interrupts can be used within programs — it is now up to you to improve them and write your own. When doing this, the following points must be borne in mind:

- (1) Always Save the contents of any register that you use and restore it again before turning to the main routine.
- (2) When an interrupt occurs, the cpu disables any further interrupt to prevent an interrupt service routine from being interrupted, thus forming an unbreakable loop. Therefore, always ensure that the *EI* (interrupt enable) command is used before returning to the main routine.
- (3) If you require the Spectrum to read the keyboard and your routine does not do so, end with a *JP 0038H* — this will read the keys, etc — and then return to the main routine. Otherwise, end service routine with a *Return* instruction. ■

List 3

```

90>REM INTERRUPT ROUTINE START
    AT LINE 100.
95 STOP
99 REM border 48K OR 16K
100 DATA 15,245,58,141,92,15,15
101,200,15,211,254,241,195,55,0:
102>BORDER
1000 REM DEMONSTRATION PROGRAM
1010 RANDOMIZE USR 65110
1020 INK 0: FOR A=0 TO 7: PAPER
A: PRINT "The border changes col
our with paper! Without a BORD
ER Command": PAUSE 100: NEXT a
1030 RANDOMIZE USR 65120

```

List 4

```

90>REM INTERRUPT ROUTINE START
    AT LINE 100.
95 STOP
99 REM SOUND 48K OR 16K
100 DATA 21,229,213,197,245,17,
101,0,33,16,0,205,181,03,241,193,
102,225,243,195,55,0: REM SOUND
103>STOP
1000 REM DEMONSTRATION PROGRAM
1010 RANDOMIZE USR 65110
1025 PRINT "SPECTRUM SOUNDS"
1030 FOR A=120 TO 10 STEP -10: P
OKE 65134,a: PRINT "POKE 65134 =
a: FOR b=100 TO 10 STEP -10: P
OKE 65137,b: PRINT "POKE 65137
b: PAUSE 25: NEXT b: NEXT a
1030 RANDOMIZE USR 65120

```

List 5

```

90>REM INTERRUPT ROUTINE START
    AT LINE 100.
99 REM BREAK DISABLE 48K OR 16
100 DATA 58,245,58,58,92,254,20
101,4,241,195,55,0,205,176,22,40
102,92,205,52,22,35,52,232,119,0
103,241,253,52,13,1,3,0,17,112,92
104,68,92,253,203,10,126,40,1,0,
105,184,253,54,10,255,251,195,24
4,18: REM break disable
109>STOP
1000 REM DEMONSTRATION PROGRAM
1010 RANDOMIZE USR 65110
1025 PRINT "THIS PROGRAM CANNOT
BE BROKEN INTO! CAPS SHIFT AND
SPACE WILL ONLY PAUSE THE PROGR
AM "
1030 FOR A=1 TO 1000: PRINT AT 1
0,10,A: NEXT A
1025 PRINT AT 16,0;"THIS WILL WO
RK WITH ANY BASIC PROGRA
M"
1030 RANDOMIZE USR 65120

```

Continued on page 23

SPECTRUM JOYSTICK INTERFACE

STILL PLENTY OF TIME FOR DELIVERY BEFORE CHRISTMAS



£9.95
(TWO-YEAR GUARANTEE)



ROBUST JOYSTICK

£9.75

QUICKSHOT JOYSTICK



£11.95

FROM: RAM ELECTRONICS (FLEET) LTD (PCW), 106 Fleet Road, Fleet Hampshire GU13 8PA. (02514) 5858

Send cheque or postal orders or ring with your Access or Visa card number

Enter quantity required in box

- Spectrum Joystick Interface @ £9.95
- Robust Joystick @ £9.75
- Quickshot Joystick @ £11.95
- Interface + Robust Joystick @ £18.50
- Interface + Quickshot Joystick @ £19.95
- Vic 20 standard 16K ram pack @ £27.95
- Vic 20 switched 16/3K ram pack @ £34.95
- Vic 20 switched 32/16/3K ram pack @ £49.95

* ALL PRICES INCLUDE VAT *
 * PLEASE ADD £1 p&p *
 * (OVERSEAS ORDERS £3) *
 * I enclose £..... *
 * Charge my Access/Visa £..... *
 * Name..... *
 * Address..... *
 * *
 * *

***** Joystick Interface and ram packs carry an unbeatable two-year guarantee *****

TO: RAM ELECTRONICS (FLEET) LTD (PCW), 106 Fleet Road, Fleet, Hants GU13 8PA

(Credit card payment for goods by return post.)

FINSBURY COMPUTER CENTRE

25-27 STROUD GREEN ROAD
LONDON N4 TEL: 01-263 0084/4481

**NORTH LONDON'S
LARGEST MICROCOMPUTER
CENTRE
BUSINESS COMPUTERS!
DUET 16 in stock**



ATARI 400 £149.00
ATARI 800 £299.99



SINCLAIR ZX81 £45.00
SPECIAL OFFER
SPECTRUM 16K £99.95
SPECTRUM 48K £129.95



COMMODORE VIC20 £149.99
INCLUDING STARTERPACK
COMMODORE 64 £229.00



DRAGON 32 £175.00



ORIC-1 48K £139.99



LYNX 48 £225.00



COLOUR GENIE 32K £168.00
SPECIAL OFFER

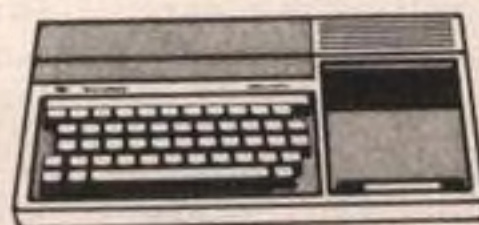

TEXAS TI 99-4A
£159.95



JUPITER ACE £69.95

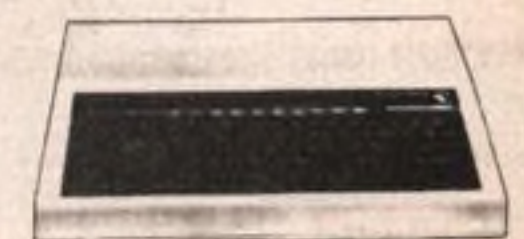

BBC MODEL B £399.00

WE CARRY PROBABLY THE WIDEST RANGE OF SOFTWARE PROGRAMS IN STOCK. PLEASE VISIT US FOR DEMONSTRATION ON ANY OF THE ABOVE COMPUTERS. DISK DRIVES, PRINTERS, CASSETTE RECORDERS, MONITORS, SPEECH SYNTHESISERS, LEADS, ETC., ALSO IN STOCK. ALL PRICES INCLUDE VAT. PRICES ARE CORRECT AT TIME OF GOING TO PRESS BUT ARE SUBJECT TO CHANGE.

We cannot list all the software we stock, so pick up the phone and ring 01-263 0084/4481 and ask. We'll be pleased to give you our prices.

Please send off the coupon or order by phone quoting your Access/Barclaycard No. Phone 01-263 0084/4481. Immediate despatch on receipt of order or cheque clearance.

FINSBURY COMPUTERS LIMITED
25/27 STROUD GREEN ROAD, LONDON N4

We open Monday, Tuesday and Saturday from 9.30 to 6.00
Wednesday 9.30 to 1.30
THURSDAY and FRIDAY 9.30 to 8.00

TO: FINSBURY COMPUTERS LTD
25/27 STROUD GREEN ROAD
LONDON N4

Please supply

Please add £3 for p&p to cost

I enclose my cheque for £.....

or charge my
Access/Barclaycard No.....

NAME.....

ADDRESS.....

..... SIGNATURE

DATARUN TAPE DUPLICATION SERVICE

High quality duplicating
All tapes verified
Prices from 29p
Short runs — no problem
Despatch normally within 10 days
Write or phone for a price list

HIGH QUALITY COMPUTER GRADE BLANK CASSETTES

C12	1-9	38p	plus 50p p&p
	10-99	35p	carriage at cost
	100-999	32p	carriage at cost
	1000+	29p	carriage at cost

All prices include VAT

DATARUN

81 Courtney Street, Manselton, Swansea SA5 9NT
Telephone (0792) 472135



GEM SOFTWARE

NEW RELEASES FOR CHRISTMAS

OH MUMMY!! Your party of archaeologists enter the pyramid in search of the mummies of the pharaoh's household. There are five burial chambers containing treasure, secret scrolls, keys, royal mummies and some nasty surprises. To pass from one chamber to the next, you must find the key and royal mummy, but beware, you may uncover a guardian, who will chase your group to avenge your desecration!! A Machine Code game for those with nerves of steel and great courage.

Price (LYNX) £7.95
Price (ZX81 and SPECTRUM) £4.95

TANK ATTACK. A machine code game for 1/2 players, defending supplies against computer controlled tanks. This game will stretch your reflexes to the limit as you battle with the enemy tanks. They won't be able to shoot back until they have supplies, but when they do, look out!! Joysticks required.

Price (BBC-B OS 1.0+) £7.95

CHRISTMAS SPECIAL OFFER (mail order only for DRAGON 32). Choose any three of the following titles for £15.90. A saving of £7.95

GAMES PACK I
ALIEN BLITZ

GAMES PACK II
GOLF

GAMES PACK III
SPACE MISSION

All prices include postage and packing. All cassettes despatched within 48 hours of receipt of order. Access orders welcome.

SPANNERMAN. Pete the Plumber has his work cut out! He's stuck in the boiler room and the pipes are leaking! Unless he can fix the leaks and stop the water rising he'll meet with a watery doom. To make matters worse, all sorts of nasties keep coming out of the woodwork!! A fantastic machine code game, that stretches you and your Lynx to the limit!!

Price (LYNX) £7.95

UTIL 1. Two very useful programs for your BBC-B. Both tested on OS 1.0 and above. **Character Define** gives you a very comprehensive and simple way to quickly create all manner of user defined characters. **Envelope Editor** will enable you to unravel the complexities of the Sound and Envelope commands, so that you can produce exactly the sound you require. The ship!! In SUB CHASE you must depth charge the wolf pack.

Price (BBC-B OS 1.0+) £9.95

GEM SOFTWARE

UNIT D, THE MALTINGS, STATION ROAD, SAWBRIDGEWORTH, HERTS
Telephone (0279) 723567/723518

A cosmic experience

Michael Pearce presents a Cosmic Lander program written on OS 1.2 for model B or 32K A

With a minimum amount of fuel left, your space-craft is orbiting the planet below. Gravity and strong cross-winds are pulling your craft quickly down — the only hope you have of saving your ship is by landing it on one of the pressure pads.

But, this task will not be easy. The slightest movement or too fast landing will lead to your ship being blown up. Also, cosmic stars float above the surface and on some occasions will cause an explosion. On some screens, landing pads do not appear, so death is imminent no matter what happens. The more screens you clear, the more intense the winds become.

The program has full instructions and a signature tune. The landing screen is drawn in hi-res colour graphics, with stars and a 3D perspective graphics landscape. Landing pads are randomly placed. The ship is two characters high. Fuel readout is at the top of the screen.

Keys for the game are:

Z . . . Left

C . . . Right
M . . . Thrust

It is unwise to keep your hand on a key for too long. Once the craft starts drifting too fast, it will be hard to stop. If you crash into the top, or sides, of the screen, your craft will explode.

If the screen set-up is not to your liking, add this line:

```
655 IF A$="P" THEN GOTO 340
```

On the press of P, the screen will be redrawn, though the variables will stay the same.

Variables

CA	Craft position across screen
CB	Craft position down screen
DRIFT	Wind force
DEC	Descent rate
CAB	Ships step of movement across screen
SN	Ships to go
SC	Score

Notes

10-230 Instructions and signature tune

240-330	User defined graphics and sound effects
350-560	Set up screen display
570-680	Prints craft and waits for keyboard input
690-730	Deletes ship
740-830	Checks for crash or land
830-900	Crashes, checks for end of game
910-950	Lands, adds up score
960-1000	Updates instruments
1010-1060	End of game, wait for new start

Proc statements

PROCscreen	Sets up screen
PROCcraft	Print craft waits for instructions
PROCmoving	Blacks out craft
PROCpos	Checks for crash or land
PROCcrash	Crashes craft
PROCland	Lands craft
PROCinst	Updates instruments
PROCend	Ends game

Conversion to BBC model A

```
Delete lines 10, 230
The following lines should read:
320 MODE 5:VDU19,0,4,000:VDU23:8202,0:0:
0:VDU5
400 FOR N= 1 TO20: X=RND(1240):Y=RND
(700) + 200
410 Z=RND(2)+1:GCOL1,Z:IF Z=2 THEN MOVE
X,Y:PRINTCHR$246
420 NEXT MOVE 0,0
520 GCOL0,3:MOVE N-2,250:DRAW N+75,250
750 IF POINT (CA+25,CB-70)=3 THEN 760 ELSE
780
850 MOVE CA,CB:GCOL0,3:PRINT CHR$
242:MOVE CA,CB-32:PRINT CHR$243
```

COSMIC LANDER
FUEL

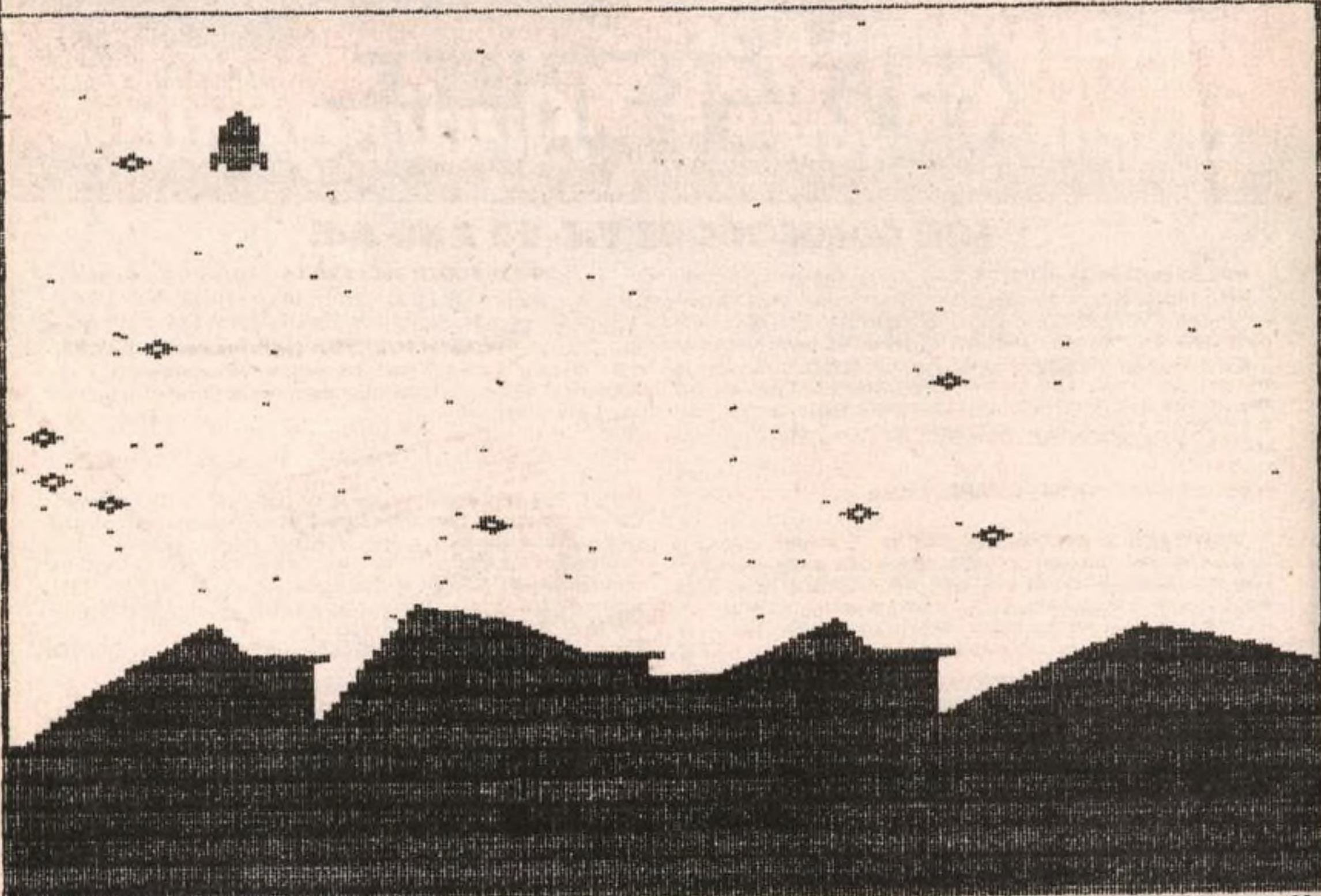

Continued on page 28

SUPERCODE

—for 16K and 48K Spectrum

100+ ROUTINES

This is a superior machine code tool kit with one hundred machine code routines that are relocatable for use in your own BASIC and/or machine code programs, the combined user friendly BASIC program, 48k Spectrum only, gives easy access to all routines: ● Index of routines. ● Call up details of each routine including all information required to tailor the routine to your needs. ● Demonstration of how the routine works under software control, the demonstration is repeatable. ● Save and verify individual routines. ● Comprehensive user guide.

1. Block Memory Insert	24. Sci-Fi Character Set	47. Wait-Key
2. Block Line Delete	25. Memory Available	48. Strings to Upper Case
3. Chr\$ Swap	26. Line Renumber	49. Strings to Lower Case
4. Chr\$ Scramble	27. Uni-Note Sound-Gen	50. Program to Upper Case
5. Super-Renumber	28. Dual-Note Sound-Gen	51. Program to Lower Case
6. 2 Byte Converter	29. Uni-Beep Simulator	52. Confuse
7. Dec - Hex Converter	30. Multi-Beep Simulator	53. Clarify
8. Hex - Dec Converter	31. Screen Fill	54. Space Saver
9. Remkuli Condenser	32. Screen Store	55. Screen Overprint
10. On Error Goto	33. Screen Exchange	56. Screen Invert
11. On Break Goto	34. Protect Program	57. Clear All
12. Free-Scroller	35. Block Copy	58. Ink Change
13. Non-Deletable Lines	36. Contract	59. Paper Change
14. Border Effects	37. Expand	60. Flash On
15. Screen Search	38. Expand Rem	61. Flash Off
16. Variables Search/List	39. Append	62. Bright On
17. 24-Line Printing	40. Count Program	63. Bright Off
18. Star Draw	41. Tape Header Reader	64. Screen-Print
19. Flash Switch	42. Address	65. Rand. Number Generator
20. Bright Switch	43. Checker-Board	
21. Paint Shape	44. Remove Colours	
22. Record Sound	45. Display Memory	
23. Replay Sound	46. Hex Loader	

Routines 66-100. Screen routines
SUPERCODE £9.95

Also available at Boots, W.H. Smith and all good computer shops. Send SAE for Catalogue.

DELIVERY:
UK—prices include VAT and postage & packing.
EUROPE—add 80p per program
ALL OTHER PLACES—for air mail add £2 for the first program and 50p for each subsequent program. Surface delivery add 80p per program.

CP software

Send Cheque, Postal Order or Access No. to:
CP SOFTWARE, Dept PCW1A
17 Orchard Lane, Prestwood,
Bucks HP16 0NN

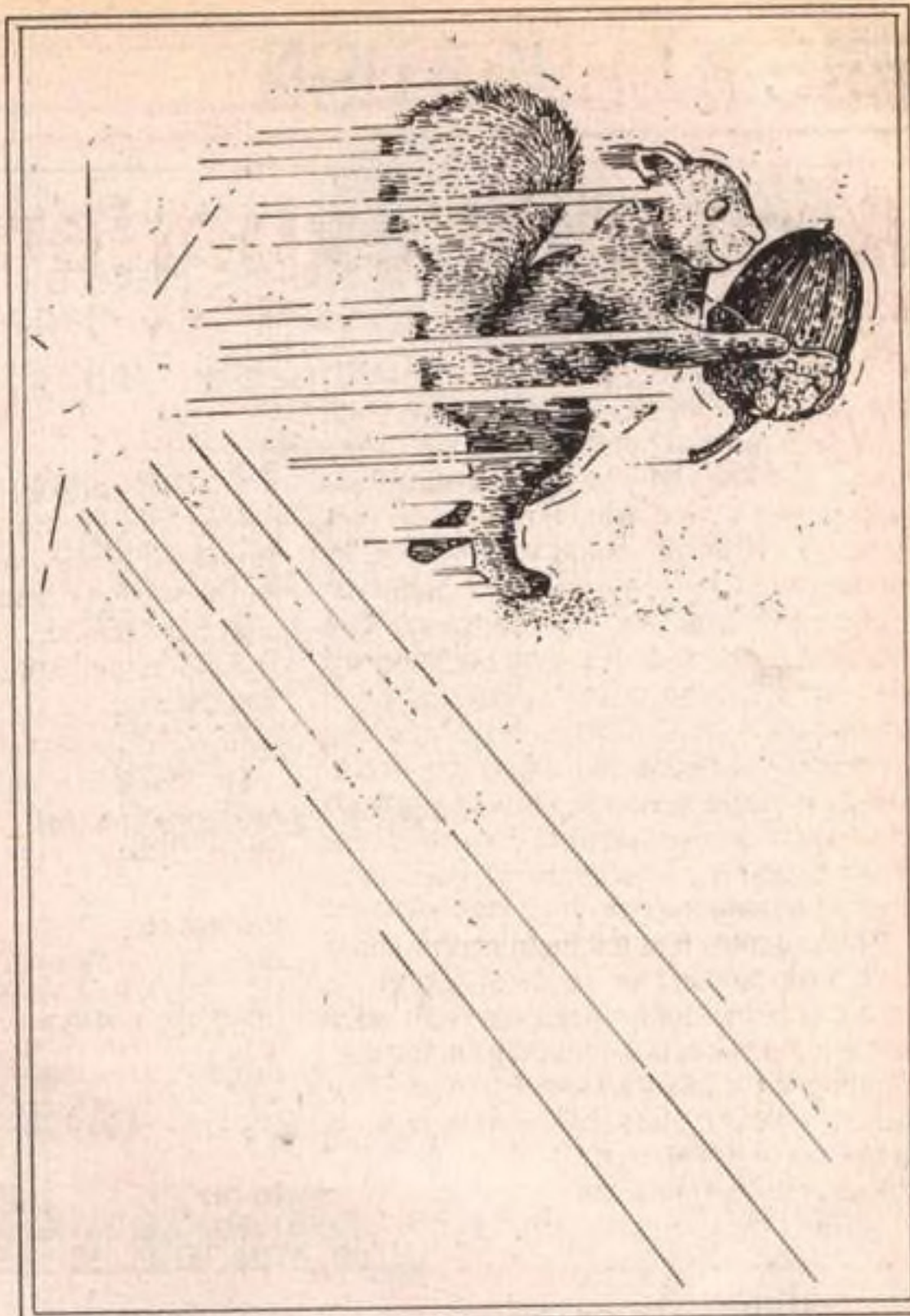

PROGRAMMING AIDS AND LANGUAGES FROM . . .

Audiogenic LTD

FOR COMMODORE VIC-20 AND 64!

VP052 BUTI PLUS - £39.95 - Basic Programming Aid Commands PLUS Machine Code Monitor PLUS 3K Expansion! Basic aids include - APPEND, AUTO, DELETE, DUMP, EDIT, FIND, HELP, RENUMBER, REPEAT, STEP, TRACE, UNNEW, VIC, and DEC to HEX. Monitor Commands - ASSEMBLE, DISASSEMBLE, CENTRONICS, FILL, GO, MEMORY, HUNT, REGISTER, PRINTED DISASSEMBLE, LOAD, QUICK EXECUTE, WALK CODE, SAVE, TRANSFER, EXIT.

VP074 MONITOR VIC - £19.95 - Monitor on its own. Commands as above.

SS074 MONITOR 64 - £29.95 - 64 version. Commands as above.

VP078 MIKRO ASSEMBLER - £48.95 - Cartridge Assembler program for the VIC - Includes 3K extra memory. Write your machine language source code on Basic Lines which can be manipulated using the included toolkit commands. MIKRO uses standard MOS mnemonics, and features ASSEMBLER and DISASSEMBLER, plus TIM monitor commands, and special hi-res, sound, and joystick extensions.

SS076 FORTH 64 - £29.95 - Audiogenic Forth is very fast because it compiles right down to machine code, and very compact because it uses special screen compression routines. Audiogenic Forth contains a dictionary of over 200 Forth words, but the great thing about Forth is that you can define your own commands! Audiogenic Forth gives you full error messages (instead of codes), a full scrolling screen editor, and a comprehensive manual.

VP076 FORTH VIC - £24.95 - As above, but includes special VIC colour and sound commands. This version must be used in a motherboard with 8K+ expansion.

VP076/M FORTH VIC (with memory) - £39.95
- As VP076, but includes 3K expansion built-in so that you don't need a motherboard and expansion.

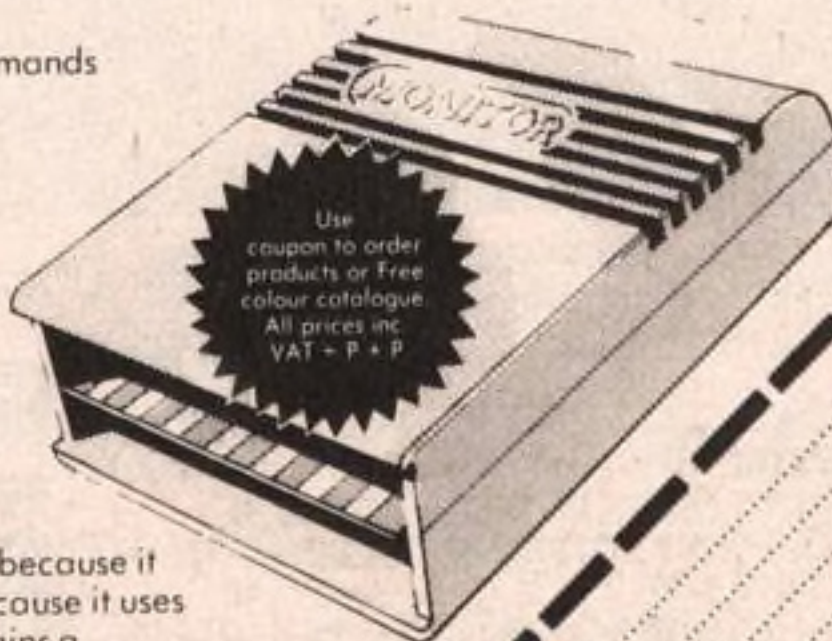

PLEASE SEND ME

NAME

ADDRESS

(PRODUCT & CODE NO.)

AUDIOGENIC LTD.,
P.O. BOX 88,
READING,
BERKS.

```

10REM "COSMIC LANDER BY Michael Pearce"
20REM "PROGRAMMED ON THE BBC MODEL A
32K OS. 1.2 IN APPROX 26K"
30MODE7:FX15,0
40PRINTCHR$141;"COSMIC LANDER":PRINTC
HR$141;"COSMIC LANDER"
50PRINTCHR$136;"BY Michael Pearce"
60PRINT'"MISSION TO LAND TO YOUR SPAC
E CRAFT ON ASET UP PRESSURE PAD"
70PRINT'"FUEL IS LOW AND WHEN RAPPID
PIPS SOUND IT IS AT ITS MINIMIUM"
80PRINT'"THE MOON HAS A HEAVY CROSS W
IND WHICH DRIFTS YOUR ";
90PRINT"SHIP ACROSS THE SCREEN"
95PRINT"ALSO BEWARE OF FLOATING STARS"
100PRINT'"LAND CAREFULLY ANY MOVEMENT
ON A"
110PRINT"PRESSURE PAD MIGHT LEAD TO AN
EXPLOSION"
120PRINT'"KEYS...."
130PRINT"Z.....LEFT"
140PRINT"C....RIGHT"
150PRINT"M...THRUST"
160PRINT'"FUEL BONUS AFTER EVERY LANDI
NG"
170REPEAT:READF,D:IF F=99 GOTO230
180IFF=0SOUND1,0,0,D ELSE SOUND1,-10,F,D
190SOUND1,0,0,1
200UNTIL 0
210DATA56,4,80,24,88,24,96,32,0,4,96,4,
100,16,100,8,96,12,80,4,96,8,88,32
220DATA99,0
230PRINTCHR$136;"Any key to start":A=
GET
240ENVELOPE2,16,16,1,1,200,0,0,126,0,0,
-126,80,80
250ENVELOPE5,6,2,20,16,16,0,0,126,0,0,
-126,126,126
260ENVELOPE1,1,1,1,1,5,10,60,80,-1,0,0,
50,0
270VDU23,240,8,8,28,28,62,62,62,62:VDU
23,241,62,62,62,127,127,127,93,93
280VDU23,242,0,16,16,16,16,68,56,254:V
DU23,243,56,68,16,16,16,16,0,0
290VDU23,244,255,255,255,255,255,255,2
55,255:VDU23,245,24,24,24,24,0,0,0,
65
300VDU23,246,0,8,28,54,28,8,0,0,0
310SN=3:SC=0:W=3:A$=""
320MODE2:VDU19,0,4,0,0,0:VDU23,8202,0;
0;0;:VDU5
330CA=200:CB=800:DRIF=RND(W)-(W/2):DEC
=-10:CB=0:FUEL=17
340CLS:VDU5
350PROCscreen
360PROCCRAFT:PROCMOVEING:PROCINST:PROCP
OS
370GOTO360:GOTO330
380DEFPROCscreen
390GCOL0,7:MOVE0,0:DRAW0,900:DRAW1279,
900:DRAW1279,0:DRAW0,0
400FORN=1TO70:X=RND(1240):Y=RND(700)+2
00
410Z=RND(11)+1:GCOL1,Z:IFZ=2THENMOVEX,
Y:PRINTCHR$246
420MOVEX,Y:PLOT 69,X,Y:NEXT:MOVE0,0
430FORC=1TO3:FORN=1TO1700STEP100
440GCOL0,C:MOVE500,0
450PLOT85,N,RND(200-C*30)+200-C*70:NEXT
460MOVE0,0:PLOT85,1280,0:MOVE0,0:IFC=1
THEN480ELSENEXT
470ENDPROC
480FORN=10TO1200
490IFPOINT(N,250)=1ANDPOINT(N+2,250)=0
ANDPOINT(N+75,250)=0THEN510ELSENEXT
500GOTO540
510MOVEN-2,250:MOVEN+65,250:GCOL0,1:PL
OT85,N+65,100
520GCOL0,6:MOVEN-2,250:DRAWN+75,250
530MOVEN-2,247:DRAWN+75,247:NEXT
540GCOL0,3:MOVE10,1005:PRINT"COSMIC LA
NDER"
550MOVE10,955:PRINT"FUEL":MOVE0,0
560NEXT
570DEFPROCCRAFT
580GCOL0,5
590MOVECA,CB:PRINTCHR$(240):MOVECA,CB-
32:PRINTCHR$(241)
600GCOL0,3:MOVECA,CB-32:PRINTCHR$(245)
610*FX15,0
620A$=INKEY$(20)
630IFA$="Z"THENCAB=CAB-3:SOUND0,1,4,5
640IFA$="C"THENCAB=CAB+3:SOUND0,1,4,5
650IFA$="M"THENDEC=DEC+3:FUEL=FUEL-1:S
OUND0,-2,4,10
660IFA$<>" "THENTIME=0:REPEATUNTILTIME=
20
670IFA$=""THENDEC=DEC-1:CB=CAB+DRIF
680ENDPROC
690DEFPROCMOVEING
700GCOL0,0
710MOVECA,CB:PRINTCHR$240:MOVECA,CB-32
:PRINTCHR$241
720CA=CA+CAB:CB=CB+DEC
730ENDPROC
740DEFPROCPOS
750IFPOINT(CA+25,CB-70)=6THEN760ELSE780
760IFCAB<6ANDCAB>-6THEN770ELSEPROCCRASH
770IFDEC<10ANDDEC>-10THENPROCLAND ELSE
PROCCRASH
780IFPOINT(CA+25,CB-70)=10RPOINT(CA+20
,CB-60)=2THENPROCCRASH
790IFCA>1200THENPROCCRASH
800IFCA<10THENPROCCRASH
810IFCB>800THENPROCCRASH
820IFFUEL<1THENPROCCRASH
830ENDPROC
840DEFPROCCRASH
850MOVECA,CB:GCOL0,12:PRINTCHR$242:MOV
ECA,CB-32:PRINTCHR$243
860SOUND0,5,4,20:SN=SN-1
870VDU4:PRINTTAB(2,10);"FUEL BONUS GON
E":PRINTTAB(3,12);"CRAFTS LEFT ";SN
880TIME=0:REPEATUNTILTIME=700
890IFSN=0THENPROCEND
900GOTO330
910DEFPROCLAND
920GCOL0,14:MOVECA,CB:PRINTCHR$240:MOV
ECA,CB-32:PRINTCHR$241
930GCOL0,12:MOVECA,CB-32:PRINTCHR$245
935*FX21,4
940SOUND1,2,0,40:VDU4:PRINTTAB(4,10);"
FUEL BONUS ";FUEL
950TIME=0:REPEATUNTILTIME=700:SC=SC+20
+FUEL:W=W+2:GOTO330
960DEFPROCINST
970VDU4:FORN=5TOFUEL:COLOUR7:PRINTTAB(
N,2);CHR$244:NEXT
980PRINTTAB(N+1,2);" "
990IFFUEL<5THENSOUND2,-10,150,2
1000VDU5:ENDPROC
1010DEFPROCEND
1020VDU4:PRINTTAB(1,10);" END OF GAME
1030PRINTTAB(3,12);" SCORE ";SC;" "
1040PRINTTAB(1,14);"KEY TO PLAY AGAIN"
1050*FX15,0
1060A=GET:RUN

```

THE FABULOUS CASSETTE

50

FROM **cascade**

50 GAMES ON ONE GREAT CASSETTE

**ONLY
£9.95**

DON'T MISS THIS
INCREDIBLE OFFER

50 FANTASTIC
GAMES ON
ONE CASSETTE

ONLY £9.95 (INC. P&P and VAT)



EXPRESS DELIVERY - ORDER NOW

Please send me by return of post, Casette 50 at £9.95 per tape. I enclose a cheque/postal order for made payable to Cascade Games. £

Name

Address

Post Code

Country

Dealers & Stockists enquiries welcome.

Please send me (tick appropriate box) -

Spectrum VIC



Cascade Games,
Suite 4, 1-3 Haywra Crescent,
Harrogate, N. Yorkshire, HG1 5BG,
England.
Telephone: (0423) 504526

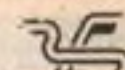

Unrestricted access

Bernice Hennessy explains how to obtain machine code access to Basic functions

In his article "A Routine Matter" (*PCW* 20-26 October), Peter Whittaker describes a very useful technique for calling Basic Rom routines from a machine code program. In a similar manner, you can access the functions of Basic and also any additional Basic commands provided, for example by disc operating systems or some hardware add-on modules.

To do this, you need to know that the Basic system uses a list of reserved commands and functions, together with their corresponding addresses. During Basic initialisation, pointers to these are set up in Ram as follows:

\$120 Number of normal reserved words

\$121 Address of normal reserved words list
 \$123 Address of statement despatch table
 \$125 Number of function reserved words
 \$126 Address of function reserved words list
 \$128 Address of function despatch table

Listings 1 and 1a are generalisations of Peter Whittaker's program which display both normal reserved words and Basic functions. You will see that the statement despatch table only contains *Exec* addresses for tokens up to 186 Renum, because later tokens are always used in conjunction with an earlier one. Functions are represented by a pair of tokens, the first always being \$FF.

The lists of reserved words and the addresses of the subroutines to implement

them are normally stored in the Basic Rom. The way in which extra commands are added to Basic (or existing commands given new meanings) is to move the reserved word list and despatch table (ie, list of addresses) into either protected Ram or the cartridge Rom area. It is then possible to redefine commands and their meanings as required. Listing 2 shows an example of this where the function reserved word list and function dispatch table have been moved into Ram and the following modifications made:

The INT and MEM functions no longer exist.
 Token 255 129 has been redefined as QNT and points to \$8C31 (the old MEM routine).
 Token 255 155 has been redefined as % and points to \$7CE5 in Ram where a machine code routine gives the function its meaning.

Using this technique, it is possible to redefine Basic words at will (although you change the meaning of existing words at your peril!) and to define meanings for extra Basic commands which you can add to your Dragon's repertoire. ■

```

5 REM DRAGON—BASIC TOKENS BY B.HENNESSY
10 PRINT#-2
20 A=127:B=PEEK(289)*256+PEEK(290):C=PEEK(291)*256+PEEK(292):
  D=127+PEEK(288)
30 PRINT#-2,PEEK(288);"NORMAL RESERVED WORDS — LIST BEGINS
  AT";B;" — ADDRESSES BEGIN AT";C
35 T$="":B=B-1
40 GOSUB 200
50 PRINT#-2
60 A=127:B=PEEK(294)*256+PEEK(295):C=PEEK(296)*256+PEEK(297):
  D=127+PEEK(293)
70 PRINT#-2,PEEK(293);"FUNCTION RESERVED WORDS — LIST BEGINS
  AT";B;" — ADDRESSES BEGIN AT";C
75 T$="255":B=B-1
80 GOSUB200
90 STOP
200 PRINT#-2,"TOKEN";TAB(20)"BASIC";TAB(40)"EXEC ADDRESS"
205 PRINT#-2,TAB(41);"DEC.  HEX."
210 A=A+1:IF A>D THEN RETURN ELSEPRINT#-2,T$;A;TAB(20)" ";
220 B=B+1:IF PEEK(B)<128 THEN PRINT #-2,CHR$(PEEK(B));:
  GOTO220 ELSE PRINT#-2,CHR$(PEEK(B)-128);
230 E=PEEK(C)*256+PEEK(C+1):C=C+2:PRINT#-2,TAB(39)E;"
  ;HEX$(E):GOTO210
240 END
    
```

Fig 1

34 FUNCTION WORDS — LIST BEGINS AT 32450 — ADDRESSES BEGIN AT 32583

TOKEN	BASIC	EXEC ADDRESS	DEC.	HEX.		
255 128	SGN	37925	9425	255 145	CHRS	36386 8DD2
255 129	QNT	35889	8C31	255 146	EDF	47104 B800
255 130	ABS	37950	943E	255 147	JOYSTK	47885 B88D
255 131	POS	39646	9ADE	255 148	FIX	39254 9956
255 132	RND	38770	9772	255 149	HEXS	40974 A00E
255 133	SQR	38551	9697	255 150	LEFTS	36337 8DF1
255 134	LOG	37436	923C	255 151	RIGHTS	36366 8E0E
255 135	EXP	38675	9713	255 152	MIDS	36373 8E15
255 136	SIN	38865	97D1	255 153	POINT	47684 BA44
255 137	COS	38859	97CB	255 154	INKEYS	46998 B796
255 138	TAN	38934	9816	255 155	%	31973 7CE5
255 139	ATN	39031	9077	255 156	VARPTR	39668 9AF4
255 140	PEEK	36582	8E96	255 157	INSTR	39860 9884
255 141	LEN	36295	8DC7	255 158	TIMER	40281 9059
255 142	STR\$	35904	8C40	255 159	PPOINT	42695 A6C7
255 143	VAL	36444	8E5C	255 160	STRINGS	39812 9884
255 144	ASC	36326	8DE6	255 161	USR	40221 9D1D

Fig 2

Continued on page 33

"If you buy Android One, you can give up any hope of spending stress-free evenings with your Spectrum..."

HOME COMPUTING WEEKLY

PERSONAL
COMPUTER
NEWS

POPULAR
COMPUTING
WEEKLY



HOME
COMPUTING
WEEKLY

GUN LAW

Re-live the excitement of the wild west in this slick action game.

SERPENTS TOMB

Seek the crypt of Xetrov and defy the great serpent to remove the treasure.

ASTRAL CONVOY

Journey through hyperspace to defend convoys against alien attack ships.

DEALER ENQUIRIES WELCOME

Contact us at: 280 Brooklands Road, Manchester M23 9HD, or Phone 061-973 9580

PLEASE RUSH ME:

SPECTRUM 16/48K
(KEYBOARD/JOYSTICK OPTION)

ANDROID ONE(S) **£5.95 EACH.**

GUN LAW(S) **£5.95 EACH.**

ZX 81 16K

ASTRAL CONVOY(S) **£3.95 EACH.**

SERPENTS TOMB(S) **£3.95 EACH.**

SPECIAL OFFER
£1 OFF ANY TWO GAMES

TOTAL VALUE **£** _____

Enclose PO/cheque payable to VORTEX SOFTWARE

NAME _____

ADDRESS _____

Send to Mail Order Address:
VORTEX SOFTWARE
26 CRAWFORD ROAD, HATFIELD,
HERTS. AL10 0PG.



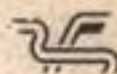

76 NORMAL RESERVED WORDS — LIST BEGINS AT 32819 — ADDRESSES BEGIN AT 33108

34 FUNCTION RESERVED WORDS — LIST BEGINS AT 33226 — ADDRESSES BEGIN AT 33360

TOKEN	BASIC	EXEC DEC.	ADDRESS HEX.	TOKEN	BASIC	EXEC DEC.	ADDRESS HEX.
128	FOR	33864	8448	167	EDIT	39269	9965
129	GO	34233	8589	168	TRON	39641	9AD9
13p	REM	34326	8616	169	TROFF	39642	9ADA
131		34326	8616	170	LINE	42825	A749
132	ELSE	34326	8616	171	PCLS	43200	A8C0
133	IF	34375	8647	172	PSET	42735	A6EF
134	DATA	34323	8613	173	PRESET	42739	A6F3
135	PRINT	36925	903D	174	SCREEN	43518	A9FE
136	ON	34421	8675	175	PCLEAR	43545	AA19
137	INPUT	34683	872B	176	COLOR	43220	A8D4
138	END	34898	8532	177	CIRCLE	45624	B238
139	NEXT	34857	8829	178	PAINT	44167	AC87
140	DIM	35467	8A88	179	GET	43768	AAF0
141	READ	34679	8777	180	PUT	43763	AAF3
142	LET	34492	868C	181	DRAW	45137	B051
143	RUN	34213	85A5	182	PCOPY	43710	AA8E
144	RESTORE	34868	8514	183	PMODE	43439	A9AF
145	RETURN	34291	85F3	184	PLAY	44477	AD8D
146	STOP	34105	8539	185	DLOAD	41033	A049
147	POKE	36589	8E9D	186	RENUM	48442	9DFR
148	CONT	34144	8568	187	TAB(21319	5347
149	LIST	36522	8EAA	188	TO	52809	CE49
150	CLEAR	34161	8571	189	SUB	20180	4ED4
151	NEW	33813	8415	190	FN	16706	4142
152	DEF	40065	9C81	191	THEN	54096	D350
153	CLOAD	46884	B6D4	192	NOT	20435	4FD3
154	CSAVE	46722	B682	193	STEP	21078	524E
155	OPEN	47144	B828	194	OFF	58259	C453
156	CLOSE	46668	B64C	195	+	28946	51D2
157	LLIST	36516	8EA4	196	-	19535	4C4F
158	SET	47578	B9D2	197	*	51013	C745
159	RESET	47619	BA03	198	(/)	22736	5808
160	CLS	47711	BA5F	199	^	21321	5349
161	MOTOR	47489	B981	200	AND	52883	CE43
162	SOUND	47770	BA9A	201	OR	20435	4FD3
163	AUDIO	47839	BADF	202	>	21569	5441
164	EXEC	46968	B770	203	=	52801	CE41
165	SKIPF	47134	B81E	204	<	21710	54CE
166	DEL	48289	9061	205	USING	28549	5045
167	EDIT	39269	9965				

Fig 1a

SIMPLE TO USE

You want to program your own Arcade Games?

Software STUDIOS Games Designer

Now you can! Produce your own
SPRITE BASED MACHINE CODE
Arcade Games

NO programming knowledge needed
EIGHT pre-programmed games included

**48K SPECTRUM
£14.95**

Marketed exclusively by Quicksilva Ltd

I enclose cheque/PO for £14.95
Send to Software Studios
Quicksilva Mail Order
55 Haviland Road
Ferndown Industrial Estate
Wimborne, Dorset BH21 7PY
Telephone (0703) 20169

Name

Address

.....

.....



TURN YOUR PROGRAMME UPSIDE DOWN

Now you can add another dimension to your games.
Swap direction, swap functions, confuse your friends.
In fact you can add almost any twist to your games with
Stonechip's Programmable Joystick Interface.

You can also listen to them
with Stonechip's Echo Amplifier.



Programmable Joystick Interface. This also enables any Spectrum software to be used with a joystick, irrespective of which keyboard keys have been chosen for function.

Programming is easy using only a single switch. Switch one way to program and another way to play. No tapes to load or links to worry about — all programming is achieved by hardware. Used with Atari-compatible joysticks. Simply plugs into rear expansion port of ZX-Spectrum. No other connections to make, no additional power supply required.



Echo Amplifier. How would you like to listen to the sound output from your ZX-Spectrum without ear strain? The Stonechip Echo amplifier can do this for you as well as easing the tedium of saving or loading of tapes and enlarging the range of tape recorder compatibility with the computer. The amplifier has volume control over a range adequate for most uses, and a tone control for harsh or mellow sounds. A switched interface removes the need to swap leads during 'SAVE'ing or 'LOAD'ing. Leads are left connected all the time and the desired function is selected on the three position switch by the user. Use of the 'CUE' facility enables an audio cue to precede the program being 'SAVE'd' on tape, a decided advantage when searching through a multi-program tape. The Echo simply plugs into the Ear, Mic and Power sockets of the computer and does not require an additional power supply. The expansion port at the rear of the computer is left free for use with other peripherals and the unit is housed in an attractive case custom designed to complement the ZX-Spectrum.

STONECHIP
ELECTRONICS

Stonechip Ltd. Brook Trading Estate Deadbrook Lane Aldershot Hants. GU12 4XB. Tel: (0252) 318260

To: Stonechip Electronics, Unit 9, The Brook Industrial Estate, Deadbrook Lane, Aldershot, Hants.
Telephone: (0252) 318260.

Please forward me the following products:

Name

Address

DEALER ENQUIRIES WELCOME
Delivery approx. 14 days



Unlock Your Imagination

SCOPE

Computer Graphics Language

- ★ A VERY POWERFUL, TRUE MULTITASK LANGUAGE
- ★ AS FAST AS MACHINE CODE
- ★ SIMPLER THAN BASIC

Write Machine Code in a fraction of the time currently required

SCOPE is available from most good quality dealers and selected branches of

WHSMITH

For details of how to get your games published commercially contact ISP Marketing

TECHNICAL DETAILS

SCOPE is a fully structured multitask language specifically for writing *graphics, animation and sound*. Being fully compatible with BASIC it is ideal for writing both arcade and adventure style games. Additionally, with SCOPE present in high memory it can be used as an assembler with SCOPE words as plain language mnemonics. Therefore no knowledge of machine code is required. The language is extremely easy to comprehend and is very powerful indeed providing many features not available from BASIC.

SCOPE HAS TO BE USED TO BE BELIEVED

48K SPECTRUM



CLIP THE COUPON NOW AND UNLOCK YOUR IMAGINATION

Post to: ISP Marketing Ltd, Crown House, 380 High Street, Godalming, Surrey GU7 1JF
 Tel: Godalming (048688) 24151 Please rush me _____ copies of the SCOPE computer graphics language tape and instruction manual at £11.95 inc p & free.

Name _____
 Address _____

Block capitals please

Dealer Enquiries Welcome

PRICE
£11.95

A registered connection

Pete Gerrard takes a look at some of the registers connected with the Sid chip

Last week I gave you some of the fundamental information regarding the use of the 6581 Sid chip in your Commodore 64.

While space precludes an in-depth look at everything connected with the chip, this week we're going to take a detailed look at just some of the more interesting registers, starting with register 54276.

At this point it would be useful to dig out last week's copy, and have the Sid memory map in front of you.

Control Register

This is the most important register of them all, containing eight control bits with the following functions:

Gate — Bit 0

This controls the envelope generator for voice 1, and when this bit is set to a '1' the envelope generator is triggered and the Attack/Decay/Sustain (or ADS) cycle is begun.

When this bit is reset to a zero, then the release part of the cycle begins.

This envelope generator controls the amplitude of voice 1 as it appears at the audio output, and must therefore be triggered in order for the selected output of voice 1 to be audible.

Sync — Bit 1

When set to a '1' this synchronizes the fundamental frequency of voice 1 with the fundamental frequency of voice 3, producing what are known as 'hard sync' effects.

Varying the frequency of voice 1 with respect to voice 3 produces a wide range of complex harmonic structures from voice 1 at the frequency of voice 3.

In order for this to take place, obviously voice 3 must be set to some frequency or other, preferably lower than that of voice 1, but naturally higher than zero. Nothing else connected with voice 3 has any effect on Sync.

Ring Mod — Bit 2

When set to a '1' this bit replaces the triangle waveform of voice 1 with a ring modulation combination of voices 1 and 3: obviously, one must previously have selected the waveform of voice 1 to be a triangle one!

Varying the frequency of voice 1 with respect to voice 3 produces a wide range of non-harmonic overtone structures. Again, nothing else connected with voice 3 has any effect on Ring Mod.

Test — Bit 3

This bit, when set to a '1', resets and holds voice 1 at zero, until the bit is cleared.

The noise waveform of voice 1 is also reset, and if a pulse wave has been selected this is held at a DC level.

Triangle — Bit 4

When this is set to a '1', the triangle waveform is selected for voice 1. This is low in harmonics, and thus produces a mellow, reed-like note.

Sawtooth — Bit 5

When this is set to a '1', the sawtooth waveform is selected for voice 1. This is rich in harmonics, and thus produces a brassy, trumpet-like note.

Pulse — Bit 6

When this is set to a '1' the pulse waveform is selected for voice 1. The harmonic content of this waveform can be varied by altering the pulse width registers, producing a wide variety of different musical (and not so musical) sounds.

Sweeping through the pulse widths can produce some dynamic effects, and add a sense of motion to the sound. Also worthy of experiment is a rapid altering of pulse widths.

Noise — Bit 7

When set to a '1', the noise waveform is selected for voice 1. This is a totally random signal which changes at the frequency of voice 1, and thus is of most use in generating purely sound 'effects', like missiles taking off, engines revving, or explosions.

One of the above waveforms must be selected in order for voice 1 to produce any audible sound, although that sound can be turned off without un-selecting a waveform, as the voice at the end is a function of the envelope generator only.

You cannot add more than one waveform together to produce something totally different from the above four, although you're welcome to try!

Filtering techniques

This concerns memory locations 54293 and 54294, known as Freq Lo/Freq Hi — registers \$15 and \$16.

As bits 3 to 7 of register \$15 are not used, these two combine together to form an 11-bit number which linearly controls the cut-off, or centre frequency of the programmable filter. The approximate cut-off frequency is obtained from:

$$FC_{out} = ((6.6E - 8 + FC_n \cdot 1.28E - 8)/C) \text{ Hz}$$

where FC_n is the 11-bit number in the above two registers and C is the value of the two filter capacitors connected to pins 1 to 4, or in our case 2200 picoFarads.

This gives an approximate filter range of 30 Hz to 12 KHz, according to:

$$FC_{out} = (30 + FC_n \cdot 5.8) \text{ Hz}$$

Res/Filt — Register \$17 (54295)

Bits 4 to 7 of this register control the

resonance of the filter, where resonance emphasises components of the frequency at the cut-off frequency of the filter, thus causing a sharper sound.

There are 16 resonance settings, ranging linearly from no resonance, when this is set to zero, or maximum resonance, when it is set to 15.

Bits 0 to 3 determine which signals will be routed through the filter:

Bit 0: When this is set to zero, voice 1 appears directly at the audio output, and there is no filtering effect. When set to 1, voice 1 is processed through the filter, and the harmonic content of voice 1 is altered according to the selected filter parameters.

Bit 1: Ditto for voice 2.

Bit 2: Ditto for voice 3.

Bit 3: Ditto for external audio input on pin 26.

Mode/Vol — Register \$18 (54296)

Usually referred to as the master volume control, this actually does a whole lot more.

Bits 0 to 3 are the actual volume settings, and allow you to select an overall volume ranging from 0 (silence) to 15 (maximum).

Bits 4 to 7 select various filter modes and output options:

Bit 4: When set to a '1', the low pass output of the filter is selected and sent to the audio output. For a given filter input signal, all components of the frequency below the filter cut-off are passed through unaltered, whilst all those above the cut-off are attenuated at a rate of 12 decibels per octave.

Bit 5: As above for band pass output, but attenuation above and below the cut-off is at a rate of 6 decibels per octave.

Bit 6: As above for high pass output, and attenuation below the cut-off is back to 12 decibels per octave.

Bit 7: When this is set to '1' the output of voice 3 is disconnected from the direct audio path, so setting voice 3 to bypass the filter and setting 3 OFF to a '1' stops voice 3 from reaching the audio output. Thus voice 3 can be used for modulation purposes without any extraneous noises coming out.

These filter modes are additive, in that one can combine a number of different modes at the same time. Playing with, and understanding, these frequency alterations is the key to getting the most out of the 6581.

I have not given you any concrete examples here, so you'll just have to sit down and do it for yourself. But, armed with the above information about how the important registers can be altered for filtering, synchronisation, and other techniques, the 6581 Sid chip should begin to reveal just a few of its secrets to you. ■

Cuthbert Goes Walkabout

Cuthbert is on the Lunar Landing Pad, waiting for the Federal Chief's State Visit. He must turn the lights on by walking across the switches, located at the corners of the squares, before the invading Moronians get him. Watch him do his Victory Dance before he tackles the next "Pad" and another, larger, set of Moronian Invaders. Can you get your name in the Hall of Fame?

Superb full colour graphics with accompanying music.

All Cassettes
£8 each

(Includes VAT & Postage)

AVAILABLE FROM
DRAGON 32
DEALERS
NATIONWIDE
OR ORDER DIRECT
FROM:

MICRODEAL

41 Truro Road St. Austell
Cornwall PL25 5JE
Tel: 0726 67676

AVAILABLE FROM
and  **John Menzies**
SHOPS

Send 1st class stamp for FREE Software Lists for Dragon and Tandy range of computers.



"ADVENTURES INTO

AVAILABLE FROM W.H. SMITH
AND ALL LEADING CO

Transylvanian Tower

A spine chilling adventure...
enter via the dungeons...
navigate your way through
500 3-D rooms... survive
the swooping vampire bats
... reach the terrifying top...
confront and kill Count
Kreepie, ridding the world
of this Transylvanian Terror.
Can you survive the Top of
the Tower? Full save routine
for use during the hours of
darkness! 48K Spectrum
£6.50

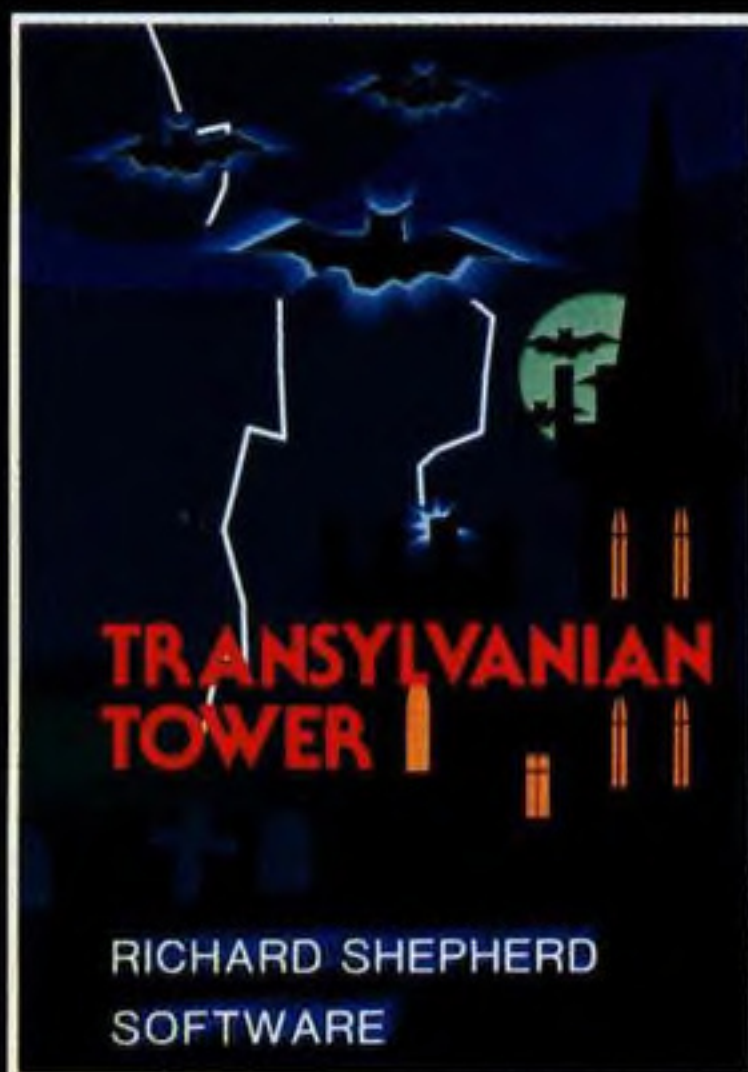

Super Spy

Locate the secret island
hideaway of the mysterious
meglomaniac Dr. Death.
Follow his trail across
continents, through
complex puzzles and 3-D
mazes. Discover the
entrance to his under-
ground lair — but beware
— even with your death-
defying gadgets his evil
henchmen may still win the
day!
With save routine for part
time secret agents! 48K
Spectrum £6.50



Devils of the Deep

Can you discover the fabled treasures
by lethal crabs and menacing electric eels
secrets of the Lost City as you wander
ancient columns. Explore the hundred
the treacherous seabed, each with its
dangers.
Sensational 3-D graphics used as you've
before! 48 K Spectrum £6.50. Full save

RICHARD SHEPHERD
SOFTWARE

DEALERS — GENEROUS DISCOUNTS AVAILABLE CONTACT

RICHARD SHEPHERD SOFTWARE

ELM HOUSE, 23-25 ELM SHOTT LANE, CIPPENHAM, SLOUGH, BERKSHIRE.

CREDIT CARD H
RING (06286) C
FOR EXPRESS S

INTO IMAGINATION!!

INTO IMAGINATION"

RICHARD SHEPHERD, JOHN MENZIES, BOOTS*

ALL MAJOR COMPUTER STORES

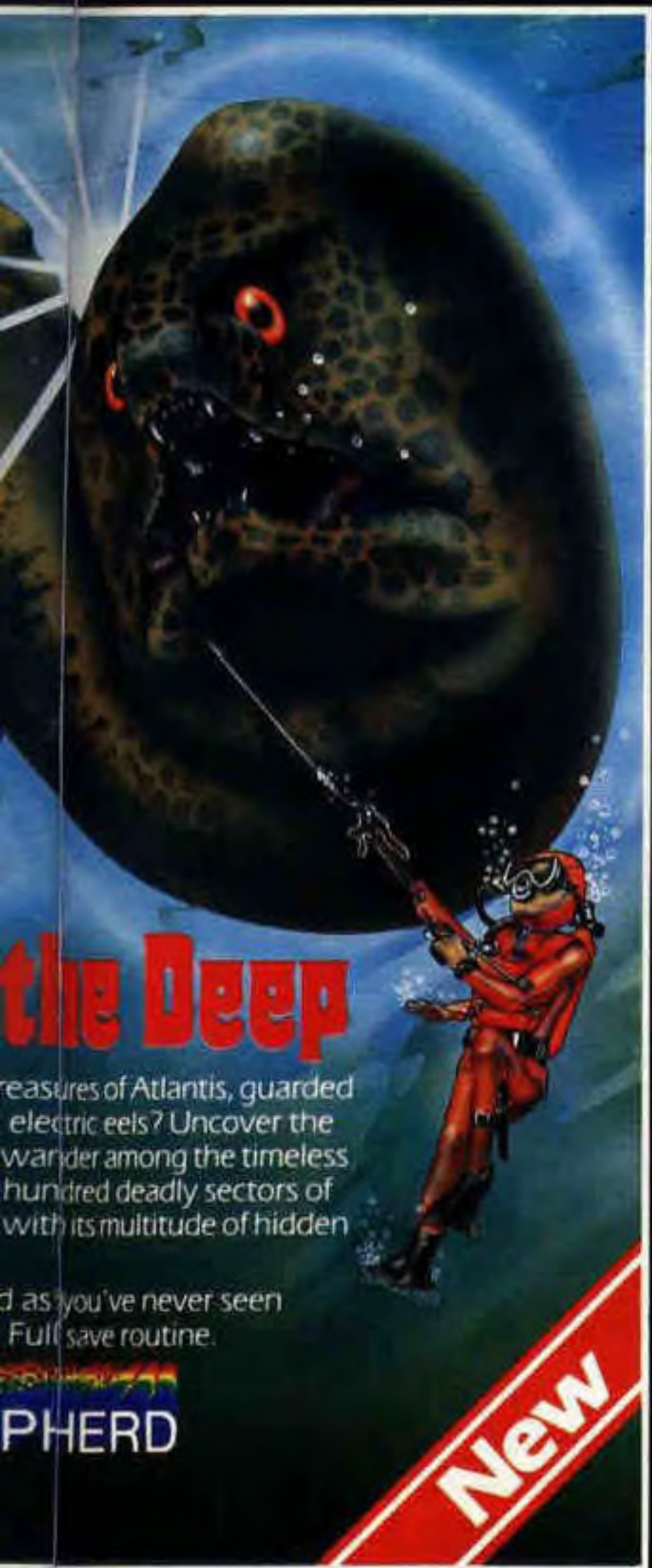

The Deep

Treasures of Atlantis, guarded by electric eels? Uncover the secrets and wander among the timeless, hazardous and hundred deadly sectors of Atlantis with its multitude of hidden treasures as you've never seen before. Full save routine.

RICHARD SHEPHERD

New



New

Invincible Island

RICHARD SHEPHERD
SOFTWARE

Invincible Island by Peter Cooke

Exhaust your ingenuity in the quest to find The Seven Parchments of Xaro and their meaning! Will they lead you to undreamt of treasures or eternal doom? Explore the mysteries of the stockade and puzzle within the Pagoda! A spectacular split screen graphic and text adventure to braintease you for weeks!

Adventurous graphics for every location. Save routine. 48K Spectrum **£6.50.**

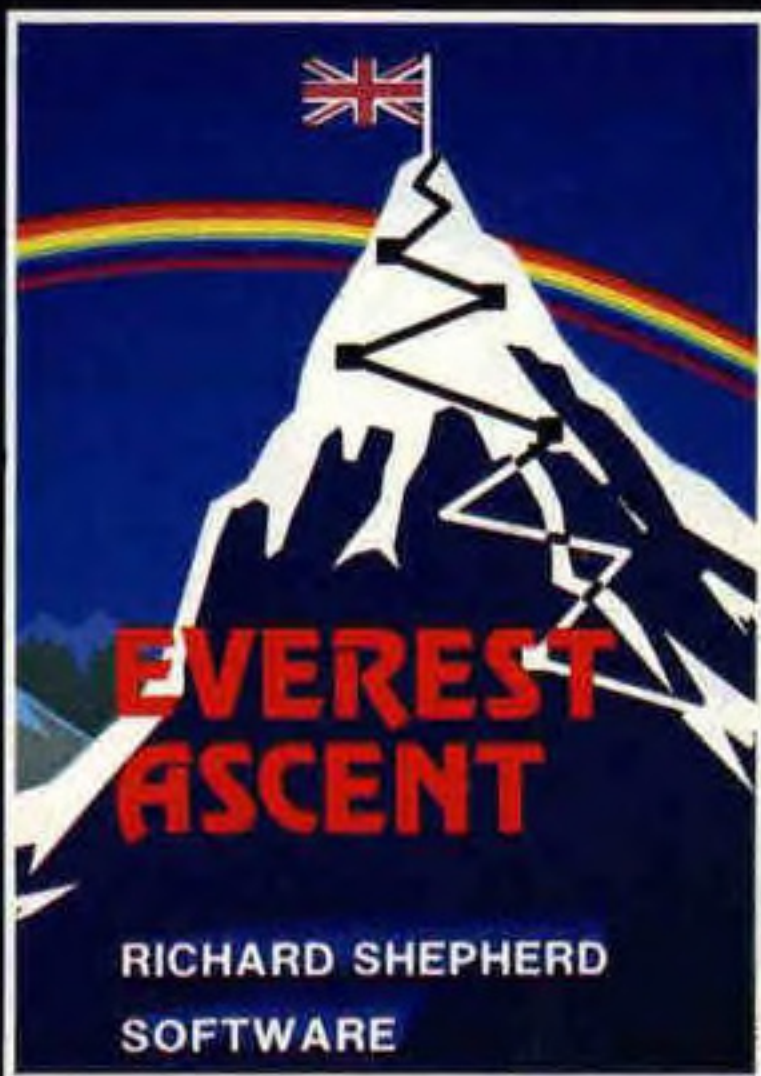

EVEREST ASCENT

RICHARD SHEPHERD
SOFTWARE

Everest Ascent

Stake your claim to the top of the world in this strategic vertical adventure. Conquer the summit of the world's highest peak! . . . struggle from base camp to base camp . . . survive the elements . . . watch out for avalanches, thin ice and wayward sherpas . . . encounter abominable snowmen and cross bottomless crevasses!

A game of skill, strategy and planning — a graphic simulation of man's ultimate endeavour! Save routine. 48K Spectrum **£6.50.**

CONTACT JOHN SALTHOUSE ON (06286) 63531 FOR DETAILS

**CALL HOTLINE
(06286) 63531
PRESS SERVICE**

RICHARD SHEPHERD SOFTWARE

ELM HOUSE, 23-25 ELM SHOTT LANE, CIPPENHAM, SLOUGH, BERKSHIRE.

Games

GSH
Guild of Software Heroes

THE AMAZING ADVENTURES OF THE LAUGHING SHARK PART THREE

PENG

FEELING PECKISH, HE WAS TEMPTED BY A MOUTH-WATERING SNACK DANGLING BEFORE HIM. BEWARE MIRTHFUL HERO.....

MMM!! A MACWIMP CRAB-BURGER

THE LAUGHING SHARK, TIRED OF WET WINDY AND BLACKED-OUT PENGE, HEADED FOR SUNNY CLIMES.....

IT'S ANGLER AFTER A BITE!

A FLYING SHARK !!!???

WRONG AGAIN!! IT'S RIDER PARACHUTING HIS WAY TO A TOP SECRET MISSION TO CHECK OUT MINED ROADS-FIRST HAVING TO LAND ASTRIDE A MOTORBIKE

BETTER NOT DISTRACT HIM! ANY MISTAKES COULD PROVE PAINFUL-EVEN FATAL.....

GERONIMO

NO OLD BOY, THE LAUGHING SHARK ACTUALLY.

AW NUTS!!

FROM HIS TRUSTY TRAWLER, ANGLER NEARLY HOOKED OUR HERO, WHO DECIDED IT WOULD BE SAFER IN THE AIR.....

LATER..

AN EXPLOSIVE SITUATION!

OUR HERO WOULD BE BETTER OFF CATCHING THE VIRGIN BUS CHECKING OUT ALL THE FAB NEW GAMES.

TICK TOCK

ROAD CLOSED UNEXPLODED BOMB

OH NO! A UXB!! UNLESS THE BOMB DISPOSAL EXPERT CAN FIND THE RIGHT TOOLS TO DIFUSE IT, OUR FISHY FRIEND COULD BECOME SHARK PASTE!!

HIGH OVER METROPOLIS DISASTER HAS STRUCK. A NEW BUILDING HAS COLLAPSED AND SCAFFOLDING SID'S ONLY HOPE IS TO PLANKWALK TO SAFETY-BUT WATCH OUT FOR MONSTERS!!

LIFE IN THE AIR IS A LITTLE TOO EXCITING.

WATCH OUT for the **VIRGIN GAMES FUN BUS** – on tour **NOW**



Angler
by Dirk Olivier
Spectrum 48K
VGC 1012
Fishy fun for all ages – but don't catch a crab!



Rider
by Roy Poole & Terry Murray
Spectrum 48K
VGC 1014
Parachute into the enemy territory and ride the mined roads.



Plankwalk
by Neil Cannon
BBC B
VGA 2008
Can you help scaffolding Sid to stay alive!



UXB
by Patrick Fisher
Dragon 32
VGB 4004
A nail-biting test of skill and nerves to defuse the unexploded bomb.



Noc-A-Bloc
by Richard Bygrave
BBC B
VGA 2010
Just when you thought it was safe to go back in the deep freeze!
Joystick/Key



Ghost Town
by John Pickford
Spectrum 48K
VGC 1013
An intriguing graphical adventure

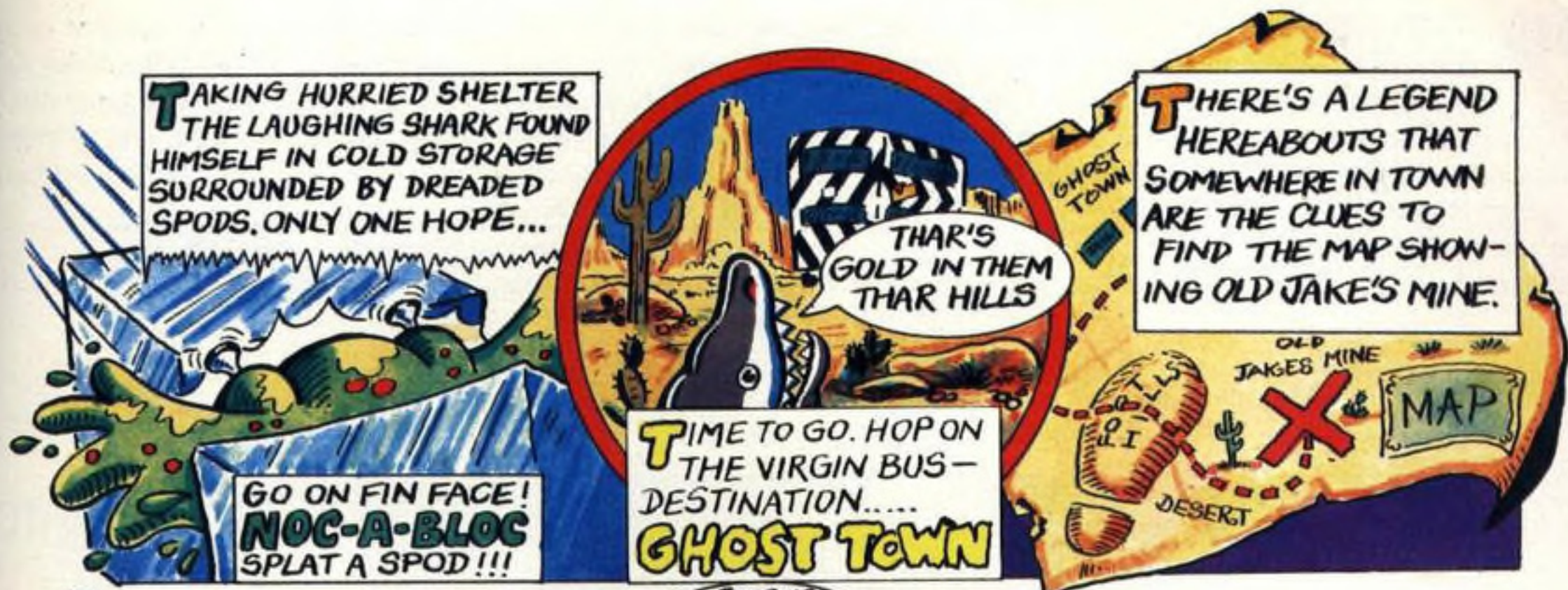

MAIL ORDER

All our programs are available at normal retail price including postage and packing direct from our "MY LOCAL DEALER STILL DOESN'T STOCK YOUR PROGRAMS DESPITE THE FACT THAT THEY'RE REALLY GOOD DEPARTMENT" at 61-63 Portobello Road, London W11.

COLOUR CATALOGUE

If you want a copy of our sixteen page colour catalogue FREE listing details of all our games, please write to the "GIMMEE A CATALOGUE QUICK JIMMEE



Cruncher
by Malcolm Ripley
BBC B
VGA 2009
Trample the time-bombs, but avoid the boots or be 'crunched'.
Joystick/Key



The Island
by Martyn Davies
Spectrum 48K
VGC 1015
Find the treasure - a full 48K adventure with action sequences.

"DEPARTMENT" enclosing an A4 SAE (with 17p stamp).

THE "I WANT TO BE RICH AND FAMOUS DEPARTMENT"

We are always keen to receive any original entertaining programs with good graphics at our now famous "I WANT TO BE RICH AND FAMOUS DEPARTMENT" from any of you programming mega-stars out there. Don't delay - send today!

VIRGIN GAMES GANG

Our GANG is growing in numbers all the time, and everybody who buys one of our NEW GAMES will RECEIVE:

- a year's FREE MEMBERSHIP of the GAMES GANG;
- FREE ENTRY in the next VIRGIN GAMES GANG DRAW;
- 6 FIRST PRIZES, consisting of a VIRGIN DAY OUT - a trip on the VIRGIN GAMES FUN BUS to the VIRGIN MANOR RECORDING STUDIO in Oxfordshire. And then be our guest at the famous KENSINGTON ROOFTOP NIGHTCLUB, "THE GARDENS";
- 50 SECOND PRIZES of VIRGIN GAMES POSTERS.
- 100 THIRD PRIZES of VIRGIN GAMES POSTERS.

VIRGIN GAMES ARE:

Vic 20	MISSION MERCURY	£7.95
Vic 20	ENVAHI 8K	£5.95
Vic 20	CREEPERS 3/8K	£5.95
Spectrum	YOMP 16/48K	£7.95
Spectrum	STARFIRE 48K	£7.95
Spectrum	SHEEPWALK 48K	£7.95
Spectrum	GOLF 16/48K	£7.95
Spectrum	LOJIX 48K	£5.95
Spectrum	RACING MANAGER 48K	£5.95
Spectrum	QUETZALCOATL 48K	£5.95
Spectrum	ROBBER 48K	£5.95
Spectrum	SPECTRON 48K	£5.95
Spectrum	LOST 48K	£5.95
Spectrum	THE ISLAND 48K	£5.95
Spectrum	GHOST TOWN 48K	£5.95
Spectrum	RIDER 16/48K	£5.95
Spectrum	KILLER CAVERNS 16/48K	£6.95
Oric	DEATH CRUISE	£6.95
Dragon	I CHING	£6.95
Dragon	CASTLE ADVENTURE	£6.95
Dragon	UXB	£6.95
Dragon	FALCON PATROL	£6.95
COMMODORE 64	BITMANIA	£6.95
COMMODORE 64	BUG BOMB	£7.95
BBC B	LANDFALL	£7.95
BBC B	SPACE ADVENTURE	£7.95
BBC B	TRENCH	£7.95
BBC B	'OWZAT	£7.95
BBC B	CHIEFTAIN	£7.95
BBC B	MICROBE	£7.95
BBC B	PLANKWALK	£7.95
BBC B	CRUNCHER	£7.95
BBC B	NOC-A-BLOCK	£7.95
T199/4A	ROBOPODS	£6.95
T199/4A	FUN-PAC	£6.95

WHEN YOU BUY FORTH MAKE IT THE BEST!

“Forth is closer to machine code and more than 10 times faster than BASIC. A game of Space Invaders written using it would be almost as if it is written in machine code.” Sinclair User. ● “Abersoft Forth has no known bugs, gives you more Forth words, and because it allows 12 screens in memory at once it is easier to load and save programs.” Personal Computer News. ● “Abersoft Forth is a complete version of the language with added colour, attribute and graphics instructions. It is also possible to define your own characters just as you can in Spectrum BASIC.” s.u. ● “Forth is an easy language to use, and the graphics commands in Abersoft Forth allow you to do anything in Forth that you can do in BASIC.” P.C.N. ● “Abersoft Forth is the only Spectrum package which has been endorsed by the Forth Interest Group.” s.u. ● “Its features make it well worth the price.” P.C.N. ●



FANTASTIC



MELBOURNE HOUSE



Melbourne House Publishers

SPECTRUM Books

- Understanding Your Spectrum **NEW LOW PRICE** £6.95
- Spectrum Machine Language for the Absolute Beginner **NEW LOW PRICE** £5.95
- Over The Spectrum **NEW LOW PRICE** £4.95
- The Complete Spectrum ROM Disassembly £9.95
- Spectrum Hardware Manual £5.95
- Spectrum Microdrive Book £5.95
- Supercharge Your Spectrum £5.95
- Please send me your free 48 page catalogue

48K Spectrum Cassettes

- Penetrator £6.95
- The Hobbit £14.95
- Terror-Daktil 4D £6.95
- Melbourne Draw £8.95
- H.U.R.G. £14.95
- Computer Bridge £8.95
- Abersoft Forth £14.95

I enclose my cheque/money order for £ _____

Please debit my Access Card No. _____ Expiry Date _____

Signature _____

Name _____

Address _____

Postcode _____

All prices include VAT where applicable. Please add 80p for post and pack.

£ _____

£ + p/p .80 _____

Total _____

£ _____

Orders to:
Melbourne House
131 Trafalgar Road
Greenwich, London SE10

Correspondence to:
Melbourne House
Church Yard
Tring, Hertfordshire HP23 5LU

Trade enquiries welcome POP 1/12

All Melbourne House cassette software is unconditionally guaranteed against malfunction.

Access orders can be telephoned through on our 24 hr ansafone (01) 858 7397.



AGF

PROGRAMMABLE JOYSTICK INTERFACE

MICRODRIVE
COMPATIBLE

for
Spectrum
or **ZX81**



ABOUT OUR INTERFACE

The AGF Programmable Joystick Interface is a unique design offering the use of any Atari-compatible joystick with absolutely all software, whether it is cassette or ROM cartridge, with the Sinclair Spectrum or ZX81.

The hardware programmable interface requires no additional software and accurately replicates the keys of the computer in a manner which is responsive to absolutely ALL key reading methods, both BASIC and Machine Code.

The interface does not interfere with key operation and can therefore be used simultaneously with the keyboard.

There is no need to remove the interface once fitted as the rear extension connector will accommodate further expansion, i.e. printers or RAM packs etc. This important feature avoids excessive wear to the expansion port.

The key replication principle pioneered by AGF means that your own programs can use eight directional joystick movement by utilising simple key reading BASIC.

Two joystick sockets are provided which share the same keys, for use with the majority of two player games. Several interfaces may be used on the same computer for multiple joystick applications.

The interface is programmed by a two digit code, which is looked up on a programming chart supplied, for each direction and firing button. The two numbers are then selected on a pair of leads which are clipped onto appropriately numbered strips on the interface.

Once configured this can be marked on a Quick Reference Programming Card for storing with the game. As the programming is *not* power dependent the interface retains the last configuration made and can be immediately used when next switched on.

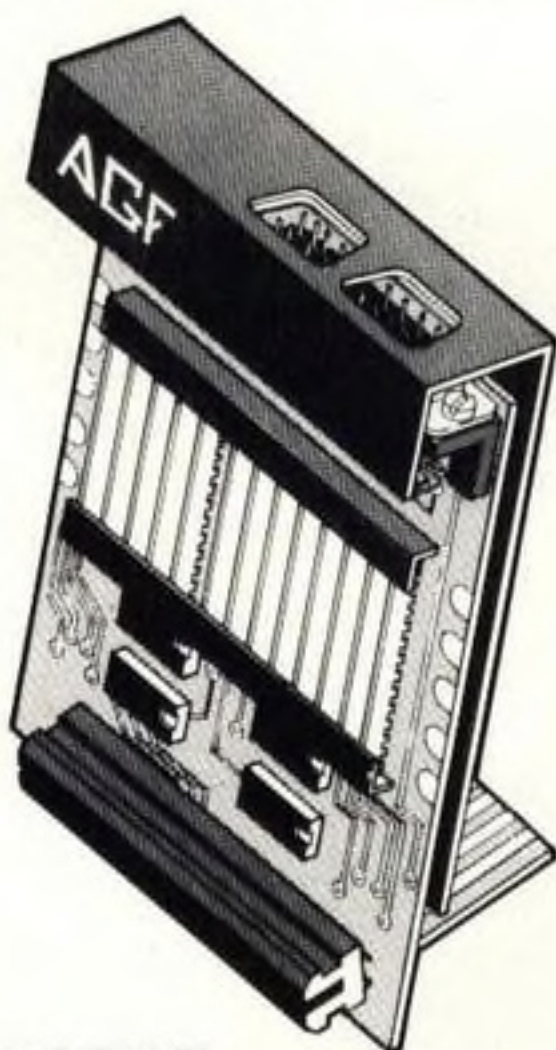

KEY FEATURES

- * Programmable design gives TOTAL software support.
- * Accepts Atari, Competition Pro, Wico, Starfighter, Quick Shot, Le Stick etc.
- * Rear extension connector for all other add-ons.
- * Free demo program and instructions.

PACKAGE CONTENTS SUPPLIED

- Programmable Interface Module as illustrated, complete with clip-on programming leads.
- Self adhesive programming chart detailing how to define which key is simulated by UP, DOWN, LEFT, RIGHT, and FIRE. This can be fixed on to the case of your computer or if preferred the protective backing can be left on. The chart is made of a very durable reverse printed plastic and is extremely easy to read.
- One pack of ten Quick Reference Programming Cards for at-a-glance setting to your games requirements. The card allows you to mark the configuration in an easy to read fashion with space to record the software title and company name.
- Video Graffiti demonstration program which is written totally in BASIC to illustrate how all eight directions and fire can be read. This is also a useful high resolution drawing program.
- 12 months guarantee and full written instructions.

JOYSTICKS

CONTROLLERS

FOR USE WITH OUR INTERFACE
Module or VIC 20, Commodore 64,
Atari VCS, Atari 400, Atari 800

If you require extra Joysticks for our
original interface module mark order
'OLD' Joysticks

ONLY £7.54 inc VAT + P&P

FROM: MR/MRS/MISS

ADDRESS

SEND C.W.O. (NO STAMP NEEDED) TO: A.G.F. HARDWARE, DEPT. **PW**,

FREEPOST, BOGNOR REGIS, WEST SUSSEX, PO22 9BR

QTY	ITEM	ITEM PRICE	TOTAL
	PROGRAMMABLE INTERFACE	33.95	
	JOYSTICK(S)	7.54	
	PACK(S) QUICK REFERENCE CARDS	1.00	
ONE	VIDEO GRAFFITI	FREE	
		FINAL TOTAL	

ZX81 ZX SPECTRUM Please tick
DEALER ENQUIRIES WELCOME EXPORT PRICES ON APPLICATION



MOGUL

THE HOTWARE PEOPLE

METAMORPHOSIS

VIC 20 · COMMODORE 64

You have stumbled into the nest of the Cyglorx and find yourself fighting off the Robot Tanks!

£7.95

KONGO KONG

VIC 20 · COMMODORE 64

Climb ladders, avoid the barrels thrown by the Crazy Ape—rescue the Damsel.

£6.95

ZEUS

COMMODORE 64

Your Cone of Cold protects you as you become the Wizard fighting off the Thunderbolts of the angry god—Zeus.

£6.95

EARTHQUAKE

VIC 20 · COMMODORE 64

A great adventure, you are in a shopping centre during an earthquake. To save yourself you must first help the others!

£6.95

CREATORS REVENGE

COMMODORE 64

Penetrate the depths of Robot City and kill the Creator. Destroy the robots—but watch out for new robots as they hatch!

£7.95

SUPER TREK

VIC 20 · COMMODORE 64 · ORIC

Commanding the bridge of your Starship, you explore the Galaxy. Fend off the Klingon attacks with your Phasers.

£6.95

ANNIHILATOR

VIC 20 · COMMODORE 64

Defend your Planet against Invading Aliens. All machine code makes for fast and furious arcade action!

£5.99

PYRAMID

VIC 20 · COMMODORE 64

TI99/4A

A really tough adventure game as you try to ransack the Pyramid. However the builders have left clues everywhere.

£6.95

POLLYWOG

VIC 20

Hop your Pollywog across danger to the safety of his home.

£6.95

ANNIHILATOR 2

COMMODORE 64

Another Great Game from the author of Annihilator and Metamorphosis—Mike Wacker.

£7.95

GREAT ADVENTURE PACK

VIC 20 · COMMODORE 64

Three Great Adventures in One Package. African Escape, Hospital Adventure, Bomb Threat. Great Action, Great Value, Great Fun.

£6.95

PLUS

Four Great Games for the Spectrum 48K

POTTY PLANTER · ADDER ATTACK · LAS VEGAS LADY · CRASH

All at **£5.50**

**AVAILABLE FROM ALL GOOD DEALERS
TRADE ENQUIRIES WELCOME**

MOGUL COMMUNICATIONS LIMITED · 90 REGENT STREET · LONDON W1R 5PT
Telephone 01-437 3156/7

LWS

VIC20 CBM64 OWNERS!!!

BUY DIRECT FROM THE MANUFACTURERS AND SAVE POUNDS!!!
4 SLOT SWITCHABLE MOTHERBOARDS, VIC20 £18.95 * * * CBM64 £19.50

VIC20 RAM PACK ADAPTOR CARTRIDGES

Run 3.5K software on your expanded system without removing the Ram pack! A real must for the games player, many hundreds already sold..... £12.45

NEW NEW NEW ROBOT DRIVE INTERFACE

Plugs into the Vics or 64S user port and gives complete computer control of DC motors. Contains all the circuitry for stop start and reverse. Comes complete with software cassette giving full instructions and control program..... £18.95

COMING SOON WANT TO BUILD A DROID?

We are currently testing a large range of robot components that can be assembled in many different forms, ie, swivelling base units motorised arms gripper units, DC motor and gearbox drive units with optical encoders and much, much more!!!
All prices inclusive of VAT and P&P.

L. W. STAINES & CO, UNIT 2 RADING TRADING ESTATE
LONDON ROAD, BARKING, ESSEX IG11 8BU
Tel: 01-591 2900

NOW!! DELTAS FOR DRAGONS



The smooth control of a Voltmace DELTA sprung return joystick is now available to Dragon owners. Called the DELTA 3D it is a cut down version of our DELTA 14B handset. The same robust ball and socket jointed joystick but with the keypad blanked off to leave a choice of one of three fire buttons.

DELTA 3D joystick £10.00 each
or £19.50 per pair

Seven-day money back guarantee if not satisfied
Price includes p&p and VAT

VOLTMACE LTD, PARK DRIVE, BALDOCK, HERTS
TEL: 0462 894410

Made in England. Callers welcome
at the factory — Monday to Friday.
Trade terms available.

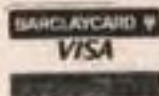

BBC model B

CASSETTE 10 is a new collection of ten great educational games.

- *Special 'INDEX' program
- *7-11 age group
- *Free and fast delivery
- *Free booklet
- *Excellent value at only £11-85 inclusive

Send cheque (payable to Schoolsoft) to:
Schoolsoft (Dept. 8), 62 Middle Lane,
Kings Norton, Birmingham B38 0DY.

Trade enquiries welcomed.

E.C.B. DRAGON OWNERS

Screen Dump now available for Tandy CGP115
Colour Printer
P MODES 0-4. SCREEN 1.0 1.1
Two sizes and three or four colour options, full
machine code

£10.00 per tape inc. p&p

Send cheque/PO to:

E.C.B.
49 BEECHMOUNT AVENUE, HANWELL
LONDON W7 3AE

THE DESKTRI

WORK STATION

INC. VAT
&
POSTAGE

£44.95



Connector gives neat & centralized power location

SPECIAL FEATURES:

- Custom Designed and produced for the Home Computerist.
- Accommodates most popular makes of computer PLUS Tape and Disk Drive Units and Printer.
- Multi-Block electrical connector.
- Elegant Teak-Effect finish with robust, steel frame.
- Easy-Glide castors.
- Supplied as EASY-ASSEMBLE Flat-Pack with full instructions.

OVERALL DIMENSIONS:
34" H. x 31" L. x 18" D.

TERMS OF OFFER Allow up to 28 days for delivery.
UK Mainland only. Cheque/P.O. with order, to DESKTRI LTD.

Please rush me a Desktri Work Station NOW!
I enclose my cheque/P.O. No. for £44.95
PLEASE PRINT

Name

Address

DESKTRI LIMITED

114 Southchurch Road, Southend-on-Sea, Essex SS1 2LX
Tel: (0702) 619494

A crowded market

Andrew Pennell takes his Sord in both hands and enters the cut and thrust world of the under-£200 computer market

The CGL M5 is yet another contender in the crowded sub-£200 computer market. It is manufactured by Sord in Japan and sold in this country by CGL, known for their *Game & Match* toys.

The standard M5 machine costs £149.95, and comes with 20K Ram and 16K Rom. This is not as attractive as it first seems as 16K of the Ram is dedicated to the video display, leaving only 4K for the user. Of the Rom, 8K is contained in the machine as the operating system, while a further 8K is supplied in the Basic-I plug-in cartridge. Supplying the main language on a detachable cartridge is a very good idea, as it can be changed or upgraded. Something which may be rather necessary on the M5.

The main unit is little larger than the Spectrum, though rather heavier. It is in pleasant two-tone colours, with a detachable flap that occupies the rear third of the top. The flap has to be removed when the machine is in use, as it covers the cartridge slot. The cartridges themselves are exactly the same size as cassette boxes, and they fitted into my cassette rack perfectly. The keyboard is one of the popular (with manufacturers anyway) moving-rubber key types, but is much nicer to type on than the Spectrum. Each key is shaped as a square with a corner removed, for some inexplicable reason, and there are even 55 keys, removing the need for the complicated shifts required on the Spectrum's 40 keys. Unfortunately there is no space bar, and the space key is just under the *Return* key, which is not really a good place for it. It also has two *Shift* keys, a *Ctrl* key, a *Func* key (for single-key entry) and a *Reset* key, which sensibly also requires *Ctrl* to be pressed. Each key has the main symbol in white, any keywords in yellow, and graphic symbols in blue. As the keys themselves are also blue, it makes the graphics all but invisible under

concealed under a considerable weight of metal shielding which really does cut down on radio interference — Sinclair please note. Among the components are the Z80A microprocessor, the Texas 9929 video chip, a Z80 CTC timer chip, a 76489 sound chip, and an 8K *Rom*. The CGL M5 uses the same video chip as that in the now defunct TI 99/4A, the new Memotech MTX500 (see *Popular Computing Weekly*, November 17), and the forthcoming MSX-standard series machines. The sound chip is the same as that used by the BBC micro and the Memotech.

Because of its apparent similarities with the Memotech, I was very interested in the display quality on the M5. The machine initialises to white letters on a black background, and appears twice on the tv dial — there was no discernible difference between the two. Unlike the Memotech, all the characters were visible on the screen, but it was similar in the way the picture distorts 'CinemaScope' fashion, so that circles are oval in shape. Colour stability was better than the Memotech, and the sound quality very much better.

The M5 is supplied with the Basic-I *Rom* cartridge which CGL say is Easy BASIC for Beginners. I can only presume that the I in the name means in fact Basic for Idiots!

The first thing I did with the computer was to type in a three-line program to print the character set and it would not run. After Listing it I found that the word *Let* had been inserted before each statement. After examining the manual I discovered that if a space is not entered after each line number then *Let* is inserted — it is claimed that this is done so that you do not have to type *Let*, but it seems ridiculous to me. Spaces are also required to separate commands, else they are not accepted. Normally commands have to be typed in letter by letter, but if the *Func* key is held down with

characters can be accessed direct from the keyboard, though the manual has to be referred to as half the legends are missing and the other half are illegible due to the colour clash of the keys and keyboard already mentioned. Control codes can also be entered in listings, by holding *Shift*, *Ctrl* and the appropriate key, and they get listed as inverse characters. The codes are important since they control the different screen modes.

The Basic itself is rather unusual in that it is integer-only. This means that no decimals are allowed, and numbers are limited to the range ± 32767 . The last micro I can remember that was integer-only was the Acorn Atom some years ago. After thinking about it though, for a beginner, integer-only is probably sufficient. The best part of Basic-I is its speed — it is incredibly fast. Simple tests showed it to be at least four times faster than the Spectrum, and marginally faster than the BBC! Its speed is obviously due to the integer limitation. The commands are fairly standard, with some additions for graphics.

The M5 has four graphics modes. The simplest is Text, which is 40 x 24 characters in two colours. Graphics Mode 1 has a resolution of 256 x 192 pixels, but only a maximum of 256 characters can be displayed, each with a foreground and background colour chosen from a palette of 16 colours. Graphics Mode 2, the most useful, has the same resolution, but the screen is fully bit-mapped in colour giving a colour resolution of 64 x 192. Finally, multi-colour mode, in which each pixel can be any of 16 colours, has a resolution of only 64 x 48 and is really not at all useful.

The best feature of the Texas 9929 chip, and thus the M5, is its ability to display and control large graphics shapes — Sprites. All of the above modes, except Text, can support up to 32 Sprites each of size up to 32 x 32 pixels which are independent of the graphics screen, and can be one of 16 colours.

Basic-I has only a few commands for accessing the graphics, and none are explained in detail or at all clearly in the manual. To switch between graphic modes, certain control codes have to be printed, and this is certain to confuse the beginner. If for some reason an error occurs in some of the modes, the error message will be invisible, and the computer appears not to be working. This is particularly a problem in Multi-colour or Graphics 2 modes, as characters are not printed sensibly in either. The manual unwisely advises that the power be removed if the screen displays meaningless characters, but this is simply not so. Eventually, after pressing complicated *Ctrl* sequences, control can be regained.

Once in a particular graphic mode there are a handful of commands to define the shape, colour, size and position of the Sprites, but their use is poorly explained in the manual's Appendix. There are no



normal light.

Along the back of the case are the power and cassette sockets, a Centronics printer socket, two joystick sockets, tv output, and video and audio outputs. Regrettably, the joystick sockets are non-standard, so only the CGL 'joypads' will fit. This is a problem since they are not very good.

The power supply is a huge black slab that has to sit next to the main unit because of its short lead — aesthetically pleasing it is not, but, thankfully, it is silent.

Inside the case there is only one circuit board containing the electronics. It is well

certain letters a whole keyword is generated. This single-keyword entry is optional but, again, if you don't press *Space* after each keyword the line will not run.

Lines are edited using a fairly standard screen editor, using the cursor keys in conjunction with *Ctrl*. Insert mode can be entered with *Ctrl P*, and left with *Ctrl O*. Delete works — in the opposite way to the norm — removing the character to the right of the cursor — but this seems to be getting more popular and one soon gets used to it. Program lines can be entered in either upper or lower-case and are listed in upper-case. A wide range of graphics

commands to plot points or draw lines, or to use the sound chip.

This would not be a great problem if CGL provided sufficient technical information to allow access by *Pokes*, *VPokes* (for the video Ram) and *Outs*, like Commodore do, but no mention is made. I was most unimpressed with the CGL M5 until I typed in a demonstration program from the back of the manual. It produced a rather impressive game in colour with Sprites and background characters. The listing was full of *Pokes* and other such commands, but no explanation of them was given. It also showed how to use the sound chip using an *Out* instruction but, again, no details

For *Next* loops. There is a limitation, not mentioned in the manual — only four Sprites can be on a given horizontal line. That information I discovered in the Memotech manual. The *Joint* statement allows Sprites to be joined together to make bigger shapes. To detect collisions between Sprites, there is a command *On Coinc Gosub xxx*, and if any two Sprites touch each other then routine *xxx* is executed. These graphic commands make it simple to write complicated games and they run fast, too.

As well as the extra graphics commands, Basic-G also supports the sound chip. On the M5 the sound output is through the tv speaker and it is nice and

clear. The commands for using it are *Play*, for music, and *Sg*, for sound effects. The M5 has three tone channels and one noise channel — all easily used Basic-G. The *Play* command is used in a similar way to that on the Dragon 32, but can address all three channels. It is not just the note that can be controlled. So can the octave, duration, volume, tempo and envelope. The control commands are all clearly ex-

matrix printer that has a bit-mode with 8 dots, such as the Epson machines. It would appear, however, to rule out the popular Seikosha GP100. Although Basic-G has a large number of good features, it still has the idiosyncrasies of Basic-I. Spaces are still required in lines (except after line numbers), error messages are still just numbers and, incredibly, it is still integer-only.

Just before writing this review, I received the M5 Technical Manual, which I hoped would cover all the omissions from the Basic manuals. Unfortunately 'Technical Manual' is not really accurate — most of it is just the Appendix from the Basic-G manual. There are a couple of pages devoted to I/O locations, a vague memory map and a circuit diagram, but actual details of the graphics and sound chips are almost non-existent.

In fact, M5 owners who want to know more should try and get a Memotech manual, as it contains all they should need. There is little mention of machine-code in any M5 document, and information is particularly lacking on the system variables and where to put the code in memory. For independent support a machine needs to have certain technical information available, as Texas found to their cost, and CGL don't seem able to supply nearly enough.

The standard M5 machine with Basic-I and 4K user-Ram seems expensive at £150. I thought only Commodore could get away with omitting the extra commands to use machines (eg, the Commodore 64 and Simons' Basic), but CGL obviously seem to think that they can too.

There is a paragraph in the technical manual that says: 'Basic-I is not designed to bring out all the M5 capabilities. The built-in synthesiser requires much time to produce sounds and the fine colour graphics are difficult to produce on the screen.' I wholeheartedly agree. No such statement appears in CGL's adverts though. With Basic-G and 8K user-Ram it should really be compared with the 16K Spectrum, but costs £185, making the CGL less attractive. However, Basic-G is a brilliant games-writing language (except for the inexcusable lack of floating-point numbers), even though writing similar programs from machine-code is almost impossible with the current level of technical data.

There is supposed to be a 32K Ram pack coming shortly. If CGL were to sell the 32K Ram pack together with Basic-G and the M5 Console at a discount it could make an attractive package.

My feeling is that there are already too many machines competing for the sub-£200 market. CGL will have to change their current tactics if they wish to start the long-heralded Japanese invasion by supplying Basic-G as standard. And that's just for starters. Independent support will be slow in coming without more technical information being easily available. ■

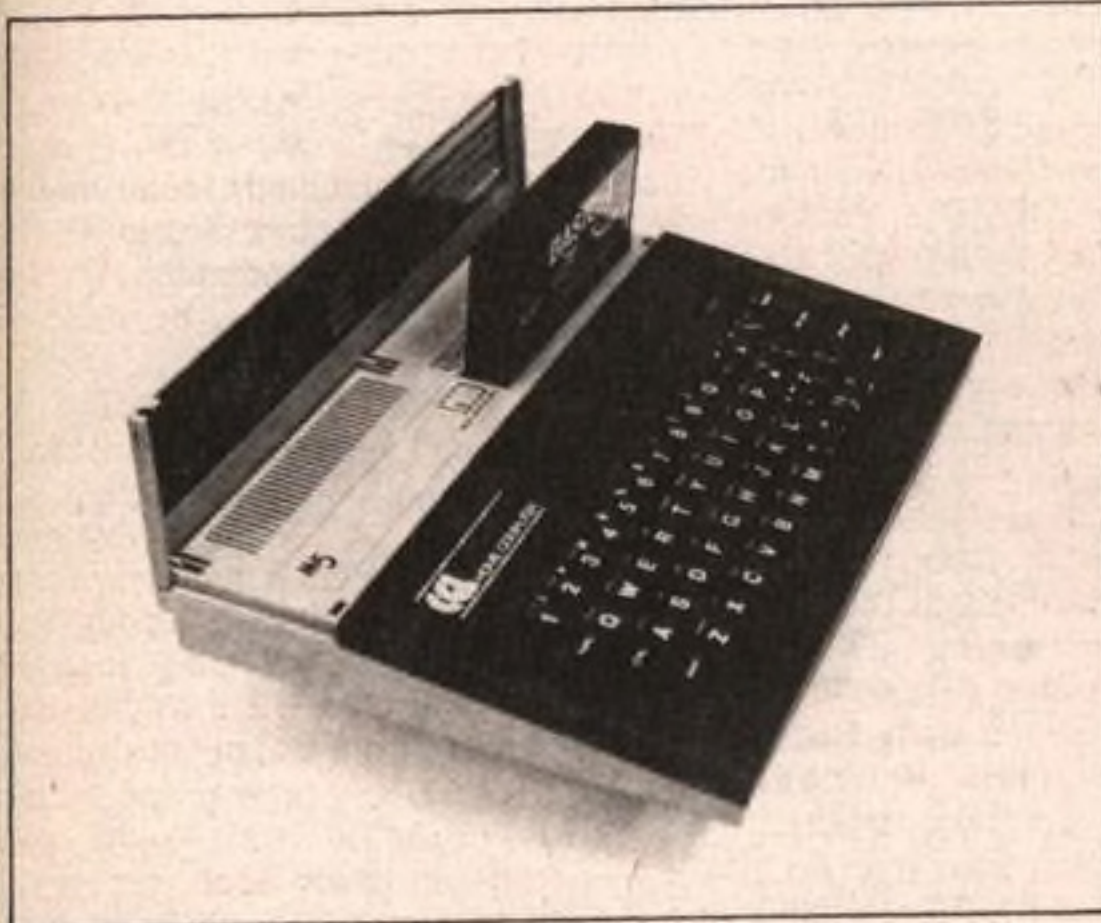

were given. At this stage I realised the CGL had a lot of potential, but I could not get to it.

Then I managed to get hold of a copy of the Basic-G cartridge.

Basic-G, at £34.95, is a cartridge that comes in a huge plastic box, with foam padding to fill it, and a massive 280-page manual. Noticeably heavier than Basic-I, it contains 16K of Rom and an extra 4K of Ram. On the front of the manual are the words 'Easy Basic for Games' and, after examining the contents, it certainly seemed like it.

As well as all the Basic-I commands, Basic-G adds over 50 new ones, mainly for graphics. The graphics modes (except the useless Multi-colour mode) are very well supported, with easy colour commands, pixel plots, line drawings, circles, ovals and even polygons. There is a powerful *Paint* command which is extremely fast and fills in any irregular shape with solid colour. The commands *Bar* and *Box* are given for drawing line and solid rectangles. For controlling the Sprites there are a wealth of commands, the most impressive of which is *Move*: it allows movement to a given point, at a given speed, or movement in a given direction, at a given speed. A maximum of twelve Sprites can be moving together, automatically, at one time, though others can be moved using

plained, even to musical ignoramuses like myself. The *Sg* command can also be used to control the tone generators, but that requires more work.

To aid easy programming, there are several levels of 'interrupts'. Normally these are only available on other machines via machine-code. An interrupt is an occurrence that stops normal program flow for a while, while it does something else; when the extra routine has finished the normal program flow is resumed.

On the M5 there are six types of interrupts controllable from Basic-G. *On Coinc Gosub* has already been mentioned. The others are: *On Event Gosub* and *On Alarm Gosub*, which trigger on certain timed occurrences; *On Key Gosub*, used when a key is pressed; *On Joy Gosub*, when a joystick is moved; and *On Error Gosub*, when any error occurs. This type of interrupt management is a brilliant idea, and deserves to be duplicated on the next generation of home micros.

On the back of the M5 is a socket for a printer cable of the Centronics type. When a printer is connected both listings and text are available by *LList* and *LPrint* commands. Also available is the *PCopy* command which copies the hi-res screen to an attached printer, using parameters set up with the *PMode* command. From what I could see, it should work with any dot-

OPEN FORUM

Open Forum is for you to publish your programs and ideas. Take care that the listings you send in are all bug-free. Your documentation should start with a general description of the program and what it does and then give some detail of how the program is constructed. We will pay the *Program of the Week* double our new fee of £6 for each program published.

Frequency

on Spectrum

This program draws frequency graphs of the sound being received at the ear socket.

First enter the small basic program and save it using the line:

Save "Sound" Line 5

New the computer then enter and *Run* the hex loader program. Use this program to enter the 93 bytes of hex code which constitutes the main program. The hex is the second column of figures starting 110501. When all the code has been entered input "STOP" to stop the program then save the machine code using the line:

Save "Sound" Code 65000,100. New the computer then rewind the tape and

load the basic program. When loaded it will automatically load the machine code and then stop.

The easiest way to use the program is to first record the sound you want analysed onto tape. Run the program and after the tone the computer waits for a signal at the ear socket. Connect the tape recorder as for loading, and play. The computer will store values corresponding to the frequency at location 60000 to 60254.

The program will then draw a simple time versus frequency graph of the values. Press enter to run the program again. Owners of Casio VL-Tones can connect the instrument directly to the ear socket for analysing the waveforms produced by the instruments *Adsr* function.

```

ORG 65000
LOAD 65000
FDE8 110501 LD DE,261
FDEB 216606 LD HL,1636
FDEE CDB503 CALL 949
FDF1 DBFE L1: IN A,(254)
FDF3 FEFF CP 255
FDF5 98FA JR NZ,L1
FDF7 2160EA LD HL,60000
FDF9 06FF LD B,255
FDFC 05 L2: PUSH BC
FDFD 1600 LD D,0
FDFE 06FF LD B,255
FE01 DBFE L3: IN A,(254)
FE03 FEFF CP 255
FE05 2801 JR NZ,L4
FE07 14 INC C
FE08 10F7 L4: DUNZ L3
FE09 72 LD HL,D
FE0B 23 INC HL
FE0C 01 POP BC
FE0D 10ED DUNZ L2
FE0F 00 NOP
FE10 0E02 LD A,D
FE12 CD0116 CALL 0600
FE15 CD6B0D CALL 0405
FE18 0E02 LD A,D
FE1A CD0116 CALL 0600
FE1D 09 EXX
FE1F 09 PUSH HL
FE20 0E00 EXX
FE22 7E00 L5: PUSH A
FE23 47 LD DF,A
FE24 0600 LD B,A
FE26 CDE522 CALL 0600
FE29 2160EA LD HL,60000
FE2C 05 POP BC
FE2E 48 PUSH BC
FE2F 0600 LD D,0
FE31 09 LD B,0
FE32 48 ADD HL,BC
FE33 0E00 LD B,(HL)
FE35 110101 LD DE,257
    
```

```

FE38 CDBA24 CALL 9402
FE3B F1 POP DF
FE3C 0C INC D
FE3D FEFF CP 255
FE3F 20E1 JR NZ,L5
FE41 09 EXX
FE42 E1 POP HL
FE43 09 EXX
FE44 09 RET
    
```

END

>R
HEX LOADER

```

10 DEF FN A$(A)=CHR$(A+43+7*(
A/9))
20 DEF FN B$(A)=FN A$(INT (A/1
6))+FN A$(A-16+INT (A/16))
30 DEF FN C$(A)=FN B$(INT (A/2
56))+FN B$(A-256+INT (A/256))
40 DEF FN A(A$)=CODE A$-43-7*(
A$/"9")
50 DEF FN B(A$)=16+FN A(A$(1))
+FN A(A$(2))
100 LET N=65000: LET D$=""
110 IF D$="" THEN PRINT : PRINT
FN C$(N): " " : INPUT D$
120 POKE N, FN B(D$)
130 PRINT D$(1 TO 2)
140 LET N=N+1: LET D$=D$(1 TO )
150 GO TO 110
    
```

BASIC PROGRAM

```

1 BORDER 1: PAPER 0
2 INK 6: CLS
3 RANDOMIZE USR 65000
4 INPUT A$: GO TO 3
5 LOAD ""CODE
    
```

Frequency
by Chris Eckersley

Screen Block Delete

on Spectrum

This machine code routine is designed to help you clear parts of the screen without damaging another part which you may

want to leave on.

The program will clear any line(s) or column(s) the user specifies. To use the routine do the following *Pokes*

27004 With the first column to clear - 1
27008 With no. of columns to clear
27014 With no. of lines to clear
27016 With specified paper colour

As the programme stands it will *Poke* in the machine code and then *List* the program three times and delete the top left-hand corner of the screen.

This program can be used when, for example, some instructions need to stay on the screen whilst others need not.

```

1 REM *****
2 REM **Screen Block Delete**
3 REM ** By D.Parkinson **
4 REM *****
5
6990 REM *SAVE CODE BY TYPING*
6991 REM SAVE"NAME"CODE 27000,26
6992
9000 FOR 9=27000 TO 27025: READ
a: POKE a, b: NEXT a
9010 DATA 17,32,9,30,235,97,229,
6,16,225,35,229,197,6,12,54,53,2
37,90,16,256,193,16,241,225,201
9020 LIST : LIST : LIST : LET I=
USR 27000
    
```

Screen Block Delete
by D Parkinson

Shoot Out

on Vic20

You are a gunman. When an object appears in front of you, you must shoot as

quickly as you can by pressing Z. After you have shot, your gunman will blow his gun.

Program notes

10-25 Introduction
30-240 Prints man on screen
242-255 Moves object

260-345 Moves bullet and sound effects
500-700 Print man blowing gun
710-770 Prints 'Got it'

Variables

N Object position
Q The bullet

```

10 PRINT":SHOOT OUT"
20 PRINT"BY IAN FIELDER"
21 PRINT"USE 'Z' TO FIRE"
25 FORQ=1TO3000:NEXT
30 POKE36879,155
40 PRINT"
50 PRINT"
60 PRINT"
70 PRINT"
80 PRINT"
90 PRINT"
100 PRINT"
110 PRINT"
120 PRINT"
130 PRINT"
140 PRINT"
150 PRINT"
160 PRINT"
170 PRINT"
180 PRINT"
190 PRINT"
200 PRINT"
210 PRINT"
220 PRINT"
230 PRINT"
240 PRINT"
242 N=7700
243 N=N+22
244 POKEN,86
245 GOSUB250
246 FORM=1TO5:NEXTM
247 POKEN,32
248 IFN=8184THEN242
249 GOTO243
250 IFPEEK(197)=33THEN260
255 RETURN
260 Q=7909:R=15
261 POKE36878,R
262 POKE36877,255

```

```

265 GOSUB275
270 FORI=1TO11:R=R-1:GOTO280
275 POKEQ-22,78:POKEQ+22,77:POKEQ,42:RETURN
280 POKE36878,R:POKE36877,255:POKEQ+1,46
290 FORJ=1TO5:NEXTJ
295 POKEQ-22,32:POKEQ+22,32:POKEQ,32
300 POKEQ+1,32
310 Q=Q+1
320 IFPEEK(Q+1)=86 THEN 750
345 POKE36877,0
350 NEXTI
500 PRINT"
510 PRINT"
520 PRINT"
530 PRINT"
540 PRINT"
550 PRINT"
560 PRINT"
570 PRINT"
580 PRINT"
590 PRINT"
600 PRINT"
610 PRINT"
620 PRINT"
630 PRINT"
640 PRINT"
650 PRINT"
660 PRINT"
670 PRINT"
680 PRINT"
690 PRINT"
700 PRINT"
710 FORH=1TO2000:NEXT
720 GOTO40
750 PRINT"
756 POKE36877,0
760 FORL=1TO1000:NEXTL
770 GOTO30

```

Shoot Out
by Ian Fielder

TOWN NATHAN

HOME COMPUTERS, SOFTWARE, BOARD GAMES, ROLE PLAYING GAMES AND BOOKS

WEST YORKSHIRE'S LOCAL COMPUTER SHOPS

MORLEY — DRAGON BYTE
51a Queen Street
Morley
Leeds 25
Tel: 0532 522690

HEADINGLEY — LAST CHANCE
10 Ash Road
Headingley
Leeds 6
Tel: 0532 744235

CROSSGATES — HIEROMANS DELL
89 Penda's Way
Leeds 15
Tel: 0532 641855

We're worth a visit because:

- ★ We've probably the best range of software in the North — and we're improving all the time.
- ★ We've a growing range of computers, peripherals, upgrades and books.
- ★ We've the biggest range of Citadel figures for leagues around.
- ★ We've board and adventure games for all ages from TSR, Games Workshop, Avalon Hill, Victory Games, GDW, Yaquinto, etc, etc.

PROGRAMMERS — Assassin Software needs your marketable programs. Give us a call.

TWICKENHAM COMPUTER CENTRE LTD

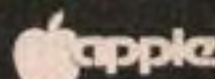

Buy the **BEST BRITISH COMPUTER**

BBC Model A £299
BBC Model B £399

As supplied to schools, local authorities and government departments by the leading BBC/Acorn dealer & service centre

We stock all the extras:
Floppy disk interface
Ecanet network interface
Voice synthesis circuits
Cartridge ROM pack interface
Alternative high-level languages
Cassette recorders
Dot matrix printers
Daisywheel printers
Teletext & Prastel units
Monitors + Disk drives
(subject to availability)

ALL PRICES INCLUDE VAT!
Plus a packing charge

Wordwise Word Processor
Software — Acorn, Bugbyte, Computer Concepts
Acornsoft on Disk • Digitiser Graphics Plotter
Joysticks for the BBC • 100K Single Disk Drives
BBC 800K Twin Disk Drives
Torch 800K Twin Disk Drives with CPN

Another British best!

Ceedata 8200 Word Processor FROM £1,995

64K Internal Memory (up to 256K optional) + Twin floppy disk drives + 80 self-programmable keys (all set for Wordstar) + cables + user manual + C/PM manual + C/PM software with utilities + overlays and keyboard program available.

* Commodore 64: £229

* Apple IIE 64K on special offer — phone for latest price

Now in stock: Acorn Electron £199

ACORN SOFTWARE for the BBC

Peeko-Computer Pack	Arcadians	
Algebraic Manipulation Pack	Sliding Block Puzzles	
Creative Graphics Cassette	Cube Master	£9.95 EACH
Graphs & Charts Cassette	Chess	
Desk Diary		
Philosopher's Quest	Books for the BBC:	
Sphinx Adventure	Creative Graphics	
Monsters	Graphs & Charts	
Snapper	LISP on the BBC	
Planetoid	FORTH on the BBC	£7.50 EACH

Daisywheel Printer for BBC

(complete with interface)
Star 510 Dot Matrix Printer
Star 515 Dot Matrix Printer
Brother Daisywheel Printer
Juki Daisywheel Printer
Black & White TV with Monitor conversion
12" or 14": £55
Cassette Deck (BBC compatible): £30

Acorn/BBC Main Distributors — Trade Enquiries Welcome

Twickenham Computer Centre
72 Heath Rd Twickenham Middx TW1 4BW (Tel: 01-891 4991)

Delivery extra — nationwide by Securitor

DATABASE II

BBC MICRO B ORIC I 48K
ZX SPECTRUM 48K

MICRODRIVE*

... powerful computer filing system ... very fast ... easy to use ... effective and flexible database system. Home Computing Weekly Oric DATABASE review.

The all new, all purpose DATABASE II, fully interactive information retrieval computer filing system. Ideal for use at home and even in business, can be used for endless filing applications, will replace any manual card index-type methods for hobbies, collections, names, addresses, phone numbers etc even Xmas cards!

Specification includes full MICRODRIVE/DISC DRIVE* compatibility, dynamic variable length data, sort by any field, powerful search and erasure by many criteria, fully 'menu' driven making it ideal for novice or expert, user personalisation, save/load (cassette, cartridge, disc) and full printer capabilities etc etc, £7.95 fully inclusive of cassette based DATABASE II, instructions, guarantee and immediate first-class post.

Educationally recommended (Mally).

*Available on BBC disc £9.95 and on Microdrive cartridge £11.95. (buy now on cassette while low prices and transfer to Microdrive under total program control, when you get one!)

THE PRISONER

BBC MICRO B (1.205) by CARL ROBINSON

The very latest most advanced adventure for the latest BBC Micro. You are the PRISONER entrapped in the time machine, in the biggest, best, most enthralling scenario yet devised. Can you escape from the Wild West, World War II London Blitz, Ping Pong Ball, Deep Space Outer Planetary Freighter! We guarantee your ultimate enjoyment in this crazy adventure complete with save routine for part-time prisoners! £7.95 fully inclusive of PRISONER adventure cassette, instructions and immediate first-class post.

Cheque/PO to **DATABASE SYSTEMS, Dept 3**
82 Towers Road, Poynton, Cheshire SK12 1DF
England

Overseas orders + 10 per cent TRADE ENQUIRIES WELCOME

Why not send in your own top quality m/c software for a free validation and evaluation? Why not try our fabulous guaranteed royalties with optional cash advance? All cassettes returned first-class in strict confidence.

COMPUTERAMA

THE COMPUTER CENTRE OF THE NORTH

THE showroom for all the leading micros



easy parking off the M56 (junc 12) • VIC 20 • VIC 64
• BBC micros • Newbrain • Acorn Atom • Books
• Apple 11e, 111 • Dragon • Electron • Games
• Sinclair Spectrum, * IBM P.C.

Secondhand computers • EASY PAYMENTS
ALL ACCESSORIES SALES AND SERVICE

northern computers Churchfield Road,
FRODSHAM
Cheshire WA6 6RD

TEL: FRODSHAM (0928) 35110
* UNBEATABLE PRICES *

WE WILL PURCHASE AND PUBLISH YOUR PROGRAMS! Call Steve Rhodes for details

OPEN FORUM

Cavern Runner

on Vic20

The idea of the game is to dodge the meteors as you travel down the cavern. You have 25 missiles in case of an emergency. Use them carefully. As a last resort there is a hyperspace function to get

you out of trouble. Controls are:

Z = Left
C = Right Or use a joystick, down for hyperspace
M = Fire
Space = Hyperspace

The game consists of two routines, the game and the death section. Each one calls the other routines as it needs them.

The game includes music and hi-score table.

Program notes

10-59 Sets up User Defined Graphics
66-68 Tune
69-119 Instructions
154-230 Main loop
800-910 Death routine and another game
1000-55020 Various routines.

```

0 POKE788,194:HI=100:PRINTCHR$(8):PRINT"J"
  CHR$(142):O=8186
1 DIMP$(8):FORA=1TO8:P$(A)=" 100 *VIC-20*"
  ":NEXTA:COL$="
3 POKE36879,25:PRINT"Q":POKE36878,15
4 FORQW=0TO21:POKE7680+QW,160:POKE8164+QW,
  160:POKE38400+QW,(QWAND7)
5 POKE38884+QW,(QWAND7):NEXTQW
7 PRINT"    CAVERN  RUNNER"
10 PRINT"    -----":PRINT"#####
  (VIC +3K  RAM)"
12 PRINT"#####BY#####A. HAMPTON"
13 PRINT"#####"
15 PRINT"#####DEFINING  CHARACTERS"
16 PRINT"#####PLEASE  WAIT":PRINTSPC
  (5)
20 POKE51,255:POKE52,27:POKE55,255:
  POKE56,27
25 FORI=0TO511
30 POKE7168+I,PEEK(32768+I):NEXTI
35 FORI=0TO(5*8-1):READA
40 POKE7168+I+(35*8),A:NEXTI
50 DATA60,66,157,161,161,157,66,60,56,126,
  255,126,254,248,60,8
55 DATA66,102,126,126,90,102,60,24,16,56,
  108,68,108,108,124,124
56 DATA0,0,255,255,255,255,255,255
59 POKE36869,255:GOSUB51000
60 GOSUB50000:POKE198,0
61 POKE36879,138:PRINT"J":PRINT"#####
  JOYSTICK(J)#####OR#####KEYBOARD(K
62 GETJK$:IFJK$=""THEN62
63 IFJK$="J"THENKJ=0:GOTO66
64 IFJK$="K"THENKJ=1:GOTO66
65 GOTO62
66 FORMU=1TO14:READNN,TT:POKE36876,NN:FOR
  GG=1TOTT:NEXTGG:POKE36876,0:NEXTMU:POKE
  36876,0
67 DATA195,100,187,50,183,100,195,100,195,
  100,195,100,201,100,195,200,187,100,
  3,100
68 DATA195,100,209,150,215,50,219,255
69 POKE36865,160
70 PRINT"    CAVERN  RUNNER "CHR$(35)
75 PRINT"    -----"
80 PRINT"    DODGE THE METEORS AS"
90 PRINT"    YOU DIVE  DOWN THE":PRINT"
  SPC(9)"CAVE."
100 PRINT"    YOU GET MORE  POINTS"
105 PRINT"    THE FURTHER YOU TRAVEL",
110 PRINT"    BUT YOU HAVE 25"
115 PRINT"    MISSILES IN CASE OF AN
  EMERGENCY."
119 GOSUB1000
120 IFKJ=0THENGOSUB9500
121 IFKJ=1THENGOSUB9750
131 PRINT"#####CONTROLS:" :PRINT"
  #####"
132 IFKJ=0THENGOSUB20000
133 IFKJ=1THENGOSUB10500
135 IFKJ=0THENGOSUB9500
136 IFKJ=1THENGOSUB9750
140 POKE36879,8:SC=0:PRINT"
150 PRINT"#####":CE=7933
154 QX$=MID$(COL$,INT(RND(1)*5+1),1)
160 AS=INT(RND(1)*22+1):PRINTTAB(AS)
  QX$CHR$(36)
170 IFPEEK(CE)=36THEN800
180 POKECE,37
190 IFKJ=0THENGOSUB10000
200 IFKJ=1THENGOSUB30000
201 POKE36877,QD:POKE36877,0
226 POKECE,32
227 SC=SC+1
230 GOTO154
800 GOSUB8000:GOSUB55000:POKE36879,8
802 PRINT"#####YOU CRASHED  INTO A
  METEOR."
803 GOSUB7000
805 PRINT"#####YOU SCORED:-":SC
806 IFSC>HITHENHI=SC
807 PRINT"#####HI SCORE:-":HI
810 GOSUB6000:POKE198,0
820 FORA=1TO20:POKE8120+A,38:FORD=1TO100:
  NEXTD:POKE8120+A,32:NEXTA
821 FORD=1TO1000:NEXTD:PRINT"J":
  POKE36869,240
824 S$=STR$(SC):POKE198,0
825 R=0:FORI=1TO8:IFSC>VAL(LEFT$(P$(I),6))
  THENR=I:I=8
830 NEXT:IFR=0THENFORT=1TO500:NEXTT:GOTO875
840 PRINT"JYOU ARE ONE OF THE TOP
  8 PLAYERS."
850 PRINT"    ENTER YOUR NAME":POKE19,1:
  INPUT"#####":I$:POKE19,0:IFLEN(I$)>
  10T..EN840
860 FORI=7TORSTEP-1:P$(I+1)=P$(I):NEXT
870 P$(R)=S$+" "+I$
875 PRINT"#####SPC(5)#####HALL OF FAME"
  :PRINTSPC(5)#####"
880 FORI=1TO8:PRINT"#####I:#####P$(I):NEXTI
890 IFKJ=0THENGOSUB9500
891 IFKJ=1THENGOSUB9750
895 POKE36869,255
896 POKE198,0
905 V=0
910 GOTO140
1000 FORA=160TO38STEP-.1:POKE36865,
  A:NEXTA:RETURN
2000 POKECE,32:CE=CE-1:RETURN
3000 POKECE,32:CE=CE+1:RETURN
4000 POKECE,32:POKE36879,93:POKE36876,
  200:FORZ=1TO500:NEXTZ
4010 RD=INT(RND(1)*21+1)
4015 POKE36879,8:POKE7922+RD,37:
  CE=RD+7922:POKE36876,0:RETURN
5000 IFV>25THENRETURN
5004 FORFI=1TO7:POKECE+22*FI,221:GOSUB9000
5006 IFPEEK(CE+22*FI+22)=36THENPOKE36874,
  234:FORAE=1TO5:NEXTAE:SC=SC+2:
  POKE36874,0
5010 POKECE+22*FI,32:NEXTFI
5020 V=V+1:RETURN
6000 FORDM=1TO11:READW,EE
6010 POKE36875,W:FORS=1TOEE:NEXTS
6020 POKE36875,0
6030 NEXTDM
6040 DATA135,500,135,400,135,100,135,400.

```

PROGRAM OF THE WEEK

Continued on page 53

SOFTWARE FOR SPECTRUM AND ZX81

OUR POLICY

We aim to create programs which you will keep on using until your computer wears out. You won't find our programs in the top ten and you will look in vain for colour adverts and fancy packaging. Nevertheless we have built up a solid following of discerning users in all parts of the world. Read the reviews of our programs if you can find them. We have been consistently praised for quality, originality and value for money.

WHAT DO YOU GET?

The bulk of our cassettes are now made by the factory which produced the Horizons tape. Programs are recorded twice and carry on the reverse side an audio narrative to supplement the operating instructions. Where appropriate, cassettes are accompanied by a comprehensive and clearly written instruction manual.

48K SPECTRUM

"Day of the Match" £5.00

Fascinating and realistic simulation of an entire football season. Name your own teams if you wish (English league provided on cassette). Rate each team from one to nine in various success categories such as attack, defence, manager, etc. Watch the season unfold. Includes knock-out cup option.

"Ball by Ball" £5.00

Simulates a test match series or one day international series. Set up your own teams and pool of players (England v Australia provided). Rate each player's capabilities as batsman and bowler on a one to nine scale for qualities such as talent, effort, etc. Pick your teams and play the match. Electronic scoreboard shows progress of a match. Full supporting score card and series averages.

"Superplan Generator" £12.00

Spreadsheet type program with variable column width and variable number of columns. Lets you sacrifice columns you don't need to get more lines.

"Superplan Pack 1". Business Applications £7.00

Ready made applications programs for sales day book, purchase day book, cash book and petty cash book.

"Superplan Pack 2". Home computing £7.00

Ready made applications programs for home budgeting, nutrition tables, car running costs and bank statements.

"Superview" £5.00

Simple but effective information display. Up to 42 pages of text and low-res graphics. Access pages on demand or run in perpetual 'slide-show' mode. Full facilities to create your own pages and build up an information library on cassette.

16K SPECTRUM

"Superdraw" £5.00

Create full colour high-res pictures and store them on cassette for use as titles or background screens in other programs. Or just have fun doodling and build up a cassette library of your creations. Slide show option allows you to review pictures stored on cassette.

16K ZX81

Here is a selection of titles still available for ZX81. Send sae for illustrated catalogue. These are the ZX81 equivalents of the Spectrum programs described above. Although similar in concept the specifications fall short of the descriptions given for the Spectrum.

"FOOTBALL-LEAGUE" Forerunner of "Day of the Match" £4.00

"TEST-MATCH" Forerunner of "Ball by Ball" £4.00

"VIDEO-PLAN" Forerunner of "Superplan" £7.00

"VIDEO-AD" Forerunner of "Superview" £7.00

"VIDEO-SKETCH" Forerunner of "Superdraw" £7.00

Many independent computer shops now stock our products but we continue to supply by mail order on an off-the-shelf, immediate delivery basis. Prices include VAT, post and packing in UK. Add a bit for postage if you live in Outer Mongolia. (Note: "Day of the Match" not available until late October 1983.)

Video Software Ltd, Stone Lane
Kinver, Stourbridge, West Midlands
Telephone: 0384 872462

Get more out of your Dragon 32

INFOMANAGER

Provides tape-based Dragon 32 users with a tool to develop practical applications. Combining a Data Manager with a Calculator and Barchart generator, and capable of exchanging data, INFOMANAGER has the following features:

- ★ User defined file format.
- ★ Add, update, delete, record.
- ★ Powerful display functions.
- ★ Sort on any field in ascending or descending sequence.
- ★ Formatted printed output suitable for reporting, printing, making labels, etc.
- ★ Transfer of data from the data file to the Calculator and to the Barchart generator.

and more . . .

Apart from the benefit of practical applications, INFO-MANAGER will prove to be informative and interesting, especially to those users unfamiliar with information processing as distinct from games and technical programs.

INFOMANAGER is supplied with full documentation. Priced at £9.00, inclusive of postage.

INFOMANAGER is available from:

J-SOFT
9 Tiverton Avenue
Northampton NN2 8LY

CAMEL PRODUCTS

Spectrum **Oh, BLOW IT!** ZX81

PROMER-81 for the ZX81 blows 2K or 4K Eproms types 2516/2716, 2532/2732. Software on tape. A & T £19.95

PROMER-81S. The very popular low cost programmer for the ZX81 has been adapted to the Spectrum with new software on tape..... £22.95

PROMER-SP will blow 2764/27128 on the Spectrum. Delivery January '84 or earlier. Orders taken now £29.95

ROM-81. An EPROM reader with two 24 pin sockets for '16'32 types for up to 8K in the 8K-16K area. User notes give a small transfer routine for loading Basic programs using USR..... £14.95

ROM-SP. Ingeniously allows up to 16K (2 2764) program to be instantly loaded and RUN on the Spectrum at power-up or on request. Reset button. Cabled, yes, cabled connector. ABS case. NOTE: Sinclair ROM is not disabled by this unit. It stays completely available. Delivery January '84. Orders accepted now..... £29.95

BLOPROM-81

A uniquely sophisticated EPROM PROGRAMMER as used by various labs including Sinclair Research. Resident 8K software. Eprom types 2716 to 27128. Hobbyist and Professional modes. ZX81 and 16K only required — NO EXTRAS. See printout.

£79.95

STATUS	NO. OF SYSTEM	—	HEX
	EPROM TYPE	—	27128
	RAM START ADDR	—	4000
	EPROM ST. ADDR	—	0000
	JOB LENGTH	—	4000
	TASK	—	CHECK

WHICH TASK DO YOU WISH TO DO
W) CHECK THAT EPROM IS CLEAN
X) READ THE CONTENTS OF EPROM INTO RAM
Y) BLOW AN EPROM WITH DATA FROM RAM
Z) VERIFY THAT EPROM DATA IS THE SAME AS IN RAM
Q TO QUIT R TO RESTART

FAST CODES AVAILABLE:

D H PQR WXYZ



UK VAT extra, P&P free
Europe + 5%
Overseas + 10% but no VAT

Cambridge Microelectronics Ltd. One Milton Road, Cambridge CB4 1UY Tel: (0223) 314814

OPEN FORUM

```

151,200,143,200,143,200,136,200,135,200
,130
6050 DATA185,135,425
6055 RESTORE
6056 FORU=1T068:READF:NEXT
6060 RETURN
7000 FORA=7680T07680+21:POKEA,39:POKEA+
30720,3:NEXTA
7002 FORA=8164T08164+21:POKEA,39:POKEA+
30720,3:NEXTA
7004 FORA=7680T08164STEP22:POKEA,39:POKEA+
30720,3:NEXTA
7006 FORA=7701T08185STEP22:POKEA,39:POKEA+
30720,3:NEXTA
7008 RETURN
8000 POKE36879,26:POKECE,38:POKECE+30720,0
8003 Z1=36864:Z2=36865:FORZ3=1T050:Z4=INT
(RND(1)*2+10):Z5=INT(RND(1)*8+32)
8005 POKEZ2,Z5:POKEZ1,Z4:POKE36877,Z20
8010 FORX9=1T025:NEXTX9,Z3:POKEZ1,12:
POKEZ2,38:POKE36877,0:RETURN
9000 FORM=200T0203:POKE36876,M:NEXTM:
POKE36876,0
9002 RETURN
9500 PRINT" "SPC(6)"PRESS FIRE":
POKE37139,0:POKE37154,127
9502 IF(PEEK(37137)AND32)>0THEN9502
9504 RETURN
9750 PRINT" "SPC(7)"PRESS F7"
9751 POKE198,0
9752 IFPEEK(197)<>63THEN9752
9754 RETURN
10000 K=PEEK(37137):Q=PEEK(37152)
10010 IF(KAND16)=0THENGOSUB2000
10020 IF(QAND128)=0THENGOSUB3000
10030 IF(KAND8)=0THENGOSUB4000
10040 IF(KAND32)=0THENGOSUB5000
10050 RETURN
10500 PRINT" "Z-LEFT":PRINT" "C-RIGHT"
:PRINT" "M-FIRE":PRINT" "SPC-HYPER
SPACE"
10510 RETURN
20000 PRINT" "HOUSE JOYSTICK"
:PRINT" "DOWN-HYPERSPACE":RETURN
30000 00=PEEK(197)
30010 IF00=33THENGOSUB2000
30020 IF00=34THENGOSUB3000
30030 IF00=32THENGOSUB4000
30040 IF00=36THENGOSUB5000
30050 RETURN
50000 PRINT" " : POKE36879,42:POKE198,0
50010 PRINT" "SPACESHIP SOUND":PRINT"
"CY:NJ"
50020 GETHH$:IFHH$=""THEN50020
50030 IFHH$="Y"THENQD=255:GOTO50060
50040 IFHH$="N"THENQD=0:GOTO50060
50050 GOTO50020
50060 RETURN
51000 PRINT" "
51002 FORXC=1T0100:UP=INT(RND(1)*506):UL=
INT(RND(1)*7):POKE7680+UP,209:
POKE38400+UP,UL
51003 POKE36876,INT(RND(1)*128+128):NEXTXC
:POKE36876,0:POKE36879,77
51004 FORIY=1T03
51005 FORPI=0T022:POKE36864,12+PI:
POKE36865,38+PI:POKE36866,150-PI:
POKE36867,1.4-PI*2
51010 POKE36876,220+PI:NEXTP1
51020 FORPI=22T00STEP-1:POKE36864,12+PI:
POKE36865,38+PI:POKE36866,150-PI
51025 POKE36867,174-PI*2
51030 POKE36876,220+PI:NEXTP1,IY:POKE36876,0
51040 PRINT" " : RETURN
55000 FORXA=22T00STEP-1:POKE36866,XAOR128:
POKE36867,XA*20R128:POKE36876,220+XA:N
EXTXA
55010 FORXA=1T022:POKE36866,XAOR128:POKE
36867,(XA+1)*20R128:POKE36876,220+
XA:N_XTXA
55020 POKE36876,0:FORJ9=1T0400:NEXTJ9:RETURN

```

Cavern Runner
by Andrew Hampton

Patterns

on BBC

The program produces a pattern on the screen and makes sound effects while doing this. It will run on both BBC machines without any modifications.

Program notes

10-60 Attributes.
80 Change to mode 2.
90-180 First section.
190-280 Second section.

```

10REM *****
20REM *** PATTERNS ***
30REM *** BY ***
40REM *** COLIN ***
50REM *** PRYKE ***
55REM *** AGED 14 ***
60REM *****
70CC=1
80MODE2
90FOR A=1 TO 1280
100SOUND0,-15,A/2,1
110GCOLOR,CC
120MOVE640,512
130DRAWA,1024
140MOVE640,512
150DRAWA,0

```

```

160CC=CC+1
170IF CC=8 CC=1
180NEXT
190FOR A=1 TO 1024
200SOUND1,-15,A/3,1
210GCOLOR,CC
220MOVE640,512
230DRAW0,A
240MOVE640,512
250DRAW1280,A
260CC=CC+1
270IF CC=8 CC=1
280NEXT

```

Patterns
by Colin Pryke



Murder at the Manor

Death comes to a quiet country village when the Lord of the Manor is savagely murdered.

The police are baffled with no obvious clues to help them.

Your skills as an ace investigator are required to identify and apprehend the murderer. This will involve searching for clues (which could be dangerous requiring ingenious deductions), examining the scene of the crime and asking questions of the right people.

What is the mystery of the Gravediggers Hut?

What secret does the safe hold?

What lurks at the bottom of the brook?

These may be some of the questions you will ask yourself during your investigation into the murder at the manor.

The game is based on a fixed map, comprising the Manor House, the Garden, the Town, the Graveyard and many other fully described locations, inhabited by a variety of individual characters whom you are likely to meet.

It is up to you to solve the murder, the locals may know the answer — but will they tell YOU!

This original adventure fills your 48K Spectrum with over 120 locations, all of which are depicted in full colour machine-coded graphics.

Add sound effects, a full score and save game facility plus a comprehensive and easy to use command analyser (incorporating abbreviations and multi-command lines) and you are sure of many exciting and frustrating hours.

WARNING — this is a 4D adventure where night brings added difficulties.

"Highly recommended." (Popular Computing Weekly, Vol 2 No 42).

Cassette and instruction Booklet
costs £6.95 inc.
GEMTIME, 16 Ben Ledi Road, Kirkcaldy, Fife.

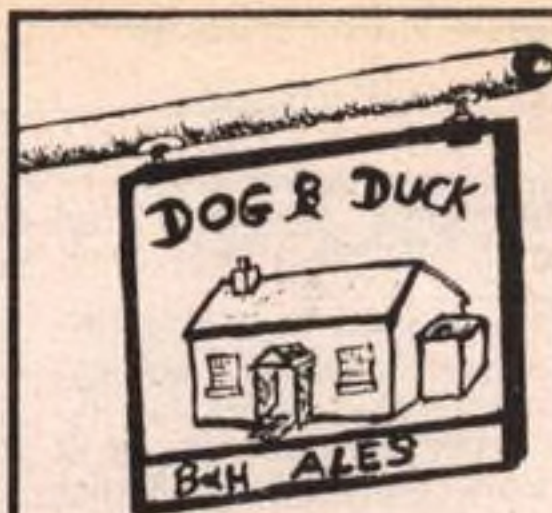
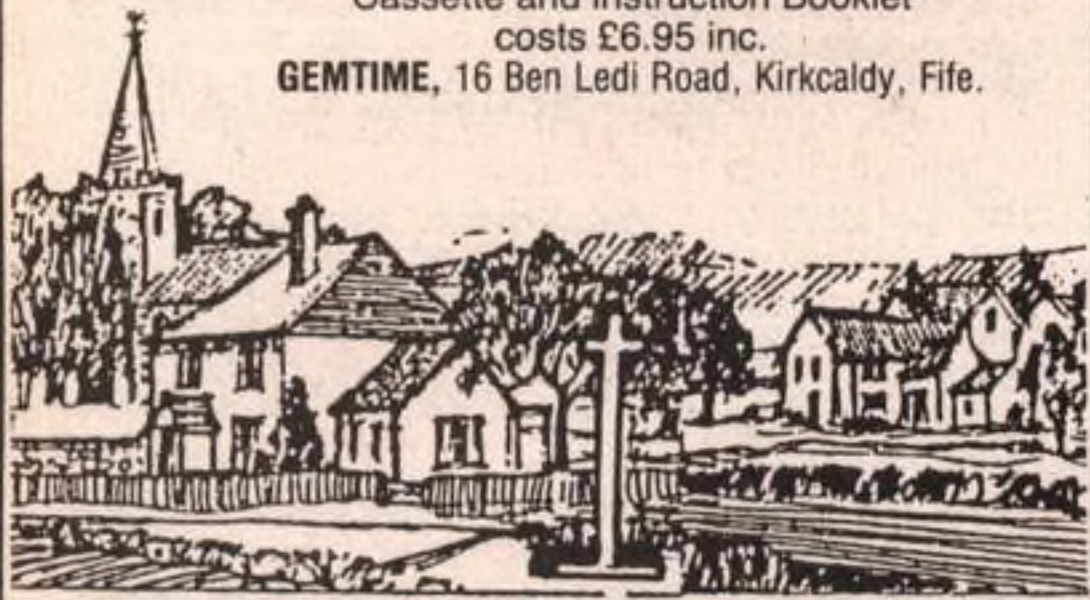

PUB CRAWL £6.95

A 100% machine code, all high resolution graphics game that reaches the parts other games cannot reach. Never mind if the wife has stopped your nights on the tiles; you can crawl around the town, trying to get a drink in each pub with your Dragon 32. But beware the more drinks and nights out you have the more the police will be after you. Watch out also for the traffic on the busy roads. A hamburger occasionally will help sober you, but not for long. A great game with on-screen scoring and high score, high speed action and sound. It's ready when you are Bob!

*** LUNAR LANDER AND RESCUE** £6.95

A brilliant two-part game. Part one is an arcade standard lander which trains you for part two. Here you must rescue lunar engineers in a tortuous cavern. Fuel dump landings and falling stalactites add to the perils of your heroic mission in one of the best Dragon programs available.

"The best version we've seen for the Dragon 32" . . . Dragon Dungeon

"A challenging and well-written game" . . . Dragon User

"Very good" . . . Dragon Data

FREE PARKING £6.95

The first full-feature version of the extremely popular board game available for the Dragon. A complete simulation including buying, selling, mortgaging, etc. etc. The program make full use of the Dragon's colour facilities and incorporates some inspired graphics and sound effects. With options for 2-6 players, continually available instructions and the Dragon as banker, the game is terrific for all the family and there will be no missing £500s!

*** SUBMARINE COMMANDER** £6.95

Navigate the seas to find the enemy with this high-resolution colour simulation. Engage enemy aircraft and ships who will try to torpedo and ram you. Depth charges and under-sea mines add to your problems. You are assisted by torpedoes, periscope view, radar compass, fuel and depth gauges with on-screen displays of ammunition and score. Realistic explosions and sound effects alongside identification sheet, home-coming display, hall of fame and graphic reward for beating the high-score makes this program a masterpiece. TRY IT!

ALL PROGRAMS FOR DRAGON 32
Available from dealers nationwide

For immediate mail order service:
B & H SOFTWARE
208 King Street
COTTINGHAM, HULL

TELEPHONE
0532
450658

LYNX SOFTWARE

FROM BUS-TECH
MORE NEW RELEASES

JUMPING JOHN Control John Simplefellow's movements to retrieve the emeralds. Your king has sent you, a lowly peasant, to the castle of the Evil Baron Dogsbreath. Each stage of your quest becoming harder as you leap the rampart. When the bell rings you move on to a higher level. 5 levels of play with the obstacles becoming more and more hard as you progress. £7.00

MAZE OF DOOM. You are a brave wizard in Candron and your quest is to free the land from the evil oppression by seeking and taking treasure from the temple of evil. Passing through the maze protected by goblins, lizards, etc with spells and stamina etc to assist you. £6.00

Name

Address

Prices include p&p, cheques or P/O made payable to: **BUS-TECH, 19 Landport Terrace, Portsmouth, Hants. PO1 2RG.**
Delivery guaranteed within 14 days or money back.
Please send SAE for Full Software list.
Dealer enquiries welcome.

NEW

The complete
speech synthesis system

For use with
DRAGON 32
COMPUTER

SPEECH SYNTHESIS MODULE for the Dragon 32 computer

- Fully cased module plugs into cartridge port
- Unlimited vocabulary, using allophone-type, dedicated speech chip
- Approximately 250 words predefined; accessed by entering word required
- Complete control using five new BASIC commands
- Speech can easily be incorporated into existing BASIC programs
- Up to 40 words spoken from one command; speech can occur simultaneously with graphics
- £37.95 inclusive

Also available: **SOUND EXTENSION MODULE** for use with the Dragon computer — provides facility to play chords and harmonies over five octaves — easy to use via BASIC — built-in sound effects — music and graphics can occur simultaneously — two I/O ports — user manual — **ONLY £34.95 inclusive**

ACCESS/Cheque/PO to:

J.C.B. (MICROSYSTEMS)

29 Southbourne Road, Bournemouth, BH6 5AE
Tel: (0202) 423973

Write or phone for further details

OPEN FORUM

Close The Box

on Dragon 32

This program is based on the old board game for two or more players. Each player throws dice and covers the numbers indicated by the dice. He continues until no further moves are possible. The board is cleared and play passes to the next player. Any numbers remaining uncovered at the end of a player's turn are counted against

him. More than 45 points and you have lost. This continues until only one player is left.

Program notes

80 Sets up a string of green for blanking out words etc.
 90-170 Ascertain the number of players and their names.
 240-310 Set up board numbers.
 320 Prints the score.
 400-420 Set up colour strings for the board.
 430-510 Draw the board.
 520 Holds the input prompt at the bottom left of

the screen.
 540-800 Enter players choice and prevent inadvertent entering of wrong numbers.
 840 Checks for a winner.
 910-940 Roll die 1.
 970-1020 Print die 1 numbers.
 1030 Checks for board score of six or less and deletes right die if required.
 1040-1080 Roll die 2.
 1110-1160 Print die 2 numbers.
 1200-1280 Instructions.
 1290-1350 Keeps score and notifies losers and the winner.
 The players overall score (in brackets) can be deleted by removing [;"(45 - B + S(I);")"] in line 320.

```

10 CLS
20 PRINT@39, "* CLOSE THE BOX *"
30 PRINT@108, "* FOR *"
40 PRINT@169, "* DRAGON 32 *"
50 PRINT@232, "* J.D.BATEMAN *"
60 PRINT@299, "* 4/10/83 *"
70 FOR D=1 TO 750:NEXT
80 C$=CHR$(143)+CHR$(143)+CHR$(143)+CHR$(143)+CHR$(143)
90 CLS:PRINT@224, "HOW MANY PLAYERS ARE T
HERE(PRESS NUMBER THEN ENTER)
100 INPUTX:CLS
110 T=X
120 DIM N$(X)
130 FOR I=1 TO X:CLS
140 PRINT@224, "PLAYER";I;"PLEASE INPUT Y
OUR NAME."
150 INPUTN$(I)
160 NEXTI
170 CLS
180 PRINT@106, "INSTRUCTIONS?":PRINT@139,
"PRESS Y/N"
190 INPUT Q$
200 IF Q$="Y" THEN GOSUB 1200
210 S(I)=0
220 FOR I=1 TO X:PRINT@0, N$(I);:W=0:W1=0
:W2=0:W3=0:W4=0:W5=0:W6=0:W7=0:W8=0:B=0:
CLS
230 IF S(I)>45 THEN GOTO 1310 ELSE GOSUB
840
240 PRINT@136, "1":PRINT@139, "2"
250 PRINT@142, "3"
260 PRINT@232, "4"
270 PRINT@235, "5"
280 PRINT@238, "6"
290 PRINT@328, "7"
300 PRINT@331, "8"
310 PRINT@334, "9"
320 IF A<10 THEN B=A+B:PRINT@448, "YOUR S
CORE IS ";45-B;"(" ;45-B+S(I);")"
330 PRINT@151, "PRESS"
340 PRINT@181, "REQUIRED"
350 PRINT@213, "NUMBERS"
360 PRINT@247, "THEN"
370 PRINT@278, "<ENTER>"
380 PRINT@310, "OR (11)"
390 PRINT@339, "TO PASS PLAY"
400 X$=CHR$(138)+CHR$(129)+CHR$(131)+CHR
$(130)+CHR$(129)+CHR$(131)+CHR$(130)+CHR
$(129)+CHR$(131)+CHR$(130)+CHR$(133)
410 Y$=CHR$(138)+CHR$(133)
420 Z$=CHR$(138)+CHR$(132)+CHR$(140)+CHR
$(136)+CHR$(132)+CHR$(140)+CHR$(136)+CHR
$(132)+CHR$(140)+CHR$(136)+CHR$(133)
430 PRINT@102, X$;
440 PRINT@134, Y$;:PRINT@137, Y$;:PRINT@14
0, Y$;:PRINT@143, Y$;
450 PRINT@166, Z$;
460 PRINT@198, X$;
470 PRINT@230, Y$;:PRINT@233, Y$;:PRINT@23
6, Y$;:PRINT@239, Y$;
480 PRINT@262, Z$;
490 PRINT@294, X$;
500 PRINT@326, Y$;:PRINT@329, Y$;:PRINT@33
2, Y$;:PRINT@335, Y$;
510 PRINT@358, Z$
520 PRINT@96, CHR$(143);:PRINT@128, CHR$(1
43);:PRINT@160, CHR$(143);:PRINT@192, CHR$(
143);:PRINT@224, CHR$(143);:PRINT@256, CH
R$(143);:PRINT@288, CHR$(143);:PRINT@320,
CHR$(143);:PRINT@352, CHR$(143);:PRINT@38
4, CHR$(143);
530 INPUT A
540 IF A=D1 OR A=D2 THEN L=L+1
550 IF A=D1+D2 THEN L=L+2
560 IF L>2 THEN A=0
570 IF A=W THEN 810
580 IF A=W1 THEN 810
590 IF A=W2 THEN 810
600 IF A=W3 THEN 810
610 IF A=W4 THEN 810
620 IF A=W5 THEN 810
630 IF A=W6 THEN 810
640 IF A=W7 THEN 810
650 IF A=W8 THEN 810
660 IF A=0 THEN 820
670 IF A=11 GOTO 1290
680 SOUND55,5
690 IF A=D1 THENPRINT@19, C$;:PRINT@51, C$
;:PRINT@83, C$;
700 IF A=D2 THENPRINT@25, C$;:PRINT@58, C$
;:PRINT@89, C$;
710 IF A=D1+D2 THENPRINT@19, C$;:PRINT@25
, C$;:PRINT@51, C$;:PRINT@58, C$;:PRINT@83,
C$;:PRINT@89, C$;
720 IF A=1 THENW=1: PRINT@136, CHR$(128);
GOTO320
730 IF A=2 THENW1=2: PRINT@139, CHR$(128)
;:GOTO 320
740 IF A=3 THENW2=3:PRINT@142, CHR$(128);
GOTO320
750 IF A=4 THENW3=4:PRINT@232, CHR$(128);
GOTO320
760 IF A=5 THEN W4=5:PRINT@235, CHR$(128)

```

OPEN FORUM

```

:GOTO320
770 IF A=6 THEN W5=6:PRINT@238,CHR$(128)
:GOTO320
780 IF A=7 THENW6=7:PRINT@328,CHR$(128);
GOTO320
790 IF A=8 THENW7=8:PRINT@331,CHR$(128);
GOTO320
800 IF A=9 THENW8=9:PRINT@334,CHR$(128);
GOTO320
810 SOUND1,5
820 GOSUB 840
830 GOTO520
840 IF T=1 THEN1340 ELSEPRINT@0,N$(1);
PRESS P "
850 PRINT@85,CHR$(143):PRINT@87,CHR$(143)
:PRINT@90,CHR$(143):PRINT@92,CHR$(143);
860 PRINT@32,"FOR YOUR DICE"
870 P$=INKEY$:IF P$=""GOTO 870
880 IF P$<>"P" THEN SOUND 77,7:GOTO 840
890 FOR J=1 TO 20
900 L=0
910 PRINT@21,"*":PRINT@23,"*":PRINT@21,C
HR$(143):PRINT@23,CHR$(143)
920 PRINT@54,"*":PRINT@54,CHR$(143)
930 PRINT@85,"*":PRINT@87,"*":PRINT@85,C
HR$(143):PRINT@87,CHR$(143)
940 NEXT
950 D1=RND(6)
960 PRINT@50,D1
970 IF D1=1 THENPRINT@54,"*"
980 IF D1=2 THENPRINT@21,"*";:PRINT@87,"
*"
990 IF D1=3 THENPRINT@21,"*";:PRINT@54,"
*" :PRINT@87,"*"
1000 IF D1=4 THEN PRINT@21,"*";:PRINT@23
,"*";:PRINT@85,"*":PRINT@87,"*"
1010 IF D1=5 THENPRINT@21,"*";:PRINT@23,
"*";:PRINT@54,"*":PRINT@85,"*":PRINT@87,
"*"
1020 IF D1=6 THENPRINT@21,"*";:PRINT@23,
*";:PRINT@53,"*":PRINT@55,"*":PRINT@85,
"*":PRINT@87,"*"
1030 IFB>38 GOTO 1170
1040 FOR J=1 TO 30
1050 PRINT@59,"*":PRINT@59,CHR$(143)
1060 PRINT@26,"*":PRINT@28,"*":PRINT@26,
CHR$(143):PRINT@28,CHR$(143)
1070 PRINT@90,"*":PRINT@92,"*":PRINT@90,
CHR$(143):PRINT@92,CHR$(143)
1080 NEXT
1090 D2=RND(6)
1100 PRINT@61,D2;
1110 IF D2=1 THEN PRINT@59,"*";
1120 IF D2=2 THEN PRINT@26,"*":PRINT@92,
"*"
1130 IF D2=3 THEN PRINT@26,"*":PRINT@59,
"*";:PRINT@92,"*"
1140 IF D2=4 THEN PRINT@26,"*":PRINT@28,
"*":PRINT@90,"*":PRINT@92,"*"
1150 IF D2=5 THEN PRINT@26,"*":PRINT@28,
"*":PRINT@59,"*";:PRINT@90,"*":PRINT@92,
"*"

```

```

1160 IF D2=6 THEN PRINT@26,"*":PRINT@28,
"*":PRINT@58,"*";:PRINT@60,"*";:PRINT@90
,"*":PRINT@92,"*"
1170 FOR G=0 TO 18:PRINT@G,CHR$(143);:NE
XT
1180 FOR G=32 TO 44:PRINT@G,CHR$(143);:N
EXT
1190 RETURN
1200 CLS:PRINT@9,"close the box"
1210 PRINT@65,"THE PLAYER IN PLAY PRESSE
S <P> TO CAST THE DICE,AND THEN USES TH
E SCORE TO COVER THE NUMBERS (CLOSE THE
BOXES).WITH A THROW OF 5:4 FOR EXAMPLE
,HE CAN COVER 9 (THE AGGREGATE) OR USE
EACH ONE SEPARATELY TO COVER 5 AND 4."
1220 PRINT@289,"THE PLAYER PRESSES <ENTE
R> THENPRESSES <P> FOR THE NEXT CAST OFT
HE DICE."
1230 PRINT@385,"AGAIN HE HAS THE CHOICE
OF THE AGGREGATE OR ONE OR BOTH NUMBERSU
SED SEPARATELY TO CLOSE BOXES."
1240 FOR J=1 TO 28000:NEXT:CLS
1250 PRINT@9,"close the box":PRINT@65,"H
E CONTINUES IN THIS FASHION UNTIL HE
IS UNABLE TO CLOSE AT LEAST ONE BOX,HE M
UST THEN INPUT11 HIS SCORE IS RECORDED A
ND THEBOARD IS CLEARED.THE DICE ARE PA
SSED TO THE NEXT PLAYER."
1260 PRINT@257,"WHEN A PLAYER ACCUMALATE
S MORE THAN 45 POINTS HE DROPS OUT OF T
HE GAME.":FOR J=1 TO 19000:NEXT:CLS:PRIN
T@9,"close the box"
1270 PRINT@65,"IF THE AGGREGATE OF THE
NUMBERSLEFT ON THE BOARD IS SIX OR LESST
HE RIGHT DIE IS DISCARDED.PLAY IS CONTIN
UED UNTIL ALL THE BOXESARE CLOSED OR A S
CORE IS GIVEN WHICH CANNOT BE USED.THE
PLAYER ENDS HIS TURN BY INPUTTING 11."
1280 PRINT@320,"THE LAST PLAYER LEFT IN
THE GAME IS THE WINNER.":FOR J=0
TO 15000:NEXT:RETURN
1290 CLS:S(I)=S(I)+45-B:IF S(I)>45 GOTO
1330
1300 PRINT@99,N$(I);" YOUR SCORE IS";S(I
):FOR D=0 TO 1500:NEXT:IF S(I)>40 THEN F
OR J=0 TO 25:PRINT@235,"BE CAREFUL":FOR
F=0 TO 2:PRINT@235,C$+C$+C$:NEXT F:SOUND
100,1:NEXTJ
1310 ' <C> J.D.B. 4/10/83 <C>
1320 NEXT I:CLS:GOTO 210
1330 T=T-1:PLAY"01L7GFEDC":PRINT@99,N$(I
);" YOUR SCORE IS";S(I):PRINT@204,"you'r
e out":FOR J=0 TO 2500:NEXT J:CLS:GOTO 1
310
1340 CLS:PRINT@235,N$(I)
1350 PRINT@327,"you are the winner.":PLA
Y"04L8CEGL405C04L8GL405C"
1360 PRINT@448,"PRESS BREAK THEN TYPE RU
N TO TRY AGAIN
1370 GOTO1370

```

Close The Box
by J Bateman

The world's first true 3D game.

Postern bring you the first fully
3 dimensional stereoscopic game.

by Mike Singleton

DOEAP

If you've escaped from the Snake Pit, survived The Siege, ridden the mighty Shadowfax and conquered the fearsome Firehawks – see if you're ready for the ultimate experience.

POSTERN



SPECTRUM
VIC 20
COMMODORE 64
BBC 'B'

£7.95

© FRANK MOSES

Postern Ltd. P.O. Box 2, Andoversford,
Cheltenham, Glos GL54 5SW.
Tel: Northleach (04516) 666
Telex 43269 Prestel 37745

This game requires a colour television set
and the special 3D glasses provided with each game.

OPEN FORUM

Quasimodo

on Vic20

This program uses ugd, colour and sound. Move Quasimodo across the screen to ring the bell without being killed by the fireball. You have a time limit and points awarded by how far inside the limit you are.

Once you complete a screen you get a new sheet which is faster. The abbreviation "?" should be used in the print statements at the end of the program.

Variables

Y = Your position.
X = Fireballs position.
SC = Score.
HI = Hi score.
Tm = Time.

L,L\$ = Lives left.
F = Extra life

Program notes

1-9 Sets up user defined graphics.
11-30 Set screen layout.
40-60 Move fireball and print score.
70-140 Move Quasimodo.
300-350 Cleared screen.
400-440 Dead.
500-580 End of game.
1000-1100 Title screen (my highest score is 12,390).

```

0 GOTO999
1 POKE51,255:POKE52,27:POKE55,255:POKE56,
  27:POKE36869,255
2 FORJ=0T0511:X=PEEK(32768+J):POKE7168+J,
  X:NEXT
3 FORJ=0T071:READX:POKE7432+J,X:NEXT
4 DATA24,24,60,90,153,36,34,33,42,92,234,
  255,103,246,90,44
5 DATA127,127,127,127,127,127,127,0
6 DATA254,254,254,254,254,254,0,1,1,
  1,1,1,1,1,1
7 DATA1,1,1,1,3,3,3,7,128,128,128,128,192
  ,64,64,160
8 DATA7,15,31,63,63,126,16,15,160,208,232
  ,240,240,126,8,240
9 POKE36879,8:POKE36878,15:N=0:T=200:Y=78
  34:X=7854:L=3:TM=990:M=2
10 F=0:SC=0:G=0:L$="!!!!"
11 PRINT"J"
20 PRINTTAB(19);"▣&' "
21 PRINTTAB(19);"▣(" "
22 FORJ=1T05:PRINTTAB(19);"▣":NEXT
30 PRINT:FORJ=1T095:PRINT"▣#":NEXT:PRINT
  "#▣"
39 GOTO430
40 X=X-1:IFX<7835THENPOKE7835,32:X=7854
42 POKE7831,37
43 IFSC>=99600THENSC=0
44 PRINT"HI=      HI;TAB(11);"
      TM="TM"
45 PRINT"SC=      SC;TAB(11);"
      RIGHT$(L$,L-1)
46 IFSC>HITHENHI=SC
50 POKEX,34:POKE X+30720,1:POKEX+1,32:POK
  E36876,220:POKE36876,0
55 IFPEEK(X-1)=33THEN400
60 FORJ=1T0T:NEXT
66 TM=TM-30:IFTM<=0THEN400
68 G=G+1
69 IFGCMTHEN40
70 GETA$
80 IFA$="M" THENY=Y-1:POKE36876,200:POKEY+
  1,32
81 IFY=7834THENY=7835
  IFA$="M" THENY=Y+1:POKEY-1,32:POKE36876
  ,200
100 IFA$=" "ANDY>=7833THENY=Y-22:POKEY+22
  ,32:Q1=1:POKE36876,200
111 IFQ2=3THENQ2=0:Y=Y+22:POKE36876,200:P
  OKEY-22,32
115 IFQ2=2THENQ2=3
116 IFQ1=1THENQ1=0:Q2=2
120 POKEY,33:POKE36876,0
130 IFPEEK(Y+1)=34THEN400
135 IFPEEK(7833+20)=33ORPEEK(7833+21)=33
  THEN300
140 GOTO40
300 N=N+1:T=T/1.4:SC=SC+TM
301 TM=990
302 FORC=1T05
310 FORJ=128T0255STEP5
320 POKE36876,J:NEXT:NEXT
325 IFT<10THENT=30
330 IFN=>10THENM=M+1
332 POKE36876,0
333 IFM=>6THENM=6
340 IFSC>1500ANDF=0THENL=L+1:F=F+1
345 FOKEY,37:POKEX,32:X=7853:Y=7835
350 GOTO40
400 FORJ=255T0128STEP-.4
410 POKE36874,J:NEXT
420 POKE36874,0
425 L=L-1:IFL=0THEN500
430 N=0:T=200:TM=990:POKEX,32:POKEY,32:X=
  7853:Y=7835
440 GOTO40
500 REM END OF GAME
510 PRINT"SCORE="SC"X"
540 PRINT"AGAIN [Y/N]?"
  50 GETW$:IFW$=""THEN550
560 IFW$="Y"THEN9
570 IFW$="N"THENEND
580 GOTO550
999 POKE36879,152
1000 PRINT"QUASIMODO":PRINT"
  BY GLENN ACKROYD":PRINT"1983"
1001 PRINT"GUIDE QUOSIMODO TO THE
  BELL BEFORE THE TIME RUNS OUT"
1002 PRINT"JUMP OVER THE FIRE- BALLS!!"
1003 PRINT"CONTROLS:-"
1004 PRINT"CRSR DOWN = LEFT":PRINT"CRSR
  LEFT = RIGHT":PRINT"SPACE BAR = JUMP
  "
1005 PRINT"EXTRA LIFE AT 1500"
1100 GOTO1

```

Quasimodo
by Glenn Ackroyd



The best books for the Dragon 32



The Working Dragon 32

A library of practical sub-routines and programs. ISBN: 0 946408 01 7

- "There clearly is a need for books of this kind which provide more than just games" — *Practical Computing*, Sept 1983.
- "It's a good one" — *Personal Computer News*, May 20 1983



The Dragon Trainer

Written as a combined manual and beginners course on the power of Dragon Basic. It is aimed at the beginner and assumes no previous experience of computing. ISBN: 0 946408 09 2

Dragon 32 Games Master

Learn how to write your own top level games. ISBN: 0 94068 03 3

- "If you can't write a half way decent game after this then it will be down to your own lack of imagination. I would recommend the Brains book as the best of this selection." *Which Micro* — Sept 83



Advanced Sounds & Graphics for the Dragon Computer

All the major aspects of the sound and graphics capabilities of this machine are covered in extensive detail. ISBN: 0 946408 06 8



Plus

Sunshine Software



Cruising

Quick thinking and dexterity are required to master this high speed chase game.

Look out for the Sunshine range in W.H. Smith's, Boots, John Menzies, other leading retail chains and through our national network of bookshops and specialist stores.

Dealer enquiries: 01-734 3454.

Please send me

The Working Dragon 32 at £5.95 each

The Dragon Trainer at £5.95 each

Dragon 32 Games Master at £5.95 each

Advanced Sound & Graphics at £5.95 each

Cruising at £6.95 each

I enclose cheque/postal order for £_____ made payable to: Sunshine Books: 12/13 Little Newport St., London WC2R 3LD

Name _____

Address _____

Signature _____

Or telephone Access Mastercard on 01-734 3454

Microsound 64

The FABULOUS new music keyboard system for the COMMODORE 64

NEW!

Designed for the Musician by Musicians with the following OUTSTANDING FEATURES

- (1) Attractive 4-octave full-size music keyboard
- (2) Making full use of the COMMODORE 64's extensive sound capabilities
- (3) Designed with expansion in mind, ie Add-ons for DIGITAL SAMPLING, LIGHT PEN attachments for waveform synthesis, etc
- (4) Range of software from a Simple Synthesizer to Advanced Sequencing Systems
- (5) Save and Recall an almost unlimited number of sounds

Enquiries to:

Autographics Ltd, 3a Reading Road, Henley on Thames, Oxon RG9 1AB. Tel: 0491 575469

Alien Attack

on Spectrum

The object of this game is to shoot the invader which is coming down to earth. As your score gets higher he gets faster — the higher up the screen he is when you shoot him the more points you get. If the

invader should manage to reach earth, all his friends will join him and the game is over.

Program notes

Lines
2-30 Sets the graphics
100-225 Main program
230-1000 Speed of Invader
2000-2050 Fire
2500-2540 Alien death

3000-3060 Your death
9000-9550 User defined graphics

Graphic notes

120 = Graphic A, Inverse space, Graphic C, Graphic C,
200 = Graphic E
220 = Graphic E
2030 = Graphic C
2510 = Graphic F
3020 = 32 Graphic E's
(Line 222 is simply 32 inverse spaces)

```

1 GO SUB 9000
2 LET SC=0: LET U=10: BORDER
3 PAPER 0: INK 7
4 LET Q=0
5 LET X=20: LET Y=0
6 LET O=1: LET P=10
7 LET S=0: LET F=10
8 LET C=0
9 REM MATH PROGRAM
10 LET Y=Y+(INKEY$="P" AND Y<2
11 (INKEY$="O" AND Y>1)
12 PRINT AT X,Y,"▲"; AT X-1,Y
13 PRINT AT X,Y-1," "; AT X,Y+3
14 AT X-1,Y," "; AT X-1,Y+2)
15 IF S=S THEN GO TO 140
16 LET Z=X: LET C=Y
17 IF INKEY$="a" THEN BEEP .1.
18 GO SUB 2000
19 IF Q=5 THEN FOR E=1 TO 3
20 PRINT AT C,P," "
21 LET D=INT (RND*U)
22 IF D=1 THEN LET O=O+1
23 IF D=2 OR D=4 THEN LET P=P+
24 1
25 IF D=3 OR D=5 THEN LET P=P-
26 1
27 IF P=30 THEN LET P=20
28 PRINT AT O,P,"X"
29 IF O=20 THEN GO TO 3000
30 IF Q=5 THEN NEXT E
31 PRINT AT O,O: INVERSE 1; "S:
32 "; SC; AT O,10; "value of X = "
33 PRINT AT 21,O: INK 4; BRIGHT
34 1:
35 REM DIFFICULTY
36 IF SC>50 THEN LET U=7
37 IF SC>100 THEN LET U=5
38 IF SC>125 THEN LET U=3
39 IF SC>200 THEN LET U=0
40 GO TO 100
41 REM LEVEL
42 PRINT AT Z,C," "
43 IF Z=1 THEN PRINT AT Z+1,C,
44 GO TO 100
45 IF Z=0 THEN RETURN
46 LET Z=Z-1
47 PRINT AT Z,C+1," "

```

```

2040 IF Z=0 AND C=P-1 OR O=Z AND
P-1=C THEN GO TO 2500
2050 GO TO 2000
2060 REM ALIEN DIES
2070 PRINT AT O,P; FLASH 1; "X";
2080 FLASH 0
2090 BEEP .5,30: BEEP .5,40
2100 LET SC=SC+(20-O)
2110 PRINT AT O,P;" "
2120 GO TO S
2130 REM YOU DIE
2140 PRINT AT O,O," " FOR N=1 TO
2150 0
2160 BEEP .5,N
2170 PRINT "*****"
2180 PRINT "*****"
2190 NEXT N
2200 PRINT AT 10,10; FLASH 1; "Go
2210 over"; AT 12,0; "score "; SC
2220 IF INKEY$="" THEN GO TO 300
2230 RUN
2240 REM USER-DEFINED GRAPHICS
2250 RESTORE 9500
2260 FOR I=USR "a" TO USR "!"+7
2270 READ A: POKe I,A
2280 NEXT I
2290 RETURN
2300 DATA BIN 00000001, BIN 00000
2310 BIN 00000111, BIN 00001111, BI
2320 N 00011110, BIN 00111100, BIN 0111
2330 1000, BIN 11110000
2340 DATA BIN 10000000, BIN 11000
2350 000, BIN 11100000, BIN 11110000, BI
2360 N 01111000, BIN 00111100, BIN 0001
2370 1110, BIN 00001111
2380 DATA 0,0, BIN 00011000, BIN 0
2390 011000, BIN 00011000, BIN 0001100
2400 0, BIN 00011000, BIN 00011000
2410 DATA 0,0, BIN 10000000, BIN 1
2420 00000000, BIN 10000000, BIN 1000000
2430 0, BIN 10000000, BIN 10000000
2440 DATA BIN 01111110, BIN 01011
2450 0100, BIN 01011010, BIN 01111110, B
2460 IN 00011000, BIN 00100100, BIN 010
2470 00010, BIN 10000001
2480 DATA BIN 10010011, BIN 11010
2490 111, BIN 00111000, BIN 00111000, BI
2500 N 00111000, BIN 01010100, BIN 1001
2510 0010, BIN 10111001

```

Alien Attack
by P Baillie

Microradio

GW6JJN



Morse tutor

As promised, here are some reviews of amateur radio software on the market. The first tape is a morse code tutor written by two people with the name J E Price. Their call signs are G40IK and G40IL and the mail order address is 4 Housman Walk, Kidderminster, Worcs DY10 3XL; the price of the tape for the 16 or 48K Spectrum is £4.50.

The program by Messrs Price is a professional piece of software which is extremely suitable for learning morse code to the standard required by the examiner. The program opens with some nice user

defined graphics of morse keys hammering away. The program is menu driven and, by selecting the required speed and lesson, the computer patiently bleeps out morse code in groups of letters and/or figures.

You can return to the menu at any time to change the lesson and each time this happens there is a pleasing screen clear routine. A morse tutor is not a very sophisticated problem for a computer, so the routines that are added to this program give it a nice touch of professionalism that makes the tutor value for money.

The second tape received was from G4RWT Amateur Radio Software, 68 Forest Road, Paddock Wood, Tonbridge, Kent TN12 6JX. The price is £4.50 (cheques to R M Walton). This tape consists of a morse tutor for the 16K Spectrum, a morse tutor for the 48K Spectrum and a program called *Sattrack*, also for

the Spectrum. *Sattrack* is, of course, a satellite tracking program.

The first impression is that this tape is good value, two for the price of one, and this impression is confirmed by use. The morse tutor is also a good piece of software, professionally executed and perfectly adequate for learning the code. Again, graphics are used and there are instruction sheets that help in understanding the program.

The accompanying sheets also contain an interface diagram, which will help you to interface the Spectrum to the transceiver in order to send morse code from within the program. One of the menu selections is a morse keyboard, which enables you to send morse simply by pressing the relevant key on your micro.

The *Sattrack* program also has instructions about its use. This program will enable you

to track any amateur satellite, given its orbital data (available from AMSAT). Data is built into the program, but this may need updating from time to time. Since the going rate for a computer program on tape these days is about a fiver, then you must consider this good value. Both the tutor and the *Sattrack* program do what is required of them and both are user friendly in that the user is prompted for input and the instructions are clear.

If there are any other producers of radio software out there, then please let me know — there is far too little radio software about as it is for it to go unused.

Ray Berry GW6 JJN

This series of articles is designed for radio and microcomputer enthusiasts alike. If you have any queries that you want answered, hints and tips to share, or topics that you would like to see covered, write to: Ray Berry, Microradio, Popular Computing Weekly, 12-13 Little Newport Street, London WC2R 3LD.

ZX MICROFAIR

**More Sinclair Computer
games, goodies and presents
than in Santa's grotto.**



GREAT TWO DAY SHOW AT ALLY PALLY DECEMBER 3rd & 4th

There's more to see, more to play with, more to experiment with and more that's NEW for Sinclair Computers at the great **TWO DAY ZX MICROFAIR AT ALLY PALLY!**

Come along and see for yourself. It's the **BIG SHOW** for ZX enthusiasts, plenty of room, bars, refreshments...

in fact the ideal opportunity to pick up that last-minute Christmas present! So, whether you're looking for a Sinclair Computer, hardware, software, peripherals, books or anything that's new...

... there's everything from **GAMES** to **GIZMOS** at the **BIG ZX MICROFAIR!** More than there is in Santa's Grotto!

**GET YOUR
ADVANCE TICKETS
NOW!**

**SATURDAY 3rd DECEMBER and SUNDAY 4th DECEMBER 1983
ALEXANDRA PAVILION, ALEXANDRA PALACE, WOOD GREEN,
LONDON N22. Open: Saturday 10am-6pm, Sunday 10.30am-4.30pm.**

Advance Tickets from: Mike Johnston, 71 Park Lane, Tottenham, London N17 0HG.
Prices: Adults £1 Kids (under 14) 50p. Parties of 10 or more at 10% discount!
Please make cheques payable to ZX MICROFAIR and enclose S.A.E.

CUT OUT AND KEEP

By Road
Follow signs from the A1 (Links with M1 and North Circular). Plenty of parking space available!
Variety of routes from Central London.

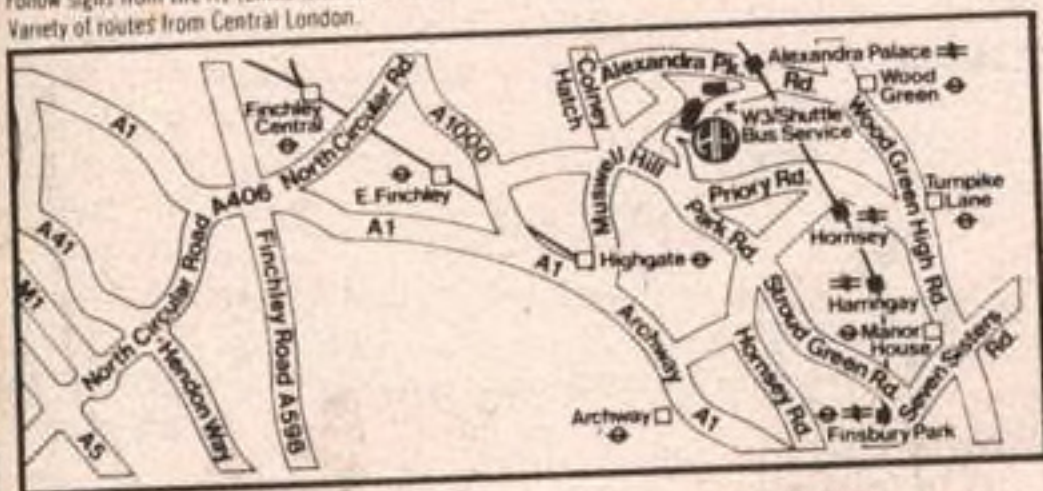

By London Transport
Underground 'Victoria Line from Victoria (also Oxford Circus, Kings Cross, St Pancras) to Highbury and Islington - change (cross platform) to BR Suburban Service to Alexandra Palace - free shuttle bus or 5 minute walk from there!

Alternative Piccadilly Line (from Heathrow etc) to Finsbury Park or Wood Green - Link with W3 bus service to the fair

HEATHROW ← Piccadilly Line



By British Rail
From London (Kings Cross or Moorgate) - about every 10 minutes to Alexandra Palace station - free shuttle bus or short walk from there!
From any part of the U.K. enquire from Kings Cross Travel Centre, London N1 9AP (phone 01-278 2477) about special day trips to the ZX MICROFAIR!

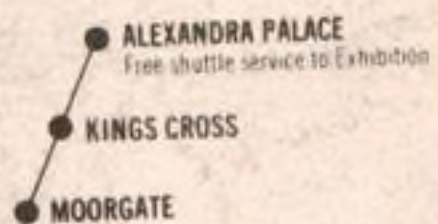

9th
ZX MICROFAIR
ALEXANDRA PALACE
DECEMBER 3rd & 4th 1983



EXHIBITORS! Call Mike Johnston now on 01-801 9172 for details of space at this and future shows!

THE BEST RANGE of SOFTWARE for HOME MICROS

Also
**VIDEO
GAMES**
for ATARI
COLECO
INTELLIVISION
VECTREX

NOW IN STOCK:

Vast Number of Titles for
ATARI 400/800 · SPECTRUM ZX 81 · APPLE
BBC MICRO · VIC 20 · DRAGON · LYNX
ORIC · TEXAS T199 · COMMODORE 64

**THE LARGEST SELECTION
OF GAMES IN THE WORLD**

GAMES CENTRE

Branches: BRIGHTON 52 Western Road
NOTTINGHAM 31 Lister Gate
BIRMINGHAM 141 New Street
BOURNEMOUTH 60 Commercial Road
BRISTOL 15 Broadmead LONDON 22 Oxford Street

Send NOW for
**FREE
MAIL
ORDER
CATALOGUE**

Main Computer & Mail Order Branch:

22x Oxford St · London W1A 2LS

NAME _____

ADDRESS _____



POOLSWINNER

THE ULTIMATE POOLS PREDICTION PROGRAM

- PREDICTS** Not just SCOREDRAWS, but NOSCORES, ALWAYS and HOMES
- IT WORKS** We **guarantee** the program performs significantly better than chance
- ADAPTABLE** "Poolswinner" allows the precise prediction formula to be set by the user — you can develop and test your own unique method. Probabilities are given on **every** fixture — choose as many or as few selections as you wish
- EASY TO USE** Fully menu driven, with detailed instruction booklet
- DATABASE** The program comes complete with the largest database available — over 20,000 matches. The database automatically updates as results come in
- APPLE, BBC (B), COMMODORE 64, DRAGON, SPECTRUM (48K), ZX81 (16K)
£15 (all inclusive)

We produce databases for those developing their own prediction program. Two years results £7.50. Five years results £12.50

Available from dealers, or direct (return of post) from . . .

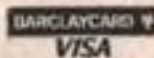

Selec Software



37 COUNCILLOR LANE, CHEADLE, CHESHIRE 061-428 7425
DEALER ENQUIRIES WELCOME

Tread The Path of Adventure with GILSOFT

FOR THE 48K SPECTRUM



MAGIC CASTLE £5.95

Try to rescue the princess from the castle, but beware of booby traps and vampires! A gripping adventure for the 48K Spectrum.



THE QUILL
£14.95

THE QUILL is a major new utility written in machine code which allows even the novice programmer to produce high-speed machine code adventures of superior quality to many available at the moment without any knowledge of machine code whatsoever. Using a menu selection system you may create well over 200 locations, describe them and connect routes between them. You may then fill them with objects and problems of your choice. Having tested your adventure you may alter and experiment with any section with the greatest of ease. A part formed adventure may be saved to tape for later completion. When you have done so THE QUILL will allow you to produce a copy of your adventure which will run independently of the main QUILL editor, so that you may give copies away to your friends.

THE QUILL is provided with a detailed tutorial manual which covers every aspect of its use in writing adventures. For the 48K Spectrum

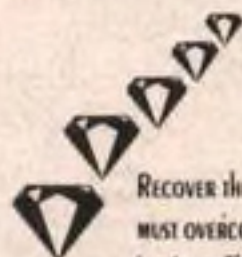

DIAMOND TRAIL £5.95

Recover the Sinclive diamond after a daring robbery. First you must overcome many problems in a city fraught with danger and intrigue. This is our latest adventure for the 48K Spectrum.



TIMELINE & TASKS £5.95

A superb 16K adventure in which you must locate your time machine to return to the present. Plus a collection of mind stimulating puzzles.

Our Software is now available from many computer shops nationwide, or direct from us by post or telephone.

SAE for full details of our range.

Dealer enquires welcome.

GILSOFT

30 Hawthorn Road
Barry
South Glamorgan
CF6 8LE
☎(0446) 736369

Credit Card Order line
Personally manned for 24 hours
☎0222 41361 Ext430



Tony Bridge's Adventure Corner



Dragon advice

Knight's Quest, from Phipps Associates (which I first looked at in issue 42), seems to be holding the attention of a lot of people at the moment. Playing this for the few moments that I could spare, when it first arrived, I thought — yes, a nice traditional adventure, which will pass a few hours. But recently, I have come to look upon it as very much more complex than I had originally thought. And so, it appears, do several of our regular readers.

Geoffrey Larsen, of Clifton, in Bristol, for example, reckons that *Knight's Quest* "becomes increasingly more addictive and difficult as you progress, and I preferred it to *The Hobbit*" — high praise indeed! Susan Schoen, of Cardiff, also enjoyed playing KQ, and sent me an account of her game, written entirely from memory, as her Spectrum had surrendered after giving sterling service for the duration! Thanks to both of you for a lot of very helpful advice, and thanks to Phipps, who have very kindly sent me some welcome hints to help me answer your queries.

A few weeks ago, I gave you the wrong advice to help you deal with the Dragon — at that time I said you would, eventually, need to kill the Dragon, so that you would be able to cross over the river in the ferry. Well, although the Dragon is too heavy to come in the ferry with you, and you will have to cross the river, don't kill the Dragon! I'm afraid that reviewer's short-sightedness overcame me, and I didn't realise that the adventurer would need the Dragon at a later stage (thus going against my own Golden Rule of Adventuring, *Everything has a purpose!*).

The Dragon will be extremely useful to you later in the Adventure, and in his cave, you may find something just as useful (although this will take a bit of lateral thinking, and is not an easy problem to crack). This is only the very start of the Adventure — you'll find a lot more to keep you happy. As Geoffrey Larsen says, "There are many more problems in this game than *The Hobbit!*"

Knight's Quest is an Adventure that will keep you happily frustrated for many a long hour, and is one that I can recommend without hesitation. Incidentally, Geoffrey, if you are still having problems in *Colossal Adventure*, from Level 9, all I can

say is that you are on the right track with the magic words — but you need to say them directly after climbing the beanstalk (remember the fairy story!). Have you found the Emerald yet? Once you have found the treasure that you are seeking, you must use another magic word to deposit the treasure in the building.

From one Dragon to another — I've already had an update, from Dungeon Software, of their latest large release of Adventure programs. The first of the programs is *Return of the Klarz*, the sequel to *Crystal Chalice*, which I mentioned a couple of weeks ago. Then comes *Dream Machine*, which is programmer Mike Meineck's "answer to *Pimania!*" and finally *Back Lot*, which is "an Adventure set after hours on the back lot of a Hollywood film studio".

Mike, feeling that he is not worked hard enough doing all this, is now adding Commodore 64 graphics to the whole range. I haven't actually seen any of these Adventures yet, but apparently many of you have invested in them and are already, says Peter Woods, the Dungeonmaster, ringing in with pleas for help with dealing with the piranhas in the Black Lake, in *Crystal Chalice*.

His advice, which he would like me to pass on to anyone struggling with the problem, is to study how the Brazilian Indians deal with them when crossing rivers!

Sticking with the Dragon, and new releases, Salamander Software have just let loose *Lost in Space* on an unsuspecting world. The subject of this, the second in the Dan Diamond trilogy, concerns the sub-Mike Hammer private eye getting stuck on a derelict spaceship (from Sunset Strip to a trip into the Sun!). The ship is filled with chatty doors (believe me!) and bored robots. The object is to escape, and this you must do by finding your way to the bridge and taking control of the ship.

The display is the same as in Part One, *Franklin's Tomb*. Top left is a description of the current location, and anything that you may be able to see. On the right of the screen is an inventory list, which is visible throughout the game, while the bottom third of the screen contains all your command input and the computers responses. As well as the usual kind of objects found in this type of Adventure, you will also come across several coloured discs, for which you will find special uses (so I'm reliably informed!).

The program recognises a vocabulary of about 50 verbs and 80 nouns — but watch out for Red Herrings and Blue Kippers!

Following the example set by *Franklin's Tomb*, a manual is included in the package, graced by 13 pages of beautifully-drawn pictures of the locations (and these may contain vital clues).

The video-style cases that contain the Adventures seem to be getting bigger with each one — are Dan's cases also getting bigger? Anyway, *Fishy Business* is the third part of the trilogy, and I can't wait!



Gary Miller, of Peckham, in the course of a long letter containing a large gripe (write to the company concerned, Gary, and ask for a Hint sheet. I know that they produce one, and may, indeed, give help on a specific point if you ask), mentions the good old *Hobbit* problem, the Goblin's Dungeon!

This has been covered very well in previous corners, Gary, and I'm not going over it again, but if you are still stuck, and for the benefit of newcomers to *The Hobbit* (and if you are the proud owner of a BBC, Commodore, or Oric, then this program must be added to your collection — ask your favourite aunt to make it a Christmas pressy for you!), then turn to the Adventure Corner in PCW, 21-27 July, where some, if not all, should be revealed.

Gary reckons that *Sorcerer's Castle*, from Mikrogen is one of the ultimate Adventures. He is an old Dungeons and Dragon fan, and obviously enjoys all the good old-fashioned monster-bashing.

There are one or two more programs around that borrow from D&D, although a solo outing on a computer can only really be a rather pale imitation of the original. However, I like *Dungeon Master*, from Crystal Computing, and you should find that it gives you a good flavour of D&D, with Charisma, Wisdom, Intelligence, and all the other details such as Hit Points, lots of Magic Spells and plenty of potions all making an appearance.

Not only that, but *Dungeon Creator*, on the same tape, allows you to actually play *Dungeon Master* and map out and populate your own Dungeon in the privacy of your own home (see a more detailed look at the tape in Adventure Corner, PCW, 22-28 September). An excellent pair of programs which should whet the appetite of the jaded D&Der. ■

This series of articles is designed for novice and experienced Adventurers alike. Each week Tony Bridge will be looking at different Adventures and advising you on some of the problems and pitfalls you can expect to encounter. So, if you have an Adventure you want reviewed, or if you are stuck in an Adventure and cannot progress any further, write to: Tony Bridge, Adventure Corner, *Popular Computing Weekly*, 12-13 Little Newport Street, London WC2R 3LD.

CONSTRUCTOR — FOR THE 48K ZX SPECTRUM
AN EXTRA 77 USER GRAPHICS

Constructor is a user-friendly program that allows you to redefine your Spectrum's character set. With Constructor you can redefine any of 77 of the Spectrum's characters to be any symbol or shape, save the new code for the letter on to tape and use the code in your own programs. Constructor gives you an extra 77 user definable graphics.

ALSO FOR THE 48K SPECTRUM — CHARS 3

Chars 3 gives you three new character sets for your Spectrum — Space Age, Classical and Script. Just load the code, type in two simple commands and your Spectrum's character set is immediately converted to the new one.

Both these programs come complete with user guides, and cost £5.50 each from: Paul Phillips, 13 Mountain Road, Conway, Gwynedd.

COMPUTERS

TO ALL SPECTRUM AND ZX80/81 USERS

Put away all those untidy wires with this new unit designed by a Sinclair user. Holds your cassette player, up to 8 cassettes, printer power pack, your Sinclair and most add ons.

Made of wood, coloured black or mahogany — please state which at £23.50 including VAT and P&P.

Mail order only — please send cheque/PO to:

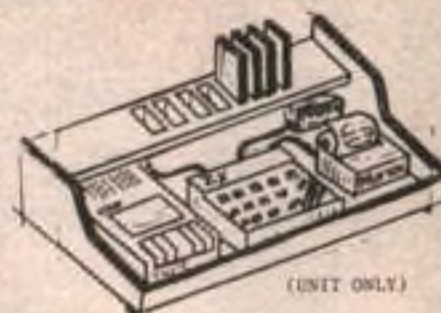

(UNIT ONLY)

E. R. CAMERON & SON LTD
 12 The Vineries, Enfield, Middx EN1 9DQ
 ENQ ONLY: 01-607 2876
 EST 1870. MAKERS OF FINE WOOD PRODUCTS

NOW FOR THE 48K ZX SPECTRUM MULTI-COLOURED SPRITE-GRAPHICS

A new UTILITY program: Replace User Defined Graphics with Multi-Coloured Sprites and greatly improve your games.

FEATURES:

Demonstration program : Character Generator program : Instruction program.

Create any size characters up to full screen.
 Choose colour, bright and flash for each character square.
 Save character data : Create animated characters.
 Beginners guide on how to use Sprites.

Remarkable Machine code routine prints Multi-Coloured Sprites instantly, Unprints Sprites Fully restoring background.

Only £6 including p&p.

From: B. SIDES SOFTWARE

4 Willesden Road, Cefn-Glas, Bridgend, South Wales CF31 4RE



25 BRAMBLE AVENUE, BEAN, DARTFORD, KENT DA2 8BP

Microdeal £7.50, Imagine £5.00
 Virgin £7.50, software for Spectrum, Vic and Dragon Computers. Many more great offers. Send now for latest catalogue. Unbeatable prices.
SEND NOW FOR YOUR CHRISTMAS ORDERS

ALL SOFTWARE PURCHASED FROM EAGLE INCLUDES POSTAGE AND PACKING AND ARE CHEAPER THAN RECOMMENDED RETAIL PRICES

MAIL ORDER ONLY

Home Computer Centre



29 Millcroft, Crosby, Liverpool L23 9XJ
 Tel: 051-727 8050



- VIC 20 16K STANDARD RAM PACK — £27.95
- VIC 20 16K SWITCHABLE RAM PACK — £35.95
- VIC 20 32K SWITCHABLE RAM PACK — £49.95

ALL RAM PACKS CARRY 12 MONTHS GUARANTEE

- VIC 20 4 SLOT SWITCHABLE MOTHERBOARD — £28.95
- CBM 64 4 SLOT SWITCHABLE MOTHERBOARD — £29.95

ASTERFRET TRADING LTD. INCORPORATES HOME COMPUTER CENTRE.

VIC 20 and CBM 64 are reg'd trade marks
 Commodore Business Machines

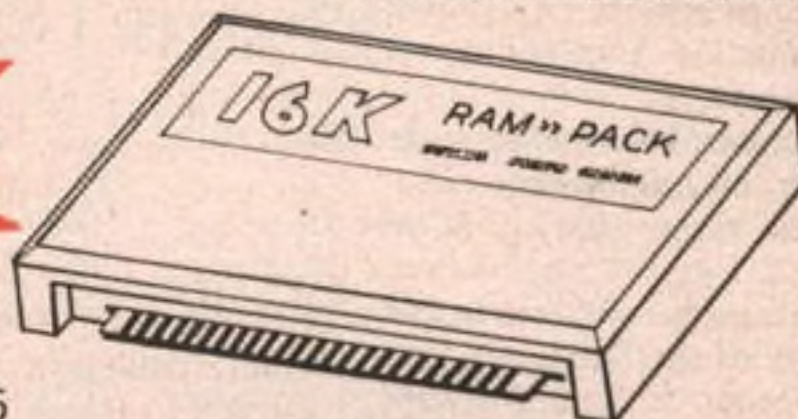

16K STANDARD
£27.95

Please allow up to 21 days for delivery. All prices include V.A.T., postage and packing.

If you wish to be added to our mailing list, please tick the appropriate box

PLEASE SEND ME

- VIC 20
- CMB 64
- BBC
- Lynx
- Oric
- Dragon 32
- TI99/4
- ZX Spectrum
- Electron
- Colour Genie

- Qty
- 16K Std. Ram Pack
 - 16K Switchable Ram Pack
 - 32K Switchable Ram Pack
 - VIC 20 4 Slot Motherboard
 - CBM 64 4 Slot Motherboard

Name _____
 Address _____

I enclose Cheque/PO for £ _____

Home Computer Centre



PCW



IN COMMAND

Michael J Lever of Lilliesfield Avenue, Barnwood, Gloucester, writes:

Q I own two 48K Spectrums, one is an Issue 1, and the other is an Issue 2. I have discovered an interesting, (and annoying) difference, between the two of them. It concerns the *In* command.

Normally the *In* command should return just one value, (255), if no key is pressed. I have used this feature in a number of games, written on my Issue 1 Spectrum. However I discovered that when I *Loaded* the games into my Issue 2, *In* returned a value of 191, and the games did not work properly.

Can you tell me how to remedy this bug, so that 255 is returned on my Issue 2 Spectrum?

A To be fair to Sinclair, the specifications never suggested that *In* would always return 255. The way to get 255 returned is to make sure that 255 is there. If you proceed the *In* with *Out* x, 255 where x is the keyboard value you are checking, then *In* will return a value equal to the *Out* value. Unless, of course, that value is changed by pressing a key.

TAPE TO DISC

David Cartwright of Bowshaw, Dronfield, Sheffield, writes:

Q At the school I attend we have a computer room with 11 computers, three of which are connected to disc drives. I use the computer room quite a lot and we have recently acquired several discs

for the disc drive machines.

However, I have found that the system for saving and loading machine code programs on tape does not work on the discs. Could you please tell me how to put machine code programs on to disc and how to calculate the address.

I know how to transfer from tape to tape but nobody at school knows how to do this on a disc. When I looked it up in the manuals under **Save* it just gave a lot of meaningless address letters, FFFF, 5555 etc. Even the teachers could not help. Please can you help as I urgently need an answer?

A A lot of people have been disappointed when, having bought discs, they find that they cannot easily transfer programs on tape to the disc. Most of the problems stem from the fact that the disc operate by using 2.5K of user RAM. Essentially what you'll have to do is relocate all the programs on tape so that they do not use any of the same space as the discs. The cassette page is at & E00 while the discs are at & 1900. Any program using the space in between will find it already occupied.

To explain in any detail how to move the programs would take an article that is beyond the scope of this page. If you try the following * OPT 1.2 then *CAT and then *Run* the program. At the end you will get the length, load address, and execute address in that order. This should be enough for you to relocate your program.

RAM PACK WOBBLE

Eileen Morris of Beechwood Drive, Woodford Green, Essex, writes:

Q Can you offer some advice to a young at heart pensioner who has just bought herself a ZX81? I bought one of those packs that have the extra 16K RAM in it, and I was doing fine until I put the extra RAM on to play chess. The screen displays the program but it waves all over the place. It's not the cassette recorder. Any advice?

A This letter firmly disproves the theory that

every computer owner is a male under the age of 20. I hope I can solve your problem. There are two likely causes. One is that your television just needs re-tuning slightly. All computers can wander off-channel sometimes, the ZX81 more than most. Adding the RAM pack might help to de-tune it. Because you actually get the program on the screen I think this is the most likely cause of your problems.

The other cause could be something to do with the timing, or the coding of the timing signal. The problem should be in the RAM pack as the computer works well enough without it fitted. Do you find that the pattern "beats" or does it seem random? The easiest thing to check here is that the RAM pack is firmly attached to the computer. RAM pack wobble is still a major cause of faults on the ZX81.

If re-tuning the television doesn't work and you're sure the RAM pack is fixed tightly, I'm afraid you'll just have to return the pack to the manufacturers.

FLAT ADAPTOR

David Jones of Haol Cefni, Ciermawr, Morriston, Swansea, writes:

Q Please can you help a down and out computer Junkie? Last week I trod the streets of Swansea looking for the six-pin flat adaptor for the Vic20 and the C2N cassette deck.

The answer I got from all the computer and audio shops was that my only hope was to contact Commodore direct, and that it would otherwise be impossible to obtain. I have now waited a week and a half but have had no reply from them. Do you know where I might write, phone, or pray to get one?

A What you need is a US standard edge connector.

Is there anything about your computer you don't understand, and which everyone else seems to take for granted? Whatever your problem *Peek* it to Ian Beardsmore and every week he will *Poke* back as many answers as he can. The address is *Peek & Poke, PCW, 12-13 Little Newport Street, London WC2R 3LD.*

PASS WORDS

Shane Gale of Alectus Way, Witham, Essex, writes:

Q I am writing to ask you if, when you are dialling into another computer, you have to guess the pass words? Or is there a manual available that lists them? I already have access to the code numbers of six or seven large computers, but the missing piece of the puzzle is the code words. Can you help?

A No, of course you don't have to guess the pass words, but the whole idea is that only the user knows them, and no one else. Why have a pass word to protect a system, if a list of them were readily available? I can understand the excitement, and sense of achievement, that must come from breaking into a computer system. However, what people do not seem to realise is that apart from being theft, it is also very dangerous, especially if, as has happened in the United States, people try to break nuclear and military computers. These people have now been caught by the FBI.

Remember that the government does not know that your intentions are innocent — if caught you could find yourself being treated more like a terrorist. Breaking generally, it's just likely to create problems in the long-run as companies spend more and more money preventing it. It could, for example, mean that the computer checks the source of each call — a kind of phone tapping. Would you want that?

RUNESOFT



RUNEPACK 1

ORIC 1

RUNEPACK 1: by M R Chambers.
A collection of six programs for all the family for the 16/48K Oric 1.

- 1. Codebreaker
- 2. UXB
- 3. Tick-Tack-Toe
- 4. Hangman
- 5. Windmills
- 6. Biorhythms

Great Value at **£6.95.**

SPECTRUM 48K

SPECTREALM: by J A Slack.
Can you help Spectria survive 100 years under your government policies ... buy power stations ... factories ... fuel ... and food plus many more assets to help Spectria become a world super power. For one or two players, at only **£6.95.**

Send cheques/PO to:

Runesoft, Charnwood House, 67 Lower Parliament Street, Nottingham NG1 3BB

RUNESOFT



SPECTREALM

NEW for ATARI users
A new generation of software for the ATARI 400, 800 & 600 XL

SHATABLAST

You are in the defence ship. The missiles are targeted on you. Only your quick reflexes and accurate shooting can prevent total disaster and the mineral wealth of the Moon Titan falling into alien hands.

A top quality game — 100% machine code
VERY FAST ARCADE ACTION — 3D Graphics. For use with joystick

PRICE **£7.95** incl p&p

Cheques & POs to:

Leisure and Business Developments Ltd
125 Melody Road, Biggin Hill, Westerham, Kent TN16 3PL

THE



RUN

IS COMING

POPULAR **Computing** WEEKLY

Back Issues

Almost all the copies of PCW that you missed can still be bought as back issues for only 50p, including postage and packing.

An index of the contents of the 36 issues published in 1982 is now available from the Publishers for only £1.20. It includes full details of all the programs, routines, reviews and news that you might have missed.

Please send me the following back issues at 50p each:

Total £

Please send me a copy of the 1982 PCW Index at £1.20
I enclose a cheque/postal order for £

Name

Address

Please return to Back Issues, PCW, 12-13 Little Newport Street, London WC2R 3LD.

HIRE A CASSETTE FOR YOUR MICRO

Prices from just 65p per week (minimum two weeks) when you join our library for just £8 per annum (less than the price of some tapes). Thirty days money back guarantee. Our lists are increasing all the time.

ALSO buy tapes from leading manufacturers at **DISCOUNT** prices when you join our club. We are **ALWAYS** looking for new tapes **AND** ideas. If you have written a program why not let us market it for you? Royalties paid for good cassettes!

Send now to **SYLVIA** at:

FRIENDLY SOFTWARE HIRE LTD.
27 CONIFER CLOSE, WHITEHILL, BORDON HANTS. GU35 9DH



ULTRASOFT

BETTER SOFTWARE AT BETTER PRICES

MAIL ORDER ONLY

OLTRO HOUSE (DEPT PCW), 31 KEITH PARK ROAD, UXBRIDGE, MIDDLESEX

COMMODORE 64

ANIROG New releases: Scramble, Hexpert, Moon Buggy, Kong, RRP £7.95 Our Price **£7.50.** 3D Time Trek, Frog Run, RRP £5.95 Our Price **£5.75.** Dungeons, RRP £6.95 Our Price **£6.50.** **INTERCEPTOR** New releases: Siren City, Token of Gaul, RRP £7.00 Our Price **£6.50.** **QUICKSILVA** New releases: Ring of Power, RRP £9.95 Our Price **£9.50.** Purple Turtles, Quintin Warrior, RRP £7.95 Our Price **£7.50.**

DRAGON

MICRODEAL New releases: Crazy Painter, Intergalactic Force, Keys of the Wizard, Frogger, The King, Culbert in the Jungle, Space Shuttle, and all other titles, RRP £5.00 Our Price **£7.75.**

SPECTRUM

ULTIMATE: Jet Pac, Trans AM, Cookie, Pssst, RRP £5.50 Our Price **£4.95.** **QUICKSILVA** New releases: Xadon, Smugglers Cove, Velnors Lair, Aquaplant, RRP £6.95 Our Price **£6.25.**

LATE NEWS: Spectrum and Vic owners — **IMAGINE.** OUR PRICE. Send for our catalogue. Due to complaints **THEY WON'T LET US ADVERTISE OUR PRICES.**

VIC 20

INTERCEPTOR: Crazy Kong, Alien Attack, RRP £6.00 Our Price **£5.00.**

SEND CHEQUE OR POs, OR SEND 12½p STAMP FOR OUR NEW 12-PAGE CATALOGUE, OUT NOW! FREE CATALOGUE SENT WITH EVERY ORDER

Futura Software

Programs for the BBC Microcomputer

- ★ **POWERBOAT RACE (32K)**..... £4.95 (Requires Joysticks)
- ★ **BEAM ME UP SCOTTY (32K)** £4.95
- ★ **SPACE GAMES PACKS 1, 2, 3 AND 4**
Each pack contains three original programs all with a sci-fi theme..... Only **£3.95** each

FREE Space Games Pack with all purchases of two or more games cassettes

ALSO

BLANK TAPES — Superb quality C15 computer cassettes, including labels and library boxes. Minimum order 10
Only **£4.50** including p&p

Send to: Futura Software, 63 Lady Lane
Chelmsford, Essex CM2 0TQ

SOFT SHOP

ATTENTION DRAGON AND VIC20 OWNERS!
Increase your Dragon power to 48K with our Ram Packs

8K Ram Pack	£34.95	<input type="checkbox"/>
16K Ram Pack	£44.95	<input type="checkbox"/>
1 Ribbon Cable	£5.95	<input type="checkbox"/>
Please send me information on increasing my Dragon to 256K + 32K (enclose SAE)		
		<input type="checkbox"/>
Also VIC20		
8K Ram Pack	£24.95	<input type="checkbox"/>
8K + 3K Ram Pack	£30.95	<input type="checkbox"/>
16K Ram Pack	£34.95	<input type="checkbox"/>
16K + 3K Ram Pack	£39.95	<input type="checkbox"/>
All prices include VAT		

Please send me information on increasing my VIC20 to 256K + 16K (Please enclose SAE)

Name

Address

I enclose cheque/PO for £..... made payable to **SOFT SHOP.** Send orders (enclose £1.00 p&p) to:
SOFT SHOP, 66 Catherine Drive, Sunbury-on-Thames, Middlesex TW16 7TG
Please allow 28 days for delivery. All items — 12 months guarantee

CLASSIFIED

Semi-display — £5 per single cc
Lineage — 20p per word

CALL DIANE DAVIS ON 01-437 4343 FOR SEMI/DISPLAY ADVERTISING

GAMES SOFTWARE

For all the family — 48K Spectrum

FIND THE LINK — CALL THE MISFIT

A game of general knowledge, memory, perception, deduction for two to 10 players. 376 different puzzles. Fun for Christmas parties. Ideal as a present. Only £5 including p&p. Cheque/PO, cash to M. I. Mander, Somerford Grange, Brewood, Staffs.

SYPHAX FOR 48K SPECTRUM. 100 different screens of jokes, quizzes, puzzles, British and world information, conversion charts, programming aids etc. For the whole family. Adaptable for your own use. £3.50 including p&p. Rosetta Software, 2 Rosetta Close, Wivenhoe, Essex.

YOUR FORTUNE IN THE CARDS!

using **HORSESHOE OF FATE** for Fortune telling by cards and computer. Family entertainment for the **Spectrum, BBC, Texas and Lynx.** Cards, mystical chart, software and full instructions from: **Black Cat Software (Dept PCW), 1 Westdale Road, Paddington, Warrington WA1 3EN. For £8.99 + 50p (p&p)**



ROBOT PANIC for your 16/48K SPECTRUM

Zap the aliens before the walls crush your Robot. Five rooms of escalating infestation — can you keep up? £5 from retailers (ask) or direct (24-hour dispatch) **Soft Mill 20 Station Road Haddenham Ely, Cambs CB6 3XD**

SOFTWARE SALE

Over 15% off any leading software, for most micros, eg: **Jelpac £4.50, PSST £4.50, Valhalla £13, Arcadia £4.50, Zip Zap £4.50.** And many more, send now for pre-Christmas delivery. We pay postage. Cheque/PO payable to: **ISCOM, 9 Winchester Street, Acton, London W3.** (SAE for list).

GAMES SOFTWARE

SPECTRUM PROGRAMS

BACKGAMMON.....	£5.95
3D VORTE	£5.95
IQ TEST.....	£5.00
HEATHROW.....	£7.95
NIGHT FLITE.....	£5.95
INVADERS.....	£4.95
ESCAPE.....	£4.95
HOME BUDGET.....	£5.00

Many others. SAE for list. Prices including P&P. Cheque/POs crossed, payable to:

VYAJY'S H-K
11 MARGARET AVENUE,
ST AUSTELL, CORNWALL

SPECTRUM 16/48K. Froggy like Frogger, with a time limit for only £3.50. Send to: 56 Exford Avenue, Westcliff-on-Sea, Essex.

LYNX SOFTWARE

THE WORM Our best yet! Guide Wilberforce to the flowers without mishap. You will not want to stop! **£5.95**
REVERSALS Our version of popular board game Reversi in fast machine code. **£4.75.**
LABYRINTH — 3D Maze game. **£4.75.**
CHANCELLOR — Run the UK economy for 10 years. **£4.75.**
SPACE TREK — Zap the Klingons! **£4.75.**
DISASSEMBLER — Examine machine code programs in standard Z-80 mnemonics. **£4.75.**

(Add 10% for overseas orders).

Cheque/PO to: **QUAZAR COMPUTING, Dept. PCW, 67 Estcote Drive, East Grinstead, Sussex.** Other programs available — send for details. Dealer enquiries welcome.

VIC20 + 16K

BEWARE OF KILLER ROBOTS when you play **SECRET MISSION** an adventure with special effects. **£5**

"Addictive as Invaders"
— November Microadventure magazine

KEW ENTERPRISES
14 Fairway Avenue, Manchester 23

16/48K SPECTRUM "Raquel" presents her game for age 16 and over only (state age with order), £3.50. I. Brooks, 17 Malvern Coleman Street, Southend, Essex.

FOR THE DRAGON 32

MOVIE PRODUCER

SPECIAL OFFER **£6.95**

New Original Game.
Can you survive the movie business?
With 3D packaging and free red/green glasses.

CHEQUE/P.O. to: **ED-40, 249 HIGH ST, STRATFORD, LONDON E15 2LS**

FOR ALL THE FAMILY — 48K SPECTRUM

FIND THE LINK — CALL THE MISFIT!

A game of general knowledge, memory, perception, deduction, for two to 10 players. Who can score 100 first? Fun for Christmas parties. 376 different puzzles. Ideal as a present — only £5 including p&p. Cheque, PO, cash to: **M. I. Mander, Somerford Grange, Brewood, Staffs ST19 9DQ.**

DISCOUNT SOFTWARE

HUGE DISCOUNTS OFF SPECTRUM AND ZX81 GAMES

	RSP	Our Price
Jumping Jack (Imagine)	£5.50	£4.50
Hobbit (Melbourne)	£14.95	£11.99
Gridrunner (Quicksilver)	£6.95	£5.95
3D Combat Zone (Artic)	£5.95	£4.95
Devils of the Deep (Shepherd)	£6.50	£4.95
Heathrow (Hewson)	£7.95	£5.95

SPECTRUM GAMESTAPE 16/48K: UFO Attack, Lander and "The Wizard", only £3. Cheques to: Stuart Inger, 12 Nightingale Crescent, Selston, Notts.

LETCHER FOR ADULTS and 48K Spectrum, totally unique, will liven any party. Order now for Christmas. £5.75 to Howard Software, 23 Quines Hill Road, Forest Town, Mansfield, Notts.
SOFTWARE STUDIOS Games Designer. Brand new, unwanted gift, £14 ono. Tel: Clwyd 0244 534618.

UNEXPANDED VIC20 MOWER. Just mow the lawn, but can you do it? Without hitting the cat, gnomes, trees and of course the electrified fence, really addictive, you won't believe it, hi-res graphics, Joystick or keyboard, only £3.50 p&p paid. Epic Software, "Glenross", Bournmoor, Tyne and Wear, DH4 6BH.

VIC20 + 16K

BEWARE OF KILLER ROBOTS when you play **SECRET MISSION** an adventure with special effects. **£5**

"Addictive as Invaders"
— November Microadventure magazine

KEW ENTERPRISES
14 Fairway Avenue, Manchester 23

MICRO CHIP POSTER

40 x 50cm poster featuring Motorola MC68000 16-bit microprocessor chip in die form showing fine circuit details at a magnification of 150x.

SATELLITE POSTERS

41 x 60cm Landsat poster showing whole of UK.
48 x 70cm Meteosat poster showing whole of earth.
All posters in full colour available now at just £1.75 each or £4.50 for any three inc. VAT. Add 55p p&p per order. Send cheques/PO to:

Climax Computer Systems Ltd
17a Broad Street, South Molton
Devon EX36 3AR
Tel: 07695 2314

ENIGMA INCORPORATED SOFTWARE PRESENTS FOR 48K SPECTRUM

"DRONE WAR" Special Offer!

100% MACHINE CODE ARCADE ACTION!
Destroy Opponent — for 2 players only!
FEATURES INCLUDE — Mines, fuel dumps, ammo dumps, 4 robot drones, high-score, etc.

Send to — **Enigma Incorporated Software**
34 Leith Road, Darlington, Co. Durham.

CLASSIFIED ADVERTISING RATES:

Line by line: 20p per word, minimum 20 words.

Semi-display: £5 per single column centimetre, minimum length 2 cm. (Please supply A/W as PMT. Or supply rough setting instructions.)

Conditions: All copy for Classified section must be pre-paid. Cheques and postal orders should arrive at least two weeks before the publication date.

If you wish to discuss your ad, PLEASE RING Diane Davis 01-734 2688.

Here's my classified ad.

(Please write your copy in capital letters on the lines below.)

Please continue on a separate sheet of paper

I make this words, at per word so I owe you £

Name

Address

.....

.....

Telephone

Please cut out and send this form to: Classified Department, *Popular Computing Weekly*, 12-13 Little Newport Street, London WC2R 3LD.

UTILITIES

★ ★ TAPE COPIER ★ ★

The most advanced BACK-UP COPIER for ANY SPECTRUM available. MICRODRIVE COMPATIBLE. Does any other copier come near?

LOOK at only SOME of its options:

- ★ Maxcopy makes working copies of the full 16K or 48K!
 - ★ Verifies. Repeat copies. Automatic abort. STOPS programs.
 - ★ Loads CONTINUOUSLY (not just one part at a time like most copiers) even without pressing a key.
 - ★ Copies HEADERLESS and ALL programs that we are aware of!
 - ★ Very user friendly and simple to use.
- LISTEN. We are so convinced that you will be pleased with our product that we offer a FULL MONEY BACK GUARANTEE if you are not fully satisfied. Cost only £4.50.

LERM. DEPT PW
16 STONEPIT DRIVE,
COTTINGHAM
MARKET HARBOROUGH, LEICS

SUPERB CHARACTER-DESIGNER

— unique cassette. Construct, save, load own graphics, 16K/48K Spectrum. Cheque/PO £5.50 (p&p), to: "Chibur", 3 Lonsdale Street, Leicester LE2 1BP. **BREAKER BREAKER** for the Commodore 64, makes back-up copies of most popular cassette programs. Protect your software investment, £3.95. C. Kent, 26 Northcape Walk, Corby, Northamptonshire.

SOFT SAVE FOR THE VIC20

Allows you to back-up most commercially available software or any memory size on to another tape. Cassette with instructions. £4.95

SOFTSAVE, 65 STONEWOOD, BEAN,
Nr DARTFORD, KENT DA2 8BZ

PROFESSIONAL COPY TYPING, Daisywheel printed. Send originals, instructions and 75p/A4 sheet to Secretarial Services, 15 Mile Street, Bozeat, Northants NN9 7NB.

SOFTSAVE for the Vic20 is a 100 per cent machine code program which allows you to back-up most games on to a new tape. Cassette instructions, £4.95, from Softsave, 65 Stonewood, Bean, Dartford, Kent DA2 8BZ.

VIC IMITATOR

Copies virtually all Vic20 cassette-based programs, including basic machine code, multipart programs and programs using various protection techniques. Written in machine code. Easy to use, works on any memory size. For a quick delivery, send Cheques/POs for £6 to:

IAN WAITE, Dept. PCWK,
11 Hazlebarrow Road, Sheffield
S8 8AU

SPECTRUM TRADE SECRETS. Includes making programs unlistable, unstoppable, invisible. How to reveal such programs, etc. £3. ZX-GUARANTEED, 29 Chadderton Drive, Unsworth, Bury, Lancs.

SPECTRUM 007 SPY. Make copies of all your tapes, Basic, bytes, screen and headerless. Even copies other copiers. No gimmicks, therefore can copy full 16K/48K. Guaranteed easiest to use. Guaranteed to copy more tapes than any other copier. With free header reader and program to Stop/Study machine code programs. Microdrive compatible. Send £3.95 to: ZX GUARANTEED (PCW3), 29 Chadderton Drive, Unsworth, Bury, Lancs (tel: 061-766 5712).

CBM64 BASIC programs accelerated by up to x 40, £3.50 per program, 16K limit. Write to Gestalt, 23c Woodstock Road, London N4 3ET.

SPECTRUM KOPYKAT

IMPROVED PERFORMANCE

Simply the best. Copying any program is now as easy as LOADING and SAVEing your own programs. Any ZX Spectrum program can be backed-up onto a fresh tape. Even programs that cannot be stopped can now be copied. 100 per cent machine code. Copies headerless files. Prints file name. SPECTRUM KOPYKAT uses no program area so full size programs over 41.7K (9K for 16K machines) are easily duplicated. PLUS FREE Header Reader program. Immediate despatch by first class return of post.

Send cheque/PO for £4.95 to:

MEDSOFT

61 Ardeen Road, Doncaster, DN2 5ER

IT CAN EVEN COPY ITSELF

SPECTRUM AUTOKOPY 2

Make back-up copies of ANY Spectrum tape (but do not break Copyright laws)

The most advanced copier yet produced. Copies Basic, Machine Code, Headerless Auto Verifies, and Auto Abort. No protection device too difficult!

The ONLY copier capable of copying programs.

The FULL 16K or 48K LONG!

Send £3 only to B. Tidd, 160 Howlands, Welwyn Garden City, Herts AL7 4RG.

SPECTRUM Kopykats/microdrive, only 007 Spy includes a program to let you copy machine code tapes on to microdrive. See 007 Spy advert.

COMMODORE 64 OWNERS

Assembler — Disassembler, machine code programming cassette — £9.50.
Light Pen Editor — Edit machine code programs using your light pen, plus assembler, disassembler, cassette — £10.50.

MICRO & VIDEO
3 Beatrice Street, Latchford
Warrington, Cheshire

CBM 64 COPIER and header reader, the original L-64 copier program. Makes backups of most tape software, £4.95. "Soft", 82 Hazelton Road, Colchester, Essex.

TELETEXT ON YOUR SPECTRUM: create your own 900-page teletext system with "ZXTEXT". Full colour, graphics, flashing, 24-hour clock with alarm, free sample system — it's all here! Cassette £4.95. **26 Puzzle:** 3D version of Sam Lloyd's famous "15 Puzzle" with full colour 3D display. Try to sort the cubes into order. Cassette £4.95 or both for £7.40. Iain Stewart, 17 Torry Drive, Alva FK12 5NQ.

DRAGON KOPYCAT on cassette. Makes back-up copies for personal use only of machine programs — even protected auto-run, £5.95. D. Gill, 82 Carlton Hill, London NW8 0ER.

HARDWARE

CHRISTMAS SPECIAL OFFERS STOCK CLEARANCE

● **QuickShot Joysticks:** compatible with all Atari Systems, Vic20, Commodore 64, Sears Video Arcade, NEC PC-6001, Memotech MTX 500, etc.

● **Computer Program Data Recorders** — has power lead, 5-pin din, tape counter, ear, mic, remote (will suit any computer)

● **Specially cased C-14 Blank Data Cassettes** with specially designed inlay card RING for the latest prices of the above and all popular Micro computers.

Quantity Discounts available
All orders despatched on receipt.

Tel: (01) 349 3638 2498
anytime for a 5-star service.
TRADE ENQUIRIES WELCOME

BIG DISCOUNTS BY MAIL

SPECTRUMS 48K only £120.95
ORICS 48K just £129.95
COMMODORES 64K £210.00
BBC B MODELS just £385.00

All prices inc VAT + delivery by Securicor

Cheques/POs crossed, payable to: Mr T. Pryle, 70 Carlyle Road, Edgbaston, Birmingham, W. Midlands

SHARP MZ 711

Pre-Christmas bargains.

SHARP MZ 711, 64K Ram

— usually £250 — £229

4-Colour Printer/Plotter

usually £130 — £119.95

Slimline Cassette Recorder

— usually £40 — £34.95

Please add £4.95 for postage and insurance. Send your cheques etc. to: **Softwear City, 17 Great Owl Road, Chigwell, Essex IG7 6AL.**

LYNX LYNX LYNX COMPLETE KEYBOARD PACKAGE OF A DATA STAND PLUS DATA CARDS

- Quality DATA STANDS to help in typing in programs.
- DATA CARDS contain full keyboard information.
- Keyboard entry of user defined graphic characters.
- Also a new approach to number conversion.

Avoid those 0's & 1's. RRP £14.95 plus £1.50 p&p. Dealers enquiries welcome. Cheques & PO's only. Please allow 28 days for delivery.

PERIPHERAL PRODUCTS 209 KENTON LANE, KENTON, MIDDX. Tel: 01-907 3406

SOFTWARE

DAVID SHACK SOFTWARE

Over 150 games for the Spectrum and 100 for the Vic20. Also BBC, CBM 64, Dragon, Atari. Software sold at 10% discount.

SAE for lists to:

294 ROMFORD ROAD, FOREST GATE, E7
Telephone: 01-555 9303

PENNINE COMPUTER CENTRE

£1 OFF ALL TITLES
OVER CHRISTMAS
PERIOD

(ALL MACHINES)

Send for free catalogue
Free p&p

36 WILLOW STREET
ACCRINGTON, LANCASHIRE
Tel: 0254 390424

TEXAS TI99/4A software. Wide range available, from £3.95. Send SAE for list. Apex Software (PCW), Swiss Cottage, Hastings Road, St. Leonards-on-Sea, Sussex TN38 8EA.

P. PERRIS SOFTWARE

presents

DRAGON 32 SOFTWARE

Multi-Maths £1.80, English Test £3.39, Maths Pack £3.99, Hangman with Hi-Res Graphics only £5.99.

Special Offer: "Free with every order before January 1, A C12 Blank Cassette"

Make Cheques/POs payable to: P. Perris, 88 Poplar Crescent, Shipley, West Yorkshire BD18 2HH.

ZX81 — SPECTRUM

We can now offer out-of-guarantee repairs by our Computer Dept. Our engineers have had over three years' experience servicing Sinclair Computer products. Price including p&p. ZX81 — £11.50; 16K Ram — £9.95; Spectrum — £18.75. Send with cheque or PO. T.V. Service of Cambridge Ltd, French's Road, Cambridge CB4 3NP. Tel: (0223) 311371.

EAST LONDON SOFTWARE —

Come to the Roman Road Arcade (Harmers), London E3.

For the widest selection of software in the area for Sinclair, Commodore, Vic20, 64, BBC, etc.

COMMODORE 64 OWNERS

Let us convert your Basic Programs (Bug Free V2 Basic) into M/C.

Send a copy of your BASIC program on tape or disk and our team will convert it into Machine-code. We guarantee to return your tape/disk with a completed M/C program within seven working days.

Only £4.99 (inc. p&p).

Send all Cheques, POs, Programs to:

OMEGASOFT
34 Laurel Drive
Southmoor
Oxen OX13 5DG.

Please don't forget to include a full Name, Address and Telephone number. Any queries then phone Simon on 0855-820469.

"YOUR OWN SOFTWARE BUSINESS"

Start your own full/part time Home Based Software Business. Specially written Manual covers all you need to know including all Legal/Practical aspects, Advertising, Accounts, Sign Writers, Supplies, etc. etc. Order Now! Send £3.99 to: T.M.B. (PC), 15 Clifton Rd., Prestwich, Manchester.

AQUARIUS

BUNCH OF FIVE CASSETTE (Snake, Master-guess, Symon, Bomber, Hi-Lo) £4.95
CASSETTE RECORDER LEAD £1.95

SPECIAL OFFER

Order both: get £1 off total

Save wear and tear on your leads with our own RESET SWITCH
£3.95

SPECTRUM SPECTRASOUND
Audio through your TV £9.00

SAE for further details
MAIL-ORDER ONLY

PROCESSOR LTD.
A.O.S. House
1 Willow Parade
CRANHAM
Essex RM14 1DZ

£500 SPLAT!

HI-SCORE COMPETITION-CURRENT HIGH
MR. SMELIK 51,395 POINTS
 (Subject to Competition Rules)
 SPLAT THE 48K SPECTRUM CHALLENGE
 AVAILABLE NOW £5.50 INCLUSIVE
 INCENTIVE, 54 LONDON STREET,
 READING RG1 4SQ

BEAT THE PIRATES. Major software development, positively beats copying by means of pirate programs. Inventor seeks major company to exploit commercially. Principals only please. Tel: 091-489 8248.

DRAGON SOFTWARE. Excellent condition, 20 cassettes and cartridges. Many popular titles, £90 the lot or sell separately. Tel: Oundle 73710 evenings.

CLUBS

FREE ARCADE GAME when you join Nationwide Computer Club, software exchange, monthly newsletter, discounts, pen pals. SAE for details. NCC (PCW), 12 York Close, Barton, Bedfordshire MK45 4QB.

THE FOUNDATION SCIENCE-FICTION AND FANTASY CLUB. Discounts on books, games, comics, computer software, 45p. SAE to: 104 Deben, Gloucester Road, Tottenham, London N17 6LN.

SPECTRUM SOFTWARE CLUB. Exchange your unwanted software. Buy new programs at a discount. Every new member gets a free program cassette. Send a stamp for catalogue and details. Dept. PCW, 291 High Street, Epping.

SOFTWARE EXCHANGE. Swap your used software via our club. Free membership, £1 per swap, most computers. SAE for details; UKSEC, 15 Tunwell Grave, Sheffield S5 9GB.

★ SPECIAL CHRISTMAS OFFER ★ TO SPECTRUM OWNERS

Send SAE now for list of Games/Educational/Utility Tapes and Books. No rental charges. All you pay as a member is p & p. Members' magazine on cassette. Friendly service guaranteed. Ask about special offer and find out what you're missing.

MICROSOFTWARE CLUB
 73 Alcester Road, Moseley, Birmingham

EDUCATIONAL SOFTWARE

THE PERFECT EDUCATIONAL PRESENT: Maths, 48K Spectrum, age 5-105, 1-2 players, amusing graphical theme, £3.95. S. Burwood, 40 Moreton Avenue, Bideford, Devon.

ARDSOFT EDUCATIONAL SOFTWARE requires BBC computer programmers in a wide range of educational subjects. Royalties paid. Ardssoft, 101 Potternewton Lane, Leeds LS7 3LW. Tel: (0532) 783349.

LYNX 48K. GENUINE BARGAINS 10% DISCOUNT TO NILUG MEMBERS

FRENCH — dictionary — useful phrases — verb, conj. into seven tenses.

HISTORY of England 899 to 1983 plus details of Monarchs. Each prog £5. Both progs in four parts, other software available.

For details Tel: Stonfield 203.
 Write to: M. Lawson "Rosemary",
 Woodstock Road, Stonesfield, Oxford

FOR HIRE

TO HIRE A COMPUTER from ZX81 upwards, ring or write to Business and Computer Services, 292 Caledonian Road, London N1 1BA. Tel: 01-607 0157.

RECRUITMENT

URGENT

We urgently require for a nationwide retailer, quality Arcade games, for Vic20 and Spectrum machines.

Best prices paid for the right programs.

RAINBOW RESEARCH
 288 HIGH STREET
 PONDERS END, ENFIELD, MIDDX

PHOENIX SOFTWARE

Are looking for Machine-Code Arcade-quality games. We have an idea which could make your game the best seller in Europe.

Send your program to

PHOENIX SOFTWARE
 Spangles House
 116 Marsh Road
 Pinner, Middx.
 or Tel:

01-868 3353
NOW!!!

I. G. PROGRAMS

Require Quality Games Programs for CBM 64 and 16/48K Spectrum.

We are also looking for programmers to work to our specifications.

All programs purchased at generous rates.

For further information write to:

I. G. PROGRAMS
 23 NEWALL TUCK ROAD
 CHIPPENHAM
 WILTS SN15 3NL

DEALERS

COMMODORE 64 £164 (Excluding VAT)

Disk drives and cassettes also available
 Tel: Floyd Patterson; Tel: 01-969 0619
 or send SAE

Image Science Micro Computers Ltd
 189 Freston Road, London W10 6TH
 or cheques/POs (add 15% VAT) and £8 for
 p&p Securicor delivery

Full after-sales maintenance on all
 Commodore equipment bought from us

CONTACT Anglia Computer Centre for the Spectrum 16K plus 48K, Vic20, Dragon, Lynx, Vic and Epson HX-20. Tel: (0603) 667-036 (unbeatable prices).

SOFT MACHINE

OPEN MON-SAT, 10.30-6

We offer a selection of the Finest Books and Software currently available for: Oric, ZX81, Spectrum, BBC, Dragon, Vic20 and Commodore 64 Microcomputers.

**3 STATION CRESCENT,
 WESTCOMBE PARK,
 LONDON SE3.**
 Tel: 01-305 0521

or send SAE for free Catalogue
 (State which Computer)

CARVELLS OF RUGBY LTD

37 BANK STREET, RUGBY
 Tel: 0788-65275

Vic20 Starter Pack Computer and C2N Tape unit, intro to Basic Pt1 and 4 games. Only £134, usually £139.95.

Atari 800 + software, £250. 48K Ram + Basic — plus the best of the US software in stock.

We also stock BBC B. Electron. CBM 64. Spectrum and software books. Phone or visit soon!

FOR SALE

ACORN ATOM, 12K. Excellent condition, boxed with over £50-worth of software, £80 ono, £100 ono with cassette recorder. Tel: 061-336 8824 anytime.

CBM64 new cassette, books, software, 5-year guarantee, £250 ono. Reason: doesn't do Pascal. Tel: Andy 722 5434 after 7 pm.

NEW BRAIN, model AD, 32K. Very good condition plus all leads, cassette deck and assembler software. Worth over £300, sell for £200. Tel: Christie, 01-888 7766.

VIC20 plus tape deck, 16K and joystick plus £160 worth of best software and books. Worth £350, sell for £195. Tel: Waterlooville (07014) 51494.

FOR SALE. Hewlett Packard computer, model 9830A (32K), with matrix algebra Rom plus hp daisy wheel printer, model 9871A. Total price £450. Contact Dr Tay Wilson, TAAP, Cranfield Institute Technology, Bedford. Tel: 0234-750111, extension 2235.

DRAGON 32 plus £450 of software plus two joysticks and compatible cassette recorder plus books and magazines and all leads. Tel: Southwell (Notts) 815085. Offers £225.

SPECTRUM 48K with over £60 software including: Hobbit, Spreadsheet, etc. £115. Tel: 01-499 0601.

DRAGON 32, still with box and guarantee, excellent condition, including over £60 software and joysticks, £150. Tel: 01-648 3816 after 6 pm.

DRAGON 32 plus joysticks, cover, £60 software, perfect condition. Tel: 01-648 7819.

TANDY TRS80, Model 1, level 2, 64K VDU twin disc drives line printer, visicalc scripsit 30 discs manuals, £999. Tel: 01-624 7647.

TANDY TRS80 Model 1, level 2, 16K VDU cassette player, manuals, £125. Tel: 01-624 7647.

DIGITAL EQUIPMENT PRINTER, Hoods 3000, DFC LA 200 for printer tables. Tel: 01-977 5120. Offers 10 only.

VIC20, Chopperlifter, Jelly Monsters, Super Lander, 70 games, 16K, £300 ono. Southampton, Fawley 892606.

SP48A 32K RAM for Issue One Spectrum, £15, and TI57 programmable calculator and manual, £15, never used, sell separately or together. Tel: Swindon (0793) 812080 (eves only).

QUEST FOR THE RINGS games for the Philips G7000, £18; Smurf cartridge for Colevisions, £18. Both hardly used. Tel: 01-764 4075.

MATTEL INTELLIVISION game with six tapes, inc Soccer, Skiing, Horse-riding, etc. Sell for £130. Tel: Steven Cornette on 01-876 0095.

COMPUTER SWAP

Computer Swap entries are limited to 30 words. Either fill in the accompanying form and send it to Computer Swap, *Popular Computing Weekly*, 12-13 Little Newport Street, London WC2R 3LD or telephone 01-734 3454.

All software offered through computer swap must be in original condition and for private sale only.

Warning: It is illegal to advertise pirated software.

COMPUTER SWAP

Please write your copy in capital letters on the lines below.

Name.....
 Address.....
 Telephone.....

MAGAZINES

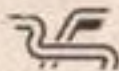

DRAGON USER

To make the most of your Dragon you need **Dragon User** — the independent magazine for Dragon owners. To make sure that you receive a copy of Dragon User regularly subscribe direct to us. A year's subscription costs £8 for 12 issues or subscribe for two years for £14.40 and receive a free copy of either **The Working Dragon** or **Dragon Gamesmaster** (overseas rates available on application). Send a cheque or postal order made payable to Dragon User, and accompanied by your name and address, to Dragon User Subscriptions Department, Oakfield House, Perrymount Road, Haywards Heath, Sussex RH16 3DH.

WANTED

USED MICROS WANTED

FOLLOWING PRICES PAID:

Spectrums 48K..... £65.00
Orics 48K..... £75.00
Commodores 64K..... £95.00
BBC models..... £275.00

Please include leads and send by recorded delivery for cash by return, to:

**Mr T. Pyle, 70 Carlyle Road,
Edgbaston, Birmingham, W. Midlands**

*We also buy Apples, Lynx,
Genies and Texas.*

SUNSHINE

is seeking authors for new titles to add to its highly original and successful book range. Experienced and first time authors are invited to submit manuscripts: ideas or fields of interest. Full details of what we can offer from **David Lawrence, Book Editor, Sunshine**, 12-13 Little Newport Street, London WC2R 3LD.

Sunshine Publishers of Popular Computing and Dragon User.

WANTED

Quality Games and utility programs for any Micro. All programs considered. *Instant cash plus royalties on all programs accepted with a view to distribution in UK, USA and Europe.*

**Dream Software PO Box 64
Basingstoke, Hants RG21 24B
Tel: Basingstoke (0256) 25107**

WANTED. SHARP MZ80K. In good condition. Tel: Horsham 56381 (ask for Graham or Ray).

ACCESSORIES

COMPUTER PRINTED.

Self-adhesive

CASSETTE LABELS

4p each — min. chg. £2 — £3.50 per 100

Black on white (text only) CWO.

Pamcomms Ltd, 21 Wycombe Lane,

Woburn Green,

High Wycombe, Bucks HP10 0HD.

SERVICES

MICRO COMPUTER REPAIRS VERY FAST SERVICE

Vic20 — Spectrums — C64 — Pets

Tel: SLOUGH (0753) 48785

(Mon—Sat)

**WE ALSO REPAIR ALL COMMODORE
SYSTEMS**

Computer Swap 01-437 4343

**Free readers entries to buy
or sell a computer.
Ring 01-437 4343 and give
us the details.**

Spectrums for sale

SPECTRUM 48K (boxed), programmable joystick, Interface with Kempston and over £90 of games plus utilities software. All cost over £270. Sell for £170. Tel: 01-286 0705 after 6 pm.

SPECTRUM SOFTWARE. Astro Blaster, Frenzy, Mind-out, Arcadia, Schizis, Penetrator, Orbiter, Plantoids, Transylvania Terror, 3D Tunnel, 3D Tank, Ground Attack, Derby Day, Horace Goes Skiing, Horace and the Spider, £3 each or swap for other titles. Tel: Dundee (0382) 611825.

48K SPECTRUM plus Kempston joystick plus £150 worth of software including Hobbit, Jetpack, Penetrator, etc. £230. Tel: 01-4851 4884 after 5 pm.

48K SPECTRUM, five months old, with quick shot joystick and £100 of software including Jet Pac, Trans-Am, etc. Still boxed, mint condition, worth £250, sell for £140 ono. Tel: Newmarket 741788.

A BARGAIN for all Spectrum owners, only £10 for a joystick interface, uses standard Atari joysticks and adaptor tape for £5. Tel: Preston (0722) 717607 after 5 pm. Ask for Martin.

ORIGINAL ZX SPECTRUM SOFTWARE: Jetpac, Pssst, Horace and Spiders, Easyspeak, 3D Combat Zone, Spectral Invaders, Arcadia, Voice Chess, Inheritance, Meteor Storm, £4 each. N. Pounder, 59 Hadrian Way, Sandiway, Cheshire, CW8 2JT. Please enclose SAE.

SPECTRUM SOFTWARE for sale. Games Designer (Quicksilva), £10, Fifth Basic Extension (CRL), £7 or £15 for both. As new and boxed. Tel: Mr Cunningham on 0382-23181 extension 651, Monday to Friday, 9 am to 5 pm.

£145 WORTH OF SPECTRUM SOFTWARE for sale including Hobbit, Scrabble, Pimania, Horace, etc. Send SAE for list to T. P. Richards, 39 Cotman Walk, Lockleaze, Bristol BS7 9UG.

FOUR ZX SPECTRUM BOOKS for sale or swap. Over the Spectrum, ZX Spectrum, Spectrum games, 20 Best Programs. Cost over £20, sell for £2.50 each ono. Tel: Harpenden 6006.

48K SPECTRUM, good condition, two months old, £250 worth of software. Tel: Cleveland 585 784 after 5 pm.

48K SPECTRUM with three games, £100 Zenith en 35m. camera £30, Grandstand Astrowars with pro/supply £20, Grandstand Mini-muncher £5, television games £5. Tel: Newton-le-Willows 21444.

SINCLAIR 48K SPECTRUM, £150 software, eight months guarantee, eight months insurance policy, £110. Tel: 021-373 7209 after 5 pm.

48K SPECTRUM plus £70 of software and £180 worth of Lego, will swap for quite new and good condition BBC Model B. Tel: Burgess Hill 2760 after 5.30 pm.

SPECTRUM SOFTWARE, Hobbit, Penetrator, JetPac, Manic Miner, worth £210, sell for £100. Also printer plus three rolls of paper, sound amp, Kempston interface. Any offers. Tel: North Shields 578944 after 6 pm.

48K SPECTRUM DK Tronics keyboard, over £300 software, only three months old, includes: Hobbit, Scrabble, Valhalla, Manic Miner, Games Designer, Kong and many more, £220 ono. Tel: 0375 678813.

SPECTRUM SOFTWARE for sale. Tel: Chesterfield 852-639, ask for Chris.

SPECTRUM SOFTWARE FOR SALE, 12 games for £40 ono. Tel: 01-874 4221.

SOFTWARE FOR 48K SPECTRUM to sell or swap Hobbit £7, Transylvanian Tower, Pharos Tomb, Rescue, £3 each, swap for adventure utilities, etc. Write to: Stesan, Flat 2, 1 Station Road, Lytham, Lancs.

16K SPECTRUM, 12 weeks old, boxed, perfect, and tape recorder, sound expander, programable, joystick, 15 arcade tapes and other. Cast £250, will take £140, can deliver. Tel: 01-674 7631.

FOR SALE, 48K Spectrum and lightpen plus £600 of software, 35 original tapes, £60 of books and magazines, tape recorder. Tel: 0555 71502, ask for Bein, £230 ono.

48K SPECTRUM, two months old, still under guarantee, complete with Sanyo tape recorder, manuals, extra books, magazines, also software, Flight, Golf, Derby Day, Football Manager, Chess, etc., £130. Tel: Mason, 0602 634596.

SPECTRUM GAMES FOR SALE. Astro Blaster, Molar Mall, Cockle, Jumping Jack, £4; Super Spy, Manic Miner, Knot, in 3D, £5; Xadom, £5.50 plus others. Tel: Matthew, 0444 452720 evenings.

SPECTRUM SOFTWARE, Penetrator, Chess, Horizons, Flight, VU-file, books as new, £4 each. Tel: Tonbridge (0732) 361920.

SPECTRUM 48K, two months old, with Sanyo DR101 cassette and four games cassettes plus manuals and computer magazine, £190 ono. Tel: 01-575 3968 between 9 am and 5 pm.

SPECTRUM 48K, sell for £100, software worth £100, sell for £70 or Spectrum and software for £140. Write to: Mount Pleasant, Sherwood Street, Worksop, Notts, Mansfield NG20 0JF.

SPECTRUM ZX, 48K, unused, still boxed, with guarantee + £100 books + software, all for £130 ono. Tel: Alex 01-748 6630.

SPECTRUM ZX, 16K, with software, offers of £75. Tel: 01-690 5673 (Forest Hill), after 4 pm.

SPECTRUM, 48K, all leads and manuals, very good condition + printer, only 1 month old + rolls of paper + vast amount of software. Tel: 01-807 6644, after 4 pm (Edmonton).

SPECTRUM software, over 100 titles for sale, including The Hobbit, Zoom, Aquarius, Manic Minor, Penetrator, Flight Simulation. Send wants list or see to: Mike Russell, 10 Gwastod Terrace, Abertillery, Gwent NP3 1JY.

SPECTRUM SOFTWARE, all perfect originals at half price plus postage, including Scrabble, VU-3D, Flight Simulation, Timegate, Magic Mountain, Monopoly, Inca Curse, 3D-Tunnel, Pharaoh's Tomb, Golden Apple, Phone Rugby 73594 (evenings).

48K SPECTRUM PRINTER, joystick interface, full size keyboard, compatible tape recorder £700 worth of software, 60 originals, £40 books + magazines. Offers only £280. Tel: David 0555 72175.

48K ZX SPECTRUM, printer, 10 rolls of paper, £70 of software, £35 worth of magazines + 2 books for £200. Tel: D. Sparks 01-529 5353.

ZX SPECTRUM SOFTWARE for 16/48K. If you own a Spectrum then don't miss this same day dispatch Jet-Flight £3.50, Picture Maker £2, Sheep Dog £4, Asteroid Dodger £4, Cheques/PO to Gregory Bartlett, High View, Somerton Hill, Laneport, Somerset.

SPECTRUM, 48K, only two weeks old + cassette recorder + over £220 worth of software, worth over £375, sell for £235 ono. Tel: 0387 55706.

SPECTRUM SOFTWARE for sale or swap, Jetpac, Jet Man, Gridrunner, Zoom, Armageddon, Centipede, Leap Frog, Space Raiders, Schizoids, Football Manager. Tel: Chris (after 6 pm) on 021-378 2003.

SPECTRUM SOFTWARE all 50% list price: Hungry Horace, Mined Out, Zoom, Jumping Jack, Terror Daktyl, Morris Meets Bikers, Go To Jail, over Spectrum (utilities and games). Tel: 0734 698094 (evenings).

48K SPECTRUM plus software worth £170 and magazines, £200. Tel: 01-885 1786.

SPECTRUM 48K, 6 months old + quick shot joystick + fuller board + 12 games, including Jet Pack, Time Gate, Pssst, Machine Code book, magazines + more, worth over £300, sell for £200. Tel: 01-992 1362.

SPECTRUM, 48K printer, paper, Fuller master unit + demo + games tape £240. Ring Mark, 01-527 7365 Walthamstow (after 6 pm).

SPECTRUM 48K with 16 cassettes, three months old, swap for Dragon 32. Tel: Thexford 3654 (during day, ask for Robin) or write: 101 Canterbury Way, Thetford, Norfolk.

48K SPECTRUM, two months old + 61 games, tape recorder + magazines, worth £525, sell £250 ono or will separate. Tel: 01-229 2830.

ZX SPECTRUM 48K + printer + joysticks + interface + sound board + 12 software cassettes + other magazines, games + machine code book, cost £300, sell £230. Tel: Bungay (Suffolk) 2043.

SPECTRUM 48K with three channel sound synthesiser + compatible tape recorder + lots of software, only £110. Tel: Dave, Rainham 23341.

48K SPECTRUM, very good condition + £80 software + amplifier, £140 ono. Tel: Romford 45283, after 6 pm.

SPECTRUM 48K PRINTER, rolls of paper, fuller master unit + demonstration and software tapes, £240. Tel: Mark, 01-527 7365.

48K SPECTRUM ZX INTERFACE with new Rom cartridge, four games, Chess Hungry Horace, portable tv, good working condition, £200 (no less). Tel: Alen Turnpike, 01-305 0271, evenings only.

48K SPECTRUM, used one month, tapes, magazines, excellent condition, worth £250, sell for £190 ono. Quick sale, cannot deliver (Liverpool area). Tel: 051-733 0090.

SPECTRUM 16K GAMES for sale, Hungry Horace, Spawn of Evil and Mikro-Gen Scramble, best offer secures. Tel: Sleaford 60694, evenings 7 pm to 9 pm (ask for Howard, if out leave telephone number).

SPECTRUM TAPES, Halls of the Things (Crystal) £5, Phantasia (Rabbit) £4, Espionage Island (Artic) £5. Tel: Dunstable 0582 64575.

SPECTRUM 16K, brand new, never used + 3 games cassettes, total cost £112, selling for £65. Tel: Swindon 812080, evenings or weekends.

SPECTRUM software: over 70 tapes to sell or swap for good Doctor Who items. See for list or offers to: Edward, 9 Stanford Crescent, Little Plumstead, Norwich, Norfolk NR13 5JL.

SPECTRUM 48K, £95, software cassette, all original, half price, Reversi, Penetrator, Space Intruder, Berserk, Cascade, 50 Games, Horace, etc. Tel: 01-304 3659.

SPECTRUM PROGRAMS including: Scrabble, Trader, Horace, Zip Zap, ZZoom, Combat Zone, Cookie, Trans-Am, etc. Lists: A. Moran, 23 Egerton Road South, Chorlton, Manchester M21 1YP.

SPECTRUM SOFTWARE to swap or sell. Tel: John after 5 pm on Waltham Cross 21260.

ZX81s for sale

ZX81 with 16K and software and books, all for £25. Tel: 01-625 5007 after 6.30 pm.

SWAP 16K ZX81 with software and tape recorder for T199. Tel: David, 01-654 4305.

ZX81 16K, plus printer and file sixty keyboard, over £80 worth of software, will sell for £70 ono. Tel: Bicester 246938.

ZX81 SOFTWARE includes: Chess, 3D Monster Maze, Invaders, Scramble, Asteroids, loads perfectly, very cheap. Tel: 01-540 7860 for prices and details. Hurry, first come, first served.

ZX81, 16K, with £70 worth of best selling software including: PacMan, Donkey Kong, Asteroids, Scramble, Defender, Galaxians, Flight Simulation, Tempest, Football and others. Sell for £40. Tel: Malton (0653) 4547.

16K ZX81, still under guarantee, good condition, £35. Tel: 0202 699013.

ZX81, 16K, over £50 software including Flight Simulation, Trader, manual, leads, etc., sell for £45 ono. Tel: Amersham 4920 (after 6 pm) and ask for Nick.

ZX81 FOR SALE, 16K, book, £35. Tel: 01-776 1462.

SINCLAIR, 16K, ZX81, manual, several books + magazines, £30 of software including Black Crystal + Flight Simulation, sell for £60 ono, or swap for Spectrum. Contact Mike, 64 Crabtree Walk, Peckham, London SE15.

ZX81, 16K, file 60 keyboard, 13 cassettes, Mazogs, Cooter Attack, ZX Chess 2, Flight Simulation, Hi-res, 35 magazines + Machine language book, ideal Christmas present, bargain £90 ono. Tel: 01-427 2563 (eves).

ZX81, 16K, Flight Simulation cassette, sell or swap — send offer to Mr Leece, 30 Grainger Close, Basingstoke, Hants. Tel: 22409.

ZX81, 16K, DK tronics keyboard, case, lots of software, books, joystick, £60 ono. Tel: 01-992 6292.

ZX81 + PSU + 32K Ram (uncased) + 3 games, Basic games book + magazines, sell £40, or exchange for Aquarius, cash adjustment to £50. Tel: 01-853 5993.

ZX81, 16K Ram pack, 15 games, £40 ono. Tel: Manchester 427 6392.

16K ZX81 complete with over £50 worth of software, including Black Crystal, Mazogs, Chess, Football Manager and Frogger plus magazines. All for £50. Tel: 0522-680080 (after 6 pm).

Commodores for sale

VIC20 with cassette joystick, 16K Ram pack, five games, Introduction to Basic Part 1, Rabbitt Database graphic adventure game, Money Management program, Programmers Reg Guide, 30 magazines plus black and white TV, £135. Tel: Slough 35977.

VIC20 with power lead for sale, £75. Tel: 01-960 0805 evenings only.

VIC20 plus 16K cassette unit, Programmers Aid cartridge, Introduction to Basic, Part I and II, five cartridges, over £200 worth of cassettes and £50 worth of books. Offers please. Tel: 061-491 2117 day; 0254 580351 evenings.

VIC20 SOFTWARE to swap or sell. Tel: 05212 3503.

VIC20 SOFTWARE FOR SALE, all original, including Jetpac, Wacky Waiters, Kong and Adventures, only £3 each or the lot for £25. Phone Michael Barker (after 4.30) on 051-5484242.

VIC20 SOFTWARE FOR SALE, £1 under original price + Super Lander cartridge. Tel: Erith 41849.

COMMODORE VIC20 with 16K expansion + Adventureland cartridge, C2N cassette, Vic Revealed book, £130 ono. Tel: 0555 70992.

COMMODORE 64 software for sale or swap tape or disk. Tel: Peter, 577 2476.

VIC20 C2N cassette, stack storeboard with 8K, joysticks, 2 games cartridge, Chess cartridge, dust cover, Vic revealed £155; machine/code cartridge £25. Tel: 01-422 6331.

COMMODORE 64, Frogger, Scramble, Crazy Kong, Camels, Hungry Horace, original software, £18 the lot, less than half price. Tel: Great Yarmouth 0493-661024.

VIC20, cassette, software sale/swap, also cartridges (adventure) many titles from Anirob, Imagine, Rabbit, Romik, Bug-Byte, Audiogenesis, Commodore, Llamasoft, etc. All enquiries welcome now! Tel: Mitchell (0362) 4497 (after 4.30 pm).

VIC20 SOFTWARE, to swap or sell: Arcadia, Gorf, Amok, Skramble, Road-Race, Frantic, Traxx, Andes Attack. Tel: Buckland St Mary 213 (after 5 pm).

VIC20 + 3K, datassette, joystick, super expander and four games cartridges, over 200 programs on cassettes, many magazines and four books, worth over £320, sell for £120. Tel: Tatsfield (09598) 656.

COMMODORE VIC20 with cassette unit, joystick, £200 of software, 3 books, cost £410, sell for £150. Tel: Luton (0582) 507442 (after 4 pm weekdays).

VIC20 + magazines and box, £80 ono. Tel: 0298 3158 (after 5 pm).

COMMODORE VIC20, still under guarantee, data recorder unit machine, language monitor, joystick, 4 games, programmers reference guide, Introduction to Basic Part I, learning to use Vic20, £30 games + user's manuals, £160. Tel: (0582) 660856.

VIC MASTERMIND + 4 data tapes, quizmaster, Biology, Road User, Wizard and Princess adventure pack + Hopper, £35 the lot or will separate. Phone Ingebourne 76431.

VIC20 + cassette unit + joystick + games + books and magazines, £100. Tel: 01-7471242 (after 4 pm).

SWAP THE COUNT for Pirate Cove or Voodoo Castle — Vic20. Tel: 0642-762475.

VIC20 COSMIC Crunchers cartridge to swap for any adventure cartridge or to sell for £5. Tel: Norwich 413673.

VIC20 CASSETTE DECK, 16K Ram Pack, £50 worth of software. A joystick, Introduction to Basic manual, worth £230, will sell for £150. Contact G. Davis. Tel: Rochdale 38893.

COMMODORE PET 32K cassette player. Many tapes, green screen, Basic 3, Disk-o-Pro-Chip, £300 ono. Tel: 01-398 6963, ask for Simon.

VIC20 plus cassette recorder, Super Expander 3K, 16K, Introduction to Basic at I and II, five books, eight cartridges, Programmers Aid cartridge plus £700 worth of software, joystick and other accessories, £350 or will split. Tel: 01-578 2302.

COMMODORE 64 SOFTWARE, Falcon Control, £3; Grave Robbers, £3; Crazy Kong, £2; Adventure Pack, £3; Melbourne House Super Cassette A and B, £4 each, Jumpman on disks, £20. Tel: 6787 60168.

VIC20 MACHINE CODE MONITOR, with manual, half price at £17, works perfectly. Contact Paul McDonnell. Tel: Oxford 862864.

VIC20 cassette recorder, 16K Ram, 2 joysticks + super expander, £150. Tel: Fauld House (West Scotland) 70221.

VIC20, 10 months' old, cassette recorder + 16K Ram pack, graphic packing, £80 software, manual + teaching book, £175. Tel: 061-794 8710.

VIC20, C2N cassette introduction to Basic Part I, Asteroids, two months' old, hardly used, £100. Tel: Medway (0634) 719194.

VIC20 Llamasoft Defenda and Imagine Arcadia to swap for any Spectrum tapes. Tel: James Frost 01-485 6213.

VIC20, C2N cassette deck, super expander, lots of magazines and programs, including: Skramble, Panic, Night Crawler, Arcadia and lots more, £130. Tel: 0532 401798.

VIC20 + cassette player + Point Master joystick and 3 cartridges, including: Gorf, over 70 games, £160 ono, or swap 48K Spectrum + recorder and software. Tel: 0254 889237.

COMMODORE 64, games: Startrek, Othello, Connect 4, Painter, £5 each. N. Wareing, 13 Sunningdale Road, Denton, Manchester M34 1QP.

SECOND-HAND VIC20, tapes + cartridges for sale. Tel: Dean 530883.

VIC20 CARTRIDGES, including memory, games + utilities, half price, also cassette + soft switch, half price. Tel: 01-574 4122.

VIC20 + cassette + Super Expander cartridge, £150 of software, Reference Guide, joystick and magazines, £400, will accept £135 ono. Huddersfield 0484 48964.

VIC20, cassette deck with additional memory of 16K + 3K, also Reference Guide + Amber 2400 printer with interface, 4 rolls of paper + ribbons, 3 cassette games: Bonzo, Abductor, Crazy Kong, also 3 Rom games: Pirate Cove, Radar Rat Race, Jelly Monsters, will not separate items, £180 or will swap for 48K Spectrum with printer. Tel: Chris King, 01-580 4741 ext 82 or after 8 pm Ashford (Kent) 20228.

VIC20 CARTRIDGES: "The Count", Cosmic Jailbreak, Gorf, Cassettes Matrix, Arcadia, Catcha Snatcha, Frantic Mint, £30 ono, or swap ZX printer or 16K ZX81. Please write: Woolley, 43 Jetson Street, Gorton, Manchester.

VIC20 CHOPLIFTER CARTRIDGE, swap for Spiders Mars or Outworld, also swap Commodore 3K Ram for software, also cassettes to swap. Yateley 872310.

VIC20, tape deck, joystick, cartridge, £75 of software, books, magazines, offers around £200. Tel: 01-397 0660.

VIC20 + C2N cassette + 16K Ram pack + £200 of quality software, including: Education, Adventures, Arcadia, accept £200 no offers! Tel: 01-958 3213.

VIC20 and cassette unit plus £130 of software, including: Cosmic Cruncher, also program reference guide and Watson's Assembler, also joystick, all worth £300, offers near £190. Tel: 0603 47592.

VIC20, 8K Ram, cassette deck, intro to Basic I, joystick, cartridges includes Jelly Masters, Android Attack, all boxed as new, still under guarantee, £120. Tel: Mottram 44071 (Manchester).

VIC20 16K, cassette, motherboard, super expander, programmer's aid, joystick, light pen, technical manuals, five games cartridges, adventure games, £200 software, £250 ono. Tel: Surbiton 01-390 5043.

VIC20 plus C2N cassette unit, 16K Rampack, Introduction to Basic, £75 software (Omega Race) and magazines, £165 ono. Tel: 041 772 2055 (Glasgow).

VIC20 CASSETTE UNIT, switchboard 32K, Super Expander switchable motherboard, £60 software, two games cartridges and 100 magazines. Reference guide: cost £400, sell £200. Tel: Fleet (02514) 3692.

VIC20 plus cassette unit, three cartridges, six cassettes and book, worth over £290, sell for £170 or swap for Spectrum 48K plus games and joystick interface. Tel: 881 0228.

COMMODORE 64, software (cassette and disk) for sale. Tel: 577 2476 (P. Peter, anytime).

Dragons for sale

DRAGON 32 plus £68 software and two joysticks, manuals plus five games and programs, £170. Tel: Leeds 693736.

DRAGON 32 plus £300 worth of software, two joysticks, cassette deck and books, £270 ono. Tel: Mike, Bristol (0272) 613309 after 7.30 pm.

DRAGON 32, joystick, £260+ of software which includes: Composer, Planet Invasion, Assembler and lots more. Magazines, books, two cartridges, hi-res, Starship Chamalon, £240 ono. Contact: P. Tracy, Warton 635353 after 6 pm.

DRAGON 32 software for sale or swap. Planet Invasion, Space War, Chess, Frogger, £6 each or swap for Microdeal, J. M. Morrison, etc. No adventures or compendiums. Write to: Paul Fisher, 9 Nelson Close, Mickleover, Derby.

DRAGON 32 plus cassette player, 2 joysticks, programming books, magazines and software, £110 ono. 22 Upfield, Horley, Surrey. Tel: 02934-2613.

DRAGON 32, cassette, joysticks, software and books including two cartridges, Tasman Demon Assembler, Invaders, magazines, £350 worth of software including Microdeal and Morrisons best sellers plus other programs, swap BBC model or 300 or nearest offer. Tel: Grimsby 851391 or 851708.

DRAGON 32, four months old, joysticks, cassette loader, £50 of software plus books, £220 ono. Tel: 01-206 0919.

DRAGON 32, perfect, under guarantee, all leads and software (Microdeal, Salamander), 2 Microdeal joysticks, interface, books and light pen, worth £475, sell for £299. Tel: Medway (0634) 270317.

DRAGON SOFTWARE. Original cassettes, leading titles, vastly reduced prices. Private sale. Send SAE for list to: John Hall, 2 Mitchell Street, Burnley, Lancs BB12 0HH or Tel: 0282 57057 evenings.

DRAGON 32, under guarantee, boxed including all leads, £30 worth of software, two new joysticks and £10 worth of books and magazines, £150. Tel: Leeds (0532) 604981 after 5 pm.

DRAGON 32, lots of software and utilities, worth £200. Sell for £120. Tel: 01-556 6091, ask for Mrs Vervigi.

DRAGON 32. Five highly imaginative games on a quality cassette plus original documentation including Pucmann, Invader Synthesiser, Duel and Colony, costing £3.50 inc p&p. Cheques/PO to A. J. Wass, 19 Fernwood, Marple Bridge SK6 5BE.

DRAGON GAMES for sale, 10 games all together at £50 or £5.50 each. Pair of joysticks for £15 (everything in very good condition), games include many top titles by Salamander. 061-797 6585.

DRAGON 32. Good condition guaranteed all leads new joysticks reliable recorder 4 Microdeal cassettes Berserk cartridges, worth £270, offers over £180. Telephone Dundee 67411 after 6 pm.

DRAGON 32. Still boxed 1 month old and new cassette recorder, 1 pair joysticks all leads and manual, 2 cassette games, cost £225, bargain only £180. Tel: Accrington 0254 391020.

DRAGON 32. £40 of software, manuals, lead, book and cassette player, £130. Tel: 0582 607969 after 6 pm.

DRAGON 32. £400 software, machine code cartridge, 1 joystick, 4 games, sell £90 ono. Barton 781147, Don Cambell.

DRAGON 32 + 3 cartridges, joysticks, cassette, s/w and books, £180. Tel: Fleet (Hants) 02514 20152.

DRAGON 32 + joysticks + dust cover + £160 top name software + 6 books, £180 or swap for 48K Spectrum Issue 2 + software. Tel: East Grinstead 0342 27072.

DRAGON 32, 3 months old, a pair of joysticks, dust cover, approx £50, 2 cartridges, £170 ono. 021-326 9501.

DRAGON FOR SALE, £135, no offers, with extras. Tel: 061-945 1269.

DRAGON 32, manual, joysticks, leads, plus £70+ of software including Ring of Darkness, Katerpillar, Planet Invasion plus £30+ of magazines, worth over £350, sell for £200 ono. Tel: 0792 401823.

DRAGON 32, cassette recorder, over 25 tapes including Donkey King, Katerpillar Attack, Hi-res cartridge, 51 x 24 screen, 2 joysticks, light pen, book, magazines, only £220 for quick sell. Tel: 01-703 7985.

DRAGON 32, boxed, with all leads, manuals, etc, book, £30 worth software, all Dragon User magazines, worth £220, sell £140. Ring 0704 68894.

DRAGON 32, under guarantee, boxed, including all leads, £30 worth of software, 2 new joysticks and £20 worth of books and mags, £150. Tel: Leeds 604981 after 5 pm.

DRAGON 32, complete with 20 software tapes (Arcade, Adventures, Home Finance), three cartridges (inc Chess), books, joystick, printer cable and Dragon User magazines, £210 ono. Phone 01-641 2285, Johnson.

DRAGON 32, very good condition, 3 joysticks, 3 books, over £220 worth of s/w, cost £450, sell for £210 ono. Tel: (0279) 815623.

Ataris for sale

ATARI VCS + 11 cartridges including Pacman, Asteroids, Space Invaders, two joysticks and paddles, £120 or exchange Vic20 + hardware and software. Tel: 0702 710246 ext 48 (day-time).

ATARI VCS plus four cartridges, including Space Invaders with joystick and paddles, will sell for £75 ono (or will swap for Spectrum). Tel: 051 220 0049.

ATARI VCS, 10 cartridges, excellent condition, worth £400. Sell for £130. Tel: 455 1042.

ATARI 400 48K, moving keyboard, program recorder, joystick, all manuals, PSU etc. 50 machine code games include most famous titles and others! £270 ono. Tel: 01-599 6946.

ATARI 800 48K with disc drive, 810, inc: Atari Basic, Microsoft Basic, Assembler Editor, Monkey Wrench, two arcade and adventure games + manuals. Sell for £570. Tel: 01-722 4570.

65 ATARI VCS CARTRIDGES between £8 and £10 inc: Missile Command, Asteroids. Tel: Bicester 242 408 (5-6 pm).

ATARI VCS + two paddles + two joysticks — games cartridges, £50. 01-568 7325.

ATARI VCS plus Pacman and Defender with Combat, joysticks, all for £50. Tel: Southend 710266 after 4 pm on weekdays.

ATARI, VCS and all the gear, plus nine cartridges and a dust cover, including Pacman, Space Invaders, Chopper Command and Asteroids, worth over £250, bargain at £95. Tel: Southend-on-Sea 232420.

ATARI VCS with Space Invaders and Combat cartridge, £50. Tel: 01-675 0797.

ATARI VIDEO COMPUTER SYSTEM plus six cartridges, including: Defender, Asteroids and Space Invaders. All boxed, £100 or nearest offer or will sell games separately. Tel: Penrith (Cumbria) 63518.

ATARI 400, Basic, Star Raiders, two joysticks and over £15 worth of books, only one month old. Sell for £160 ono, worth over £200. Tel: 01-656 3735 evenings only.

ATARI VCS. Good condition, five cartridges, £50 ono. Tel: 01-328 2075.

ATARI VCS. Paddles and joystick, nine cartridges, Asteroids, Space Invaders, £150. Tel: 01-452 4838.

ATARI 800 48K tape recorder, disk drive, £300 of software, as new would cost £950, accept £650. Tel: 021-550 9924.

ATARI VCS, plus joysticks, paddles, combat cartridge and manuals, excellent condition, still guaranteed, £50. Atari VCS tidy, two cartridge holders and dustcover, £7. Empire Strikes Back cartridge, £17. Phoenix cartridge, £17. The lot for £85 ono. Tel: Woking (04862) 70318.

ATARI 400 48K, 410 program recode, £150 of games, back-up cassette, still in boxes, with one Atari and quickshot joystick. Offers or swap for BBC. Tel: 01-550 0106 after 4 pm or swap for BBC.

ATARI VIDEO COMPUTER SYSTEM with three cartridges, Combat, Street Racer and Space Invaders. All boxed with full instructions. Very good condition, £75 ono. Tel: 0254 381335.

Wanted

WANTED PRINTER for BBC. Phone Maldon 869398.

SWAP. Atari 400 plus 16K, Basic, recorder, manual and software for Spectrum 48K plus bits or sell for £130. As new. Ideal for Christmas. Tel: Martin after 7 pm, Burgh Heath 57278.

SPECTRUM SOFTWARE SWAP, 3D Tanx, Arcadia Hobbit, Flight Simulation, Gulpman, Jetpac, Penetration, Centipede and many more. Tel: 01-789 5728.

WANTED. Faulty or damaged ZX Spectrum 48K or 16K. Tel: Abingdon 834613 after 5.30 pm.

WANTED. 16K Spectrum. Must be Model 1 plus PSU leads etc. No software needed. Tel: Rugby (0788) 60405, Mr. Shelley.

SWAP Dragon 32 for BBC Model B including £200 of software. Most popular titles, still under guarantee. Mint condition. Leads, joystick, manuals included. Tel: 01-370 5896.

WANTED. ZX Spectrum 48K software, printer if available. Tel: Chesham (0494) 772544.

SWAP OR SELL Oric-1 48K cassette recorder, joystick, interface, quickshot joystick, £50 software, printer voucher, worth £300. Very good condition, swap for Atari 600XL or sell for £200 ono. Tel: Melton Mowbray 60281.

SWAP ADVENTURELAND cartridge for any other in Scot Adams CB. Tel: (0698) 421 327, Hamilton.

SWAP SPECTRUM for Dragon software. Mostly interested in adventures, would like Mysterious Adventure series, but anything considered. Tel: 0392 833240.

AN ATARI 810 disk drive plus disk software. Tel: Dudley 53149 evenings.

WANTED BADLY. 16K/48K Spectrum with manuals, will pay £70 to £90 plus postage costs. Also wanted quality software. Send offers to Jan Erik Borge, Box 42, 3135 Torød, Norway.

SWAP Dragon 32 plus joysticks and software including: Frogger, Shuttle, The King and more also *Dragon User* magazines. Four months old, boxed, for 48K Spectrum with software (under guarantee).

WANTED. Diagrams and technical information on T199/4A add-ons. Also secondhand RS232, modules, cartridges, etc. Write: T. R. Freeman, 155 Albert Street, Fleet, Hants GU13 9RP.

For sale

SHARP MZ 80K built-in screen and tape recorder, £350 of software and manuals, user guide and program books and dust cover, for £295 ono. Tel: 01-455 6641, Golders Green, after 4.30 pm.

LYNX 48K, as new. Still under guarantee. Boxed with manuals, leads, demonstration tape and users magazines, £150. Tel: Wickford, Essex, 68701.

PHILIPS G7000 VIDEOGAME, 18 cartridges, dustcover. Good condition, value £360, sell £170 or NU cartridges separate, £8.50 each. Quest for the Rings, £18. Tel: Accrington 0254 396847.

LYNX SOFTWARE GAMES PACK III, plus IV, Adventure Quest etc., book plus two newsletters. Any reasonable offer over £10 accepted. Tel: Egham 33502 (Surrey), Private sale. Good condition.

FOR SALE OR SWAP. Spectrum software. Most well known titles, including Arcadia, Flight Simulator, etc. Tel: Lairg (Scotland) 0549 2113.

SELL VIDEOGENIC 16K, £250 worth of software, books and manuals, £200 ono. Contact: 49 Homefield Road, Pucklechurch, Bristol BS17 3QA. Tel: 027582-2145.

MICRO-PROFESSOR ONLY, £90. Brand new, only two months old. Tel: 01-351 2269 after 6 pm.

LYNX 48K, six months old, complete with compatible tape recorder, nine games tapes, associated books, newsletters and listings. Bargain at £175. Write to: 31 Irwell Place, Platt Bridge, Near Wigan WN2 5EF.

ARCADIA, 3D Tanx, £3; Time-gate Battlezone, £4; Hobbit, £9; Flight Simulation, £6; VU-3D, £7; magazines and books, 25p p&p. Write to: D. Appleton, 9 Coronation Road, High Bridge, Somerset. (Private sale).

ZX PRINTER. Original roll unfinished plus five rolls of paper. Improved spool and software to enable sideways print, £25. Tel: Bath 887155 during office hours.

WIRELESS WORLD MICRO PSICOMP 80 Z80 + number cruncher based, built by professional engineer from Robust + power tran kit, full paper work + news letters. Offers? Tel: 01-289 7219 (evenings).

INTELLIVISION. Boxed as new. Unwanted gift. Three free games. Hardly used. Bargain at £75 ono. Tel: Oswestry (0691) 656488.

CROMEMCO high resolution colour graphics system. Complete 760 X 340 Pixel system with graphics, software. New cost over £3,500. Offers around £2,000. Tel: Aberdeen (0224) 572933.

TRS-80 MODEL 1, level 2, Basic 48K, expansion interface, one disc drive, cassette, lots of software including: Scripsit, Edtasm, Zchess II, Nendos 80, etc. £400 ono. Tel: (07918) 6254.

DATA CASSETTE RECORDER CCR800 for Spectrum, Oric, etc. Very reliable, £18. Forth Manual, Winfield complete Forth book, Hampson tape version 2, £9. Tel: 0203 383212 or 0992 830248.

LYNX 48K MACHINE, four months old, hardly used, mint condition, manuals, introductory cassette, boxed as new, cost £225, sell for £190 ono. Tel: 01-626 1500 (office hours), extension 2017.

TI94A, as new, £75. Chess and personal records cartridges, £20 each. TI-55/II LCD programmable calculator, £20. Chess Challenger 7 chess computer, £35. 20 Callerton Close, Ashington, Northumberland NE63 9QT.

INTELLIVISION GAME plus six games, £130. Tel: 01-876 0095.

OHIO SUPERBOARD, faulty, hence £40 or offers. 8086 development system with intel monitor eproms etc, offers. Hugh Bridge, 363 Kennington Lane, Vauxhall, London SE11 5QY. Tel: 01-735 1862.

TEXAS INSTRUMENT P199 home computer games module: Barsc, Chess, Munchman, £20 ono. Hardly used. Tel: 01-558 0767 (evenings).

GEMINI GALAXY 2 800K DISK. As new, £200. Tel: (0753) 882399.

SHARP MZ80K plus printer, £600. Tel: (0753) 882399.

ASTRO CLASH for the unexpanded Vic20, good sound effects and graphics, for only £1.20 a copy inclusive of p&p. Send to 32 Grange Road, Strood, Kent.

SHARP MZ80, built-in screen, cassette recorder, Basic tapes, manual, Forth tapes and programming books plus £250 software for sale, £350. Tel: 01-455 6641 after 4 pm.

COLEVISION ZAXXON CARTRIDGE. Offers to Alistair, Bedford 212 646 after 5 pm.

ORIC-1 48K complete with manual, P.S.U., all leads, Forth cassette and manual, assembler/disassembler and documentation plus a couple of games, £130. Tel: Essex (0245) 50432.

CBM 64 SOFTWARE, S/H private sale. At least 50 per cent off list. Tel: Ged on Warrington 31288 ext 231 between 12 pm and 12.30 any Monday.

VIC20 plus cassette, Programmer's Aid cartridge, machine code cartridge, 16K plus 3K Ram cartridges, joystick, books and many magazines, £150 ono. Tel: 0634 813196.

FULLER SPEECH SYNTHESISER. Excellent condition, £30. Selling because buying a microdrive. Tel: Wolverhampton 737179 after 4.30 pm.

ORIC 8k Rampack, mint condition, boxed. Swap for software or sell £15. Tel: 041-778 5184 evenings/weekend.

NEUBRAIN COMPUTER, AD model, built-in display, manual, printer, leads, games, cassette and beginners guide. Virtually unused, £160 ono. Tel: 021-520 2617.

8271 DISC controller chip wanted for BBC, £15 paid. Tel: Peter on Uppminster 24385.

PHILIPS G7000 COMPUTER, as new, with six games including computer pack, £65 ono. Tel: Tottenham 801-5580.

SWAP PORTASS 3 1/2 in. centre lathe, C/W motor, single phase, 3-jaw, 4-jaw chucks for Dragon data disc drive. Gray, 178 Grange Road, Letchworth, Herts.

ELEVERTHALLS program 6809, will buy or swap for Dragon software. Tel: Richmond 811611.

SWAP VIC Super Expander cartridge for two games cartridges must be (Moneywars, Cosmic, Jailbreak, Manangerie). Tel: Stevenage (0438) 811634 after 7 pm.

SPECTRUM 16K/48K. Tel: Langford (0458) 020130.

EXCHANGE OF BUY ZX81 software. Send list. 65 Grassdale View, Sheffield S12 4LZ.

BBC SOFTWARE, 50 programs, a range to choose from. Ring for details. Tel: 574 2576.

BBC SOFTWARE, Acorn Soft originals and many others, £6 tapes all £4 each, must sell. Tel: 051-420 3462.

BBC MODEL A (32K) plus printer port plus joysticks, £350 ono. Epson MX80 FT III hi-res printer, £350 ono (less 10 per cent for both). Tel: Halifax 41048.

BBC MODEL B. Still boxed, large amount of software plus joysticks and magazines etc, £700 ono. Tel: 01-575 0640 after 6 pm.

BBC MODEL B 1.2 O/S, guaranteed. Bought September 1983, software available, £360. Tel: (0753) 73099

TNT SOFTWARE



CENTIMUNCH

Special introduction offer
£5.95 (inc P&P and VAT)
FOR THE 48K SPECTRUM

An original game with on-screen scoring plus Hi-Score. Watch out for the Spider, mind the Bees don't confuse. Remember eat all your veg, a Super Carrot can improve your eyesight — now you can see the gate. Careful round those Rocks. Can you survive a full 12 months in a garden like this?

DEALER ENQUIRIES WELCOME —
RING 0229 27324

Please send Cheques or P/Os to:
**T.N.T. Software, Dept B
Melton House, Lindal
Ulverston, Cumbria**

I ENCLOSE £.....
NAME
ADDRESS
.....
.....

ISL **48K SPECTRUM** ISL

SPLAT!



48K SPECTRUM CHALLENGE
FROM INCENTIVE SOFTWARE LTD

SPLAT!
ARCADE

ONE OF THE MOST ORIGINAL
AND COMPELLING ARCADE
GAMES EVER PRODUCED!
STARRING ZIPPY!!

"SPLAT! is one of the most
addictive games I have ever played
on the 48K SPECTRUM, It is
certainly the most original"
Computer & Video Games

NOW AVAILABLE FROM WH SMITH
AND BOOTS.

N001 £5.50

**MOUNTAINS
OF KET**
ADVENTURE

A MONSTER OF AN ADVENTURE
PROGRAM! COMBAT, INTER-
ACTIVE BEINGS, MONETARY
SYSTEM, MAGIC, EDGAR, SAVE/
LOAD FACILITY PLUS MANY
OTHER FEATURES.

As well as being a fast ingenious
compelling adventure in itself-the
Mountains of Ket is the first of a 3
part series that builds into a
mammoth adventurers challenge.

Incentive: It could be advantageous
if you achieve 100%!!

N002 £5.50



1984

A GAME OF
GOVERNMENT MANAGEMENT



1984

THE GAME OF
ECONOMIC SURVIVAL

THE BRITISH ECONOMY WITH YOU
AT THE CONTROLS! WHAT SORT
OF CHANCELLOR WOULD YOU
MAKE WITH SEVERAL BILLION
POUNDS TO SPEND & FIVE
YEARS TO THE NEXT GENERAL
ELECTION? GRAPHIC DISPLAYS,
HISTOGRAMS & AN ANNUAL
PERFORMANCE RATING ARE ALL
INCLUDED TO SHOW HOW YOU
ARE DOING. HOW MANY YEARS
WILL YOU LAST?

FREE INSIDE: Pocket Guide to
Running Britain!!

N003 £5.50

All programs run in the 48K ZX SPECTRUM and are available from all good computer shops. In case of difficulty please order direct using the coupon below.

Please send me (tick box(es) required)
SPLAT MOUNTAINS OF KET 1984

All at £5.50 each (inclusive of VAT and 1st class postage)
I enclose cheque / P. O. for £ or debit my Access Account No.

.....

Name

Address

ISL INCENTIVE SOFTWARE LTD., 54 London Street,
Reading RG1 4SQ. Tel: Reading (0734) 591678

NEW RELEASES

ELABORATE

GATEWAY TO THE SKIES



Gateway To The Skies is an elaborate text adventure for the BBC with 32K. It is so vast it will not fit into the machine and so has to be loaded in two parts.

The program has single key entry of all movement commands, but adopts the standard Verb/Noun format for all other instructions.

The basic point of the adventure is to search for hidden golden artefacts and take them to the palace of King Zalea. You can save the game at any stage and you'll probably need to — it sounds like a long one. A Spectrum version is also available.

Program *Gateway To The Skies*
Price £8.00 (Spectrum £6.95)
Micro BBC (32K)/Spectrum 48K
Supplier Solar Soft
5 Westmorland Drive
Camberley
Surrey GU15 1EW

CORRUPT

Richard Shepherd Software has been one of the most successful games houses specialising in adventures for the Spectrum.

The company has now released its first program for the Commodore 64. The game *Ship of the Line* is an adaptation of the program of the same name on the Spectrum.

You assume the role of an unashamedly corrupt, sea captain in charge of a Royal Navy warship, in the 17th century. You must fight ferocious sea battles to win treasure with

which to bribe your way to the top.

Succeeding in the game is a matter of careful planning and luck, will you have enough rations to feed your mutinous crew? Will your ammunition run out?

Program *Ship of the Line*
Price £6.50
Micro Commodore 64
Supplier Richard Shepherd Software
Elm House
23-25 Elmshott Lane
Cippenham
Slough
Berks

MAGIC

Compilers are wonderful things. The biggest problem with Basic is that it is simply too slow to produce the kind of exciting games that you want to play repeatedly.

Machine code on the other hand is fiendishly difficult (well I think so anyway). A compiler though, magically turns a Basic program into machine code while you sit back and watch.

The first compiler I've seen for the BBC B has just been issued by Park Software. If it all sounds a bit too good to be true, well, as with all compilers, there are limitations.

The maximum program length is 8K and only 300 program lines are allowed. Similarly, you are limited to 26 variables and 30 procedures. Nevertheless, with care, most things are possible and you could find the compiler very useful.

Program *Compiler*
Price £14.95
Micro BBC B (1,2 OS, A with 32K)
Supplier Park Software
26 Romilly Park Road
Barry
South Glamorgan
CF6 8RQ

3D SCRAMBLE

Zaxxon is the first version I've seen on the Spectrum of the impressive *Zaxxon* arcade game.

Although plot-wise the format is similar to *Scramble* — break through the enemies defences to reach and destroy some ultimate objective — the

game achieved its reputation because of the 3D presentation of the attack.

Your aircraft, complete with shadow, is seen from above and to the side. The enemy defences are seen from a similar perspective. The way the screen scrolls diagonally, adds to the sense of pace and drama in the game.

Program *Zaxxon*
Price £5.50
Micro Spectrum 48K
Supplier Starzone Software
74 Wallingford Road
Shillingford
Oxford OX9 8HB

FUZZY



Let me be honest. I have always thought that Dragon software was appalling — everything I saw was overpriced and dull, and incidentally, usually written in Basic.

However, things are looking up. After the excellent *Ugh* by Softek, we have *Pub Crawl* by B&H Software and it's another superb Dragon game.

The screen displays a layout of various pubs and a hamburger joint. You leave home trying to visit as many pubs as you can, downing a swift pint in each. Naturally after a while things start to get a little fuzzy and with all that traffic about you'd best grab a burger to line your stomach.

Later stages of the game bring on police cars that dash about like something from the Sweeney — can you drink all the pints and make it back home?

The game is entirely in machine code and it shows;

the action is very fast and the sound effects are amusing.

Program *Pub Crawl*
Price £6.95
Micro Dragon 32
Supplier B&H Software
208 King Street
Cottingham
Hull

MS RIGHT?

Lonely? Spent too much time sitting alone in front of your tv? Looking for Miss Right (or Mr Right) — now there's no need to switch off the tv and rush madly into dozens of meaningless relationships, use your computer to plan ahead.

Matchmaker is the program you need, roughly equivalent to the systems used by professional companies, it will store 100 people's replies to a series of 25 questions and, according to their answers, match them.

Using the computer's rating system you will be able to find the person who most likes what you like, etc. But what will you have to talk about?

Program *Matchmaker*
Price £9.99
Micro Commodore 64
Supplier Commodore
675 Ajax Avenue
Slough Trading Estate
Slough
Berks SL1 4BG

SKILLS

Games Graphics and Sounds is a book intended to be both a general guide to what kinds of game are available and specific information on how some of the effects are programmed.

Along with the types of game, the skills required for each are discussed and there are various colour illustrations.

Also included is a guide to what to buy for games playing and a number of programs to type in. Given the colour illustrations it looks reasonable value at £4.95.

Book *Games Graphics and Sounds*
Price £4.95
Micro General
Supplier Francis Lincoln
Apollo Works
5 Charlton King's Road
London NW5 2SB

DANGEROUS



Terminal Software whose *Pinball* achieved wonders in 3K on the Vic has entered the competitive world of Spectrum programs.

Both of its new releases are graphics adventures — *Vampire Village* and *Space Island*.

Space Island gives you an android to control — the only equipment you have been able to get down to the planet Zyro from your spaceship orbiting the planet. You must use your android to locate the origin of a dangerous time distortion on the planet.

Movement and instructions to the android are all by single key presses although there are many more options than usual. The only graphics I managed to see of the game before my android drowned was the map of the planet and this was well done. The packaging, too, is very robust and appealing. Recommended.

Program *Space Island*
Price £6.95
Micro Spectrum 48K
Supplier Terminal Software
28 Church Lane
Prestwich
Manchester M2 7LW

LADDERS

More praise for Dragon software. This time for *Castle Attack*, a multi-screen arcade game with many features.

The first section is a bit like *Apple Panic* although very well done — you must run up a number of ladders on the walls of a castle to reach three keys, but you must get them in the right order.

The problem is, various bar-

rels and arrows are hurtling across the screen — you can avoid them but your time is limited. That, though, is only part one.

In the second section you play a variant of Mastermind with the life of a beautiful princess as the stake. The knife suspended above her draws nearer as you fumble at the logic of a four shape code. As ever, everything gets more and more difficult as you go along. Fine stuff.

Program *Castle Attack*
Price £6.50
Micro Dragon 32
Supplier M & D Systems
39 Sheridan Road
Frimley
Surrey GU16 5DU

SUPERB



Phoenix Software whose double package *Death Mines of Sirius I* thought very good value for money have now released their first Vic game in the double cassette arcade/adventure series.

I can say that the action part of this package called *Four Gates To Freedom* is superb. It's a sophisticated version of *Breakout* where you fire at the walls with lasers. I've seen nothing faster, noisier or more addictive outside of some of the Llamasoft games.

Mastering the action game (a seemingly impossible task) will give you the start up code to the adventure.

The task then is to release the crew of a star cruiser who are held in suspended animation somewhere in the mysterious catacombs of Xzinos. It has all the standard adventure

features and the package is highly recommended.

Program *Four Gates To Freedom*
Price £9.95
Micro Vic20 (+8K)
Supplier Phoenix Software
Spangles House
116 Marsh Road
Pinner
Middlesex

OPPRESSED

Red Shift has made the world of war-game orientated computer programs its own.

The latest addition to the range is *Nebula* for the 48K Spectrum. It has the classic scenario of expansionist emperors forcing oppressed peoples to battle it out for territory and glory.

I must admit that in the past I have expressed doubt with the manuals that accompany these sort of epic games — mainly because I can't understand them. On this occasion though, I can happily report that the manual is (a) quite short and (b) fairly easy to understand, so it may be that *Nebula* could be an introduction to the subject.

Program *Nebula*
Price £9.95
Micro Spectrum 48K
Supplier Red Shift
12c Manor Road
London N16 5SA

MYSTERY

The one place where the Spectrum (16K) has no advantage over the ZX81 16K is in running text adventures. In fact, the ZX81 has more available memory.

So it's good to see that adventures are still being issued for the machine — the most recent is *Don't Look Now*.

You explore a series of caves meeting peculiar strangers who will probably want to kill you and finding objects whose function is quite likely to remain a mystery.

There is no ultimate end to the game and you must simply use your ingenuity to get as far as you can.

Program *Don't Look Now*
Price £4.95
Micro ZX81 (16K)
Supplier MDD Whitehouse
7 Dornie Close

Stewarton
Kilmarnock
Ayrshire KA3 3HE

WELCOME

commodore 64
mastercode assembler



The Commodore 64 is a very powerful machine, but important utilities like machine code programming tools are still relatively scarce.

At the moment there isn't much choice for the 64 owner wanting to venture into assembly language; assembler and disassembler programs are few and far between.

For this reason the *Commodore 64 Mastercode Assembler* should be welcome news, combining as it does a machine code monitor, disassembler, file editor and assembler in one package.

There's no point in trying to list all the features in a short piece like this, but I can say that the manual is clearly written and the program is very user friendly. I'd better add that it's by Sunshine (which is us) and was written by book authors David Lawrence and Mark England.

Program *Commodore 64 Mastercode Assembler*
Price £14.95
Micro Commodore 64
Supplier Sunshine Books
12-13 Little Newport St
London WC2R 3LD

New Releases is designed to let people know what software is coming on to the market. If you have a new game or utility which you are about to release send a copy and accompanying details to: New Releases, Popular Computing Weekly, 12-13 Little Newport Street, London WC2R 3LD.

This Week

Program	Type	Micro	Price	Supplier
A 10 Bomber	Arc	Colour Genie	£8.00	Ipswich
Amazing Ollie	Ed	BBC B	£6.95	Storm
Armageddon	Arc	Commodore 64	£9.95	Visions
Assembler/Disassembler	U	Commodore 64	£9.50	Micro Video
Banana Drama	Arc	Commodore 64	£9.95	Visions
Bandits	Arc	Electron	£7.95	Program Power
Battle Brick	Arc	Lynx	£4.50	Bus Tech
Big Time	Ad	Spectrum	£4.50	Mushroomsoft
Cassette 10	Ed	BBC B	£11.85	Schoolsoft
Centimunch	Arc	Spectrum	£5.95	TNT
Chess	S	Electron	£7.95	Program Power
Croaker	Arc	Electron	£7.95	Program Power
Dare Devil Dennis	Arc	BBC	£7.95	Visions
Deathchase	Arc	Spectrum	£6.95	Micromega
Dodge City	Arc/Ad	Spectrum	£9.95	Phoenix
Double Trouble	Arc	Spectrum	£5.90	Starlite
Drone War	Arc	Spectrum	£4.95	Enigma
Espionage	Ad	Dragon 32	£4.95	Exodus
Felix and the Fruit Monsters	Arc	Electron	£7.95	Program Power
Felix in the Factory	Arc	Electron	£7.95	Program Power
Fireflash	Arc	Spectrum	£6.95	Abacus
Fool's Gold	Ad	Commodore	£6.99	Romik
Galactic Warriors	Arc	Spectrum	£6.95	Abacus
Geniepede	Arc	Colour Genie	£8.00	Ipswich
Golden Apple of Zeus	Ad	Vic20	£6.99	Romik
Goodness Gracious	Arc	Commodore	£6.95	Beyond
Graphics Package	Ut	Spectrum	£4.50	Dream
Gusher	Arc	Commodore 64	£9.95	Visions
Heist	Arc	BBC B	£6.95	Softspot
Helpline	Ed	Lynx	£4.50	Bus Tech
Hobbit	Ad	BBC B	£14.95	Melbourne
Hopper	Arc	Spectrum	£6.95	PSS
I Do	U	BBC/Electr	£12.65	Acornsoft
Invaders	Arc	Lynx	£7.00	Bus Tech
Invoicing	U	Dragon 32	£24.95	Micro Bus
Jumping John	Arc	Lynx	£7.00	Bus Tech
Krazy Kong	Arc	Spectrum	£6.95	PSS
Light Pen Editor	U	Commodore 64	£10.50	Micro Video
Lynx Muncher	Arc	Lynx	£4.50	Bus Tech
Martian Rescue	Arc	Colour Genie	£8.00	Ipswich
Minfield	Arc	Lynx	£4.50	Bus Tech
Moonraider	Arc	Electron	£7.95	Program Power
Proteus	Arc	Spectrum	£6.95	Abacus
Rapedes	Arc	Spectrum	£5.95	Visions
Roborun	Arc	Lynx	£6.00	Bus Tech
Sketchpad	Ed	BBC B	£6.95	Storm
Snooker	S	BBC	£8.95	Visions
Snooker	S	Commodore 64	£8.95	Visions
Snooker	S	Vic20	£8.95	Visions
Star Warrior	Arc	Spectrum	£6.95	Visions
Starclash	Arc	Spectrum	£6.95	Micromega
Stock Control	U	Dragon 32	£49.95	Micro Bus
Surround	Arc	Lynx	£4.50	Bus Tech
Swoop	Arc	Electron	£7.95	Program Power
Sword Of Hrakel	Ad	Vic20	£6.99	Romik
Tank Battle	Arc	Jupiter	£4.95	Plasma
The Dating Game	U	BBC/Electron	£12.65	Acornsoft
The Shaky Game	Arc	Spectrum	£8.00	Epic
Tombs of Xelops	Ad	Commodore 64	£6.99	Romik

Book Ends

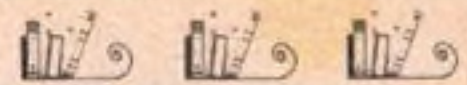

POOR ORIC

A nice, undemanding idea, to fill a small gap in a computer owner's stocking, this Christmas is *Computing: A Bug's Eye View* by Shiva.

It's a neat little book containing nothing but cartoons on a computing theme, all featuring the bizarre bugs and insects created by Cosgrove.

Most of the jokes are of the groan, groan kind — Hamlet bug looking over an Oric with a sword through it says (you can see it coming, can't you) "Alas, poor Oric". Probably not good for much more than a couple of hours read, but at £2.95 perhaps that doesn't really matter.

Book	<i>Computing: A Bug's Eye View</i>
Price	£2.95
Micro	General
Supplier	Shiva Publishing 4 Church Lane Nantwich Cheshire CW5 5RQ

VIOLENCE

Games of death, destruction and other wanton violence abound in *Tim Hartnell's Giant Book of Spectrum Games*.

Programs with names like *Suicide* and *Nuclear Fallout* suggest this might not be the book to ask your aged granny to buy for you as a Christmas present.

Having said that though, I should add that most of the games look like they might actually be worth your while typing them in.

The book is published by Fontana which means it should be very widely available and at £3.95 it looks good value.

Book	<i>Tim Hartnell's Giant Book of Spectrum Games</i>
Price	£3.95
Micro	Spectrum 16/48K
Supplier	Fontana Paperbacks 8 Grafton Street London W1X 3LA

Transistor's Revenge	Arc	BBC B	£6.95	Softspot
Transylvanian Tower	Ad	Dragon 32	£6.95	Richard Shepherd
Up Periscope	Arc	Dragon	£6.95	Beyond
White Crystal	Arc	Dragon 32	£6.99	Romik
Word Feud	Arc	Commodore 64	£7.95	Audiogenic
Wordsearch	Arc	Lynx	£6.00	Bus Tech
Zombie Panic	Arc	Lynx	£4.50	Bus Tech
Zorgon's Kingdom	Arc	Vic20	£6.99	Romik

Key: Ad — adventure/Arc — arcade/Ed — education/S — strategy-simulation/Ut — utility

This Week is a new section that covers all the new software coming on to the home micro market each week. All suppliers should send details of their new programs to: This Week, Popular Computing Weekly, 12-13 Little Newport Street, London WC2R 3LD.

Top 10

BBC*	
1 (1) Planetoids	(Acornsoft)
2 (3) Rocket Raid	(Acornsoft)
3 (2) Hopper	(Acornsoft)
4 (4) Swoop	(Program Power)
5 (7) Meteors	(Acornsoft)
6 (5) Monsters	(Acornsoft)
7 (8) Alien Swirl	(Program Power)
8 (—) Missile Base	(Acornsoft)
9 (10) Countdown to Doom	(Program Power)
10 (—) Feasibility Experiment	(Digital Fantasia)

*All Model B.
(Figures compiled by Micro Management, Ipswich 0473 59181)

Top 10

ZX81*	
1 (1) OS Scramble	(Quicksilva)
2 (4) 1K Chess	(Artic)†
3 (—) Fantasy Games	(Psion)
4 (5) Sabotage	(Psion)
5 (—) Espionage	(Psion)
6 (6) Chess	(Psion)
7 (7) Asteroids	(Quicksilva)
8 (—) Space Raiders	(Psion)
9 (2) Defender	(Quicksilva)
10 (8) Football Manager	(Addictive Games)

*All run in 16K except where shown. †1K.
(Figures compiled by Boots & Co, London)

Top 10

Dragon	
1 (1) Frogger	(Microdeal)
2 (3) Mined Out	(Quicksilva)
3 (—) Cuthbert in the Jungle	(Microdeal)
4 (10) The King	(Microdeal)
5 (—) Ring of Darkness	(Wintersoft)
6 (6) Champions	(Peaksoft)
7 (—) Pettigrew's Diary	(Shards)
8 (4) Drone	(Cable)
9 (—) Dragonfly II	(Hewson)
10 (7) Empire	(Shards)

(Figures compiled by Boots & Co, London)

Top 10

Vic20	
1 (—) Wizard and the Princess	(Melbourne House)
2 (3) Wacky Waiters	(Imagine)
3 (4) Panic	(BugByte)
4 (5) Catchna Snatcha	(Imagine)
5 (7) Matrix	(Liamssoft)
6 (1) Arcadia	(Imagine)
7 (—) Amok	(Audiogenic)
8 (—) Bewitched	(Imagine)
9 (2) Skyhawk	(Quicksilva)
10 (8) Frantic	(Imagine)

(Figures compiled by Boots & Co, London)

Atari	
1 (1) Zaxxon	(Datsoft)
2 (2) Miner 2049'er	(Big Five)*
3 (—) Preppie	(Adventure International)
4 (—) Zork II	(Infocom)†
5 (6) Meteors	(Acornsoft)
6 (—) Witness	(Intacom)†
7 (—) Jump'n Junior	(Apyx)*
8 (—) Planet Fall	(Intacom)†
9 (—) Savage Pond	(Starcade)
10 (—) The Blade of Blackpoole	(Sirius)‡

*Cartridge. †32K cassette. ‡48K disc.
(Figures compiled by Calisto Computers, Birmingham 021-632 6458)

Books	
1 (1) Advanced User Guide for the BBC Micro, <i>Bray, Dickens and Holmes</i>	(Cambridge Micro Centre)
2 (6) Commodore 64 Programmer's Reference Guide, <i>Commodore</i>	(Commodore)
3 (2) 30 Hour Basic, <i>Prigmore</i>	(NEC)
4 (3) Supercharge Your Spectrum, <i>Webb</i>	(Melbourne House)
5 (7) One Hundred Programs for the BBC Micro, <i>Gordon</i>	(Prentice-Hall)
6 (—) Spectrum Hardware Manual, <i>Dickens</i>	(Melbourne House)
7 (10) Assembly Language Programming for the BBC Micro, <i>Birbaum</i>	(Macmillan)
8 (—) BBC Micro — an expert guide, <i>James</i>	(Granada)
9 (—) Using the 64, <i>Gerrard</i>	(Duckworth)
10 (8) Anatomy of the Dragon, <i>James</i>	(Sigma)

(Figures compiled by Watford Technical Books, Watford 0923 23324 Prestel 26824)
(Last week's position in brackets)

Spectrum	
1 (2) 3D Ant Attack	(Quicksilva)
2 (—) Harrier Attack	(Durrall)
3 (3) Lunar Jetman	(Ultimate)
4 (—) Jet Pac	(Ultimate)
5 (—) Bugaboo	(Quicksilva)
6 (1) Flight Simulation	(Psion)
7 (—) Maziacs	(DK'Tronics)
8 (4) Zoom	(Imagine)
9 (7) Kong	(Ocean)
10 (—) Manic Miner	(Bug Byte)

(Figures compiled by W H Smith and Sons, London)

Ziggurat



Advertising Standards

When we just cannot get our arcade scores any higher, or figure out how to get past that fierce lavatory seat with one hand tied behind our back, the cares of the world on our shoulders, and that Pesky Pie-Person giving us clues all the time, computer-exhaustion finally takes hold.

We desperately want to relax, so we pull out the computer lead, push the aerial back in and think of a number between one and four. This helps to sooth our tattered nerves, until the commercial "break" arrives and a large grey elephant or a superannuated Scouse cynic appears to insult our intelligence. In desperation we grab the *Radio* and *TV Times* to look for an alternative, but once again those corny adverts leer out at us from the pages. We turn off in disgust and pick up a newspaper, but there's no getting away from it as everyone from the biggest hypermarket to the local greengrocer seems to be claiming that "you can't buy it cheaper elsewhere".

We are not sure of other people's reactions, but the current state of computer promotion certainly has us oscillating between hysterical laughter and sheer horror. We know that, to the entrepreneur, computers are "for selling, not for buying" and that all advertisers are given to hyperbole, but surely there must be a limit somewhere! If you regularly read *PCW* (and even *Ziggurat!*) you probably already have a micro of some sort (or at least have tinkered with your friend's) so you presumably have

some idea about what the important features are in a home micro.

On the other hand, it seems that computer promotion has sunk to the depths of the car industry, where the whole point seems to be to extoll the importance of trivialities and to avoid the really important issues at all costs. So, who are they fooling?

Regrettably, the answer is usually the first time buyer who thinks Ram is a male goat and that Rom wasn't built in a day.

As Christmas approaches, and the stampede intensifies, all reason seems to vanish as Mum and Dad know that little Johnny (or Jenny) will be inconsolable if Santa doesn't deliver the goods. So, how do they choose and where do they go?

The answer usually lies in the relative importance of the bank-balance, "keeping up with the Joneses", and what name has been subliminally impressed on their mind.

Although every Tom, Dick and Harry now sells computers and every store seems to contain a "computer shop", it is regrettably true, that the demand for qualified salespersons far outstrips the supply (one of the funniest sights this week was the pathetic "computer sales manager" of a local department store trying to pretend to a "real" dealer that he was a potential purchaser so that he could glean some information on the products to pass on).

Of course, Darwin might argue that natural selection will ensure the survival of the fittest, but the harsh world of reality seems to select more on the basis of brute force than technical excellence. What seems to count most in this market place is how much you can afford to spend on promotion, rather than how good your product is (or even more important, how good the back-up will be).

The last few months have seen the death-throes of a number of companies, yet more have retired in haste to lick their wounds, and the writing is on the wall for several more. After Christmas we are certain that there will be a lot of wailing and gnashing of teeth as many of the big stores wrap up their chips, get out the holiday brochures, and relegate computers to the store cupboard, leaving too many customers to find out for themselves that they have bought a pig in a poke.

Keith and Steven Brain

Puzzle

Egyptian code

Puzzle No 83



This interesting fragment of an ancient Egyptian clay tablet was recently unearthed by that eminent archaeological duo — Drs Diggert and Trowell. It is thought that it represents a multiplication sum but, unless it is shown that it is possible to satisfactorily substitute digits for the symbols shown, this theory cannot be proved. There is evidence that the sum is in decimal notation and the bird symbol was used to represent the digit '3'.

Can you make the archaeological breakthrough and confirm the theory?

Solution to Puzzle No 78

The program uses three variables, *N*, the number of the highest double of successively larger domino series, *P*, the number of pieces in the set and, *T*, the total number of spots.

Subsequent orders of sets, are calculated in the *For/Next* loop (Lines 40 to 70), and the program stops when the total number of spots exceeds 1983, the present date.

```
10 LET N = 0 0 LET P = 0 30 LET T = 0 40 FOR A =
N TO 0 STEP - 1 50 LET T = T + A + N 60 LET P =
P + 1 70 NEXT A 80 PRINT N, " ", P, " ", T 90 IF T >
1983 THEN STOP 100 LET N = N + 1 110 GOTO 40
```

The program gives the solution of a set with 120 pieces — up to a double-fourteen, giving a total of 1680 spots, the year required by the puzzle. The previous set, up to a double-thirteen, can be ruled out because of the number of spots. This gives the year as 1395 and it seems too close to the date of the set itself, manufactured by "distant" ancestors in the 14th century.

Winner of Puzzle No 78

The winner is: E Oakley, South Road, Northfield, Birmingham, who receives £10.



ADVERTISEMENT

ORDER FORM

TO AUTOMATA U.K. LTD: "PLEASE RUSH ME THE FOLLOWING CASSETTES"

- "MY NAME IS UNCLE GROUCHO YOU WIN A FAT CIGAR" for 48K ZX SPECTRUM £10
- "MORRIS MEETS THE BIKERS" for any ZX SPECTRUM £6
- "GO TO JAIL" for 48K ZX SPECTRUM £6
- "YAKZEE" for 48K ZX SPECTRUM plus DRAGON 32 £5
- "PIMANIA" for 48K ZX SPECTRUM £10
- "PIMANIA" for B.B.C. 32K £10
- "PIMANIA" for DRAGON 32 £10

"THE PIMAN'S CHRISTMAS STOCKING" (including PiMan's 1984 Kartoan Kalendar, PiMan's own C20 Blank Computer Cassette, plus the truly amazing "PIMAN'S GREATEST HITS" stereo L.P.) £5

I ENCLOSE THE RIGHT MONEY, TOTAL £ or please charge my ACCESS/EURO/MASTERCARD

CARD NUMBER

MY SIGNATURE

MY NAME

MY ADDRESS

POST CODE

send to AUTOMATA U.K. LTD., 27 HIGHLAND ROAD, PORTSMOUTH, PO49DA. HANTS., ENGLAND. Telephone (0705) 735242 Mail Order Service.

ALL PRICES INCLUSIVE! NO EXTRAS! Please leave space below blank.

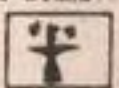

WE CELEBRATE our cartoon strip's successful tour of the Orient by releasing the gang's new program "YAKZEE" the authoratitive user-friendly computer version of the lateral-thinking dice game. It runs on the Spectrum 48K or the Dagon 32 (keep the Chinese verbals for the comic strip, OR ELSE!) and is part of our mission to spread joy and happiness across the planet with non-violent and genuine entertainment. Pray it ... whoops' Play it.....!

CALLING ALL "PIMANIACS" who can't get enough of a good thing: "THE PIMAN'S CHRISTMAS STOCKING" is out now!!! and it only costs a Fiver!! It includes "THE PIMAN'S GREATEST HITS" stereo L.P. cassette with vocals by our very own Lady Clair Sinclive, The PiMan Gerry and the Atrics, and even Lurch the Office Parrot ... at least we think he's a parrot?! sings a song or two. Featuring "Leader of the Pac", "Video Nasty", "Bit of a Cult!" "Computer Alphabet", "Groucho Extended", "Crummy Song" "Pompey Rock", "Angel" "PiBalled Blues", "Country Musac", "Donkey Hotay" "Pimania ... the very long one



-PLUS-

THE PIMAN'S OWN C20 COMPUTER CASSETTE, a top quality blank tape, for saving your own programs, or your PIMANIA progress. (And if you pirate anything we'll send Lurch along to sort you out!)

-PLUS-

"THE PIMAN'S 1984 KARTOON KALENDAR" the official version, A4 size, hanging book format, featuring the insane world of the PiMan and his pals, as created by our resident krummy kartoanist, the amazingly underpaid Mr. Evans.....

SEE US AT THE

9th  **ZX MICROFAIR**

Saturday / Sunday
December 3-4
Alexandra Palace

UNCLE GROUCHO AND THE PIMAN TO STAR IN T.V. SHOW

read all about it here next week ! ! ! ! !

MEANWHILE, BACK AT THE AUTOMATA COMIC STRIP..

PANEL 1: THE PI-BAND HAVE BEEN SHIPPED TO NANKING, CHINA, TO ENTERTAIN CHINESE PIMANIACS WITH SONGS FROM "PIMAN'S GREATEST HITS," AND AFTER AN EXHAUSTING CONCERT ON A MOUNTAIN TOP... HYSTERIA!

PANEL 2: WELL, THEY SEEM TO LIKE US... BUT IF THEY GET UP HERE, THEY'RE GOING TO TEAR US TO LITTLE TINY TITCHY BITS!!

PANEL 3: MAYBE WE CAN FIGHT 'EM OFF! ARE THERE MANY? LET ME SEE... 67... 68... ABOUT 69,482,974 IF YOU COUNT THE UNARMED ONES - OTHERWISE 69,482,961!

PANEL 4: AHH EXCUSE LUDE INTLUSSION... BUT CAN HERP PASTY BLITS OUT OF EFFRUENT!

PANEL 5: I TAKE YOU ON SECLT LOUVE AWAY FROM HYSTELICAL MOB - YOU WILL MEET FAMOUS GULU, WHO WILL TERR YOU MEANING OF RIFE, IF...

PANEL 6: CRUMBS! YOU CAN ACTUALLY SEE THAT GUY'S AURA!

PANEL 7: EXCUSE - NOT ACTUARRY AULA OF GULU...

PANEL 8: ...BUT OF TV MONITOR! GULU PRAYING MOLLIS & THE BIKERS!

PANEL 9: YES! OH, MOST FUN! NOW HAVE GAME FOR ENGRISH VISITORS!

PANEL 10: YES... THE ANCIENT OLIENTAR GAME OF YAKZEE... VELY ENTERTAINING - HIGHLY ENGLISSING - NOW ON COMPUTER SOFTWARE!

PANEL 11: IF WE SHOW THIS TO PENFOLD AND CROUCHER THEY MAY START BEING NICE TO US!

PANEL 12: GULU! TAKE US TO ENGLAND, YAK, AND WE'LL CUT YOU IN!

PANEL 13: A NEW GAME? FOR A COMPUTER?

PANEL 14: MONEY TALKS. OKAY, FERRAS!

PANEL 15: YET ANOTHER NON-VIOLENT GAME FOR AUTOMATA U.K!