

40, Route Rd

Only 50p.

POPULAR **Computing** WEEKLY

9-15 October 1986

Vol 5 No 41

Amstrad profit soars to £75m

Full details on page 4

PLUS TWO REVEALED

We lift the lid off the new Spectrum

ST ARENA ▶

Check out Software Hotlines for details

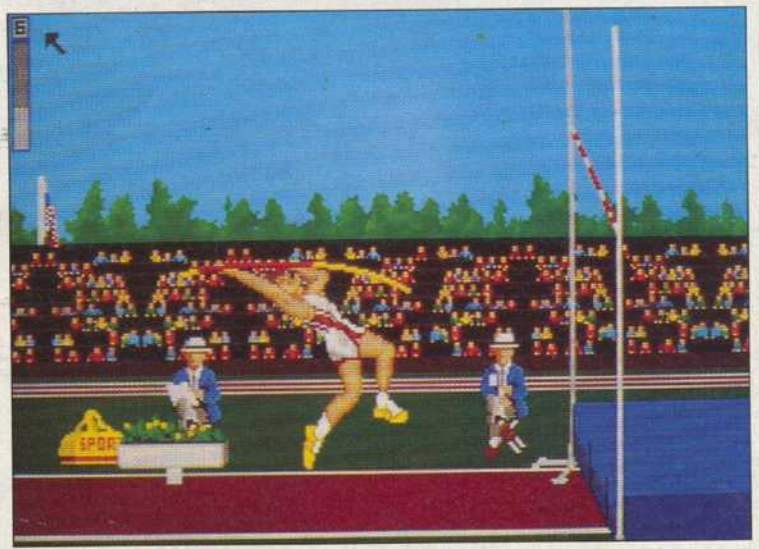

NEWS DESK

Amstrad show report

Cool welcome for Commodore 64C

Amstrad ban on copying programs



HARDWARE REVIEW: THE NEW TATUNG EINSTEIN 256

See page 18

The £2,000 Movie Quiz: entry form inside

"GAMES AT THE SPEED OF LIGHT.."

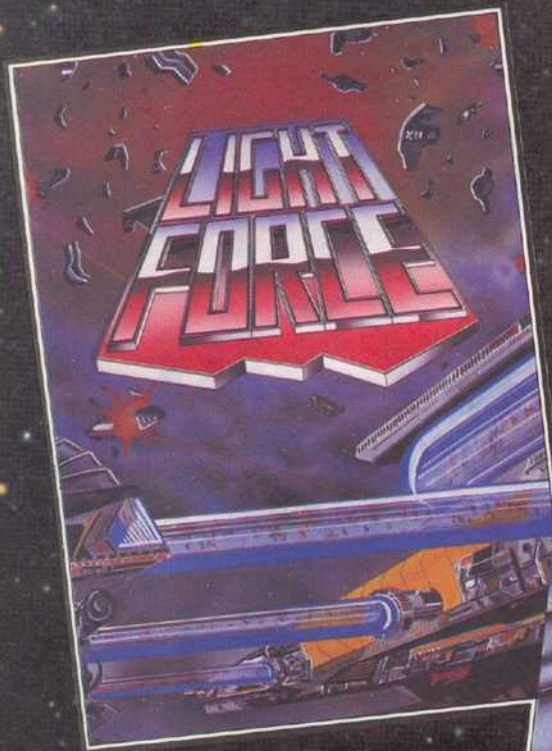

LIGHTFORCE is for **VENGEANCE**.....
LIGHTFORCE is the Punishment Arm of Galactic Fighter Command.

When a Terran-settled system at the edge of the galaxy is seized by an alien force, revenge comes in the form of a lone **LIGHTFORCE** fighter.

LIGHTFORCE confronts alien in a dazzling battle above the strange landscapes of the Ice-Planet, the Jungle Planet, Alien factories and the impassable Asteroid Belt.

LIGHTFORCE — at the speed of Light - from **FTL**.

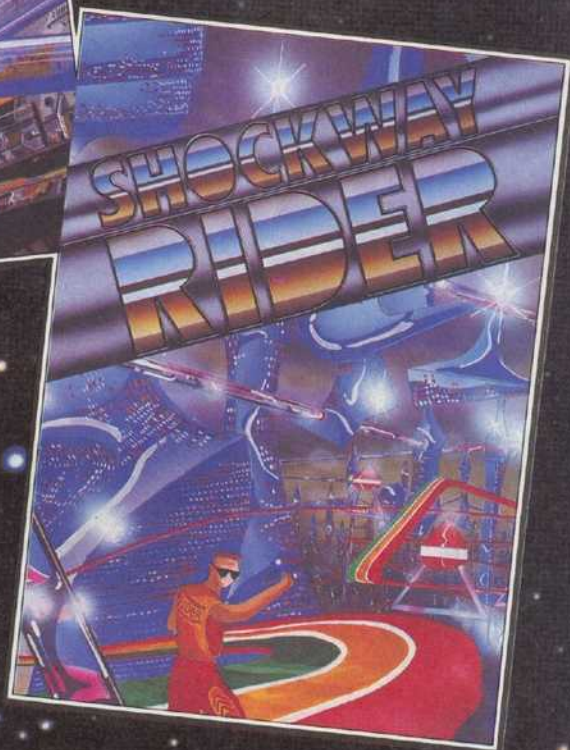

SHOCKWAY RIDERS are the pick of the street gangs - **ATHLETIC, AGGRESSIVE & ARROGANT** - as they cruise along the triple-speed moving walkways that circle the great **MEGACITYS** of the 21st Century.

THE ULTIMATE AIM OF EVERY RIDER is to go "**FULL CIRCLE**" - to do that, he must fight off the Block Boys, the Cops and the Vigilantes - as well as negotiating the Speed Traps and Rider Ramps erected by the angry local residents!

SHOCKWAY RIDER is the most original arcade game of the year - **THE ULTIMATE FUTURE SHOCK!!**

FTL
FASTER THAN LIGHT

LIGHTFORCE AVAILABLE SEPT. '86
SHOCKWAY RIDER AVAILABLE OCT. '86

SPECTRUM £7.95
AMSTRAD & COMMODORE £8.95

FTL FASTER THAN LIGHT, CARTER FOLLIS GROUP OF COMPANIES,
SEDGLEY ROAD EAST, TIPTON, WEST MIDLANDS DY4 7UJ. Tel: 021-520 2981 (4 lines)

GAMES ▶

12 Adventure Corner

Tony Bridge looks at the Royal spoof, *HRH* from Eighth Day Software.

13 Adventure Helpline**14 Reviews**

Sanxion, the first game from new



company Thalamus, goes through the *Popular* grill, as does *The Inheritance* from Infogrames, and Superior's *Stryker's Run*.

16 Arcade Action

The complete solution to *Mercenary - The Second City* hits the home straight. Includes this week's Gallup Top Twenty.

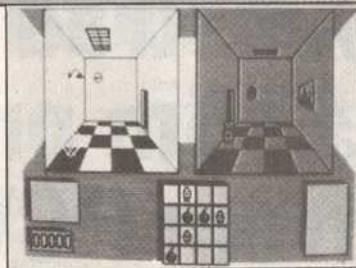
◀ **HARDWARE****18 Einstein 256**

Tatung has launched the follow-up to the original Einstein - The Einstein 256, complete with built-in 3 inch disc drive and colour monitor, all for £399. Duncan Evans has the details.

21 Spectrum Plus 2

Andy Pennell brings you the definitive low-down on the Spectrum Plus 2, internal changes and all.

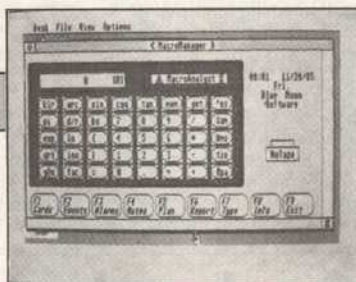

SOFTWARE ▶

22 Macro Manager

A desk top utility for your Atari ST, comprising diary, calculator, calendar, card file and alarm system.

Many similar utilities leave one asking if they're really any more useful than real diaries or calculators, but Duncan Evans found Macro Manager more sensible than most.

◀ **PROGRAMMING****23 BBC/Electron**

Continuing Mark Slater's Soccer program. They'll be typing this one in at Old Trafford.

24 Spectrum

Get the best from your Ram disc.

25 Commodore 64

The final part of Minz.

26 QL

Utility procedures for your QL.

29 Bytes and Pieces**27 Amstrad 6128**

Want a Ram disc for your 6128? Well, here it is, courtesy of Brian Cadge.

43 Peek & Poke

REGULARS ▶

4 News Desk**10 Letters****34 Communications****35 Competition**

If you want a Spectrum Plus 2, a Star Micronix printer, or a Mastertronic Magnum joystick, look no further.

37 Soundcheck**44 New Releases****46 Ziggurat, Hackers**

Editor Christina Erskine News editor John Lettice Features editor John Cook Technical editor Duncan Evans Production editor Michelle Beauchamp Supplements editor Christopher Jenkins Supplements designer Barbara Hajek Advertisement and Promotions manager Simon Langston Assistant advertisement manager David Osen Advertisement executive Jon Beales Classified executive Rodney Woodley Editorial secretary Annmarie O'Dwyer Administration Geraldine Smyth Managing editor Peter Worlock Publishing director Jenny Ireland. Published by Sunshine Publications Ltd, 12-13 Little Newport Street, London WC2H 7PP. Tel 01-437 4343 Telex 296275 Fax 01-439 0681 Typeset by Magazine Typesetters, 6 Parnell Court, East Portway, Andover, Hampshire. Printed by McCorquodale Magazines, Andover, Hampshire. Distributed by S M Distribution, London SW9. Tel 01-274 8611, Telex 261643. © Sunshine Publications Ltd 1986. ISSN 0265-0509

Popular Computing Weekly. Tel: 01-437 4343.

How to submit articles Articles which are submitted for publication should not be more than 2000 words long. The articles, and any accompanying programs, should be original. It is breaking the law of copyright to copy programs out of other magazines and submit them here - so please do not be tempted. We cannot guarantee to return your programs - so please do not send your only copy. **Accuracy** Popular Computing Weekly cannot accept any responsibility for any errors in programs we publish, although we will always try our best to make sure programs work.

Amstrad nets £75m profit from PCW

AMSTRAD turned in another spectacular set of figures last week, showing profits up 273 per cent to £75 million for the year ending June 1986. Sales increased a mere 123 per cent to £304 million, indicating that Alan Sugar's ability to make lots of money is, if anything, improving.

The sales figures are accounted for by some 350,000 PCWs and 650,000 464s and 6128, 57 per cent of these being overseas. France turned in growth of 173 per cent, and the company's market penetration in the rest of Europe also increased substantially. US

sales were a relatively feeble £17 million, representing tens rather than hundreds of thousands of machines.

The Amstrad PCW went on sale in the States in early summer of this year, but has failed to generate any enthusiasm, like its predecessor 6128, which failed to "revitalise the home/office segment of the lagging personal computer market in the US" in 1985.

The US's deplorable reluctance to return to the CP/M standard and take up using 3 inch discs has probably influenced Amstrad's decision to launch the new PC1512 at



"It says I've just made £75 million."

the Comdex show in November, although it's not due for release there until the spring and stock shortages may push this date back further.

Sugar claims to have sold 100,000 PC1512s already, although they're not due to be shipped until later this month, and was last week suggesting that production wouldn't keep pace with demand until

June 1987. Dixons' waiting list only seems to be backed up into January, but it's still difficult to see how Amstrad can launch in the States.

The company's products so far have, however, been launched too late to catch growing markets in the US, and Amstrad must be conscious that this could also happen to the PC.

Cool welcome for 64c in the high street

COMMODORE'S new 64c is now in the shops, but it has yet to make it into the major multiples and appears to be meeting stiff competition from the old style 64. Commodore maintains that it will be available through the major high street chains, but won't say which ones, or whether

negotiations have been completed.

Dixons, Boots and W H Smith currently are not stocking the machines. Dixons are to stock the machine shortly, while Boots and Smith are for the present continuing to stock the old 64. Various branches contacted felt that

there would be no shortage of the older — and £40-£50 cheaper — machine in the run up to Christmas.

The 64c has made it into the independents, but is being sold alongside the older model, with London dealers Galaset, Hi Voltage and KK Stationers all quoting prices £30-£50 lower for the latter.

At the time of the 64c's launch Commodore described the machine as "a worthy successor to the 64," but the machine's high price tag plus the continued availability of the old 64 seem to be damaging its chances of taking over.

It does appear that Commodore is currently in negotiation with the chain stores, and hopes still to get the new machines accepted. Time, however, is not on the company's side, as the stores are now on the point of finalising their Christmas plans.

Japan enters brand new trade cycle

THE failure of MSX to make an impact in this country was evidence that the Japanese weren't invincible after all. But now, if the *Japan Times* is to be believed, they're losing their grip completely.

Sanyo has produced an electric tricycle called the 'Amorton Car', solar-powered and capable of a top speed of 15mph. Sound familiar? Funnily enough it looks just like a certain other British-made trike . . .

PC 1512 hard disc price

DISTRIBUTOR Northamber's 20Mb hardcard for the Amstrad PC (see *Popular*, 25 September 1986) is to cost £618. A PC fitted with the card will cost a shade more than the PC1512 from Amstrad, but the card is available now, while hard disc versions of the PC are in short supply.



Glamorous 64 finds it tough.

Amstrad in ascendant

- show report

THE lull before the storm? The Amstrad show at London's Novotel last week was, as ever, well attended but with the PCW and its third party support already well-established and the PC yet to arrive in any great numbers there were few new products to gladden the hearts of owners and prospective owners.

That said there were signs that the PC wave is gaining momentum, with numerous software houses showing budget products for the new machines. New Star, which cut its teeth on budget CP/M software, led the pack with dBase and Lotus workalikes for £99 and was also showing *PC Outline*. Brown Bag Software's excellent outline processor, which it is selling in this country.

PC veterans Caxton Software and Software City were

in hot pursuit, Caxton with a reduced price range retailer for the 1512 and Software City with *Ability* (see separate story). Cambrian Software has ported its business and accounting software range across to the PC, while Robtek was extolling the virtues of *Pyramid*, out for both PC and PCW at £99.95 and described as an easy to use integrated financial system.

Tasman Software probably broke two records at the show.

At £24.95 *Tasword PC* is one of the cheapest word processors available for the 1512, and it's almost certainly the first commercial program for the PC to have been first sold on the ZX81.

First prize for covering all the exits went to Timatic. The company's previous efforts include a 5 $\frac{1}{4}$ inch disc drive for the PCW, so there's a certain logic in its latest production - a 3 inch disc drive for the

PC1512. It only needs someone to tell the company that IBM's started selling 3 $\frac{1}{2}$ inch disc drives for its PC to make matters really confused.

The PC wasn't so well provided for on the comms side, although both Modem House and MML Systems were showing products. Modem House's is something of a rave from the grave, as the company has secured stocks of the old 1200/75 Prism 2000 and has revamped the comms software. It is however reliable and cheap, and works with the PC1512.

MML's production is *Straight Talk*, a communications package developed for the 1512. It includes a library of services and modems, plus a text processor for the preparation of ASCII files.

Back on the PCW Pace, producer of the official Amstrad modem for the PCW, was showing 5 $\frac{1}{4}$ inch drives for the machine and promis-

ing *Commstar PCW* shortly.

Despite the Amstrad takeover of the Sinclair name there was little sign of the new Spectrum Plus. HiSoft had one on display, while Kempston had produced a £6.95 interface for the machine's joystick interface (1) making the machine Kempston compatible.

Copy software and hardware (see page six) was in short supply following Amstrad's ban, but Romantic Robot appeared to have got round the problem with its Multiface 2. The device had been reconfigured for the show so that software copied with it is serialised. Copies can therefore only be used if the Multiface that produced them is connected to the machine. A harassed Roboman explained that it had been difficult to do this in time for the show, but that it appeared to satisfy the authorities.

Software Hotlines

Electric Dreams can hardly be accused of flooding the market with product since its establishment a year ago.

That, however, is set to change this Christmas, when the Southampton-based company will be hurling ten new titles, mostly over three formats each, at the unsuspecting consumer.

From a glimpse of the new range, we can say that all the

releases are well worth a look, with attention paid to graphic detail and game play. A number are based on heavyweight licensing deals - these are the sort of contracts you can get when you're backed by mighty **Activision**.

First off the duplicating machines should be Commodore and Amstrad versions of a 3D maze/find the right objects/do the right things with them game. Your ultimate task is, as a synthetic human being, to rescue a baby from the inner complexes of the mechalabs.

Then there's the much-talked about *Aliens 2*, from the hit film sequel. *Aliens 2* the film is a truly stomach-knotting tale of suspense and tension, and **Soft Machine**, the programming team, is aiming for the same effect here.

You get to control Ripley and the Marines through the control complex infested with aliens. Out November on Spectrum, Amstrad and Commodore.

One of the most interesting of **ED's** forthcoming is *Explorer*, programmed by the **RamJam Corporation**, which has come up with some pretty innovative stuff (remember *Valkyrie 17* and *Think!*). Here you've landed on a strange planet and must collect pieces of your spaceship to put it back together and escape. Doesn't sound too innovative so far, huh? Well, the graphics showing the planet landscape as you move through it are gorgeous.

And let's not forget *Dandy*, licensed from the original arcade game, not *Gauntlet* the coin-op game developed

from *Dandy*, which is US Gold's (we think that's all the right way round).

Dandy the computer game (are you still with us?) is also by **RamJam**, very fast, very colourful, detailed graphics, hordes of nasties.

Also in the pipeline are *Big Trouble In Little China* (again from the film), *Chameleon* (an out and out shoot 'em up linked to the four elements: earth, air, fire and water - you can shoot the air icon at the fire icon to blow it out, etc), *Star Raiders II* (from the coin-op), *Circus Of Death* (adventure/strategy/arcade) and *Hi-jack* (converted to C64 and CPCs from the Spectrum) and *Tempest* (more coin-operating).

Meanwhile, over on the ST **Psygnosis** is releasing *Deep Space*, an *Elite*-style space shoot-'em-up sporting highly impressive graphics. Your mission is to destroy the aliens and recover objects for the Corporation. The console includes pull-down control panels for your on-board computer and a baffling range of scanners. Well worth a look. **Christina Erskine**

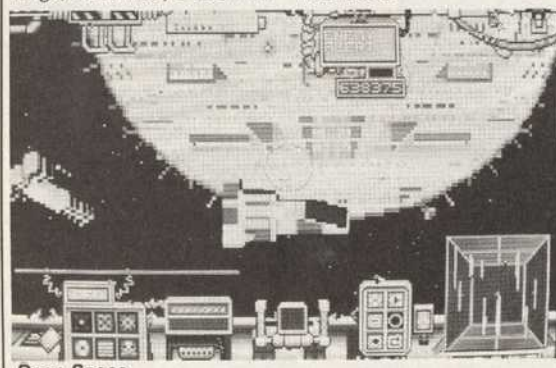

Deep Space

Amstrad ban on copiers at show

COPYING utilities were banned from last weekend's Amstrad Computer Show at the instigation of Amstrad itself. Organiser Database Exhibitions wrote to all show exhibitors at the end of September saying that "products designed to breach the copyright laws by producing pirate copies of a wide variety of software titles should not be available at our exhibition."

Database defines this sort of product as those allowing a program to be frozen for copying purposes, disc to disc copiers and tape to tape copiers. Products which can do one or more of these, but not as their prime function, "are usually quite acceptable."

It seems the relatively drastic action was taken in response to a threat from Amstrad to pull out of the show. "We were getting a lot of

hassle and stick from people who write software under licence for us," says Mike Mordecai, software sales manager for Amstrad. "We could not be seen to be supporting companies who sell products that hack open other people's programs."

Database has the right to refer to the show as the Official Amstrad Computer User Show, and the message seems to have been that if the ban wasn't initiated it would become decidedly unofficial, with the presence of Amstrad itself in doubt.

Mordecai doesn't accept that there is any legitimate use for copying devices and programs. "Personally I feel these sort of devices shouldn't be allowed on the market," he says, and points out that only a very small percentage of sales of, say,

the 6128 represent users upgrading from the 464.

One of the companies affected has, however, reacted strongly to the ban. Gerry Bassingthwaite of Mirage Microcomputers says he talked to Database about the matter after the previous Amstrad show in June, and was told there would be no difficulty. He denies that his product is a tool for piracy, pointing out that it needs to be present when the copied program is loaded back, and, therefore, acts as a sort of dongle, and says he is currently investigating the possibility of suing Database.

"They decided in June, but only told us about it at the end of September. No-one from Database will tell people why we're not there, and what we want to try and tell people is we're not out of business."

Sidecar to launch at £600 in UK

COMMODORE is as predicted to launch Sidecar, its PC emulator for the Amiga, in the UK in the next few weeks. The device, which allows the Amiga to run IBM software, is to cost around £600 on its own but is liable to work out cheaper if bought bundled with an Amiga.

The company, however, strongly denies suggestions that Sidecar's appearance here is a consequence of its failure to meet US electrical standards. Commodore insists that the device has in fact passed the US approval procedure, and is keen to scotch rumours to the contrary.

3D drawing on the CPCs

ARNOR is to release *Model Universe*, a 3D drawing system for the Amstrad CPC series, at the beginning of November. The program allows rotation on any axis, full perspective display and features a zoom facility. Drawings can be output to printer, disc or tape. It comes with a free copy of the *Gatecrasher* strategy game bundled and costs £15.95 for tape and £19.95 for disc.

The company is also to release its Protext word processing, mail merge, spelling checker and disc utilities package for the PCW and 6128 in November at £79.95.

Details from Arnor, 118 Whitehorse Road, Croydon CR0 2JF. Tel: 01-684 8009.

Rainbird boss leaves company and surname

RAINBIRD Software is to lose its founder and namesake, Tony Rainbird, who has resigned from Telecomsoft.

He is to leave next month, and Paula Byrne, currently Rainbird's marketing manager, will take over his position as head of Rainbird.

"I don't know what I'll be doing next," said Tony. "But I'll be staying in the micro software industry."

"Working within Telecomsoft has its constraints, and I'm keen to get out and see if I can progress - I won't know until I try."

"I've set up Rainbird much the way I wanted to, and there are no problems with the team. Everyone is very pleased that Paula has been selected for the post."

Rainbird - the software house - will keep its name, which is obviously a Telecomsoft trademark, as well as belonging to its erstwhile boss.

Infocom to shed light on adventures

FOLLOWING the demise of the Adventurers' Club, better news for adventure fans with the announcement that Dave Lebling (MD at Infocom) has become Chairman of that long-standing fanzine, *Guiding Light*. The 'zine has just gone bi-monthly and is available at £1 per issue from Roger Garret at 52 Micawber Way, Chelmsford, Essex, CM1 4UG.

Footnotes

AN eagle-eyed *Popular* reader spotted the first Spectrum Plus shipment (six) arriving in an Essex computer store last week. The date was September 30, so the machine was as promised in the stores by the end of September. People who shop in the multiples will, however, have to wait till the end of this week.

Meanwhile, Alan Sugar is suggesting that he could put up the price of the Amstrad

PC in January to try to cut down on demand, but either the man's marketing expertise has left him or the suggestion should be taken with a pinch of salt.

Putting the price up now might shorten the waiting list, but won't a promised rise in three months stimulate demand further as people buy now while stocks last? By January, of course, Sugar will have 100,000 to shift each month to keep pace with production.



Running soon - Protext

Proops goes for discounts on software

LONDON discount warehouse Proops Distributors has taken delivery of around 1,000 software titles for a range of machines, including the 64, BBC and Spectrum.

Prices and quality are distinctly variable, but examples include a 64 word processor of Canadian origin reduced to £30 from a list price of £86, and a Spectrum compilation pack down from £14.99 to £5.

Details from Proops Distributors, Heybridge Estate, Castle Road, London NW1. Tel: 01-267 6911.



THALAMUS



AXION



By
STAVROS
FASOULAS

CBM 64/128

CASSETTE £9.95 DISK £14.95

THALAMUS LIMITED,
Front Office,
1st Floor Advance Works,
44 Wallace Road, London N1 1PQ

Distributed by US GOLD LIMITED, Unit 2/3 Holford Way, Holford, Birmingham B6 7AX Tel: 021-356 3388



Sport portable PC

THE PC Sport is a semi-portable PC compatible designed to operate with either monitor or TV. In the latter mode it uses an RF modulator to plug into a TV, and can, therefore, be used at home or in hotel rooms. An LCD screen is also available for it as an option.

The machine weighs 9lbs, runs an 8088 chip at 4.77MHz, and includes RGB,

composite video, serial, parallel and joystick ports. It has a base memory of 256K expandable to 640K, and has a single 5 $\frac{1}{4}$ inch disc drive built in. Price for the base machine is £444.

Details from Applied Microsystems Technology, 32/34 Cricklewood Broadway, London NW2 3ET. Tel: 01-452 4256.

Integrated pack for £70

ABILITY, Xanaro Technologies' highly regarded integrated package for the IBM PC, is now being sold in this country by Software City at £69.95. The package includes word processor, database, spreadsheet, business graphics, presentation graphics and communications software, all with a common command

structure and the ability to move files from module to module.

Details from Software City, 382 Kings Road, London SW3 5UZ. Tel: 01-352 9220/6181.

Micro training by mail order

EDUCATIONAL software supplier Microwise UK is now offering correspondence

courses in computing. The courses are aimed at both children and adults, and are currently available for Amstrad CPC, Spectrum, Atari 800XL, BBC B and Commodore 64 computers. Subjects available include introductory and advanced programming, assembly language, graphics and applications.

Details from Microwise UK, Freepost 468, Colchester CO3 4BR. Tel: 0206 575718.

Both versions are also supplied with file transfer routines that allow MSDOS discs to be read by the Amstrad.

Details from Pace Micro Technology, Juniper View, Allerton Road, Bradford BD15 7AG. Tel: 0274 488211.

Low cost 64 disc drive

COMMODORE users who're having trouble getting hold of the 1541c disc drive now have another option - the Chinon Enhancer 2000. This drive is faster and more reliable than the 1541c, and at a total price of £148.75 it's also cheaper.

Details from Firstline Software, 206 Great North Road, Eaton Socon, St Neots, Cambs PE19 3EF (0480 213969).

Pace set for PCW

PACE is launching a range of 5 $\frac{1}{4}$ inch disc drives for the Amstrad CPC and PCW machines. Both versions give a CP/M formatted capacity of 800K, and the CPC have the advantage of being able to read and write discs under both CP/M and Amstrad.



Diary Dates

OCTOBER

25 October

20th ZX Microfair

Central Hall, Westminster, London SW1

Details: Sinclair machines, hardware and software support.

Price: £1.50 adult, £1 children for advance sales, £2 and £1 on the door.

Organiser: Mike Johnston, 01-801 9172.

27 October

Computer Club 86

Blue Coat Comprehensive School, Birmingham Road, Walsall
Details: Mainly Amstrad but includes a Sinclair corner

Price: 25p

Organiser: West Midlands Amstrad Users Group, 021-420 1915

30-31 October

Hampshire Computer Fair

Guildhall, Southampton

Details: Business computers.

Price: Free entry by business registration.

Organiser: Testwood Exhibitions, 0703 31557.

NOVEMBER

7-9 November

Electron and BBC Micro User Show

New Horticultural Hall, Graycoot

Street, London SW1

Details: Hardware, software and peripherals for the Electron, BBC micro and Master series.

Prices: £3 adults, £2 children, £1 discount for advance booking.

Organiser: Database Exhibitions, 061-456 8835.

8 November

UKEUG National Einstein Show

National Motor Cycle Museum, Birmingham

Details: Einstein software and hardware.

Price: Free.

Organiser: UKEUG, 07982 2399.

29 November

Wight Computing Fair

Ryde Town Hall, Ryde, IOW

Details: Local show covering wide range of subjects

Price: N/A.

Organiser: Wight Computing Users Group, 10 John Street, Ryde, Isle of Wight PO33 2PY.

Prices, dates and venues of shows can vary, and you are therefore strongly advised to check with the show organiser before attending. *Popular Computing Weekly* cannot accept responsibility for any alterations to show arrangements made by the organiser.

5 FUN FILLED GAMES



NOW GAMES



Virgin Games presents the third fantastic compilation in the **NOW GAMES** series... 5 best selling full price games on one tape for the price of one full price new one!

NOW GAMES 3 is a wide choice of high quality games the whole family can enjoy. Available for **COMMODORE 64**, **SPECTRUM 48** and **AMSTRAD CPC**.

NICK FALDO PLAYS THE OPEN

Mind Games

This beautifully presented simulation features 900 scrolling screens of authentic action over the 18 holes of the Royal St George's course in Sandwich.

SORCERY

Virgin Games

This beautifully designed arcade adventure features great graphics and gameplay as it transports you to a land where evil must be defeated and the power of good restored.

CODE NAME MAT II

Domark

You are the Captain of Centurion II in this exciting shoot-em-up. Your ship has a range of weapons, shields and a tracking system, but you must decide the best strategy to eliminate the attacking Myon craft.

EVERYONE'S A WALLY

Mikro-Gen

This is a multi-screened arcade adventure featuring excellent cartoon graphics and lots of humour. Use your ingenuity to get the gang working and uncover the combination to the wages safe.

VIEW TO A KILL

Domark

Spectacular 3 part multi-screen arcade adventure based on the James Bond film. There's a car chase around the Eiffel Tower, a rescue from a flaming City Hall and some code-breaking at Silicon Valley.

Look out for **NOW GAMES** and **NOW GAMES 2**, still the best value around. For **COMMODORE** and **SPECTRUM**.

NOW GAMES 3 is available from all good software stores or, if you have difficulty, directly from Virgin Games.

Please make your cheque or postal order payable to Virgin Games Ltd. Please do not post cash.

NOW GAMES 3 is £9.95, please tick the version you require. COMMODORE SPECTRUM AMSTRAD.

NOW GAMES 2 is £8.95 (features: Air Wolf, Chuckie Egg, Tir Na Nog, Cauldron, World Cup II).

COMMODORE SPECTRUM.

NOW GAMES is £8.95 (features: Lords of Midnight, Brian Bloodaxe, Strangeloop, Pyjamarama, Arabian

Nights, Falcon Patrol II) COMMODORE SPECTRUM.

£9.95

Name

Address

Virgin Games Ltd, 2/4 Vernon Yard, Portobello Road, London W11 2DX



Ahead in the 80s

A couple of years ago, my wife and I decided we really ought to drag ourselves into the 80s, and we eventually ended up with a Commodore 64, disc drive and SG10C printer. We soon found that pure computing or computer games bored us, and now we both use the equipment for word-processing (*Wordcraft 40*), and I take my chief pleasure otherwise in graphics, including text.

Most of my programs are now getting a little old. I would very much like to try some newer programs, but all the shops and mail-order outlets seem to be preoccupied with games.

Is there a shop - preferably in the West End of London, or indeed anywhere else - that specialises in non-games. How do I find out, other than by spending a fortune on every computer mag on the market, just what is available, and where I can buy it, preferably after at least examining the manual, and better still, having a hands-on trial?

Brian R Caukwell
Milton Keynes

We can't think of any shop which actually specialises in non-games in the West End, but Pilot Software City, in Rathbone Place, London W1, does stock a wide variety of products.

You've probably tried your local software retailers, but we understand that Softly, in the Milton Keynes main

shopping centre, and Rams Computer Centre in Bletchley, are by no means solely games orientated.

Do keep an eye out for advertisements for utilities in magazines; and also nearly all software companies will sell their programs direct to customers, if you write to them asking for more details.

A label of thanks

Recently I decided to sort out my Microdrive cartridges. In doing so, I used up all my spare labels. I immediately rang Transform, which supplies Microdrive storage boxes. It referred me to its factory, which agreed to send me some labels.

The next day, I received 30 labels in the post. I would like to thank them, as the company does not sell labels normally, and for the fast service.

Simon Walker
Redditch

Trying to find a better way

In the Star Letter in the issue dated September 25, Alex Aird came up with a novel method of solving the problem I sent to Peek and Poke (*Popular*, September 4).

As yet I have been unable to try this solution as I am in the process of moving, but if my memory serves me correctly even this will not work.

This is because bytes 66 and 67 of the header of an Amsdos disc file hold a file

Take the high road to Glasgow

When are we going to see a major micro-computer show hosted in Scotland?

As most computer companies tend to operate from bases south of the border, I can't help but notice an annoying tendency on their part to refute acknowledgement of any place north of Manchester.

I realise that the population is more concentrated further south and that it may not be viable for one manufacturer alone to display its durables. An exhibition, however, combining proportional representation of all major companies would be an unmitigated success, the magnetism of which would attract and appeal to a wide range of users with varied interests.

I am convinced that an exhibition of this type would generate considerable interest and enthusiasm among the Scottish user base.

It's not as though Scotland has no suitable venues. The city of Glasgow has poured a

staggering £36 million into its showpiece, the Scottish Exhibition & Conference Centre (SECC), just for such purposes.

The potential of the SECC has already been realised by several areas of industry, not least the business computer sectors, whose Scottish Computer Show attracted an estimated 10,000 visitors over a three day period.

Part of the blame for the recent slump in the micro-computer industry must, I feel, be levelled at the companies themselves. If they fail to exhibit their products effectively, how can they expect to sell them?

I hope this letter will be instrumental in gaining some positive response not only from the industry in general, but also from exhibition organisers, and from the end users themselves, without whose support there would be no market.

Stuart Low
Alloa

checksum. If Alex's method is used the checksum will be incorrect for the file contents and an error will occur when the file is read. My solution to the problem is to use the information stored in the directory entry for the file, coincidentally explained in Peek and Poke, Sept 25, to determine where on the disc the program is stored.

Then, using the disc Rom

routine to read sectors from the disc, move the file contents in Ram. Finally, save the file as normal, using:

```
SAVE "TEST.BIN", b, start addr, length
```

Note that the default load address may now be incorrect for the file contents. As Alex said if anyone knows a better way I would like to know.

Shoel
Stafford

Puzzle

Puzzle No. 228

I recently acquired some coloured plastic numerals of the sort that you might use to display your street number on your front door. In the numerals that I had, each of the different digits was made in a different coloured plastic, though every similar digit was in the same colour.

By taking a number of digits in red, green, blue, and yellow plastic I was able to form the following multiplication:

$$RGGB \times BYRG = Y \dots \dots$$

I have indicated the colour of each numeral by using the initial letter of the colour. The product so formed consisted of eight numerals, all of them of the colours already mentioned. I do remember that the first number was made of yellow plastic.

Can you find out the missing colours and say which digits they represented?

Solution to Puzzle No. 223

A maximum of ten primes can be found provided that the cards bear the numbers 27, 41 and 77. From these the following primes can be obtained: 2741, 2777, 4177, 7741, 7727, 4127, 274177, 277741, 417727 and 774127.

```
5 DLS
10 FOR A=11 TO 95 STEP 2
20 FOR B=A+2 TO *7 STEP 2
30 FOR C=B+2 TO 99 STEP 2
35 SM=0
40 T=A*B*C:GOSUB 1000
50 IF FL=1 THEN SM=SM+1
60 T=B*A*C:GOSUB 1000
70 IF FL=1 THEN SM=SM+1
80 T=A*B+C:GOSUB 1000
90 IF FL=1 THEN SM=SM+1
100 T=A*B+C:GOSUB 1000
110 IF FL=1 THEN SM=SM+1
120 T=B*A*C:GOSUB 1000
130 IF FL=1 THEN SM=SM+1
140 T=C*B+A:GOSUB 1000
150 IF FL=1 THEN SM=SM+1
```

```
160 T=A*10000+B*100+C:GOSUB 1000
170 IF FL=1 THEN SM=SM+1
180 T=A*10000+C*100+B:GOSUB 1000
190 IF FL=1 THEN SM=SM+1
200 T=B*10000+A*100+C:GOSUB 1000
210 IF FL=1 THEN SM=SM+1
220 T=B*10000+C*100+A:GOSUB 1000
230 IF FL=1 THEN SM=SM+1
240 T=C*10000+A*100+B:GOSUB 1000
250 IF FL=1 THEN SM=SM+1
260 T=C*10000+B*100+A:GOSUB 1000
270 IF FL=1 THEN SM=SM+1
280 IF SM<3 THEN PRINT:A:B:C:(" ");SM:(" ");"/";
290 NEXT:GOTO NEXT
310 END
1000 FL=0
1010 FOR F=3 TO SQR(T)+1 STEP 2
1020 IF T/F=INT(T/F) THEN FL=1:GOTO
1030 NEXT F
1040 RETURN
```

Winner of Puzzle No. 223

The winner this week is John R Paton of Paisley, Liverpool who will be receiving £10.

Rules

The closing date for Puzzle 228 is October 27

Trying to find a printer

I read with interest Brian Haines' letter (*Popular*, September 18), concerning where to buy a disc drive and a small printer for the Oric Atmos. He may like to know that WE Software, the UK agents for Eureka Informatique and Oric Products International has on sale the Oric/Eureka 3 inch disc drive with the powerful Sedoric DOS for £239.65. This is a special offer which ends on October 16.

As for a small printer, WE offers the Brother HR5 Centronics printer for £126.50. He may also like to know that WE has word processors on sale - *The Author* at £14.50, and *Oricstar* on 3 inch disc for £12.95.

To any other Oric owners who read *Popular Computing Weekly*, I would like to mention my bi-monthly 16 page newsletter, which I run, called *Your Oric*.

Anyone interested in the newsletter can contact me, with SAEs.

K Thompson
41 Morden Gardens
Mitcham
Surrey
CR4 4DH

Trying to find a colleague

As a serious BBC Micro owner I've mastered both Basic and machine code. I can boast to knowing the machine virtually inside out. But despite this I've never actually completed any worthwhile programming project, the sort of thing that gets published in your magazine or by a software house.

I find one of the main problems is getting enough motivation together to keep at it for the three months or so necessary to produce a number one hit.

Anyway, to come to the point, this has given me an idea for a new user group for the Beeb and I'd be most grateful if you'd publish my address so that potential members can contact me.

I hope to get together a group of programmers to combine expertise and perhaps work on joint programming projects, sharing the

work-load involved. If your readers are at all interested then I ask them to write to me for more details.

Paul Phillips
13 Mountain Road
Conwy
Gwynedd

Quilled again

As another *Quill* user, I echo the sentiments of Fergus McNeill in *Popular*, September 17. The limitations of GAC means that an adventure written on the utility is instantly recognisable (even more so due to the amazing lack of an option to use an alternative set), whilst *Quilled* adventures still hold a certain amount of originality and freshness.

With the advent of further modules to enhance *The Quill* system, I for one know which method of adventure writing I'll be using. But let us remember that it is up to the imagination of the author to create a good adventure, no matter how sophisticated the utility!

Craig Davies
Blackpool

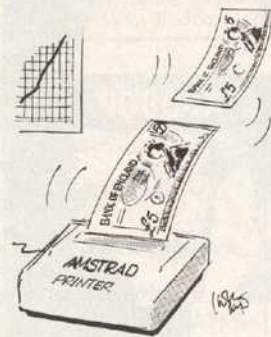

NQNQLQ

Many thanks for the letter from Andrew Bowman of the improbable address, Drymen in Glasgow. He wrote

```
10>REN ***PRINTER CONTROLS***
20 FORMAT "b";%600; OPEN #3;"b
"; OPEN #4;"1"
100 FOR N=1 TO 3
110 PRINT #3;CHR$ 27;CHR$ 51;CHR
R$ 2;
120 PRINT #3;CHR$ 27;CHR$ 101;C
HR$ 1;CHR$ 1;
130 GO SUB 1000+N*10
140 GO SUB 1000+N*10
150 PRINT #3;CHR$ 27;CHR$ 50;
160 PRINT #4; PRINT #4
170 NEXT N
199 CLOSE #3; CLOSE #4; STOP
1010 PRINT #4;"PARAGRAPH NO. ONE
NOW PRINTING."
1015 RETURN
1020 PRINT #4;"PARAGRAPH NO. TWO
NOW PRINTING."
1025 RETURN
1030 PRINT #4;"PARAGRAPH NO. THR
EE NOW PRINTING."
1035 RETURN
```

in your September 18 issue on manipulating printer line spacing from software to produce NQNQLQ (Not Quite NLQ) as a useful intermediate print.

My machinery is the Brother M1009 printer working with Spectrum or QL. The M1009 control codes are Epson type. I think that the attached routine I think proves Andrew's contention that his recipe can work with a variety of printer-computer mixes. Line 110 sets the shift interval to 2/216". Line 120 calls the vertical tab mode in which the line feed is now set at 2 units. Lines 130-140 give the two passes over the current item of text at the different levels to give a transposed 2nd strike. Line 150 is the code to re-set line space to 1" to enable. Line 160 to provide the space between items or paras.

Changing the last value in line 110 from *Chr\$ 2* to *Chr\$ 7* will reduce the shift to one unit giving a double strike character with no more sign of the join than in Ernie Wise's hair-piece.

The M1009 has its own command (*Chr\$ 27;Chr\$ 71;*) for double strike printing which will usually suffice but the DIY approach offers flexibility. For instance, there is a useful enlarged-combined-with-condensed print mode which gives eight characters to the inch with a nice increase of emphasis.

The M1009 does not allow double strike with this combination. This adaption of Andrew's recipe enables the added double strike and gives a very definite and not too spread out print very suitable for notice boards or emphatic sub-heading variety.

To produce this particular face, insert the following line:-

```
125 PRINT#3, CHR$ 15; CHR$ 27;
CHR$ 87; CHR$ 1;
```

I would agree that following Andrew's idea should prove useful in filling gaps in the print controls provided ready made by the makers.

G C Watson
Croydon

Racing along

I am moved by your review of Digital Integration's *TT Racer* (*Popular*, September

18) to do something which I normally avoid, namely to write and complain.

Well, to be fair, I don't really mean to complain but rather to point out an error or at least a lack of care in John Cook's review.

He suggests that the program is far from realistic, because he was able to go round the track flat out and not crash. If Mr Cook had changed the difficulty setting of the game from 'club' to, say, 'grand prix', he would have been able to report that the slightest contact with the kerb or lack of care in changing down before a corner results in the rider's premature demise.

I cannot say how realistic the game really is - although I ride a motorcycle I have never taken a 500cc Suzuki around a race track. The game does of course suffer from the lack of control inherent with a joystick, but I find it very playable and well-detailed.

Try parking close to a corner on one of the more twisty tracks and watching the other riders come to grief, or wait just before the fourth from last bend at Jarama and see the others passing on the adjacent start straight. The computer controlled riders are realistic, stopping at the pits and crashing at the bad bends.

The big advantage over *Full Throttle* (the earlier Spectrum race game) is that the opposing bikes will always (well, nearly always) avoid you. I found in *Full Throttle* that while I could manage the corners, it was almost impossible with a joystick to make the fine adjustments needed when overtaking other riders.

A few tips for *TT Racers*: use the road instruments because judging your speed is almost impossible. Practice getting the right speed into corners. If you are too fast or too slow you will weave about but with the correct speed the bike will lay over neatly and whip around the bend. Try following the others to see how they do it.

Sorry if this letter has run on a bit - there are not many computer games that I like, so I get a bit carried away (usually, in *TT Racer*, on a stretcher).

M Beal
Sussex



Budgeting for success

Tony Bridge looks at a number of recent budget and near-budget adventure releases

Let's talk budget this week.

I find the word 'budget' rather misleading nowadays when applied to adventure – most £2 and £3 games are equally as good as most of the £9 ones, though of course, there are exceptions to be made in the case of Level 9's and the more expensive *Pawn* and the Infocom catalogue (some versions of which are a mere £10 and superb bargains not to be missed).

One of the first houses to produce budget adventures was Eighth Day. Its *Quill'd* games, half a dozen or so of which were released a couple of years ago at just 99p (though I see that inflation means that they are now £2.50), were all full of humour and tough puzzles and a certain amount of atmosphere, though the packaging was understandably austere.

Since then they have been lying low, but they are now back with a vengeance and *HRH*, "the game for all the (Royal) family". Although you may at first think that this everyday story concerns a rather higher social stratum than yours, don't be misled!

The story starts as your weekly Giro cheque falls on to the mat – Great! Except that, oh dear, someone's booped and you seem to have received not your own modest few quid, but a more worthwhile quarter of a million! Well, you're an honest person (and you can't quite see how Ma'am is going to manage to feed the corgis and horses with your measly pittance), so as a loyal subject you must of course return the cheque to its rightful owner at Buck House.

The ensuing story concerns your adventures in achieving this very noble aim.

The whole point of this little romp is to poke fun out of the Royal family, and this in a completely devastating fashion. There is a lot of atmosphere in the locations, which take the player round and round the West End of London, and

the characters, both Royal and commoners, are well-drawn and almost seem to live, which is quite a feat in a *Quill'd* story.

Patch'd and *Illustrated* with rather abstract pictures, the game is well presented and the humour is pretty broad throughout, leaning heavily for inspiration on *Spitting Images* and displaying a neat way with puns.

this, you must visit a phone box three times and then convey, each time, a message to Prince Andrew at the Rocks-off night club. These messages are to do with the results of certain "tests" which are of great interest to the Prince, who shows his gratitude by bribing you with the bubbly.

Last, the price – I know that I started by talking about budget games, but I'm disappointed to see that Eighth Day have moved into the realms of £6.95 software, and *HRH* is, quite frankly, not worth it. At £3 or £4, I would have no hesitation in recommending it, but at this price, I have to say that you should invest only if you, like the authors, really want to take part in mocking the monarchy.

Eighth Day, 18 Flaxhill, Moreton, Wirral L46 7UH.

And now to more *Quill'd* stories. These two are from David Edgar of Scotland. *The Dragon of Notacare* and *Treasure* cost just £2.50 each and are well-presented with a very neatly re-designed character set – but each is let down by appalling spelling (both title pages, for instance, displaying mistakes and silly ones at that, which should surely have been picked up by more than casual play-testing).

Both titles give a fair indication of the games themselves (*Kill* the former and *Get* the latter), and really offer nothing that hasn't been seen in thousands of other

adventures, which at least have the distinction of being first. As usual, examining and searching every object and location pays dividends; there are some neat little puzzles, of course (otherwise, why would anyone bother writing an adventure?) but all in all, I can't help thinking that, with good budget software around like *Seabase Delta* and so on, scenarios and plots like these should be offered as a no-frills database at a realistic 50p or £1. David lives at 1 High Parksail, Erskine, Scotland PA8 7HY.

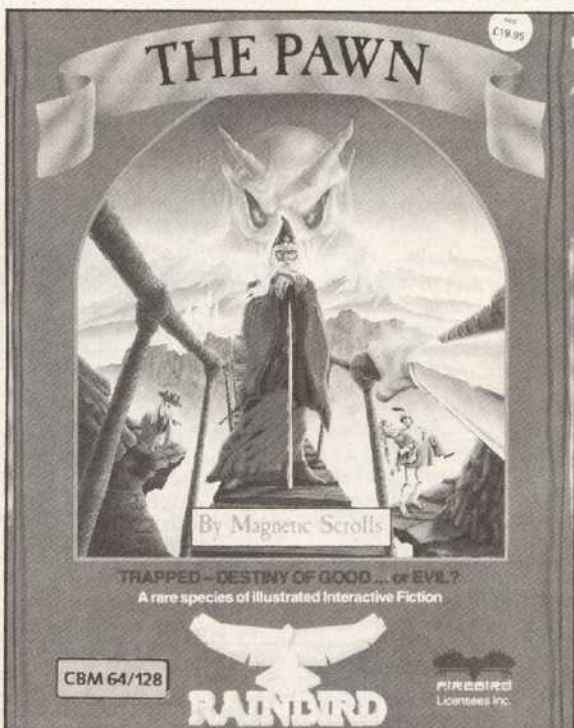

If you've seen and enjoyed that series you'll probably find that the authors' sense of humour, relying as it does on Randy Andy, Phil the Greek, Corgis and large pink plastic ears, may well coincide with your own.

However, there are problems: first, with the problems themselves, which are rather convoluted, with solutions which are not immediately obvious. For example, near the start, you must get drunk in order to get the pink elephant with which to bribe Prince William. To do

Adventure Helpline

Going bananas? If you are stuck in an Adventure with nowhere to turn do not despair - help is at hand.

Fill in the coupon, explaining your prob-

lem, send it to us, and a fellow adventurer may be able to help.

Remember - the system only works if those adventurers who have solved the puzzles get in touch. Every week is Save An Adventurer Today (SAAT) week!

Adventure on (Micro).....
 Problem
 Name
 Address.....

ZZZZ (Mastertronic) on C64. What do I do once I reach the pit? The orchestra is waiting and I don't know what to do. Michael Kukielka, 43 Clarendon Road West, Chorlton Cum Hardy, Manchester M21 2RN.

Bored of the Rings on Spectrum. Any information concerning the third part would be most welcome. Simon Amos, 22 Albert Road, Tonbridge, Kent TN4 2SR.

Red Moon on C64. How do I get past the watch dog, and how do I cross the chasm? Also I can't get out of the first location of Robin of Sherwood. Help! Stefan McGowan, 47 Hallgarth Circle, Kendal, Cumbria LA9 5NU.

Mordon's Quest on Atari 800XL. Where do I fill the aqualung and how do I open the barrier? Barbara Armitage, 46 Cinque Ports Avenue, Hythe, Kent CT21 6HP.

Heroes of Karn on Amstrad CPC 464. Any tips and maps! Kirsty Nichol, West Green, Marwick, Pirsay, Orkney KW17 2NB.

The Boggit on C64. How do you get out of the first room? (I'm new to adventures.) C Swift, 55 Valley View, Baildon, Bradford, West Yorkshire BD17 5QT.

Golden Baton on Atari 800XL. What's the magic word to get the lump of quartz. Peter Taylor, 13 Mackenzie Crescent, Burncross, Chapeltown, nr Sheffield S30 4UR.

Seabase Delta on Amstrad CPC 464. I cannot get the bowl and foil out of the refuse compartment, and I'm not sure of the use of the chute. I can't find the egg and I don't know what to do with the hen. I have completed and can offer help or solutions on Jewels of Babylon, Heroes of Karn, Message from Andromeda and Red Moon (plus limited help with Seabase Delta). Christopher Eng, 14 Amner Road, London SW11 6AA.

Planetfall on Atari. I have escaped the capsule and climbed the cliff, but I can't work the lift. Richard Gibbs, 34 Garden Way, Bootle, Merseyside L20 5LN.

The Mural on Spectrum. Any help appreciated. Alan Hughes, 22 Tyddynto, Menai Bridge, Gwynedd.

Hero of the Golden Talisman on C64. How do you use the Scroll spell. Where is the key to the grey door? What is the flag for? Paul Crutchley, 25 Underhill Road, Upper Beeding, Steyning, Sussex BN4 3JG.

The Hobbit on Spectrum. How do I get Bard to follow me and kill the dragon Smaug? Hayden Price, 96 Manor Road, Deal, Kent.

Velnor's Lair on Oric 1. How do I get past Velnor (wearing washed calrog skin)? D Gomer, 88 Danygraig Estate, Graig, Pontypridd, Mid-Glamorgan CF37 7NB.

"THE ADVENTURERS HANDBOOK"

The monthly book no self-confessed adventurer should be without.

"Stunning value" - Tony Bridge, PCW, issue 12 available now!

44 pages of adventure help and news for just £1

FOR EVEN BETTER VALUE
 TAKE ADVANTAGE OF OUR SUBSCRIPTION RATES

3 issues for £2.75
 6 issues for £5.00
 12 issues for £9.00

Issues 1 to 11 are still available and cover hints, maps and solutions to over 200 adventures (issues 1-6 for £5, issues 7, 8, 9, 10, and 11, £1 each).

ARCADE PLAYERS

If you enjoy arcade games why not take a look at our other handbooks - £1 each - back copies and subscriptions as for Adventurer.

Spectrum Arcade Handbook - issue 12
 Commodore Arcade Handbook - issue 11

Amstrad Handbook (including adventures) - issue 11
 BBC Handbook (including adventures) - issue 11
 C16/Plus 4 Handbook (including adventures) - issue 5

Send cheque or PO to:

H&D SERVICES (PCW)
1338 Ashton Old Road
Higher Openshaw
Manchester M11 1JG
Tel: 061-370 5666



The exciting
**NEW
 RELEASE**
 from

ANGLOSOFT

WHAT THE PRESS SAID

■ This is one of the most original games to emerge this year... high quality gameplay makes this fully deserve a MEGA. Great value! Buy it now! ■■ C.C.I. Sept. '86

■ The action can be fast and furious or cool and calculated, the choice is yours!... Droids is a highly playable game with plenty of mental challenge as well as arcade action. ■■ COMMODORE USER SEPT. '86

■ Droids is a nicely-produced arcade adventure with elements of Hewson's *Paradroid* and Epyx's *Impossible Mission*. The graphics are big and colourful and the programming is pleasantly fast and smooth... Good fun. ■■ POPULAR COMPUTING WEEKLY Sept. 25 '86

AVAILABLE NOW FROM YOUR LOCAL DEALER OR SEND CHEQUE/P.O. TO ANGLOSOFT, P.O. BOX 60, COVENTRY (PRICES INCLUDE P&P).

£7.95 Cassette **£9.95** Disk

A program for programmers

A couple of weeks ago the perceptive John Cook posed the question: "What, apart from six quid, is the difference between a budget game and a full-priced game?" in the Ziggurat column.

Sanxion, the first offering from new publisher Thalamus, provides the perfect answer.

And the answer is hype – or presentation, if you prefer. It probably took an hour or two to write the code, and six weeks to do the graphics.

At first glance, *Sanxion* looks a clear winner. The graphics are very pretty, the action is smooth and fast. Okay, so the sound effects aren't brilliant but you can't have everything, can you?

Well, the problem with *Sanxion* is that you can't have

anything – except very pretty graphics.

It's a program written for other programmers. "Coo," they gasp, "sprites in the border." "Gosh, look at that split screen scroll." "Wow, multi-speed scrolls on the foreground and background."

Unfortunately, it's boring. It's almost like *Scramble* – remember that? – with your ship moving from left to right, and the aliens throwing things at you from right to left.

Occasionally, just to keep you awake, they throw something from behind you as well.

As you progress, the things change shape, sometimes they change speed, often they change their flight pattern. But always it's shoot 'em if you can, dodge 'em if you can't.

Now there's nothing inher-

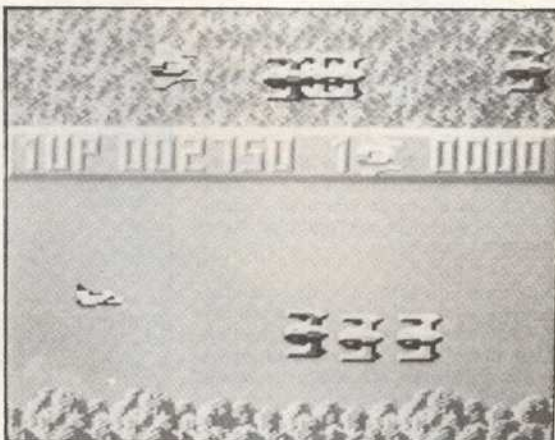

ently wrong with this. But, we're back to that question: what's the difference between a budget game and this one? Simply, at £1.99 or £2.99 this would be extremely good value. At £10 all but five pence, I wouldn't give it house room.

Recommended for desperate shoot 'em up junkies only. On second thoughts, make

that "rich, desperate shoot 'em up junkies".

Popular Appeal ♦ ♦
Peter Worlock

Program Sanxion Micro
Commodore 64 Price
£9.95 cassette, £14.95
disc **Supplier** Thalamus,
1st Floor, Advance
Works, 44 Wallace Road,
London N1.

Gambling with your inheritance

Infogrames is making quite an impression with its early batch of releases. Following the unusual and impressive *L'affaire Vera Cruz*, comes the equally unusual *The Inheritance*.

What sets *Inheritance* apart from the usual run of graphic adventures is that the graphics are crucial. In this game you actually pick them and use them.

The scenario is a touch reminiscent of *Torremolinos*;

Having made your choice, you head for the street. And this is where things get really tricky. Immediately you set foot outside your room, your neighbours will be clamouring for the return of all their stuff which you've borrowed over the past months.

You can ignore them, but you'll lose precious time. You can threaten them with the gun, knife or axe – but that might get you arrested.

You see, you only have 20

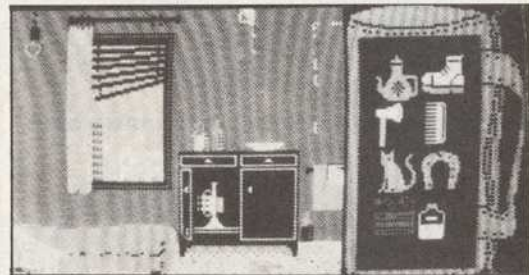

items by positioning a cursor over them and pressing fire.

Ditto for opening doors, cupboards, drawers and so on.

The graphics are well drawn and colourful, but there's little animation and the change from scene to scene can be jerky.

The major problem, however, is in playability. I found the opening apartment block sequence frustratingly difficult. Eventually I decided that being rich wasn't worth the hassle and sloped off back to my room and stayed there.

The Inheritance might be

worth investigating if you're an adventure freak, or just a games buff looking for a change from the usual.

But I'd strongly recommend you try before you buy.

Popular Appeal ♦ ♦ ♦

Peter Worlock

Program The Inheritance Micro
Amstrad CPC Price
£9.95 tape, £14.95
disc **Supplier** Infogrames,
Mitre House, Abbey Road,
Enfield, Middlesex EN1
2RQ.

"The graphics are well-drawn and colourful, but there's little animation"

you've been left a bundle of money but to claim it you have to get to the airport, make your flight to Las Vegas, and then win a fortune at the gaming tables.

You begin in your squalid little apartment and your first problem is what to take. Wallet, certainly. Gun? Might be wise in a town like Vegas. But what about that cactus plant? Or the cat?

minutes to get that plane. So, you go back to your room and get a new batch of junk and face your creditors once more.

Once you get to the airport, you're still not in the clear. There are numerous hazards to be overcome there as well.

The game is completely under joystick or cursor control. You pick up and drop

A satisfying heap of bones

To everyone's surprise, the Beeb has recently played host to half-a-dozen fine arcade games. Latest, and possibly best, is *Stryker's Run*, which combines lots of disparate ideas – *Moon Buggy*, *Who Dares Wins*, *Defender* – into a harmonious whole.

Most notable is the graphic design, which is excellent; the objects appearing on the horizontally-scrolling screen are all nicely drawn, although you will see a certain degree of flickering.

Your animated hero, Commander Stryker, has to get the secret plans through the enemy lines to headquarters, using his laser pistol, gre-

nades, and friendly soldiers. Against him is ranged the might of the White Army, consisting of soldiers, helicopters, minefields, and jets.

Stryker can jump over mines, duck under enemy shots, and run to avoid bombs from aircraft. Although getting hit loses you one of your nine lives, this isn't obvious unless you keep an eye on the 'lives remaining' counter; while enemy soldiers, when hit, collapse in a satisfying heap of bones.

Aircraft can be occupied and flown, although I always got shot down instantly.

All very good fun, added to which, shock horror innovation, there's also a Master

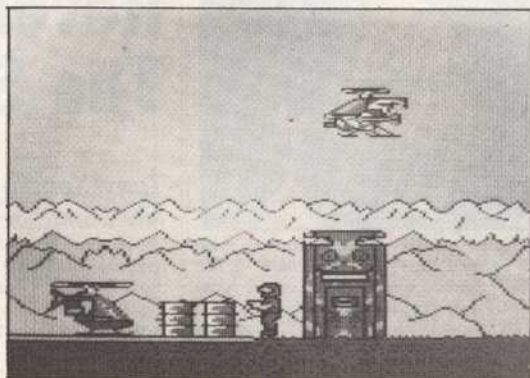

128 version of the game on the disc, including an extra 40K of graphics and music.

Another goodie from the increasingly excellent Superior Software.

Popular Appeal ♦♦♦♦
Chris Jenkins

Program Stryker's Run Micro BBC B+/128
Price £11.95 disc **Supplier** Superior Software, Regent House, Skinner Lane, Leeds LS7 1AX.

Bombs through the window

Alert! Alert! Mad dog, commie degenerate saboteurs have planted time bombs in the Gravitational Research Institute and reprogrammed robot guards to defend against intruders.

What can we do? Call in the droids, that's what. Your team of droids must roam from room to room searching for the bombs and then lob them out of a window.

It's not as easy as it sounds because many of the rooms are only connected by a portal, well out of droid reach.

The answer to that is to throw the bomb from one droid to another through the portal and head for the exit before someone gets turned into droid paste. The first of the five buildings has rooms and floors arranged on a four by four basis. To further confuse matters there is a half functioning computer in each building which has had its circuit boards scattered far and wide. Collecting and reinserting said boards repairs various functions around the building, like transporters.

The varying gravities and orientations add difficulty to the arcade element. Controlling a droid while trying to get rid of a bomb when gravity is reversed can put you in a spin.

The graphics, represented on a screen showing two rooms at a time, are in high resolution and two colours only, which makes them look extremely ordinary.

Deactivators is not really an arcade game with strategy elements, it's a graphical strategy game. A lot of thinking will be needed to complete the five buildings.

Well, I have to say that I found this game lacking in graphics, music (a sub-Hubbard tune) and price (too much by half). It may be your cup of tea but *Deactivators* failed to activate me at all.

Popular Appeal ♦♦
Duncan Evans

Drunk on Zythum

The point of *Zythum* is to find some *Zythum* and drink it. And why not, you may ask yourself?

This drink then, is a magical brew and resides in the depths of a castle which can be found by passing through four different and dangerous lands. Dangerous? Well, that's because of the appalling state of the highway in this part of mysticland.

Zythum reminded me of a graphically weak *Hunchback* with the need for accurate jumps over the bogs.

You've also got the guardians to contend with. These guardian chappies looked like oversized wasps to me but one sting, and you're dead.

Zythum is irritatingly (impossibly) difficult.

Popular Appeal ♦
Duncan Evans

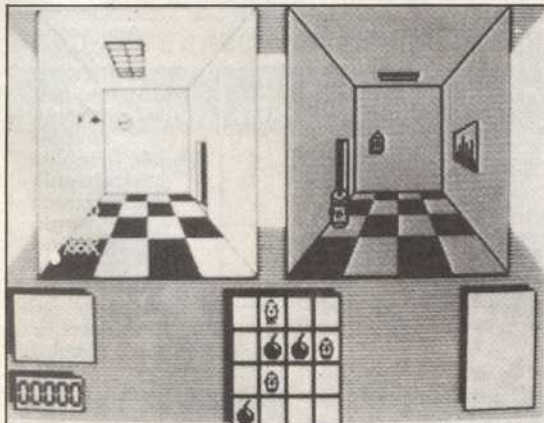

Program Deactivators Micro C64 **Price** £9.95 (cassette), £14.95 (disc) **Supplier** Ariolasoft, 68 Long Acre, Covent Garden, London WC2E 9JH.

Program Zythum Micro Spectrum **Price** £7.95 **Supplier** Mirrorsoft, Maxwell House, 74 Worship Street, London EC2A 2EN.



Reversing through The Second City

Tony Kendle completes the tips for *Mercenary - The Second City*

Continuing with Christopher Hester's tips for *Mercenary - The Second City*; the rest of the hints are more specific than those given so far.

"When you find an object of worth, such as the energy crystal, you are asked to deposit it in certain rooms for a reward. There's always a Mechanoid room and a Palyar room to choose from. Don't drop the object until you have saved the game because the reward you may get varies enormously. For example the large box fetches a hefty 202600 credits in the Mechanoid stores, but only 25 credits in the Palyar stores.

"To get the antenna you'll need to use one of the 'trigger rooms' which change the layout of the complexes. At the colony craft leave your ship in the hangar then proceed to the empty blue room to the north. This is a trigger room but the game won't show any changes until you go back to the hangar - it looks as if your ship has been stolen! Also you can't use the elevator.

"However, you will find that there are a couple of new rooms south of the second dark room replacing the deadly skull and crossbones. (If when returning to the hangar, you see your ship again, then the layout has returned to normal. More than one room acts as a reverse trigger for this layout so you may have to go back to the blue room.)

"Then you can go into the lift room, through the six sided door, and instead of finding the top level there's a single room with the antenna in it.

"If you use the transporter room north of hangar **08 (in a brown room), then you'll find yourself in the green hangar at 3.08 but you've triggered the alternative layout!

"Go through the door that normally leads to a dark room and you'll find instead an orange blank room with a very important key for you. If, however, you've got the pass, this room also lies at the end of the maze at 08.**

"Make sure you save the game position regularly as there are many traps. One room features eight doors along the wall and seven of them lead to prison!

"In the orange blank rooms move in a definite line north, east, west or south until you hit a wall. Drop an object. Then do the same for all of the walls. You can then see the size of the room from the positioning of each object, which is very useful. You can also find the door out more easily.

"To get through the maze west of hangar 13.08 enter the door then go in the following directions only - south, south, east, north, south, east, north, west. If you get stuck, drop objects to make sure you are in a different room.

"A word of warning - one of the transporter rooms will reverse all the city - east doors move to the west, etc, but north and south stay as they are! It's very confusing and makes mapping very difficult. It may be that the effect itself can be reversed but as yet I don't know how. The transporter is easily recognised because it turns orange for a second time when you enter it.

"To complete the game either make 999,999 credits then use the communication room to hire a ship (assuming it's working) you need the antenna or steal the ship from hangar 8.** and use the Novadrive to power it.

"If anyone can reveal the use of the coffin, the altered kitchen sink or any other tricks then you've beaten me.

"Now here's an unbelievable cheat for users of the *Final Cartridge* from H&P Computers. I have one of these permanently plugged in and it's really boosted

my C64. Although the following tips are amazingly useful I only used it later on in the game for making an accurate map.

"Load the game as normal then press *Restore* to freeze it. Whenever you are in a dark room and do not own the photon emitter simply press *F7* for screendump from the *Final Cartridge* freeze menu. Then *F1* and *F3* can be used to change the screen colours. In a dark room you are really looking at black lines drawn over black walls. By changing the colours you can make the lines any colour you wish so they show up. You can use this to check the doors, your position and it is extremely useful at 3.04 to check the shape of the doors. Any objects present will also be seen - try the hangar at 14.15 to see the ship.

"You are also able to see the walls in the orange blank rooms, which would be impossible even with a photon emitter.

"A warning though! Only use this cheat when you're not playing to get anywhere as the freeze menu corrupts the city above it. Look in the dark rooms then reload the game and play it.

"Also when you hit *F7* to see the screen make sure you get the top two

Charts

Top Twenty

- 1 (1) Paperboy
- 2 (-) Druid
- 3 (2) Thrust
- 4 (10) Go for Gold
- 5 (9) Trivial Pursuit
- 6 (4) Super Cycle
- 7 (8) Dragon's Lair
- 8 (3) Speed King
- 9 (12) Ninja Master
- 10 (13) Jack the Nipper
- 11 (7) Kane
- 12 (5) Ninja
- 13 (6) Dan Dare
- 14 (-) Alleykat
- 15 (11) ACE
- 16 (-) Storm
- 17 (-) Finders Keepers
- 18 (18) Glider Rider
- 19 (15) Warhawk
- 20 (14) Ghosts and Goblins

- Elite
- Firebird
- Firebird
- Americana
- Domark
- Epyx/US Gold
- Software Projects
- Mastertronic
- Firebird
- Gremlin Graphics
- Mastertronic
- Mastertronic
- Virgin
- Hewson
- Cascade
- Mastertronic
- Mastertronic
- Quicksilva
- Firebird
- Elite

All figures compiled by Gallup/Microscope

thirds as it is a split graphics/text screen. When you have finished, pressing *Return* will get you back in the game, although the colours will resort back."

Well, what can I say, Chris, except many thanks for all your hard work and I can't wait to see what you come up with for *Mercenary II*. I'm also looking forward to all the excited correspondence that your letters seem to provoke, with other people filling in a few more pieces of the puzzle.

One person we have already heard from is Don Macleod of Dingwall who has a different point of view about *The Second City*. "The game is exactly like *Mercenary*, but in different colours, and there aren't any real puzzles aside from awkward map making. I enjoy mapping and found the world system of *SC* a novelty but by the time you have finished you are bound to have stumbled across the Novadrive.

"There may be interesting things behind the triangular doors but the game can be completed without finding out, so what's the point? I doubt whether many people try to solve puzzles for their own sake, particularly when it is not clear that they are really puzzles at all!"

Despite Don's strong opinions he sent in another excellent map which we couldn't use because we already had Chris's more complete version. However, thanks for the effort Don, and anything you can produce on *Tau Ceti* or *Psi 5* will be very welcome.

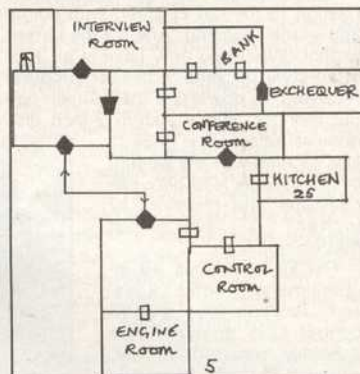
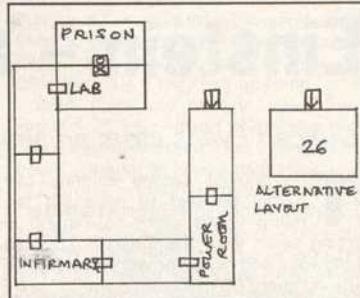
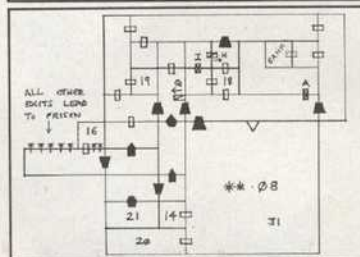
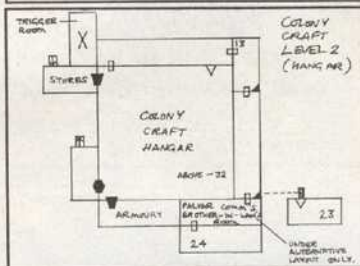
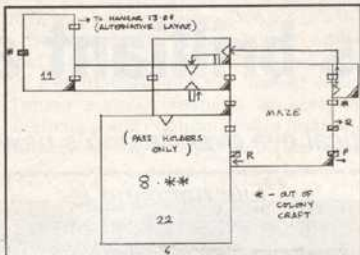

HI-VOLTAGE

London's Largest Specialist Amstrad Dealer

NEW PC HARDWARE AND LOW COST SOFTWARE CATALOGUE JUST PRINTED - PHONE FOR YOUR FREE COPY.

HI-VOLTAGE SPECIAL AMSTRAD PC PACKAGES

WORD-PROCESSING	DESKTOP PUBLISHING	ACCOUNTS
inc Wordstar 1512 Software and Daisy Wheel Printer	inc Fantasy Software and NLQ Dot Matrix Printer	inc M.A.P. Software and NLQ Dot Matrix Printer
From £599	From £639	From £699
+ VAT	+ VAT	+ VAT

Official orders welcomed from PLC's, government and education establishments

HI-VOLTAGE

53-59 High Street, Croydon, Surrey CR0 1QD. Tel: 01-681 3022
Mail Order Hot Line Phone 01-686 6362

The new Amstrad PC range
(IBM Compatible)

IN STOCK NOW

Prices from

£399 + VAT

Hard Disk Models from £699 + VAT

PART EXCHANGE YOUR PCW 8256 or PCW 8512 FOR THE NEW AMSTRAD PC. PHONE FOR PRICES



Prices correct at copy date. Subject to change without notice. E.S.O.E.

Einstein - as brilliant as the man?

Duncan Evans casts an analytical eye over Tatung's newest

The original Tatung Einstein can hardly be said to have set the micro world alight so Tatung is trying again with the Einstein 256, an upgraded and higher powered version of the original Z80 machine.

Physically, the new machine bears no relation to the old Einstein, with colour and shape changing. And for the better, at that. What you now have is an Amstrad-style package with the computer receiving its power via the 14-inch colour monitor, and a built-in 3-inch disc drive as before. One gripe to kick off with was the amount of non-flexible lead between computer and monitor; 17 inches is somewhat restraining.

The keyboard has 48 alphanumeric/graphic keys, eight function keys and 13 control keys arranged in a generally standard manner, although the right hand side gives the impression of being squashed in. Thankfully though, the cursor keys are in a cluster on their own. As far as quality goes the keyboard has a slightly cheapish feel to it but that in no way prohibits its use.

A reset button, beyond the on/off button on the monitor, is conspicuous by its absence but pressing *Alpha Lock*, *Ctrl* and *Graph* at the same time produces the desired effect. So long as the software programmers haven't disabled them, of course.

On the interface front the new machine has notably fewer sockets and plugs than before, seven in total. These are the Vamp (Video, mouse and light pen) edge connector, monitor/power, audio out, cassette interface, RS232 and two joystick ports. The joysticks are configured to accept a nine-pin D plug and also, and most surprisingly, they double as a Centronics printer interface or user port! The ports may look like they'll accept Atari style joysticks but unfortunately they didn't work with any of the free games supplied in the package.

Powering up the Einstein 256 reveals that this is a 'clean' machine. The master disc must be inserted and *Ctrl-Break* pressed to boot the Tatung version of CP/M. 'Aha!' I hear you say, 'CP/M and 3 inch discs! Won't this load PCW programs, then?' The answer to that is, unfortunately, no. Or not yet anyway.

Tatung is working on a piece of software to enable you to run Amstrad CP/M

"File handling is allocated an acceptable number of commands, one of which, Append, allows you to write additional information to the end of a sequential file"



The new look of Einstein

programs. When it comes up with a fully working program, as opposed to the one shown at the PCW show, it should enhance the Einstein's commercial viability by a not inconsiderable degree.

Once you've loaded up the Einstein's Basic, called Ebasic appropriately enough, you will discover that you have only 41852 bytes of memory to program in. What about the rest of the 256K lurking beneath the machine's bonnet? Well, 192K is allocated to the video chip and the Rom has 16K of the CPU's 64K.

With such a whopping great amount of video Ram available you would expect the machine to be capable of some pretty stunning graphics.

Well, on paper, it's capable of producing a 256 by 212 pixels bit-mapped screen in 256 colours or 512 by 212 pixels in 16 colours from 512. Needless to say these modes gobble up the video Ram and are not compatible with the old Einstein.

There are a total of 10 different modes

which juggle resolution, colours available, active sprites and video Ram used. When used in 80 columns, the monitor gives a reasonable display which is perfectly readable for wordprocessing.

Sound output is provided by a 1 watt rms speaker located at the bottom left of the monitor. This is monophonic but there is also a stereophonic output, a 3.5mm jack which can drive low impedance headphones.

The sound generator itself has three music channels and one noise channel in the manner of the BBC B and Amstrad CPC machines.

And so to Ebasic, the Einstein's version of Basic. Once you've loaded it up you will discover that you have only 41852 bytes of memory to program in. Advocates of structured programming will not be happy with this marginally improved version of the old Einstein Basic as it supports only an *If... Then... Else...* construct. No procedures, no *Repeats-Untils* and no *While-Wends*. *Gosub* and *Goto* are present of course.

The graphic commands available are reasonably comprehensive allowing ellipses (actually they're fixed shape squashed circles), points, lines and polygons with varying numbers of sides to be drawn. These are all outlines of the shapes but there is a *Fill* command so solid shapes are easily attainable.

Where the graphics do go beyond the norm is in the provision of hardware sprites and the commands to control them. The shapes are defined using grids of eight by eight or 16 by 16 pixels and can be expanded by use of the *Mag* command. There are 32 sprites available in all but there is the limitation or how many you can have on any particular screen line. In Multi-colour and Graphics one and two modes, only four are permissible while in the other graphic modes (not compatible with the old Einstein) you can have eight.

The sound commands consist of *Beep*, *Music*, *PSG*, *Tempo* and *Voice* enabling you to play simple tunes very easily. To get anything more out you have to put correspondingly more in.

File handling is allocated an acceptable number of commands, one of which, *Append*, allows you to write additional information to the end of a sequential file, thus avoiding the tedium of opening

it first and reading through till the end. String handling gets the usual *Left\$, Right\$* and *Mid\$* although there is no *Instr\$* style command for searching the contents of strings. One interesting ability is that of assigning an entire screen of text into a string which can be

then manipulated, using *Scrn\$*. Documentation is usually something that manufacturers think about last of all (cf Commodore) but the manual which Tatung supplies features all sorts of interesting and comprehensive facts and details. For the really technical stuff

there's a fair amount of wading to be done to get to the nitty gritty and some things are uncomfortably vague but otherwise it's a very helpful tome.

Well, there you have it. The Tatung Einstein 256 has good graphics potential, reasonable sound and average keyboard - a neat all in one package.

The only problem is that it's competing in the heart of Amstrad territory with a small business/games machine design. With the release of the Amstrad PC 1512 in exactly the same market the Einstein 256 will be very hard pressed to compete on the same terms.

If it's less of a games machine and more of a serious machine you're after then there's the well established PCW 8256/8512s. And going the other way the CPC 6128, with the same system components as the Einstein, has a more games-related software base.

The Einstein 256 is a good machine but unless Tatung commissions some outstanding software to make use of the extra memory and graphics potential, and I mean the sort of outstanding that gets people talking about it, then I can't see it competing at this price with the plethora of Amstrad machines.

Below: close-ups of the Einstein 256 interfaces

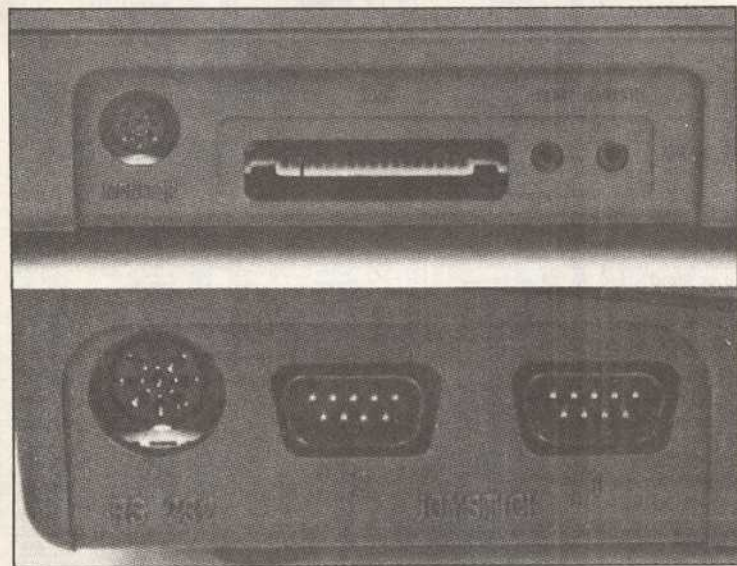

Product Einstein 256 **Price** £399
Supplier Tatung (UK) Ltd, Stafford Park 10, Telford, Shropshire TF3 3AB.

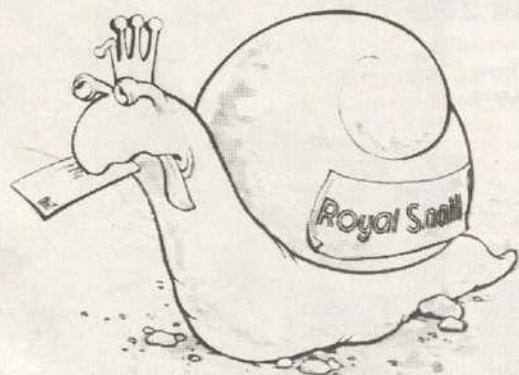

**There is
an alternative...**

Electronic Mail

For Telex, on-line games, Prestel, Telecom Gold, Easylink, home banking, cheap holidays etc.

The Enterprise range of BABT approved modems offers you V21(300 BAUD), V23(1200/75) and for Enterprise 2, V22 (that's right 1200 BAUD FULL DUPLEX).

We can offer them complete with an extensive range of top class software to support the auto dial/auto answer functions, viewdata etc. all at incredibly low prices.

In the words of Micronet 800 "As far as value for money is concerned, Enterprise 1 and 2 from Kirk Automation are it!"

PRICES

Enterprise 1 - £99.95 + VAT (£114.95)
 Enterprise 2 - £249.95 + VAT (£287.45)

**KIRK'S
ENTERPRISE
The Space Age
Alternative**

Comms Packs (including Enterprise 1, Software, Interface, Leads, instructions etc).

- ▶ Amstrad PCW8256/8512 £199.95 + VAT (total £229.42)
- ▶ Amstrad CPC 464/664/6128 £129.95 + VAT (total £149.45)
- ▶ IBM + Compatibles (IN PC1512) £199.95 + VAT (total £229.42)
- ▶ QL £149.95 + VAT (total £172.45)
- ▶ Spectrum (all models) £149.95 + VAT (total £172.45)
- ▶ BBC B/Master £119.95 + VAT (total £137.95)
- ▶ Atari ST (All versions) £119.95 + VAT (total £137.95)
- ▶ Atari 400/800/130XL (Prestel only) £139.95 + VAT (total £160.95)
- ▶ Commodore 64/128 £139.95 + VAT (total £160.95)
- ▶ Apricot FI, PC + X £199.95 + VAT (total £229.42)

OTHER VERSIONS AVAILABLE POA

All cheques etc. payable to **Kirk Automation Limited**
 Bridge Works, St. Whites Road, Cinderford, Glos. GL14 3HB
 Telephone: 0594 22084 **Access, Visa and Amex**

KIRK

NOBLES COMPUTER REPAIRS

* Repairs carried out by our own engineers
 * All repairs carry a 4-MONTH GUARANTEE
 For estimates phone or send your computer to NOBLES Spectrum Plus..... **£16.95** inc parts post and pack

Commodore 64/Vic 20..... from **£9.95** plus parts

Amstrad..... from **£18.95** plus parts

Also repair specialists for MSX computers

NO HIDDEN CHARGES

★ SPECIAL OFFER

5 FREE GAMES WORTH £25

with each Spectrum repair – Trade/School and Club discounts arranged

* For free, no obligation estimates phone or send your computer to NOBLES for the fastest, cheapest repairs in ESSEX.

NOBLES

14-17 Eastern Esplanade

Southend-on-Sea

Essex

0702 63377/8

63336/7/8/9

7 days a week, 24-hour Answering Service

ANCIENT & MODERN

Unit 111 (Rear), Washington Road, West Wilts Trading Estate, Westbury, Wilts

SPECTRUM	ref	ASM	COMMODORE 64	ref	ASM	ref	ASM	
Paperboy	7.95	1.99	Paperboy	6.90	10.90	Graphic Adv. Creator	22.95	14.95
Dan Dare	9.95	6.95	Actar	6.90	10.50	Music System	14.95	9.95
Dragon's Lair	7.95	4.99	Blon Dier	6.90	N/A	Multimedia Draw	14.95	10.99
Graphic Adv. Creator	22.95	14.99	Dragon's Lair	6.90	N/A	Wrestle Sports	9.95	5.95
Ghost 'N Goblins	9.95	6.99	Super Cycle	6.90	N/A	Kropki Games	14.95	4.95
Heartland	9.95	6.90	W.A.R.	8.80	N/A	Rucky Horror Show (disc)	14.95	6.95
Atlantic Challenge	7.95	3.25	Go for Gold	2.60	4.25	Who Cares West II (disc)	14.95	6.99
Leoni Genus	14.95	9.99	Time Tunnel	4.95	5.99	Hyperwords (disc)	12.95	6.95
Two Joes	7.95	3.99	Heartland	4.95	3.99	V (disc)	14.95	7.99
Jack to the Future	9.95	1.65	Supercop	5.95	N/A	Highslide	9.95	5.99
Arc of Yessod	7.95	2.99	Canta Bakery	5.95	3.95	MSX	9.95	5.99
Pyrexia	9.95	2.99	Other US Gold	2.99	N/A	Konami Bowling	14.95	8.50
Zoids	1.99	1.65	Sagittal	4.95	N/A	Atlantic Adventure	14.95	9.50
Key Finked Silver	14.95	4.99	Yu Ai Rang Fu	8.90	9.99	Cozzer	14.95	6.50
Scrabble	7.95	2.99	Bonkball	6.90	8.99	Hyperwords I or 2	14.95	9.50
Killer Tomatoes	9.95	6.90	Shoulder	6.90	8.99	Track 'N' Field 1 or 2	14.95	9.50
Academy Hill of Fame	9.95	2.99	Fighting Warrior	4.95	8.99	The Seas	9.95	6.99
Tau Ceti	9.95	2.99	Frek	2.99	4.99	Samantha Fox	9.95	6.99
I of the Mask	9.95	3.99	Drumcage	6.90	8.99	Guidlight	9.95	6.99
Adventure Adventures	8.95	4.99	Ghost 'N' Goblins	6.90	9.99	ATAI	9.95	5.99
Amazon Women	7.95	3.99	Graphic Adv. Creator	14.99	15.99	Atari	9.95	5.99
Amstrad	1.95	4.99	Urion	7.95	9.99	Ballbuster	9.95	5.99
Shadowfax	9.95	2.99	Max Headroom	3.99	N/A	Smash Hits 1,2,3,4 or 5	9.95	4.99
Warrior	9.95	2.99	30 Games	4.95	N/A	Whirlwinders	9.95	4.99
Winer Games	2.95	4.99	Urion	7.95	9.99	Highlanders	9.95	2.99
Dynastie Dan II	7.95	4.99	Rock 'N' Wrestle	5.90	8.99	Real Moon	6.95	4.99
			Estalon	5.90	9.99	Axman	9.95	5.99

All prices include P & P. Overseas add 75p per tape please. Thousands of titles in stock. Please send SAE for full list stating machine. Lists also available for C16, Dragon, Electron, BBC, Vic 20.

Ancient & Modern

Unit 111 (Rear), Washington Road, West Wilts Trading Estate, Westbury, Wilts.

ED4D FREEPOST (no stamp required)

46 THE MALTINGS, STANSTEAD ABBOTS, WARE, HERTS SG12 8BR

SPECTRUM 48K	RRP	PRICE	OUR	RRP	PRICE	OUR	RRP	PRICE
Bobby Bearing	7.45	5.75	Room 10	9.95	6.99	Paradox	9.95	6.00
Caddion II	7.95	5.75	XARC	9.95	6.99	Arise	9.95	6.95
Starline Sport	9.95	6.99	Trivial Pursuit	14.95	11.50	Ultima 4	19.95	14.95
Heavy on the Magic	3.95	6.95	Dragon's Lair	7.95	5.75	Vlan	8.95	6.00
ACE	9.95	6.99	Dan Dare	9.95	6.99	Mission Elevator	9.95	6.99
Jack The Nipper	7.95	5.75	Heartland	9.95	6.99	Room 10	9.95	6.99
Graphic Adv. Creator	22.95	16.95	Nightmare Rally	7.95	5.75	Kingbomber	9.95	6.00
Green Beret	7.95	5.75	Madcoach	9.95	6.70	Super Cyclist	9.95	6.99
Kung Fu Master	7.95	5.75	S.F. Horror	9.95	6.99	Dan Dare	9.95	6.99
Squinox	9.95	6.99	Paper Boy	7.95	5.75	Mission A.D.	9.95	6.99
Soggett	7.95	5.75	Galvan	7.95	5.75	S.F. Horror	9.95	6.99
Lazer Genus	14.95	11.95	Highlander	7.95	5.75	Go For Gold	2.99	2.90
Petarcus	7.95	5.75	Footballer/Year	7.95	5.75	Trivial Pursuit	14.95	11.50
Slim Fox	8.95	6.00	COMODORE 64/128	8.95	6.00	Ishtar	9.95	6.99
Theatre Europe	7.95	5.75	Best of Beyond	9.95	6.99	It's A.K.O.	6.95	6.00
Galman	7.95	5.75	Moonshot	9.95	6.75	Highlander	9.95	6.00
Ghosts and Goblins	7.95	5.75	Trap	9.95	6.99	Allykat	9.95	6.99
Spinobly	9.95	6.99	Tau Ceti	7.95	5.75	Footballer/Year	9.95	6.99
Quasatron	8.95	6.50	Ghosts and Goblins	9.95	6.95	Dread	7.95	5.75
Mindstone	9.95	6.99	Knight Games	8.95	6.80	Best of Beyond	9.95	6.99
Atlantic Challenger	7.95	5.75	Solo Flight II	14.95	11.50	Gladiator	8.95	6.00
Alarm Vial	7.95	5.75	Green Beret	8.95	6.80	Asterix	9.95	6.80
Tarvos	7.95	5.75	Mercenary II	5.95	4.50	Arcovert (C)	14.95	11.99
Kingpin	7.95	5.75	Mercenary III	9.95	6.95	Mercenary Completion	14.95	11.99
Dynastie Dan II	7.95	5.75	Silent Service	9.95	6.95	Jack The Nipper	9.95	6.99
Johnny Reb II	9.95	6.99	Dragon's Lair	8.95	6.99	Smob	7.95	5.75
Pal Chess	9.95	6.99	Miami Vice	8.95	6.60	Hacker II	9.95	6.99
Navor	7.95	5.75						

All prices include free fast delivery to same day despatch, when available. Personal calls welcome. 5% discount on all orders for new or returning customers to a value over £45. Cheques/POs/ECs payable to ED4D. For up to date news on available & Access orders ring (0520) 870568. Send SAE for free lists.

FREE SOFTWARE...

Is what you get when you buy an Amstrad PCW, but how many people make the most of it? Now, for the first time, this double package from two of Britain's most experienced computer authors takes the lid off the PCW's hidden power:

- **WORD PROCESSING:** everything you always wanted to know about templates, layouts, standardised forms, odd-sized formats — from the ABC of LocoScript to the sophisticated techniques of the modern office
- **CP/M:** sensible working methods for a secure and efficient system
- **GSX:** complete details of how to get presentation-quality graphics from straightforward Basic programs
- **LOGO:** graphics and list processing for the first time user
- **BASIC:** your own suite of business programs including a database, accounts program, bank account record, invoice creator and many more.

Practical Amstrad Word Processing and The Amstrad Companion — 440 pages of ideas that will turn your PCW into the power house it was meant to be! You can obtain the books at only **£6.00 each** or an amazing price of **£10.00 for the two including p&p.**



To Theresa Lacy, Sunshine Books
 12/13 Little Newport Street
 London WC2H 7PP

Please send me _____ copies of practical Amstrad Word Processing and Amstrad Companion (both for £10 inc. p&p)

I enclose a cheque/postal order for £_____ payable to Sunshine Books
 Alternatively please debit my Visa Access American Express
 Account Number _____ Expiry Date _____
 Signed _____
 Name (capitals please)
 Address _____

Time for the game machines

Andy Pannell dissects the new Spectrum Plus 2

The new Spectrum Plus 2 is a nice improvement over the ordinary Spectrum 128 in most ways. The most obvious differences are that it's not black (it's grey) and the keyboard looks reasonable.

While the keyboard has exactly the same layout as the Spectrum Plus and 128 machines (except that the Extended key is bigger) it is much nicer to type on. It feels similar to the Amstrad range, for obvious reasons, though feels more cramped, and of course keys such as ; and ' are in the 'wrong' place. It's definitely better than any previous Sinclair keyboard and is good in all respects, except that most of the keywords used in 48K Basic are missing. The exceptions are the *Run*, *Load* and *Code* tokens. All the others have gone, including some non-tokens like | and ©.

The built-in cassette player is to the right of the keyboard, and makes loading and saving programs a whole lot easier, with no leads to muck about with and no fiddling of level controls. The machine is designed for the games market and to load a 128K game couldn't be easier - press Cursor down a couple of times to get to the *Tape Load* menu and press *Return*, and that's it. The white legends on the cassette buttons were wearing thin on the review machine and didn't look as if they'd last very long.

The machine has all of the sockets of the 128, including the standard Spectrum edge connector, reset switch, RS232/Midi socket, TV and RGB socket, but in addition offers a sound socket

for amplifiers (even though it comes through the TV as well) and two D-type joystick sockets. Unfortunately the pin-outs of these are entirely different to the standard, following the old Sinclair standard (as used on the Interface 2) rather than the more common Kempston or cursor-key formats. It would seem that compatible Sinclair joysticks will be bundled with the machine from at least some retailers.

Inside the case there is a completely new PCB, containing mainly familiar components. The cassette mechanism has a small PCB on it and connects via proper sockets. The quality of the keyboard connectors has also been improved by the designers at Brentwood. While the word 'Amstrad' doesn't occur at all on the outside of the machine, it can be found at least five times on the inside!

The Rom itself is in two parts - there's the copy of the original 48K Spectrum

programs that run in 48 mode on the 128 will work on the Plus 2. The 'new' part of it is slightly changed from the 128 version, because of an extended Amstrad copyright message and the removal of the 'Tape test' routine. Because of these changes some programs which access the new Rom directly in the 128 will not work unmodified on the Plus 2. The officially defined entry points have remained though, and games that have no need to call anything else and should work without any problems.

The Spectrum 128 has compatibility problems with quite a few 48K games, and these have not been fixed on the Plus 2, which is a great shame. It would have been an easy job to make the Plus 2 much more 48-compatible by removing some of the redundant code from the new part and replacing it with the code that causes the problems from the modified old Rom. Oh well, it's a bit late now.

In 48K mode most games should work, though older ones do have problems, but programming in 48K Basic is near impossible because all of the tokens have disappeared from the keyboard. Although I was surprised how well I could remember the positions of the more common tokens, even an old hack like me got stuck on the lesser ones and had to reach for a nearby Spectrum. Anyone who doesn't know the Spectrum keyboard very well can forget programming in 48K mode, and use the screen editor in 128K mode instead. It's better in most ways, and you don't need the tokens for it. The only snag it has is that it has a nasty habit of losing key presses just after running a program or a direct command.

All Sinclair add-ons, including the Microdrives work with the Plus 2, although unmodified third party add-ons will have problems if they have Roms. I was hoping to find some code in the Rom for a disc interface, but I was disappointed. It is rumoured that there will be an official Sinclair/Amstrad one at some point though, which would be good. The Spectrum really needs a standard disc interface that all programs can use, instead of the plethora of incompatible ones there are at the moment.

All in all the Plus 2 is a nice version of the Spectrum 128, and will run most games admirably. The built in cassette recorder is very useful, and the keyboard is definitely the best Sinclair production. The CPC464 and the ordinary Spectrum 128 look doomed.



The Spectrum Plus 2 keyboard

Rom and the extra one containing the screen editor and code to access the new hardware. The 'old' part of it is identical to its counterpart in the 128 except that the copyright message has been replaced with a very short '© 1982 Amstrad' and the Record message in the tape routines has been changed. Any

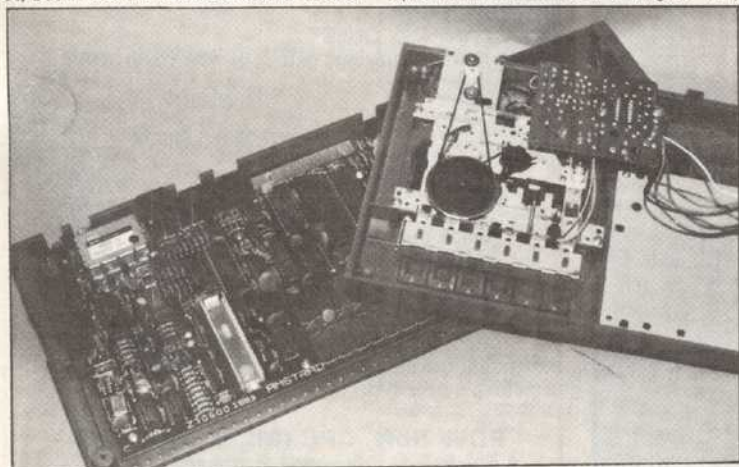

How did you manage without a macro?

Macro Manager is a desktop accessory program licensed by Robtek from the American company Shanner International Corporation.

The facilities offered are calculator, cards, events, alarms, notes, plan, report and type.

The calculator has 20 functions and the ability to print calculations as they are computed. However, most of the functions are fairly standard and provide most things you'd expect from a run-of-the-mill calculator. It has to be said that the one in *Cormerman* from Microdeal offers a good deal more than *Macro Manager* does. One original feature is the calculation of monthly payments based on information inputted.

Cards and events are essentially the same thing and enable you to define name, telephone number and three other fields of information. The cards can be sorted and printed, searched and replaced. Also, if you have a Hayes compatible modem,

there is an auto-dial facility.

The alarm function allows one or more alarms to be set up, with individual messages and repeat options. Assuming you leave your ST on all the time then you can be buzzed with the same message every week, month or year.

The notepad allows various messages to be scrawled down and stored on disc for later recall and possible printing. A maximum of four pages of text can be entered in one file.

The weekly planner function provides five lines of short text per day for each week defined and can also have important events flagged to the alarm system so that on the relevant day your ST will start bleating until some acknowledgement is received. Also available for use with the weekly planner is the time analysis report which enables you to identify how much time is spent on individual projects each week. Then, daily or weekly totals can be displayed and printed

out for a specified time period.

The last facility on offer is Macrotype which effectively turns your ST into a typewriter. All text entered is formatted, by centring, justification and tabs, and sent straight to the printer.

Surprisingly there are no fillers in *Macro Manager*, all the functions are actually useful and the memory overhead

starts at a reasonable 70K. If you're interested in this sort of program then this one can be heartily recommended.

Duncan Evans

Program Macro Manager
Micro Atari ST Price
£29.95 Supplier Robtek
 Limited, Unit 4, Isleworth
 Business Complex, St
 Johns Road, Isleworth,
 Middlesex. TW7 6NL.

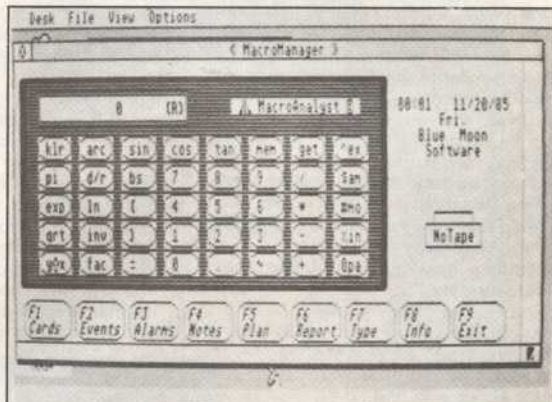

The truly useful executive toy

QL Owners!

Gilsoft are pleased to announce the launch of their famous Adventure Writing System The Quill for the QL. Now available in two forms

1. You supply the media. (ready formatted) either two microdrive cartridges, or one 3½/5¼ inch disc, manual is supplied as a file only.

£10.95

2. Complete package with printed manual and media supplied in presentation case.

£22.95

From: Gilsoft International Ltd.
 2 Park Crescent, Barry, S. Glam. CF6 8HD
 Tel: (0446) 732765

ACCESS and VISA welcome

AMSTRAD PCW8256/8512

LEISURE PROGRAMS

Four challenging strategy/simulation games from PCW Soft for only £9.95 each or £35.00 for all four.

1. FANTASY QUEST
A role playing game in the best D&D tradition.
2. MERCHANT
A 2-6 player trading game set in a fuel starved future.
3. MOUNTAIN LEADER
Have you got the organisational ability to reach the top?
4. SPECULATORS
Two to six players race to become millionaires.

Strategy and simulation games have become a traditional application of computers, now you can play them on the PCW's.

PCW Soft, CPC (Minehead) Ltd.
 4 The Parade, Minehead, Somerset TA24 5UF
 Tel: 0643 4851

Soccer

by Mark Slater

Part two of three of the listing follows this week as well as further instructions.

After you have selected which players are going in the team pressing 'P' starts the next match. Running commentary is given throughout until the final whistle when all the other results in the division are given.



Pressing the spacebar produces the updated league table. This sequence continues until the end of the season

when you receive a report of what will happen to your team next season (promotion, relegation etc).

1770COLOUR129:COLOUR0	2220PRINTTAB(1,2);"THE CHOICE OF TEAMS	-score1)
1780ENDPROC	IS:"	2640IFscore1>score2 THEN data(team,6)=d
1800REM**** PRINT DIVISION DATA ****	2230team3=-1	ata(team,6)+3:data(team,2)=data(team,2)+
1810	2240REPEAT	1:data(match,4)=data(match,4)+1
1820DEFPROCdivision	2250counter=0	2650IFscore2>score1 THEN data(match,6)=
1830PRINTTAB(7,3);"TEAM";TAB(16,3);"P1d	2260REPEAT	data(match,6)+3:data(match,2)=data(match
");TAB(20,3);"Won";TAB(24,3);"Drw";TAB(28	2270team3=team3+1	,2)+1:data(team,4)=data(team,4)+1
,3);"Lst";TAB(32,3);"GD";TAB(36,3);"Pts"	2280counter=counter+1	2660IFscore2=score1 THEN data(match,6)=
1840tab=2	2290PRINTTAB(12,counter+4);team3+1;",";	data(match,6)+1:data(team,6)=data(team,6
1850FORcount=1TO12	TAB(16,counter+4);league\$(team3);SPC(10))+1:data(team,3)=data(team,3)+1:data(mat
1860IFcount>9THENTab=1	2300UNTILcounter=12	ch,3)=data(match,3)+1
1870PRINTTAB(tab,3+(count*2));count	2310PROCspace	2670check=3
1880NEXTcount	2320UNTILteam3=47	2680check(1)=team:check(2)=match
1890FORcount2=0TO11	2330PRINTTAB(1,30);SPC(35)	2690REPEAT
1900IF order(count2,0)=team THEN PROCorder	2340INPUTTAB(3,18);"ENTER CHOICE";choic	2700team1=RND(12)-1
1910PRINTTAB(4,(count2*2)+5);team\$(orde	e\$	2710flag2=0
r(count2,0))	2350team=INT(VAL(choic\$))	2720FORloop=1TOcheck:IFcheck(loop)=team
1920PROCoff	2360IFteam<10Rteam>48THENPRINTTAB(1,20)	1 THEN flag2=1
1930FORcount3=1TO6);"ENTER A NUMBER FROM 1 TO 48";TAB(16,18	2730NEXTloop
1940PRINTTAB((count3*4)+12,(count2*2)+5);SPC(14);GOTO2340	2740IFflag2=1THEN2700
);data(order(count2,0),count3)	2370team=team-1	2750check(check)=team1:check=check+1
1950NEXTcount3	2380PRINTTAB(1,20);"THE TEAM YOU HAVE O	2760team2=RND(12)-1
1960NEXTcount2	HOSEN IS:"	2770flag3=0
1970ENDPROC	2390PRINTleague\$(team)	2780FORloop=1TOcheck:IFcheck(loop)=team
1990REM**** DRAW LINES ON TABLE ****	2400PRINTTAB(12,24);"IS THIS CORRECT"	2 THEN flag3=1
2000	2410REPEAT	2790NEXTloop
2010DEFPROCdraw	2420input\$=GET\$	2800IFflag3=1THEN2760
2020CLS	2430UNTILinput\$="Y" OR input\$="N"	2810check(check)=team2:check=check+1
2030division\$="Division "+STR\$(division	2440UNTILinput\$="Y"	2820league1=RND(5)-1
)	2450name\$=league\$(team)	2830league2=RND(5)-1
2040PROCdouble_height(division\$,15,1)	2460league\$(team)=league\$(36)	2840data(team1,5)=data(team1,5)+(league
2050GCOL0,0	2470league\$(36)=name\$	1-league2)
2060FORline=944TO112STEP-64	2480ENDPROC	2850data(team2,5)=data(team2,5)+(league
2070MOVE18,1line	2520DEFPROCspace	2-league1)
2080DRAW1262,1line	2530PRINTTAB(7,30);"PRESS 'SPACE' TO CO	2860IFleague1>league2 THEN data(team1,2
2090NEXTline	NTINUE")=data(team1,2)+1:data(team2,4)=data(tea
2100MOVE18,944:DRAW18,112	2540REPEATUNTILGET\$=" "	m,2,4)+1:data(team1,6)=data(team1,6)+3
2110MOVE110,944:DRAW110,112	2550ENDPROC	2870IFleague2>league1 THEN data(team2,2
2120FORline2=494TO1304STEP128	2570REM***** UPDATE DATA *****)=data(team2,2)+1:data(team1,4)=data(tea
2130MOVE1line2,944:DRAWline2,112	2580	m1,4)+1:data(team2,6)=data(team2,6)+3
2140NEXTline2	2590DEFPROCalter	2880IFleague1=league2 THEN data(team1,6
2150ENDPROC	2600y=13)=data(team1,6)+1:data(team2,6)=data(tea
2170REM**** ENTER TEAM CHOICE ****	2610FORcount5=0TO11:data(count5,1)=data	m,2,6)+1:data(team1,3)=data(team1,3)+1:da
2180	(count5,1)+1:NEXTcount5	ta(team2,3)=data(team2,3)+1
2190DEFPROCchoose_team	2620data(team,5)=data(team,5)+(score1-s	2890result1\$=team\$(team1)+" "+STR\$(leagu
2200REPEAT	core2)	ue1)+" "+STR\$(league2)+" "+team\$(team2)
2210CLS	2630data(match,5)=data(match,5)+(score2	2900tab1=17-LEN(team\$(team1))

Programming: BBC

<pre> 2910PROCdouble_height(result\$,tab1,y) 2920y=y+3 2930UNTILcheck=13 2940ENDPROC 2960REM*** SORT TEAMS INTO ORDER *** 2970 2980DEFPROCsort 2990FORcount7=0TO11:order(count7,1)=(data(count7,6)*1000)+data(count7,5):order(count7,0)=count7:NEXTcount7 3000flag=0 3010FORpass=0TO10 3020IForder(pass+1,1)>order(pass,1) THEN A=order(pass,0):B=order(pass,1):C=order(pass+1,0):D=order(pass+1,1):order(pass,0)=C:order(pass,1)=D:order(pass+1,0)=A:order(pass+1,1)=B:flag=1 3030NEXTpass 3040IFFlag=0THEN ENDPROC </pre>	<pre> 3050GOTO3000 3070REM***** TITLE PAGE ***** 3080 3090DEFPROCtitle_page 3100COLOUR129:CLS 3110VDU28,1,4,18,1 3120COLOUR131:CLS 3130VDU26 3140VDU19,0,4,0; 3150COLOUR0 3160PROCdouble_height("ELECTRON SOCCER!",2,3) 3170under_line\$=STRING\$(16,CHR\$(255)) 3180PRINTTAB(2,4);under_line\$ 3190VDU28,1,21,18,6 3200COLOUR131 3210CLS 3220PRINTTAB(1,1);"OPTIONS:" 3230under_line\$=STRING\$(8,CHR\$(255)) </pre>	<pre> 3240PRINTTAB(1,2);under_line\$ 3250COLOUR1 3260PROCdouble_height("1. Instructions",1,5) 3270PROCdouble_height("2. Choose Team",1,8) 3280PROCdouble_height("3. Start Game",1,11) 3290PROCdouble_height("4. End Program",1,14) 3300COLOUR128 3310COLOUR2 3320VDU28,1,30,18,23 3330CLS 3340PROCdouble_height("ENTER CHOICE",3,4) 3350VDU19,2,11;0; 3360ENDPROC </pre>
--	---	--

Programming: Spectrum

Ram Disc Utility

by D Garner

Using this program you can utilise the Spectrum 128's *Ram* disc. There are six options, as follows.

1 Transfer a Basic/machine code program or screen picture from tape onto the *Ram* disc.

2 Quits the program.

3 Allows you to load, in the normal way, a program or screen. Note that this option and option 1 use *Merge* so make sure that the program being loaded has line numbers under 9000.

4 Saves the current program in memory on to tape. When loading or saving machine code the start address and length has to be defined.

5 Displays a catalogue of the *Ram* disc to the screen.

6 Displays the same catalogue as above but to the printer using the *Copy* command.

If you don't wish to type the program in then send £1.75 for a tape to D Garner, 57 Lovers Walk, Dunstable, Beds LU5 4BG.

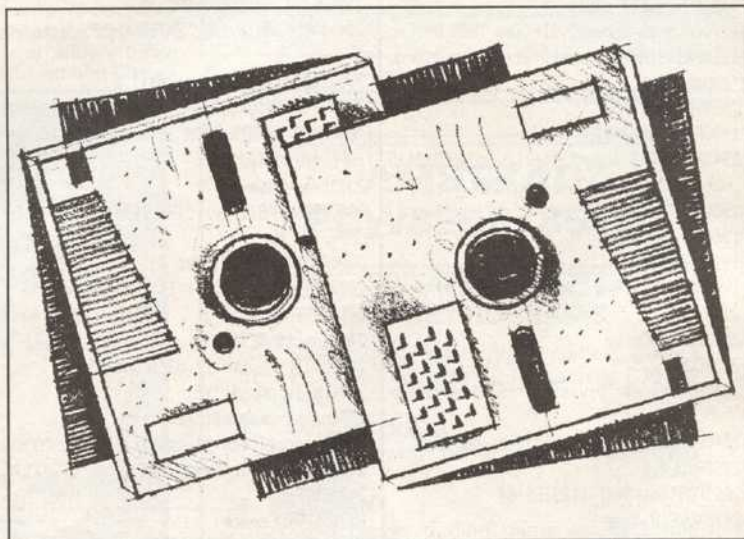

<pre> 9000 REM ***** 9005 REM *RAM DISC UTILITY* 9010 REM *FOR SPECTRUM 128* 9020 REM *BY DANIEL GARNER* 9025 REM * SPECTRUM 128 * 9030 REM ***** 9040 BORDER 6: INK 6: PAPER 2: CLS 9050 PRINT AT 1,10;"SPECTRUM 128" 9060 PRINT AT 2,12;"RAM DISC" 9065 PRINT AT 3,12;"UTILITY." 9070 PRINT AT 5,2;"OPTIONS" 9080 PRINT AT 7,3;"1 . TAPE TO RAM TRANS </pre>	<pre> FER" 9090 PRINT AT 9,3;"2 . QUIT THE PROGRAM" 9100 PRINT AT 11,3;"3 . LOAD PROGRAM FROM TAPE" 9110 PRINT AT 13,3;"4 . SAVE PROGRAM TO TAPE" 9120 PRINT AT 15,3;"5 . CATALOGUE (SCREEN)" 9130 PRINT AT 17,3;"6 . CATALOGUE (PRINTER)" 9140 LET A#=INKEY\$: IF A#="" THEN GO TO 9140 </pre>	<pre> 9150 IF A#("1" OR A#)"6" THEN GO TO 9140 0 9160 LET A=VAL A#: 9162 IF A=1 THEN GO TO 9200 9164 IF A=2 THEN STOP 9165 IF A=3 THEN GO TO 9450 9170 IF A=4 THEN GO TO 9600 9175 IF A=5 THEN LET PRINTER=0: GO TO 9750 9180 IF A=6 THEN LET PRINTER=1: GO TO 9780 </pre>
--	---	--

```

9200 CLS : PRINT AT 1,5;"TAPE TO RAM TRA
NSFER"
9210 PRINT AT 5,2;"ENTER PROGRAM TYPE"
9220 PRINT AT 7,3;"1 . BASIC PROGRAM"
9230 PRINT AT 9,3;"2 . SCREEN#"
9240 PRINT AT 11,3;"3 . MACHINE CODE"
9250 LET A#=INKEY$: IF A#="" THEN GO TO
9250
9260 IF A#"1" OR A#"3" THEN GO TO 925
0
9270 LET A=VAL A#
9275 IF A=1 THEN GO TO 9300
9280 IF A=2 THEN GO TO 9330
9285 IF A=3 THEN GO TO 9370
9300 MERGE ""
9305 INPUT "NAME OF PROGRAM (UPTO 10 CHA
RS) "; LINE N#
9310 IF LEN N#>10 THEN GO TO 9305
9315 SAVE I N#
9320 GO TO 9000
9330 LOAD ""SCREEN#
9340 INPUT "NAME OF SCREEN (UPTO 10 CHAR
S) "; LINE N#
9345 IF LEN N#>10 THEN GO TO 9340
9350 SAVE I N#SCREEN#
9360 GO TO 9000
9370 GO SUB 9700
9390 LOAD ""CODE S,L
9395 INPUT "NAME OF CODE (UPTO 10 CHAR#)
"; LINE N#
9400 IF LEN N#>10 THEN GO TO 9395

```

```

9405 SAVE I #CODE S,L
9410 GO TO 9000
9450 CLS : PRINT AT 1,5;"LOAD A PROGRAM
FROM TAPE"
9460 PRINT AT 5,2;"ENTER PROGRAM TYPE"
9465 PRINT AT 7,3;"1 . BASIC PROGRAM"
9470 PRINT AT 9,3;"2 . SCREEN#"
9476 PRINT AT 11,3;"3 . MACHINE CODE"
9480 LET A#=INKEY$: IF A#="" THEN GO TO
9480
9490 IF A#"1" OR A#"3" THEN GO TO 948
0
9495 LET A=VAL A#
9500 IF A>1 THEN GO TO 9505
9501 MERGE ""
9503 STOP
9505 IF A=2 THEN GO TO 9520
9510 IF A=3 THEN GO TO 9540
9520 LOAD ""SCREEN#
9530 INPUT "PRESS ENTER TO CONTINUE":A#
9535 BEEP .5,4: GO TO 9000
9540 GO SUB 9700
9550 LOAD ""CODE S,L
9560 GO TO 9000
9600 CLS : PRINT AT 1,5;"SAVE PROGRAM TO
TAPE"
9605 PRINT AT 5,2;"ENTER PROGRAM TYPE"
9610 PRINT AT 7,3;"1 . BASIC PROGRAM"
9615 PRINT AT 9,3;"2 . MACHINE CODE"
9620 LET A#=INKEY$: IF A#="" THEN GO TO
9620

```

```

9625 IF A#"1" OR A#"3" THEN GO TO 962
0
9630 LET A=VAL A#
9635 IF A=2 THEN GO TO 9670
9640 INPUT "AUTORUN LINE (0=NO AUTORUN)
";L
9645 INPUT "PROGRAM NAME (UPTO 10 CHARS)
"; LINE N#
9650 IF LEN N#>10 THEN GO TO 9645
9655 IF L=0 THEN SAVE N#: GO TO 9000
9660 SAVE N# LINE L: GO TO 9000
9670 GO SUB 9700
9676 INPUT "CODE NAME (UPTO 10 CHARS) ";
LINE N#
9680 IF LEN N#>10 THEN GO TO 9676
9685 SAVE N#CODE S,L
9690 GO TO 9000
9700 INPUT "START ADDRESS OF CODE : ";S
9705 IF S<0 OR S>65535 THEN GO TO 9700
9710 INPUT "LENGTH OF CODE : ";L
9715 IF L<0 OR L>65535 THEN GO TO 9710
9720 RETURN
9750 CLS : PRINT AT 1,8;"CATALOGUE"
9760 PRINT AT 5,0;"FILES IN MEMORY : ";
PRINT AT 8,0;"": CAT !
9765 IF PRINTER=1 THEN COPY : LET PRINT
ER=0: GO TO 9000
9770 INPUT "PRESS ENTER TO CONTINUE "; L
INE P#
9775 LET PRINTER=0: GO TO 9000
9780 LET PRINTER=1: GO TO 9750

```

Programming: C64

Minz

by Ken Smith

And finally, this week sees part three of the listing. If you destroy all fifteen targets on a screen you move on to the next and are presented with a different set to blast.

If you would like a fast load copy on cassette send £2 to 73 Wakefield Street, East Ham, London E6 1NR.

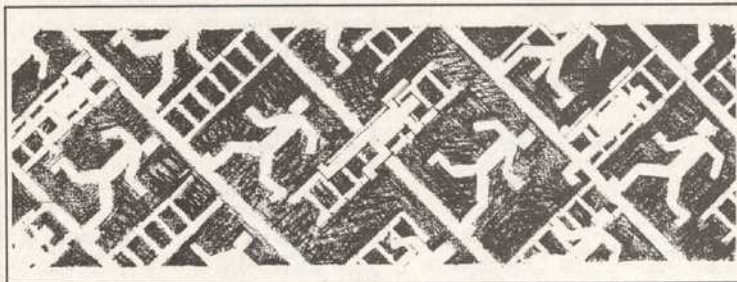

```

21326 DTR188,152,169,46,133,251,133,253,169,64,133,2,32,243,151,169,252
21327 DTR133,251,133,253,169,64,133,2,32,243,151,230,252,230,254,169,94
21328 DTR133,251,133,253,169,64,133,2,32,243,151,169,118,133,251,133,253
21329 DTR169,64,133,2,32,243,151,230,252,230,254,169,6,133,251,133,253
21330 DTR169,74,133,2,32,56,152,96,234,168,0,155,2,145,251,169,13
21331 DTR145,253,230,2,200,192,3,206,241,168,40,169,69,133,2,165,2
21332 DTR145,253,169,13,145,253,198,2,200,192,43,206,241,168,0,169,70
21333 DTR145,253,169,13,145,253,96,234,168,0,169,2,145,251,169,5,145
21334 DTR253,230,2,200,192,3,206,241,96,234,168,0,165,2,145,251,169,1
21335 DTR110,145,253,200,192,3,206,241,96,234,168,0,165,2,145,251,169,10,145
21336 DTR253,200,192,50,206,243,96,234,168,0,165,2,145,251,169,4,145
21337 DTR253,200,192,10,206,243,96,234,168,0,165,2,145,251,169,15,145
21338 DTR253,230,2,200,192,2,200,241,168,40,165,2,145,251,169,3,145
21339 DTR253,230,2,200,192,42,200,241,96,234,234,234,169,30,141,5,220
21340 DTR141,50,157,169,0,141,32,200,141,91,156,141,33,200,133,232,141
21341 DTR107,156,141,109,156,141,103,156,133,253,133,254,133,251,141,5,212
21342 DTR169,2,141,30,200,141,42,200,169,3,141,44,200,169,5,141,34
21343 DTR200,169,0,141,30,200,141,40,200,141,15,212,141,12,212,169,15
21344 DTR141,24,212,169,255,141,200,169,7,141,37,200,141,43,200,141
21345 DTR1212,169,6,141,41,200,141,46,200,141,30,200,141,45,200,169
21346 DTR143,141,240,142,169,37,141,249,145,169,248,141,21,200,169,25,141
21347 DTR16,212,141,19,212,169,120,141,0,212,169,45,141,29,212,169,20
21348 DTR141,24,212,169,96,141,19,212,169,200,141,0,212,169,100,141,7
21349 DTR12,169,4,141,101,156,173,22,200,9,16,141,22,200,234,169,147
21350 DTR32,210,205,169,162,133,251,169,0,16,141,2,173,161,156,105,4
21351 DTR133,252,174,18,200,169,99,157,201,20,176,246,133,253,32,69,156

```

```

21352 DTR174,18,200,189,99,157,201,39,176,246,133,254,24,166,253,164,254
21353 DTR32,240,205,165,251,32,210,255,198,252,200,212,234,173,81,156,201
21354 DTR169,200,10,169,0,141,81,156,169,49,141,85,157,173,81,156,200
21355 DTR16,32,161,147,75,231,153,201,1,200,6,32,17,140,75,231,153
21356 DTR201,2,200,6,32,125,148,76,231,153,201,3,200,6,32,233,148
21357 DTR176,231,153,201,4,200,6,32,98,149,76,231,153,201,5,200,6
21358 DTR32,193,149,76,231,153,201,6,200,6,32,101,150,76,231,153,201
21359 DTR17,200,6,32,252,150,76,231,153,201,0,200,3,32,117,151,169
21360 DTR16,141,16,200,174,81,156,160,65,156,162,0,185,119,156,157,251
21361 DTR143,105,167,156,240,6,13,16,200,141,16,200,200,232,224,5,200
21362 DTR233,174,81,156,180,92,156,162,0,185,212,156,157,6,200,200,232
21363 DTR224,10,200,244,234,169,32,141,16,212,169,254,45,21,200,141,21
21364 DTR200,162,0,169,46,157,157,0,140,169,7,157,0,212,232,224,40
21365 DTR200,240,169,0,133,251,133,252,133,253,133,254,169,171,141,4,200
21366 DTR169,221,141,5,200,169,32,141,250,143,169,251,45,16,200,141,16
21367 DTR200,169,4,13,21,200,141,21,200,169,14,141,32,200,141,33,200
21368 DTR32,70,156,32,70,156,32,70,156,32,70,156,32,70,156,32,70,156,32,70
21369 DTR156,32,70,156,32,70,156,32,70,156,32,70,156,32,70,156,32,70,156,32,70
21370 DTR200,45,30,200,141,30,200,169,0,45,31,200,141,31,200,32,231
21371 DTR144,162,2,173,30,200,41,4,240,3,76,8,155,173,31,200,41
21372 DTR14,240,3,76,8,155,173,30,200,201,3,200,8,162,0,200,18
21373 DTR12,76,8,155,201,10,200,9,162,3,200,107,156,76,8,155,201
21374 DTR18,200,8,162,4,230,107,156,76,8,155,201,34,200,8,162,5
21375 DTR200,107,156,76,8,155,201,56,200,8,162,6,230,107,156,76,8
21376 DTR155,201,130,230,8,162,7,230,107,156,76,8,155,76,164,154,32
21377 DTR244,144,169,35,157,246,143,169,129,141,4,212,169,120,141,4,212

```

Ram Disc

by Brian Cadge

The Amstrad 6128 (or other CPC's with added memory) features banked Ram which can be utilised by implementing a Ram disc, which is what this program does.

To make use of the Ram disc, after entering, correcting and moving the listing, type in *Ramdisc*. All file handling commands will then be directed towards the Ram disc. To return to Amsdos type *Disc*.

There are a few differences in operation from normal Amsdos. *Ram* disc filenames can be up to 10 characters long and can include any Ascii character. The *Ram* disc directory has space for 20 entries so if this number is exceeded an error report will be generated.

To erase a file use *Kill*, "program" on a 6128 and 664.

The banked *Ram* is switched in and out at address 16384 by the program. Interrupts are not disabled so you cannot have an interrupt running in the address space 16384 to 32767.

```

10 '
20 ' RAMDISC Basic Loader Program for 12
8K CPC's
30 '
40 SYMBOL AFTER 256:MEMORY 41200
50 ON ERROR GOTO 150
60 I=160:FOR J=41201 TO 42641 STEP 20
70 I=0:FOR J=0 TO 19
80 READ a$:v=VAL("%"+a$)
90 c$=c$+v:I=I+v:POKE I+J,v
100 NEXT J:READ c$:IF c$<>" THEN PRINT"
DATA ERROR IN LINE":I:CHR$(7):STOP
110 I=I+10
120 NEXT J
130 IF c$<>"185721 THEN PRINT"DATA ERROR
- Check listing":CHR$(7):STOP
140 CALL 41201:PRINT"RAMDISC installed":
END
150 PRINT"DATA ERROR around line":I:CHR
$(7):STOP
160 DATA C3,EC,A1,F5,C5,3E,C0,01,00,7F,E
D,79,C1,F1,C9,F5,C5,F6,C4,01,3294
170 DATA 00,7F,ED,79,C1,F1,C9,F5,C5,47,3
E,20,CD,5A,BB,78,06,00,FE,0A,2599
180 DATA 38,05,04,06,0A,18,F7,4F,78,FE,0
0,20,04,3E,20,18,02,06,30,CD,1620
190 DATA 5A,BB,79,06,30,CD,5A,BB,C1,F1,C
9,E5,D5,11,AD,A6,48,06,0A,3E,2709
200 DATA 20,12,13,10,FC,01,11,AD,A6,7E,1
2,23,13,10,FA,D1,E1,C9,78,B7,2160
210 DATA 28,34,FE,0B,38,02,06,0A,CD,38,A
1,D5,AF,CD,00,A1,11,00,40,06,1694
220 DATA 14,C5,D5,21,AD,A6,06,0A,1A,BE,2
0,0B,13,23,10,F8,E1,C1,EB,D1,2257
230 DATA 37,18,0C,D1,01,14,00,EB,09,EB,C
1,10,E0,D1,AF,CD,F4,A0,C9,7E,2553
    
```

```

240 DATA FE,FF,C8,CD,EA,B3,23,18,76,E5,7
0,EE,C0,CB,17,CB,17,CB,17,CD,3154
250 DATA 00,A1,70,E6,3F,76,40,67,7E,CD,F
4,A0,E1,C9,E5,F5,70,E6,C0,CB,3375
260 DATA 17,CB,17,CB,17,CD,00,A1,70,E6,3
F,F6,40,67,F1,77,CD,F4,A0,E1,2865
270 DATA C9,F5,CD,03,B9,32,A7,A6,CD,09,B
9,32,A8,A6,F1,C9,F5,3A,A8,A6,3084
280 DATA CD,0C,B9,3A,A7,A6,CD,0C,B9,F1,C
9,21,00,40,22,A2,A6,06,14,AF,2297
290 DATA CD,00,A1,3E,FF,11,14,00,77,19,1
0,FC,CD,F4,A0,AF,21,90,01,22,2128
300 DATA 92,A6,32,A5,A6,32,A6,A6,32,A4,A
6,01,1E,A2,21,A9,A6,CD,D1,8C,2618
310 DATA C9,26,A2,C3,32,A2,C3,E0,A5,52,4
1,4D,44,49,53,C3,4B,49,4C,CC,2463
320 DATA 00,06,0D,DD,21,59,A2,FD,21,73,A
2,DD,6E,00,DD,66,01,36,C3,23,2026
330 DATA FD,7E,00,77,23,FD,7E,01,77,DD,2
3,DD,23,FD,23,FD,23,10,E4,C9,2565
340 DATA 77,BC,7A,BC,7D,BC,80,BC,83,BC,8
6,BC,89,BC,8C,BC,8F,BC,92,BC,3205
350 DATA 95,BC,98,BC,9B,BC,80,A2,1F,A3,2
E,A3,30,A3,5C,A3,8D,A3,9E,A3,2817
360 DATA 80,A3,3A,A4,9A,A4,AF,A4,FC,A4,5
D,A5,3A,A5,A6,B7,20,1D,CD,53,2813
370 DATA A1,38,1B,21,A0,A2,CD,90,A1,AF,C
9,0D,0A,42,61,64,20,63,6F,6D,2122
380 DATA 6D,61,6E,64,0D,0A,FF,AF,3C,C9,3
E,03,32,A5,A6,7C,E6,3F,67,CD,2301
390 DATA 9A,A1,D5,DD,E1,DD,77,12,23,CD,9
A,A1,DD,77,15,23,CD,9A,A1,DD,3024
400 DATA 77,16,23,CD,9A,A1,AF,DD,71,18,2
3,CD,9A,A1,47,DD,70,19,23,CD,2357
410 DATA 9A,A1,DD,77,1A,32,9C,A6,23,CD,9
A,A1,DD,77,1B,32,9D,A6,ED,43,2652
420 DATA 94,A6,C5,23,CD,9A,A1,AF,23,CD,9
A,A1,47,ED,43,98,A6,EB,CD,CE,3039
430 DATA A1,DD,5E,15,DD,56,16,C1,F6,FF,D
D,7E,12,37,CD,DD,A1,C9,3A,A5,2951
440 DATA A6,B7,20,06,3E,00,32,A5,A6,C9,3
7,18,F7,18,F5,E5,3A,A5,A6,B7,2427
450 DATA 28,21,3E,01,32,A5,A6,2A,94,A6,7
C,B5,28,15,2B,22,94,A6,2A,98,1824
460 DATA A6,CD,9A,A1,23,22,98,A6,6F,F6,F
F,7D,37,E1,C9,F6,FF,18,FA,3A,3124
470 DATA A5,A6,FE,03,20,27,3E,02,32,A5,A
6,ED,4B,94,A6,ED,5B,98,A6,78,2496
480 DATA B1,28,0B,0B,EB,CD,9A,A1,23,EB,7
7,23,18,F1,ED,43,94,A6,2A,9C,2499
490 DATA A6,F6,FF,37,C9,F6,FF,C9,E5,2A,9
8,A6,2B,22,98,A6,2A,94,A6,23,3000
500 DATA 22,94,A6,E1,C9,3E,01,32,A5,A6,E
5,2A,94,A6,7C,B5,28,AD,F6,FF,2822
510 DATA 37,E1,C9,3A,A6,A6,87,D2,B0,A2,C
D,53,A1,30,1C,21,04,A3,CD,90,2852
520 DATA A1,AF,C9,DD,0A,45,69,6C,65,6E,6
1,6D,65,20,65,78,69,73,74,73,2065
530 DATA 0D,0A,FF,3E,03,32,A6,A6,CD,EF,A
3,EB,22,9E,A6,E5,DD,E1,DD,36,2875
540 DATA 12,16,F6,FF,37,C9,3A,84,A6,FE,1
4,28,25,AF,CD,00,A1,D5,01,0A,2301
550 DATA 00,21,AD,A6,ED,5B,A2,A6,ED,03,3
E,16,12,01,2A,92,A6,22,9A,A6,2460
560 DATA 21,00,00,22,96,A6,CD,F4,A0,C9,E
1,21,27,A4,CD,90,A1,AF,CD,F4,2798
570 DATA 40,C9,0D,0A,44,69,72,65,63,74,6
F,72,79,20,66,75,6D,6C,0D,0A,1823
580 DATA FF,3A,A6,A6,B7,23,08,F6,FF,3E,0
0,32,A6,A6,C9,AF,CD,00,A1,2A,2597
590 DATA 96,A6,7C,B5,28,47,DD,2A,A2,A6,D
D,75,DD,DD,74,0E,2A,92,A6,DD,2600
600 DATA 75,11,DD,74,12,DD,E5,CD,F4,A0,D
D,2A,9E,A6,DD,46,12,AF,CD,00,2824
610 DATA A1,78,DD,E1,DD,77,0A,2A,9A,A6,2
2,92,A6,3A,A4,A6,3C,32,A4,A6,2613
620 DATA 01,14,00,DD,09,DD,22,A2,A6,CD,F
4,A0,F6,FF,37,18,A8,AF,CD,00,2571
630 DATA A1,3A,A4,A6,FE,14,28,05,2A,A2,A
6,36,FF,CD,F4,A0,18,E6,E5,F5,2884
640 DATA 3A,A6,A6,FE,01,28,C9,FE,03,20,2
0,3E,01,32,A6,A6,2A,9A,A6,7C,1946
650 DATA B5,28,19,F1,CD,83,A1,23,22,9A,A
6,2A,96,A6,23,22,96,A6,E1,F6,2635
660 DATA FF,37,C9,F1,E1,F6,FF,C9,21,EB,A
4,CD,90,A1,F1,E1,AF,C9,DD,0A,3496
670 DATA 52,61,6D,64,69,73,63,20,66,7E,6
    
```

Programming: Amstrad 6128

C, 6C, 0D, 0A, FF, F5, 3A, A6, A6, FE, 2341	750 DATA 5A, BB, DD, 7E, 0E, CB, 3F, CB, 3F, 3C, 0	F, 28, 55, E5, DD, 5E, 07, DD, 56, 08, 2747
680 DATA 03, 20, 4D, 3E, 02, 32, A6, A6, F1, DD, 2	D, 0C, A1, 3E, 4B, CD, 5A, BB, 3E, 0D, 2302	830 DATA DD, 6E, 1B, DD, 66, 1C, ED, 4B, 92, A6, 0
A, 9E, A6, DD, 77, 12, F5, AF, CD, 00, 2369	760 DATA CD, 5A, BB, 3E, 0A, CD, 5A, BB, 01, 14, 0	D, 9A, A1, EB, CD, B3, A1, EB, 23, 13, 2922
690 DATA A1, F1, DD, 2A, A2, A6, DD, 77, 0A, DD, 7	0, DD, 09, 1A, 3C, 12, FE, 14, 29, BA, 1883	840 DATA 7A, BB, 20, F2, 7B, B9, 20, EE, E1, 54, 5
1, 0F, DD, 70, 10, DD, 75, 0B, DD, 74, 2727	770 DATA 0E, 0D, CD, 5A, BB, 3E, 0A, CD, 5A, BB, F	D, 01, 14, 00, 09, AF, CD, 00, A1, ED, 2368
700 DATA 0C, CD, F4, A0, ED, 53, 96, A6, 4B, 42, E	6, FF, 37, CD, F4, A0, CD, DD, A1, C9, 3064	850 DATA B0, E5, DD, 6E, 07, DD, 66, 0B, AF, ED, 4
B, 78, E1, 28, 15, 2A, 9A, A6, 7C, B5, 2658	780 DATA 0D, 0A, 52, 61, 6D, 64, 69, 73, 63, 20, 4	B, A0, A6, ED, 42, DD, 75, 07, DD, 74, 2872
710 DATA 28, 16, EB, E7, EB, CD, B3, A1, 23, 22, 9	4, 69, 72, 65, 63, 74, 6F, 72, 79, 3A, 1769	860 DATA 08, 01, 14, 00, DD, 09, E1, 3E, FF, 12, 0
A, A6, 13, 0B, 18, E7, F6, FF, 37, C9, 2739	790 DATA 0D, 0A, FF, FE, 01, C2, 98, A2, DD, 6E, 0	1, 14, 00, 7B, FE, 7C, 20, D9, 3A, A4, 1812
720 DATA F1, F6, FF, C9, 21, EB, A4, CD, 90, A1, A	0, DD, 66, 01, 46, 23, 5E, 23, 56, EB, 2251	870 DATA A6, 3D, 32, A4, A6, 2A, A2, A6, 01, 14, 0
F, C9, 21, C9, A5, CD, 90, A1, AF, CD, 3550	800 DATA CD, 53, A1, D2, 93, A2, AF, CD, 00, A1, E	0, AF, ED, 42, 22, A2, A6, CD, F4, A0, 2447
730 DATA 00, A1, DD, 21, 00, 40, 12, CD, CE, A1, D	5, DD, E1, 01, 0A, 00, ED, 42, DD, 4E, 2802	880 DATA C9, 00, 00, 00, 00, 00, 00, 00, 00, 00, 0
D, 7E, 00, FE, FF, 28, 3F, DD, E5, E1, 2703	810 DATA 03, DD, 46, 04, ED, 43, A0, A6, EB, 2A, 9	0, 00, 00, 00, 00, 00, 00, 00, 00, 00, 00, 201
740 DATA 06, 0A, 7E, CD, 5A, BB, 23, 13, F9, 3E, 2	2, A6, AF, ED, 42, 22, 92, A6, EB, 36, 2630	
0, CD, 5A, BB, 7E, E6, 0F, C6, 24, CD, 2310	820 DATA FF, 7D, FE, 7C, 28, 5C, DD, 7E, 0A, FE, F	

WD Software

For the SINCLAIR QL:

JOSS £15 on mdv or 5 1/4" flp, £17 on 3 1/2" flp

Forget syntax errors and mistyped names in file commands! Just move a cursor and press SPACE. Cursor keys or joystick allows access to up to 8 microdrives and all the discs your interface will handle, with up to 150 files on each. Scroll & print directories, COPY, DELETE or PRINT any file, select TV or Monitor mode before LOAD/ing/RUN/ning a program. Use keyboard only to set date or label a medium. Easy to use with *Psion* or other software. No silly icons to learn — JOSS will tell you what it's doing! Mass copying/printing utilities and programmer's toolkit. Specify disc size, tracks and interface (CST, Cumana, PCML, MicroPeripherals) or microdrive only.

RefQL7 £11 on 2 mdvs or 1 3/2" flp, £9 on 5 1/4".

For use with *ARCHIVE 2*, contains 1300 useful references and a search/print program. Find programs, articles and reviews buried in the magazines on your shelf! Cheap updates of earlier edition.

Mdv extension cable (8") £5.50. Add ZX Microdrives to your QL Joystick Adaptor £4.99

For the QL, Spectrum (all), BBC & Electron:

WD Morse Tutor £4 cassette, £6 mdv or 5 1/4", £8 3 1/2".

Teach yourself to read Morse Code. From absolute beginning to 18 words/minute. Feedback on screen or printer. Random letters, numbers or mixed, 100 random sentences, many helpful features include phonetic speech via Currah Micro-Speech (Spectrum). Discs unsuitable for BBC B+

For the Sinclair Spectrum (48/128k):

Wordfinder 2 £8 cassette

16,000 word vocabulary, 3 to 10 letters long.

Wordfinder 3 £10 on mdv or 5 1/4" disc, £12 on 3 1/2".

19,000 word vocabulary, 3 to 12 letters long. Solves anagrams and missing-letter words. Very fast machine code. Update *Wordfinder 1* for £2.

Spectrum disc versions are Opus, TR (Beta) and SPD1.

We export hardware and third-party software. Ask for lists.

Payment

In advance, in STERLING or British bank branches, International Giro, Postal Order or ACCESS/MasterCard. Add £1 outside Europe for AIRMAIL.

from:

WDSoftware (PCW), Hilltop, St Mary, Jersey, C.I.

Tel 0534 81392

HARDWARE

	RRP	WAVE
Amstrad PCW 8256	£458.85	£409.00 (a)
Amstrad PCW 8512	£573.85	£513.00 (a)
Amstrad CPC 6128 green	£299.00	£267.00 (a)
Amstrad CPC 6128 colour	£399.00	£361.00 (a)
Amstrad CPC 464 green	£199.00	£178.00 (a)
Amstrad CPC 464 colour	£299.00	£267.00 (a)
DMP 2000 Printer inc. free cable	£159.00	£139.00 (a)
DD1 Disk Drive CPC 464	£159.95	£143.00 (b)
2nd 3" Drive ONLY - PCW	£182.85	£136.00 (b)
2nd 3" Drive + 256K Ram upgrade - PCW	£232.85	£162.00 (b)
Gemini Intergem Interface - PCW	£98.95	£69.00 (c)
PSD 3 Pace 5 1/2" Drive par Intergem	£143.75	£123.00 (b)
CPS 8256 Cent. - RS232 Interface - PCW	£68.94	£60.00 (c)
Brother HR15 Daisywheel printer PAR	£449.00	£399.00 (a)
Alphacom 32/Timex 20/40 printer-spec	£49.95	£18.95 (c)
BBC Master 128	£499.00	£430.00 (a)

SOFTWARE DATABASES

A. Tate Dbase II - PCW	£119.00	£87.00 (d)
Sage retrieve - 6128/PCW	£69.99	£44.00 (d)
Caxton condor 1 6128 twin/PCW	£99.99	£73.00 (d)
Camsoft: Cambase PCW	£49.95	£30.00 (c)
Camsoft: Nucleus - PCW	£99.99	£68.00 (d)
Composoft delta 6128 twin/PCW	£99.99	£70.00 (d)
Rat. Sol. At last 1 6128/PCW	£49.95	£33.00 (d)
Gemini datagem PCW	£39.95	£26.50 (d)
M.P.S. Kwikfile CPC	—	£10.00 (e)
C.F.2 3" Blank disks (box of 10)	£45.00	£35.00 (d)

SOFTWARE GAMES

Paperboy - Spec.	£7.95	£5.25 (e)
Trivial Pursuit - Spec./BBC/CBM/Ams.	£14.95	£10.30 (e)
Trivial Pursuit - Amstrad disc	£19.95	£13.75 (e)

All prices include VAT. Please add carriage indicated as follows: (a) £5.00 (b) £4.00 (c) £3.00 (d) £2.00 (e) £1.00 despatched by return of post

W.A.V.E.

Walney Audio Video & Electrical
53 Shearwater Crescent, Barrow-in-Furness,
Cumbria LA14 3JP. Telephone: 0229 44753
(mail order)

Please Wait

by John Chasey

This machine code utility for the C64 provides the facility to pause a Basic program and wait for a key to be pressed. Whilst paused, the screen border flashes until a key is pressed. Then, the original border colour will be restored and the program can continue.

```
80 FORX=49152TO49181
90 READDT
100 POKE X,DT
110 Y=Y+DT
120 NEXTX
130 IFY<>4402THENPRINT"DATA ERROR."
140 END
150 DATA 173,032,208,141,030,192,162
160 DATA 000,232,228,000,208,251,238
170 DATA 032,208,032,228,255,201,000
180 DATA 240,239,173,030,192,141,032
190 DATA 208,096
```

READY.

Screen Scroller

by Alexander Hildyard

Screen scroller for any Amstrad CPC enables a user defined chunk of the screen to be smoothly scrolled, one pixel at a time, for any distance.

On running the program the start line of the scroll, number of lines to be scrolled and width of the scrolling area are requested. This format can now be saved for later use.

The program now displays the address to *Call* to start the scroll.

```
35 addr=15000
40 FOR n=addr TO addr+44: READ a: POKE n
,a: NEXT
45 INPUT "Starting line of scroll (0-20)
";m
46 m=m*80+49152: y=INT(m/256): x=m-(256*
y)
47 POKE addr+1,z: POKE addr+2,y
50 INPUT "no. of lines to scroll ";a
60 POKE addr+4,a
70 INPUT "Width of scrolling area (79 ch
ars max.) ";b
80 POKE addr+11,b: POKE addr+16,b
90 INPUT "Save this format (Y/N) ";a$
100 a$=UPPER$(a$)
110 IF a$<>"N" THEN SAVE "scroll.lft",b,
addr,50
120 DATA 33,&80,&c2,6,8,197,229,6,8,197,
6,&4f,229,126,229,17
130 DATA &4f,0,25,119,225,35,126,43,119,
35,16,249,225,17,0,8
140 DATA 25,193,16,229,225,17,&50,0,25,1
93,16,217,201
150 PRINT "Now enter 'CALL ";addr;" to
scroll"
```

8056 Translator

by Ralph Lorenz

The Serial 8056 printer has been around for several months now, originally marketed solely as a QL compatible, but no screen dumps have yet appeared for it.

The following QL program dumps a *Mode 4* screen and correctly reproporions it to the size of the paper.

Note that black and red appear as white on the printout and green and white appear as black. The screen takes around 30 minutes to dump an entire screen.

```
100 BAUD 1200:OPEN #3,ser1:CLEAR
110 PRINT #3,CHR$(27);CHR$(49);
120 FOR r=0 TO 255 STEP 4
130 PRINT #3,CHR$(27);CHR$(75);CHR$(0);CHR$(2);
140 FOR c=0 TO 127 STEP 2
150 FOR p=7 TO 0 STEP -1
160 n=0
170 FOR b=6 TO 0 STEP -2
180 a=131072+128*(r+(b/2))+c
190 IF PEEK(a)&&(2^p) THEN n=n+(2^(7-b))+12^(6-b)
200 NEXT b
210 PRINT #3,CHR$(n);
220 NEXT p
230 NEXT c
240 PRINT #3
250 NEXT r
260 CLOSE #3
```

Evesham Micros

PRINTER OFFERS

Check out these offers on top quality dot matrix printers. All the models offered are substantially reduced from the normal high street prices. Prices are fully inclusive of VAT, delivery and lead to suit any computer with centronics parallel printer port, eg. Amstrad, B.B.C., Einstein, Atari ST, Oric, Dragon, Memotech or MSX. For the CBM 64/128 we supply a user port centronics cable. For Spectrum or QL owners an appropriate interface is supplied for an extra £20.00, for Atari models other than the ST an extra £30.00. Delivery is by insured receipted delivery and orders are despatched the next working day after receipt, provided we have stock.

Micro P. MP165

The best NLO of any printer in the price range? Many people think so. This particular printer has been very popular recently and should win even more friends at this price. Very highly featured with 165 cps draft speed and a switch selectable NLO mode at 70 cps. (Manufacturer's figures).

Standard features include friction and tractor feed, 2K buffer, Epson compatibility, quiet operation, and full graphics capability. This printer must offer the highest specification available for the price. Look at these unretouched, actual size print samples.

Superb near letter quality print and high draft speed make the MP165 an outstanding buy at this price. *Italics and good underlining* along with many other print modes confirms the **FACT**.

THIS MUST BE THE BEST PRINTER OFFER IN THE COUNTRY
ONLY £219.95

Price includes printer lead to suit your micro.
Or to suit Spectrum £239.95 including Centronics "E" interface

PANASONIC KX P1080

Now available at a really competitive price. This printer has a R.R.P. of £245 + VAT. Features are, 100cps; Friction and tractor feed; easy access "dip switches"; easy change long life ribbon and superb switch selectable NLO mode.

A sample of the impressive N.L.Q. from the Panasonic KX P1080 N.L.Q. available in Elite (12cpi) and italic modes.

Superb value from Evesham Micros
High quality from Panasonic
Two names you can trust

ONLY £199.95

Price includes Centronics lead to suit your micro.
Or to suit Spectrum with Kempton "E" Interface £219.95

STAR NL10

New high specification printer just released. All the usual features PLUS easy front panel selection of most modes, semi automatic single sheet feed AND plug in interface cartridges. Choose between standard centronics parallel, IBM, or Commodore. Ideal for Commodore owners who want the convenience of a CBM ready printer but may wish to change later, just buy a new interface cartridge for £38.00.

OUR PRICE: ONLY £269.00
(state which cartridge required)

AUTUMN SPECIALS

ATARI 1040ST mono	£799.00	ATARI 1040ST colour	£999.00
(these prices INCLUDE VAT)			
ATARI 520STM c/w SF354		Disk Drive	£449.00
FREE "THE PAWN" WITH ALL ATARI'S			
CBM 1526 printer	£149.95	5 1/4" 3M DISCS (packs of ten)	
CBM MCS 801 colour printer	£139.95	SS/DD £11.95	DS/DD £14.95
CBM 1541C Disk drive, latest model	£189.95	or in plastic library case	
CBM64C Compendium Pack inc. Mouse,	SS/DD £12.95	DS/DD	£15.95
Tape deck, Scrabble, Monopoly, Chess,		3" DISCS (suit Amstrad)	
Cuedo, Renaissance and typing tutor	£239.95	BOX OF TEN	£39.00
All offers subject to availability			

All prices include P&P and VAT. Send cheque, Postal Order or Credit Card No. Credit Card order accepted by phone. Callers welcome. Wide range of goods stocked. Trade enquiries welcome. European orders send price as advertised. Outside Europe £2.00 for airmail. Mail order to Evesham Shop please.

EVESHAM MICROS
BRIDGE STREET, EVESHAM,
WORCS., WR11 4RY.
Tel: 0386 41989

MICRO CENTRE
1756 PERSHORE ROAD,
COTTERIDGE, BIRMINGHAM.
Tel: 021-458 4564



TROWBRIDGE COMPUTER SHACK

ATARI ST

YOUR SPECIALIST DEALER

FOR

WEST OF ENGLAND

FULL RANGE OF

ST SOFTWARE,

PERIPHERALS,

IN FACT

EVERYTHING FOR THE

ST

8 Timbrell Street
Trowbridge, Wiltshire. Tel: (02214 67299)
PRESTEL MBX NUMBER 221467299

HARTLEPOOL COMPUTER SERVICES LTD.

BBC from £260 CBM 64 from £100 IBM from £600

WHY NOT SEND US A S.A.E. and we'll get a current price list off to you the same day? We obviously can't show much of our stock here due to lack of space.

If you have a modem then by dialling 0429 234346 you can log on to 'On-Line Systems' - our 24 hour Viewdata & Bulletin Board system. You can use any Baud rate from 75 to 9600, either Viewdata or scrolling Ascii. Send us a 6 digit password with your request for a catalogue & we will return a user No. You can still view the system without though. Just follow the prompts on the log-on page.

RAILWAY STATION, HARTLEPOOL, CLEVELAND TS24 7ED
Tel: (0429) 869988

One to One - 14315001 Telecom Gold 83: NTG 083
On-Line System 100000 Prestel MBX No. 429869988

MSX LATEST

King Size (50 game).....	£9.95
Confused?	£8.95
Eggy	£8.95
Panel Panic	£2.99
Moonrider.....	£2.99
Spacebusters.....	£2.99
Snakehit.....	£2.99
Ice	£2.99
Mazes Unlimited.....	£2.99
Robot Wars.....	£2.99
Footfolly.....	£1.99
Vestron.....	£1.99

LATE ARRIVALS

Frontline.....	£3.99
MSX Artist.....	£3.99
Dambusters.....	£9.95

FACULTY ENTERPRISES LTD
29 Rutland Court, Ponders End, Middlesex
Tel: 01-805 8054



With Kenn Garroch

The nature of Sin

D M Ford, of Newport, Gwent, writes:

Q I am learning Basic and would like to know what the Sin, Cos, and Tan functions really mean. I know that they are something to do with trigonometry and circles, but could you explain why and show some uses for them?

A Sins and cosines are to do with circles, in the following way. In the diagram, the line H (hypotenuse and radius or the circle) forms an angle b with the line A. The length of A is from the centre of the circle to where the line P meets it. The lines A and P meet at a right angle so the definitions of Sin, Cos, and Tan are:

$$\begin{aligned} \text{SIN}(b) &= P/H \\ \text{COS}(b) &= A/H \\ \text{TAN}(b) &= A/P \end{aligned}$$

As the angle b changes so that the line H is always the

radius of the circle, the lengths of the lines A and P change in length. From the above formulae, you can see that P is dependent on the Sin of b and A is dependent on the Cos of b.

If you then imagine the circle rolling along horizontally, a point (in the diagram the left most point on the circle) on the circle will describe a Sin curve as shown in the diagram. If it rolls downwards, the point describes a Cos curve.

Or, looking at it another way, as b varies, the length of P varies non-linearly between +1 and -1 (presuming the radius of the circle is one and the centre is taken as being at 0) and this non-linearity is defined by Sin. The same applies to A which is described by Cos.

The angle b varies through is 0 to 360 degrees or 0 to 2π radians (1 radian = $180/\pi$ degrees when $\pi=3.1415926$). Most computers work in radians so, Sin and Cos can be used by a computer to draw a circle:

```
10 FOR T=0 TO 2*3.1415926
STEP .1
20 PLOT SIN(T)*50+100,
COS(T)*50+100
30 NEXT T
```

Here, the position of each point is specified by Sin and Cos with T being the value of the angle. The result of Sin or Cos is always between +1 and -1 so unless the circle is going to be very small, the values need to be multiplied up by the value of the radius, in this case 50.

The absolute position of the centre of the circle is set

by adding a constant to the values of the horizontal and vertical points, in this case 100. You can change the shape of the circle to an ellipse by making the two radii different, the larger being the radius of the long axis, the smaller that of the short axis.

Tan(b) is Sin(b)/Cos(b) and varies between 0 and ∞ (infinity) as the angle b goes from 0 to 90 degrees (0 to $\pi/2$ radians). It is related to the tangent to the circle (hence the name) which is at right angles to the radius line (H).

You can see that it is 0 when b=0 since the length of P is zero. When b is 90 degrees, the value of TAN(b) is ∞ since the length of A is zero and anything divided by 0 is ∞ . It does not have that many uses in general programming unless you are specifically dealing with maths problems.

Monitor switching

A Henson of Dudley, Birmingham, writes:

Q I have an Amstrad CPC colour monitor and I would like to use it with my BBC micro. Is this possible?

A Yes, plug it into the RGB port - the connections are identical.

Garbage collection

Ian A King, of Greenford, in Middlesex, writes:

Your reply to Mr Brumpton of Clapham, London (Peek and Poke, August 28) is misleading and does not point the way to a solution to his problem, although your basic reasoning is in the right direction.

Garbage collection is indeed performed the first time within a program in which either *Openout* or *Openin* is

used. This is done in order to provide space for a buffer for file transfer. Unfortunately, the garbage collection is performed regardless of previous collections, whether forced by *Fre* or otherwise. Subsequent *Openouts* or *Openins* do not require this as the file transfer buffer is preserved once it has been set up.

The solution to the problem is to force a file transfer allocation as early as possible in the program, ie, before any string work, so that garbage collection is a minimal task. This is achieved by a line such as:

```
10 OPENOUT "DUMMMY":
MEMORY HIMEM-1:CLOSEOUT
```

The only restriction on this line is that it must be placed after any *Symbol After* commands.

The example program given in *Popular* would give a delay of only two seconds or so as all the *Name\$(i)* strings are identical and thus only one copy is stored, pointers for *Name\$(1)*, *Name\$(2)*, etc, all pointing to the one storage area, the same applies to *Addr1\$(i)*, *Addr2\$(i)*, etc. If line 30 were changed to read:

```
30 NAME$(T)="AAAA"+CHR$(30+T):
ADDR1$(T)="BBBBBB"+CHR$(30+T)
```

etc, making each string unique, the waiting time will be in the order of two minutes as experienced by Mr Brumpton and the need to overcome this, as above, becomes more of a requirement.

I cannot claim credit for this solution - it can be found on page 2.6 of the Amstrad DD-1 disc drive manual.

A Okay, I'm not perfect, my thanks to Mr King for providing and explaining the solution.

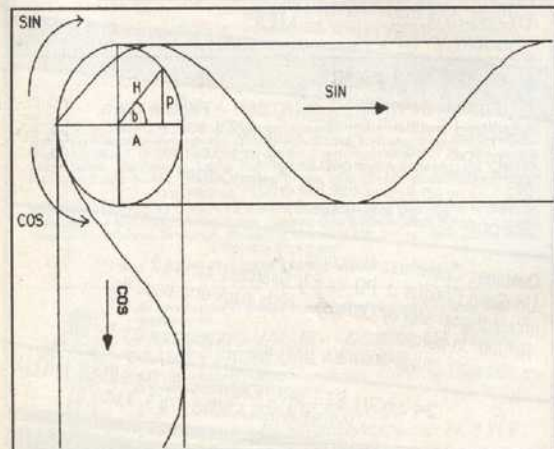

Is there anything about your computer you don't understand, and which everyone else seems to take for granted? Whatever your problem *Peek* it to Kenn Garroch and every week he will *Poke* back as many answers as he can. The address is *Peek & Poke, PCW, 12-13 Little Newport Street, London WC2R 3LD*

You'll be nuts to miss this show

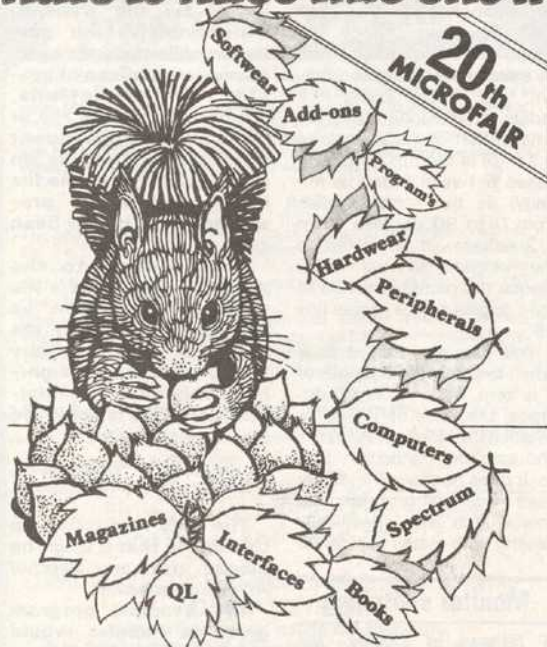

There's a bumper crop of goodies for the Spectrum and QL User at this year's Autumn Microfair in the Central Hall, Westminster, on Saturday 25th October 86.

See all the New Season's products including the New Spectrums, — plus the usual fantastic Microfair bargains, with big reductions on selected hardware and software.

The Show offers full support for all the SINCLAIR machines (and compatibles), with a huge range

of software, peripherals, books and magazines on sale — just about all you wanted for your computer under one roof!

Talk to the experts on the User Club stands or find special bargains at the bring-and-buy. You'll enjoy a great day out in a friendly atmosphere.

Send **NOW** for the reduced price advance tickets on the coupon below.

You'll be nuts to miss this show.

THE AUTUMN MICROFAIR

25th October 86'

At the Central Hall,
Westminster SW1

10am—6pm

Admission £2.00 (Adults)
£1.50 (Kids under 14)



SEND FOR REDUCED PRICE TICKETS TODAY

Send to Mike Johnston (Organiser), Dept ZX MICROFAIRS (PCW), 71 Park Lane, London N17 0HG

Please send me advance tickets
(Adults @ £1.50)

Please send me advance tickets
(Child under 14 @ £1.00)

Name:

Address:



Please include a stamped, self-addressed envelope and make cheques/POs payable to ZX Microfair

Exhibitors ring Mike or Moira on 01-801 9172 for details of stand availability.



Once Bytten

31 BOWNNESS ROAD
LONDON SE6 2DG

Phone Orders: 01-698 2911
(Callers by Appointment Only)



IT'S THE WAY WE SELL 'EM!
THAT MAKES ONCE BYTTEN DISC THE BEST BUY. TOP
QUALITY FLOPPIES FROM TOP FLIGHT MANUFACTURERS.
100% ERROR FREE — LIFETIME GUARANTEE AND NO HIDDEN
EXTRAS . . . WHAT YOU SEE IS WHAT YOU PAY.

SPECIAL OFFERS FOR AUTUMNAL EVENINGS IN FRONT OF YOUR MICRO!!

IN LIBRARY CASE WITH SLEEVES, LABELS, WRITE-PROTECTS AND HUB-RINGED:
10DISCS 5 BOXES (50 DISCS) 10 BOXES (100 DISCS)

5 1/4" SSDD	£8.95	£39.95	£75.00
5 1/4" DSDD	£9.95	£45.00	£85.00

IN LIBRARY CASE WITH LABELS:
10 DISCS 5 BOXES (50 DISCS)

3 1/2" SSDD	£18.95	£89.95
3 1/2" DSDD	£24.95	£117.50

AMSOFD discs £34.95

Bulk Unbranded Discs with sleeves
(Without boxes or labels, but same high quality discs)

5 1/4" SSDD 96tpi	25 £18.95	50 £24.95	100 £34.95	25 £18.95	50 £24.95	100 £34.95	
3 1/2" SSDD 135tpi	25 £39.95	50 £55.00	100 £85.00	3 1/2" DSDD 135tpi	25 £49.95	50 £65.00	100 £95.00

Please ring for quotations on larger quantities. Trade, Government and Company orders welcomed.
Quickshot II "The World's favourite joystick" £7.95 inc. P&P

DISC BOXES

5 1/4" 10 Capacity 1 + £1.50 10 + £1.25
3 1/2" 100 Capacity Locking 11 + £11.95
12 + £10.00

5 1/4" 10 Capacity 1 + £1.50 10 + £1.25
EXTRA ENVELOPES 5 1/4"
10 + 9p 50 + 8p 100 + 7p
500 + 6p 1000 + 6p

LABELS
5 1/4" Label Sets (for 10 discs)
inc. write-protects 1 + 35p 20 + 25p
3 1/2" Label Sets (for 10 discs)
1 + 25p 20 + 20p

IMPORTANT NOTE: Any order including 10 or more discs is POST FREE, otherwise please add £1.00.



Cheques or Postal Orders payable to AMTEN LIMITED please. Cash should only be sent by REGISTERED MAIL. You may pay by VISA or ACCESS card by mail or phone.

HOTLINE FOR PHONE ORDERS 01-698 2911 277010



ALPHACOM 32 PRINTERS

High quality thermal printer for all Spectrums at a give-away price only **£19.95** (p&p insurance £3.00)

COMPUTEC

MUSIC UK - (0902) 405100

HARDWARE

Prophet 5 to MIDI interface £100 inc VAT
Chroma to MIDI interface £299 inc VAT
DX Voice Vault
Decillionix The Box
DX7 ROMs from Skyslip and Rittor
Shadow GTM6 guitar to MIDI

SOFTWARE

Steinberg Syntech Passport C. Lab Joreth
Microvoz Treasoft DHCP Lemi MIDI soft
XRI Systems Icon Cheetah Roland Etc.
Roland JX8P Editor for the Commodore
Prophet 2000 Editor for the Commodore

Overseas Customers Welcome
UK Send Cheque or PO for £1, Overseas send £2
International Money Order, for facts pack and price list.
Refund on purchase
* The only music-software specialists in the country *

24 HIGH ST., BROCKMOOR, BRIERLEY HILL,
WEST MIDLANDS DY5 3JA



DOMARK

FOLLOWING OUR GREAT SUCCESS WITH

"SPLIT PERSONALITIES"
AND
"TRIVIAL PURSUIT"

WE HAVE LOTS OF NEW IDEAS AND WOULD LOVE TO HEAR SOME OF YOURS

IF YOU RUN A PROGRAMMING TEAM, WHO CAN PRODUCE A GAME FOR MOST (IF NOT ALL) OF THE HOME COMPUTER RANGE — THEN WE WOULD LIKE TO MEET YOU.

TOP RATES WILL BE PAID, SO . . . **RING RICHARD ON**

01-947 5622

AND LET'S SEE IF WE CAN DO BUSINESS TOGETHER!

FOOTBALL MANAGEMENT STRATEGY GAMES

from E & J SOFTWARE

48K SPECTRUMS

Three quality football games for serious enthusiasts. Each game uses the full available memory of your Spectrum or Spectrum + and is packed with genuine features.

PREMIER LEAGUE

OUR COMPREHENSIVE AND EXCITING LEAGUE GAME — FEATURES INCLUDE: Training, Team Selection, Substitutes, Half-Time Scores, Full Squad Details, Named Goal Scorers, Team Styles, Save Game, Financial Problems, Five Skill Levels, Transfer Market, Injuries, Continuing Seasons, Printer Option, PLUS MANY MORE!

EUROPEAN TROPHY

A SUPERB EUROPEAN COMPETITION STYLE GAME WITH THESE FEATURES: Home and Away Legs, Away Goals Count Double, Two Substitutes Allowed, Extra Time, Penalty Shoot-out (with sudden death), Match Injuries, Injury Time, Match Penalties, Five Skill Levels, Pre-match Reports, Team Selection, Named Goal Scorers, Save Game, Printer Option, PLUS MANY MORE!

***** SPECIAL FEATURE *****

Transfer your PREMIER LEAGUE winning side into EUROPEAN TROPHY.

Both these games can be played separately or as COMPANION GAMES.

***** Games £5.25 each *****

SPECIAL TWIN PRESENTATION PACK OF BOTH GAMES AVAILABLE AT ONLY £9.95

AND NOW! — WORLD CHAMPIONS

An exciting World Cup Football Management simulation taking you from the first warm-up friendlies through the qualifying stages, Tour matches and on to the finals. LOOK AT THESE FEATURES! Select Team from squad of 25, Pre-match Team News, Disciplinary Table, Full Results List, Match Suspensions, Change Player or Team Name, League Tables, Seven Skill Levels, Save Game, Printer Option, PLUS MANY MORE!

WORLD CHAMPIONS features a superb comprehensive text match simulation including the following: Match Timer, Named Goal Scorers, Goal Times, Corners, Free Kicks, Injuries, Bookings, Penalties, Sending Off, Injury Time, Extra Time, Penalty Shoot-out.

*** ALL THIS AT THE UNBEATABLE VALUE OF £6.95 ***



All games now in stock for immediate despatch — order your copies now!

FANTASTIC VALUE — ORDER ALL THREE GAMES FROM ONLY £15.95.

All prices include postage and packing (add £1.00 outside UK). Available by mail order only.

**E & J SOFTWARE, Room 5,
37 Westmoor Road, Enfield, Middx EN3 7LE**

**CHESS ON THE SPECTRUM
HAS NEVER BEEN THIS
REALISTIC**

CYRUS II



Playing is believing as far as this the ultimate chess playing sensation for the Sinclair Spectrum is concerned. The many features of this superior version means it will beat all existing Sinclair Spectrum chess programs published.

- Variable level performance
 - 1900 standard book opening
 - Set pieces
 - Problem solving
- plus many, many more unique features....

From beginner through to tournament playing expert Cyrus II is the only chess program that should interest you.
YOU DON'T BELIEVE US!!
Send us your old Spectrum chess program and we'll send you Cyrus II for the special offer price of £6.95. If you are not completely satisfied we'll refund your money along with your old chess game. **Mark I - Spectrum 48K Mark II - Spectrum 128K**

Please send me copies of Cyrus MKI MKII
I wish to take advantage of your special offer and enclose my old Spectrum chess program (delete if not applicable).

Please find enclosed a cheque/P.O. ** for the sum of £

Charge my Access/Visa the sum of £

Card No. Signature

Name Address

Postcode

*Tick as required ** Made payable to Alligata Software Ltd.
Please allow 7 days for delivery
Send to: Alligata Software Ltd., 1 Orange Street, Sheffield, S1 4DW.
**ALSO AVAILABLE... MARK II
3D CYRUS II FOR
SPECTRUM
128K**



Loony Bins, Drake Nets and other modern mysteries

David Wallin responds to questions of boardom and meets the real Adrian Mole

Most of my mail seems to be about new boards, and this week's batch is no exception.

Firstly, a letter from Dave Every, the Sysop of Drake Net. Drake Net is a Micron board and Dave says that some people are trying to log on but are unable to. He has three ideas as to what may be wrong, namely:

1) They are using the wrong type of equipment. A micron board may *only* be accessed by a Spectrum, BBC or C64 with the *appropriate* modem.

2) They are using incorrect software. Micron software must be used, and is available on Prestel/Micronet on the following pages: Spectrum - Page *600613517#; BBC - Page *8106542#; C64 - Page *600617282.

The software is free to download, but if you're a Spectrum owner who does not have access to Prestel/Micronet then it can be bought for £1 (postage, tape etc) from Micron Tape, Dave Every, 5 Turnbill Gardens, Chaddlewood, Plympton, Plymouth PL7 3XF.

3) They are using the software/modem incorrectly. To use Micron software on the Spectrum, with a VTX5000 modem you should break into VTX5000 main menu (*Do not use option 7*); place modem in TX mode; type *New*; load Micron software; select option 0 - Log on; dial 0752 330176 (or the number of any micron board); wait to hear the carrier tone; go On-Line (Put the silver switch on the front of the modem down); hang up phone (phew!).

Dave also included a brief description of the format used by a micron board, which is very similar to that of a viewdata board.

Pages may be accessed by **page_ number#*, ie, *280#.

Page 90 is used to log off, ie *90# to log off.

Menus are available, and the number of the desired function is selected by pressing the relevant number.

Lastly the times for Drake Net have changed. It now runs Monday to Friday, 10pm till midnight on auto answer.

There is also another Micron board now on-line. The details of this one, called Safety Net, based in Scotland, are as follows: the sysop is Peter Holt, its hours are Monday to Wednesday, 8pm till 10pm, and the number is 041-778 3426.

The sysop also gave his Prestel mailbox, which is 417783426. One interesting thing about this board is that although it runs using Micron software on a Spectrum, it also runs on a QL! The board runs on a Spectrum and a QL linked together using a network facility. This should give the board some interesting features, so why not give it a try and see what it has to offer? Remember that it is micron, so all the points Dave Every made above apply to this board too.

Another board recently put on-line is the nicely named Loony Bin. This board is open 24 hours, and the number is 0709 546254. Speeds are 300/300 and 1200/75 (8N1).

The sysop's name is Adrian Mole. Yes, it *really* is. The board has an adventure section, with clues, although it is not an adventure orientated board; there are other sections, including music, a hitchhiker's guide (?) and hi-fi. There are also BBC downloads for what sysop calls 'proper' users. Why not communicate with Adrian Mole?

A new board in the Itec range is now on-line. This board is called Hitec - Hillingdon Information Technology Centre.

Hitec is the Middlesex training centre's viewdata system. It was created by and is maintained by YTS trainees and supervisors. The information on the Hitec ranges from local Hillingdon area information, through computer news, to information about Middlesex training centre itself. Other features are jokes pages, quizzes, a gallery, games reviews, articles on local history, a list of local organisations, and machine specific databases (Amstrad, Sinclair, Acorn, Atari and Commodore).

Hitec has mailbox facility to leave messages to the sysops. Hitec is a viewdata system, so the speed is 1200/75 and the protocol seven bits, even parity and one stop bit. It runs on a BBC B, with twin 80-track double sided disc drives, and uses Communitel software.

The board is on-line 24 hours a day, 365 days a year. It will, however, be off-line for up to one hour each day for mailbox collection, etc. The time should be well under one hour as it is basically for maintenance of the board, and done daily this should not involve much work.

The system allows advertising at the cost of £1.50 per frame per month for businesses and free at present for private ads. There is a discount for keeping the advert in for a long time and a fee may arise for private ads in the future. Remaining details include the system operator (David Hook), the design coordinator (Nick Lewis (Max)) and his Prestel Mailbox: 08953 1726), the frame manager (Terry Naughton), and of course, the phone number: Uxbridge (0895) 59842. As with other Itecs, the board is free to use.

Next a request for help from Tony Surridge. His problem is that he has a Tatung Einstein, WS2000 modem, Tatung TP-100 printer and Kuma software and can't seem to auto-dial with his modem. The Einstein is a good machine but for various reasons there is not a vast amount of software available for it. But it does run CP/M, which means that there should be a fair amount of terminal software available (it may need installing though!) and one piece may well suit the needs of the Einstein.

It may be worth trying to get UKM7, which was explained in an earlier article. Otherwise, Tony, I think you're right, you may be best to change your equipment, but if you do this then you need only change the modem. If you were to change to an intelligent modem, say a WS4000, then all your auto dial, baud rate selection problems will be overcome.

You could also try a log on to PUBB, which is the only BB I know of which runs on an Einstein, and the sysop may well be able to help you out. The number of PUBB is 0594 52287, 1200/75 and 300/300 baud; hours 6pm to 8am.

Tony also wanted to know about BBs with an SF section or Sig. I don't know of any off-hand, but I'm sure that there must be some. If anyone knows of one then let Tony know. If you leave him a message on Cyberzone BB (01-638 2034, 300 baud, 24 hours) he should see it there.

Lastly, Tony points out that many boards seem unfriendly to the new user. They have large menus to be memorised, with up to 30 options. This is, of course, true, but I'm afraid it's a fact of life in communicating. A good board must have a lot of features and so must have large menus.

Win your share in our £2,000 giveaway

Here it is – the moment you've all been waiting for. The culmination of our great Movie Quiz. Ah, the nervous licking of lips, the sweaty palms, the slight trembling of fingers.

Here's the entry form and your chance to win a share of the sixty-five great prizes. Remember, the first five correct entries out of the hat each win a Spectrum Plus-Two. The next 10 correct

entries will win Star STX-80 printers, and there are fifty Magnum joysticks from Mastertronic as runners-up prizes.

Over the last four weeks we've printed eight stills from classic science fiction movies. Because some of you missed a week (we've told you before to place an order with your newsagent), we've decided to be remarkably generous and have printed them all again here.

All you have to do is identify the eight movies from the accompanying list (yes, there are a couple of red herrings), fill in the entry form, and send it to the address shown before Friday, November 7. Just like that. No catches, no underhand tricks.

Winners will be announced in *Popular Computing Weekly* issue dated November 20-26. What are you waiting for?

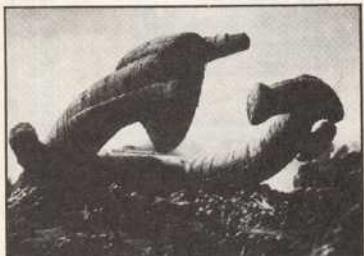

Photo No 1



Photo No 2



Photo No 3

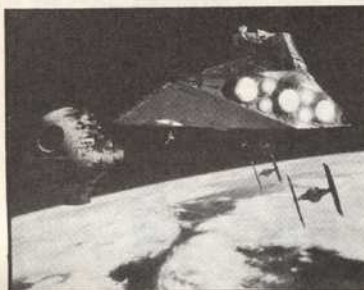

Photo No 4



Photo No 5



Photo No 6



Photo No 7

2010
 Alien
 Star Trek II
 The Last Starfighter
 Star Trek III
 Blade Runner
 Dark Crystal

Logan's Run
 The Empire Strikes
 Back
 Escape from New
 York
 Return of the Jedi
 Emmanuelle Meets
 the Martians

Send the entry form below to: *The Movie Quiz, Popular Computing Weekly, 12-13 Little Newport Street, London WC2H 7PP.*

Only one entry per person. No correspondence will be entered into, and the Editor's decision in all aspects of the competition is final.



Photo No 8

I think the eight movies are:

1.....	2.....
3.....	4.....
5.....	6.....
7.....	8.....

Name Address

..... Telephone

Computer currently owned

The micro's always musical on the other side of the pond

Mark Jenkins turns Stateside to let you know what's borne in the USA

In the recent Music Supplement we looked at some of the micro packages becoming available in the States, although some of them may not reach these shores. We concentrated on the Commodore 64 simply because it has established a huge user base in the US, and so continues to be popular for musical applications.

But it's not just the Commodore micros which attract Stateside attention; after a long thinking period the Atari 520ST and 1040ST have become popular with software houses, and offer the obvious musical advantage of built-in MIDI In, Out and Thru (the Thru function is wired to the spare two pins of the Out socket, in an imaginative cost-saving exercise which could be slightly confusing).

Apples are also popular in the US, and while the Apple II has now been discontinued, its successor the IIGS will run most II+/IIe/IIc software at three times the normal speed and sells for £995. It uses a 16-bit 65C816 processor, has Apple II compatible expansion slots, and has a built-in Ensoniq Mirage synthesiser.

Well, that's a bit of an exaggeration. What the Apple does have is a Q-chip, the heart of Ensoniq's Mirage sampler, ESQ-1 digital synthesiser and DSP-1 Sampled Piano. The Q-chip offers 32 oscillators, of which 30 are available on the new Apple to create 15 dual oscillator voices. There's a built-in Analog-to-Digital converter for sound sampling, so all you need is appropriate software.

Several US companies are already rumoured to be working on such software, which may well make life difficult for companies who make a living by adding sampling facilities to 16-bit computers such as the Atari (the Hybrid Sarts ADAP sampler would appear to be at risk, for instance). But it'll be interesting to get hold of the new Apple when it's available over here and compare it to an Ensoniq Mirage or similar sampling keyboard.

Apple's Macintosh is also popular in the US, although it works out quite expensive over here when you consider the cost of adding a Southworth or passport MIDI interface to run packages such as Southworth's Total Music, which has the unusual distinction of being able to record four MIDI inputs

"On the Atari 520ST you'll be able to obtain many Hybrid Arts packages over here very soon. DX-Droid is interesting - it creates new sounds for jaded programmers who don't want to specify more than 3 or 4 parameters"

simultaneously. This means that your whole band can play together and have the data recorded via MIDI for later editing.

On the Atari 520ST you'll be able to obtain many Hybrid Arts packages over here very soon. DX-Droid is interesting - it creates new sounds for the Yamaha DX7 synth for jaded programmers who don't want to have to specify more than three or four of the 147 parameters which go to make up each sound. Also from Hybrid comes the CZ-Droid, which does the same job for the Casio synths, and various composer packages for the 520/1040 and also for the cheaper 130XE.



The new Apple



Dr T also has several Atari packages, including a Casio CZPatch Editor/Librarian for the 520/1040 and a keyboard Controlled Sequencer coming up (this one only runs on the Commodore C128 at present). Dr T, 66 Louise Road, Chestnut Hill, MA 02167. Tel: 0101 617 244 6954.

Virtual Sounds has what seems like an interesting new package - Soft Synth, which generates synthesiser sounds in software on an Atari 520 or Macintosh and downloads them to a sampling keyboard such as the Mirage or Prophet 2000. Both keyboards could do with a little help on the synthesising side (although they're great for sampling) so Soft Synth could be a godsend.

Virtual Sounds, 557 Tremont, Suite 11, Boston MA 02118 USA. Tel: 0101 617 353 1815.

Opcodes, Mark of the Unicorn and many other US companies are manufacturing excellent compositional packages for the Apple Macintosh and IBM PC, both of which are a little outside our price bracket for current discussion. Many companies have developed a package for one micro - perhaps the Atari 520 - and claim to have the C128 or other version on the way, but, of course, it's difficult to find out when this is likely to happen.

A couple of companies over here do seem to be getting US products over - they are Rod Argent's Keyboards (mainly for Apple Macintosh and more upmarket stuff) and Syndromic Music (for Hybrid Arts and a few other imports). A London store called Take Note also has a wide range of computer packages on constant demo, and we'll check them out shortly.

Rod Argent's Keyboards, 20 Denmark Street, London WC2. Tel: 01-379 6690.

Syndromic Music, 24/26 Avenue Mews, London N10. Tel: 01-444 9126. Take Note. Tel: 01-485 2988.

If you have any queries or tips for this column, please write to Mark Jenkins at *Popular Computing Weekly*, 12-13 Little Newport Street, London WC2H 7PP. Mark would also welcome examples of your own music on audio or program tape, or disc.

CLASSIFIED

Semi-display — £7 per single cc (+ VAT)
Lineage — 30p per word (+ VAT)

CALL RODNEY WOODLEY on 01-437 4343 FOR SEMI/DISPLAY ADVERTISING

SOFTWARE

NEW FROM KBS-INTERACTIVE SOFTWARE

'ENGINE DOCTOR' — FOR EVERYONE

- RALLYING
- MOTOR RACING
- MOTOR CYCLING
- DIY MECHANICS
- THE PERFECT PRESENT

'ENGINE DOCTOR' — THE EXPERT

- DISMANTLE/REBUILD ANY FOUR-STROKE ENGINE
- STEP-BY-STEP SCREEN AND PRINTER TIPS
- BRIDGES THE MAINTENANCE MANUAL GAP
- PRINTS OUT ENGINE CHECK LIST
- PRINTS 'SHOPPING LIST' OF SPARES NEEDED

'ENGINE DOCTOR' — FOR MOST HOME MICROS

- GOOF-PROOF
- JARGON FREE
- IN SCHOOLS
- IN COLLEGES
- INVALUABLE

**All this for just
£49 inclusive**

If those aren't good enough reasons for buying 'Engine Doctor' for yourself (or as a present) . . . here is another!

For every 'Engine Doctor' order enclosing a KBS corner tab we will deliver a bouquet of flowers to anyone in mainland UK!

**GO ON . . . BE A
BIG SOFTIE!**

ORDER CHECK LIST

- ORDER ADDRESS
- FLOWERS ADDRESS
- USER FORMAT
- CHEQUE/P.O.

KBS-INTERACTIVE SOFTWARE

**FREEPOST,
NEWCASTLE HOUSE,
HIGH SPEN, NE39 2BL. Tel: 0207 543053**

KBS

ATARI games and UTL's for sale on tape or disk. Blank 5 $\frac{1}{4}$ " and 3 $\frac{1}{2}$ "", super prices. Also disc drive Enhance-mants "Happy" etc. Send S.A.E. lists. Stocksoft (Dept PC), 15 Woodbrooke Road, Birmingham B30 1UE.

PCW8256, Hisoft C, The Knife, Basic, Wordstar, Fairlight, CPM software etc, books £350. Phone David evenings, Birkenhead (051) 653 7712.

TORCH Z-80 disc pack 64K upgrade unit for BBC 'B' with twin 80T disc drives and BBC basic software for word processing, spreadsheet, data filing and business game. £350 o.n.o. Tel: 0244 26244 after 5pm.

KDS 104 modem, Amstrad 464, 6128 compat. New, unused because BT too attentive. Half price £76.50. Call Alan 088 388 2140.

ELECTRON with Plus 1 and Plus 3 expansion units, also word and word-sheet cassettes and green screen monitor, £275 o.n.o. Tel: 0244 26244 after 5pm.

APPLY for a computer Penpal. Please send a stamp for your application form to PS, 64 Cloverdale Crescent, Lisburn BT27 4LN, N. Ireland.

AMSTRAD CPC6128 with colour monitor, ROM board, RS232 interface, Protex, Commstar, Utopia (ROMs), Amstrad cassette recorder, joystick, software on disk including Elite and HHGTG. £350. Tel: 01-366 1706 after 7pm.

COMPUTER SWAP

Computer Swap entries are limited to 30 words. All entries cost £2.50. Please enclose a cheque or postal order or give Access or Barclaycard No in the box provided. Only text appearing in the grid will be printed. Send the form to: Computer Swap, Popular Computing Weekly, 12-13 Little Newport Street, London WC2H 7PP.

PLEASE NOTE All software offered through computer swap must be in original condition and for private sale only. No advertisements for lists of software will be accepted.

It cannot be swapped.
Warning: It is illegal to advertise pirated software.

COMPUTER SWAP

Please write your copy in capital letters on the lines below.

Name

Address

Telephone

Please charge my Visa/Access card no:

--	--	--	--	--	--	--	--	--	--	--	--	--	--	--	--	--	--	--	--

SUMMER PRICES HELD UNTIL OCT. 31st

AMSTRAD PCW8256/8512

Hardware		
256K RAM expansion quality tested components only.....		£25.00
Quality soft PVC Dust Cover Set only.....		£7.98
Printer ribbon.....	£5.60	2 Ribbons..... £10.95
2nd Disk drive.....	£145.25	HARD DISK. PHONE FOR DETAILS
CF2 Disks..... each £3.90	CF2 Disks box of 10..... £36.25	RS232/Centronics..... £56.95

Software		
Powerful	dBASE 11.....	£99.95
Versatile	DELTA.....	£91.00
Comprehensive	CAMBASE 2.....	£40.44

PLEASE PHONE FOR ADVICE ON THE RIGHT DATABASE FOR YOU

MAP Integrated Accounts.....	£125.50	CAMSOFI Integrated System.....	£136.45
Cracker 2.....	£42.88	Scratchpad Plus.....	£58.25
Pocket Wordstar.....	£42.20	Newword 2 & Word +.....	£60.38
Prospell.....	£24.99	Typing Tutors: Touch 'N' Go & IANKEY.....	£21.80
Brainstorm.....	£44.95	Smartkey.....	£44.95
DR CBASIC, DR PASCAL, DR DRAW, DR GRAPH.....		CHIT CHAT Combo.....	£87.99
		3D Clock Chess.....	£12.94

Quantity discounts available with 2 or more software packages

SINCLAIR QL

Super Q Board 512K NOW WITH THE EXCELLENT TOOLKIT 2.....		£239.00
Super Q Board 512K with dual 3 1/2" NEC Drives.....		£444.00
512K Expanderam.....	10 x 3 1/2" DS/DD disks.....	£25.00
	Serial cable.....	£6.75

NEW ITEMS FOR PCW

Music & Sound Generator.....	£34.99	Joystick Interface.....	£12.49
Electric Studio Light Pen.....	£69.99	Printer Extension.....	£11.95

We now stock quality software and hardware for the BBC and IBM PC. Send S.A.E. for details

Prices include VAT & POSTAGE PHONE FOR FURTHER DETAILS

All products are offered subject to availability

PERIPHERY

117 GAINSBOROUGH AVENUE, OLDHAM OL8 1AJ.

TELEPHONE: 061-626 5802

(36)

CHRISTMAS SPECIAL OFFER

PRICES INCLUDE VAT, P & P

SPECTRUM 128+2 GIFTPACK.....	£145.00
SPECTRUM 128+2.....	£135.00
AMSTRAD CPC6128 (colour).....	£360.00
AMSTRAD PCW8512.....	£520.00
AMSTRAD PCW8256.....	£420.00

ALL AMSTRAD ACCESSORIES AVAILABLE

MAIL ORDER CUSTOMERS PLEASE MAKE CHEQUE PAYABLE TO:

NEWCROWN COMPUTERS LTD

98-100 HIGHTOWN ROAD,
LUTON, BEDS LU2 0DQ (U.K.)

TEL: 0582 455684

REPAIR FOR FAST RELIABLE SERVICE

SPECTRUM £16.00
(INC. PART, VAT, P & P)

WE ALSO REPAIR COMMODORE, ORIC, VIC 20, BBC, AMSTRAD, ALL OTHER PRINTERS, INTERFACES AND DISC DRIVES WITH 3 MONTHS' WARRANTY ON REPAIR. SEND COMPUTERS WITH DETAILS OF FAULT AND A CHEQUE

SOME FABRIC RIBBON RE-INKING PRICES

Printer	Price £	Printer	Price £
Amstrad DMF1 & 2000	2.00	Amstrad PCW8256	1.90
Brother M1000	1.35	Canon 1090	1.90
Commodore 4023	1.75	Epson FX80	2.05
Epson LX80	1.90	Kangaroo K9110	1.90
Sekissha EP505	2.05	Shimada 4023	1.75
Silver Reed X444	1.95	South Canon 0200	2.15

If your exact fabric printer ribbon is not on this list, send it with £2.00 and we'll re-ink it and quote future prices.

ALADDINK, (Dept. CP), 4 Hurker Crescent, Eymouth, Barwickshire TD14 5AP (269)

SPECTRUM 48K software for sale. 45 games in total. Worth £310, will sell for £99. Games like Ace, TT Racer. Also Kempston interface + joystick £11. Tel: David on Rickmansworth 721255.

CBM 64, CN2, disc drive, monitor, including £1800 of software, much disc based, many high quality American games, valued at £2500, plus joystick etc. Great value £900. Tel: 0767 317885 after 6pm.

BLANK CASSETTES

WITH LIBRARY CASES

	C10	C15	C20	C30
10	3.80	4.00	4.15	4.50
20	7.00	7.20	7.40	8.20
50	15.00	15.20	15.90	17.50
100	27.00	28.00	29.00	33.00

Fully inclusive (COD 65p extra)
Superior Tapes. Don't Settle for Less!

DISKS

10 5 1/4 DS/DD £8
inc plastic case
10 3 1/4 SS/DD £17

MEMOTECH COMPUTERS AND ACCESSORIES

MTX 512 COMPUTER.....	£75.00
DMX 80 PRINTER.....	£150.00
RB232.....	£35.00
PASCAL ROM.....	£36.00
SPECTATOR ROM.....	£36.00
1 mb. DISK DRIVE & INTERFACE.....	£150.00
1 mb. DISK DRIVE & INTERFACE.....	£210.00

All the above prices are fully inclusive. We stock the entire Memotech Range. Orders/Enquiries to:

UK HOME COMPUTERS
25 CROFTS AVENUE
WILTS. SN2 1HN
24-hr Phone Service 0793 695034. 31PL27

AMSTRAD PCW 8256 plus Super Calc 2, New Word, Delta and Card Box software. Immaculate condition. Cost £820 in May 1986 - will sell for £550 o.n.o. Tel: Colchester 575009.

COMPUTER HIRE

TO HIRE A COMPUTER AND/OR PERIPHERALS BY THE WEEK OR MONTH RING 01-607 0157 or 01-997 6457 WE SPECIALISE IN BBC AND ALSO HAVE A RANGE OF AMSTRAD COMPUTERS FOR HIRE

COMPUTER HIRE SERVICES
294A CALEDONIAN ROAD
LONDON N1 1BA (3)

YOUR PERSONAL CENTRONICS' PRINTER

UNBEATABLE FROM £99
plus vat and £8 p+p

- DRAFT DOT MATRIX
- NEAR LETTER QUALITY
- SUBSCRIPT SUPERSCRIPIT
- CONDENSE EMPHASIZE
- 96 CHAR+48 EURO+16 MATHS
- EPSON/IBM GRAPHICS
- OPTIONAL TRACTOR

ROCK HALL LIME
128 STATION RD, GLENFIELD,
LEICESTER LE3 8BR
TEL: 0533 313531
TELEX: 341100.

ORDER NOW

DISCS

3" per 10 inc. ind. cases	
AMSOFT/PANASONIC CF2	£33.0
3 1/2" per 10 inc. box and labels	
MAXELL SSDD MF100	£22.43
MAXELL OSDD MF200	£22.63
VERBATIM SSDD MF350	£18.98
SONY SSDD D3440	£19.99
5 1/4" per 10 inc. box and labels	
ATHANA OSDD 40i A20	£9.86
MAXELL OSDD 40i M01D	£13.66
MAXELL OSDD 40i M02D	£18.54
MAXELL OSDD 80i M02D	£22.86
VERBATIM OSDD 40i S25	£12.80
VERBATIM OSDD 40i T50	£12.65
VERBATIM OSDD 40i S50	£15.87
VERBATIM OSDD 80i S57	£19.99
UNBRANDED OSDD 40i OC2D	£8.99

Prices inc. VAT and P&P (86)

RUGBY MICRO SPARES
30 OXFORD ST, RUGBY
CV21 3NF (0788) 71643
Callers welcome by App.

CASSETTE COPIES

50 C10's FOR ONLY £40 INC. P + P
FROM YOUR CASSETTE MASTER
IN REAL TIME PLEASE PACK
IN FOIL AND SEND CHEQUE TO—
SOUNDS GOOD
CLEAR CROFT, BOTTOM LAKE,
SEER GREEN, BUCKS HP9 2UH.
TEL: (04946) 5900

28PD3

FAST reliable service of DATA DUPLICATION for most computers. Competitive facilities include: master re-recording; blank disc/cassettes; blank or printed labels/labels. COMPETITIVE PRICE LIST item:



229A/395

AB COMPUTERS & ELECTRONICS

- * Low Cost Repairs
- * COMPUTERS: Atari, Commodore, Amstrad, BBC, QL, Spectrum, IBM & IBM compatibles.
- * PRINTERS: Juki, Epson, Canon, Citizen
- * Call Us On 01-568 7149
173 Thornbury Road, Oxtarley,
Isleworth, Middlesex TW7 4QG
Telex: 937400 ONECOM G
Ref: ABLTD (65)

The 1st choice

EXPRESS SPECTRUM, BBC
and COMMODORE REPAIRS!

SOFTWARE
RRP £39.00 FREE WITH
EVERY REPAIR

WHY PAY HIGH
'FIXED'
PRICES

Spectrum
repairs between
£9 and £20

BBC repairs
between
£14 and £45

Commodore
repairs between
£14 and £35

*Spectrums only

(We do not charge you for our fancy premises by charging high 'fixed' prices)

Reputations take time to build, we have been repairing ZX81's, Spectrums, QL's, Apples and BBC's professionally, for 2½ years - who is coming second?

In all U.K. with White-Wait repairs with INTERNATIONAL repair service!

to charge LOW PRICES for the smaller repairs (e.g. £9 for keyboard faults)

FOR LOW PRICES - "My computer blew recently, I took it to MANCOMP, who fixed it in 30 minutes and for less than £10! They are local, 'closed up', and bindingly efficient!" 4 HEATONS DIGEST.

FOR PROFESSIONALISM - "Of all the repair companies Sinclair User spoke to, MANCOMP seemed the MOST PROFESSIONAL when it came to advice and a helpful attitude" AUG 85.

FOR HONESTY - We let you watch your computer being repaired and if there is nothing wrong with it, we will tell you!!

FOR REPUTATION & HELPFULNESS - "I have come across a firm that will be more than willing to advise you as to how to remedy your problems. They are called MANCOMP and as well as repairing faulty computers, are also quite willing to discuss your problems with you and offer reasonably cheap and more importantly CORRECT CURE!" The Rogers POPULAR COMPUTING WEEKLY JAN 85.

FOR SPEED - "One firm at least can effect any necessary repairs over the counter in 45 minutes. Based in Manchester, MANCOMP can offer what is arguably the FASTEST turnaround in the business to personal callers" CRASH Magazine JUNE 1985.

THIS IS WHY Spectrum users from London, Cornwall, Scotland, Birmingham, Liverpool, Coventry, Leicester, Glasgow, I.O.M., etc. AUSTRALIA, AUSTRIA, BELGIUM, EGYPT, ETHIOPIA, GERMANY, HOLLAND, KUWAIT, NORWAY, PAKISTAN, PAPUA

NEW GUINEA, SAUDI ARABIA, SWEDEN, SWITZERLAND and ZIMBABWE - send their Spectrums to MANCOMP for repair!
24 HR. TURNAROUND NO-QUISLE GUARANTEE. NO HIDDEN COSTS.

Because we repair hundreds of computers every week, we are able to pass on our 'component buying discount' to YOU in lower prices - Z80A cpu £1.50, 4116 S0p, Upgrade fitted £18.95 - we bring down the prices for repairs and components! (We may refuse to revive computers suffering from attempted D.I.Y. repairs!)

Every parcel sent by Royal Mail Registered Post and insured for return! Journey! (For next day delivery include £1.50 extra.) (Secured by prior arrangement.) On-site maintenance for Apples, I.B.M.'s and most makes of printers also available. Guaranteed 4hr response! WHY DELAY - OUR ESTIMATES ARE FREE AND WITHOUT OBLIGATION. IF

YOU DO NOT LIKE OUR ESTIMATE, WE WILL RETURN THE COMPUTER AND REFUND THE POSTAGE INCURRED

MANCOMP LTD
(Dept PCW26)

Printworks Lane, Levenshulme,
Manchester M19 3JP
Phone 061-224 1888,
OR 061-224 9888.

OPEN MON - SAT 9am to 7pm



What we do today ...
others do tomorrow!

NOTE OUR PRICES AND WATCH OTHERS FOLLOW THE LEADER

SINCLAIR COMPUTER REPAIRS

- * SPECTRUM/PLUS COMPUTER REPAIRS £12.00 (Special Offer)
- * SPECTRUM (RUBBER KEYBOARD) REPAIR £8.50 (Special Offer)
- * SPECTRUM PLUS KEYBOARD REPAIR £12.00 (Special Offer)

SPECTRUM 16K/48K AND KEYBOARD REPAIR £20.00

SPECTRUM PLUS AND KEYBOARD REPAIR £23.00

INTERFACE ONE REPAIR £17.00

INTERFACE TWO REPAIR £17.00

MICRODRIVE REPAIR £17.00

SPECTRUM/PLUS POWER PACK £11.75 (with new replacement)

COMMODORE C64, C16/PLUS 4 VIC 20 Price on application

All prices are fully inclusive of labour, parts, postage and packing, and VAT. Send cheques or postal orders with computer only, unless power pack suspected.

CALLERS MOST WELCOME. OPEN 9.00 AM-6.00 PM MONDAY-FRIDAY (67)

I. T. WESTERN ELECTRONICS
UNIT F2A & F3, AVONSIDE ENTERPRISE PARK,
NEWBROUGHTON ROAD, MELKSHAM, WILTS. TEL: (0225) 705017

FAULTY SPECTRUM?

As you are probably aware from press reports Sinclair Computers no longer have a repair department.

Our computer repair workshop has been an OFFICIAL Sinclair Repair Depot for the past six years and we are pleased to announce that we will continue to do your out of guarantee repairs as in the past.

Send your faulty computer DIRECT

SPECTRUM	£18.75 inc parts
ZX81	£11.50 inc parts
16K RAM	£9.95 inc parts
MICRODRIVE	£15.95 inc parts
INTERFACE 1-11	£18.75 inc parts

CALL OR SEND WITH CHEQUE OR P.O.

T.V. SERVICES OF CAMBRIDGE LTD
FRENCH'S ROAD, CAMBRIDGE CB4 3NP
Tel: 0223 311371

28TV

SPECIAL OFFERS!

COMPUTERS	OUR PRICE	DISK DRIVES	OUR PRICE
Commodore 64 (used)	£99.99	Commodore 1551 suit C16 or Plus 4	£129.99
Commodore computer pack	£139.99	Cambridge 5 1/8 (BBC) used	£79.99
Amstrad CPC 6128	£249.99	Amstrad to suit CPC 464 or 6128	£129.99
Spectrum 128K	£99.99	Opus Discway Spectram	£59.99
PRINTERS		Opus single 5 1/4 (40)	£49.99
Amstrad DMP 2000	£144.99	Opus double 5 1/4 (40)	£99.99
	RRP	OUR PRICE	
Silver Reed D/wheel parallel	£275.00	£175.00	
Toshiba HXP 550 (graphics)	£225.00	£150.00	
Sekissha GP50 Spectrum	£59.99	£39.99	
Sekissha GP100A Miki parallel (one only)	£59.99	£39.99	
	RRP	OUR PRICE	
	£242.50	£182.50	
	£218.52	£159.99	

Computers & unwanted computer stock wanted for cash.
Now open 'Computer Repair Dept':
Faster & cheaper than the average (90 day warranty). (53)

THERSBY COMPUTERS
26-28 BOWSFIELD LANE, STOCKTON,
CLEVELAND TS18 3ER Tel: (0642) 604768

FOR SALE

QL - WORLD CHESS

Got Psion Chess? You have got the best programme. Now get the best games. All 24 games of the 1986 World Chess Championship on microdrive, with analysis.

Send £5 cheque/P.O. to:

P. CRADDOCK,
P.O. Box 88,
Twickenham TW2 5BR

CHARITIES. Software written to specification for Spectrum 48/+ or Amstrad 6128 computers. Very cheap. Contact Mike Roos, 22 Woodgrange Close, Kenton, Middx HA3 0XH.

STOP PLAYING GAMES

Use your computer to make money. Turn your hobby into a home-based income. Full and part time opportunities to cash in on this tremendous market. High earnings easily possible. Open to any amateur micro user and gamer. Write for free details.

Westlink Promotions
48 Great King Street
Edinburgh EH3 6GY (37)

COMPUTER WORKSHOP: Croydon YMCA. For beginners and all levels. Every Saturday. Tel: 01-651 4719 (for details).

CASPER THE INFORMATION BANK OFFERS YOU YOUR OWN PERSONAL ONLINE MAILBOX

80 COLUMN VIEWDATA SYSTEM AVAILABLE 24 HOURS A DAY FOR ONLY 1P PER MINUTE (£10 REGISTRATION FEE). FOR FURTHER INFORMATION CONTACT (01) 724 2100 OR JUST SEND YOUR NAME, ADDRESS & DATE OF BIRTH ALONG WITH A CHEQUE OR POSTAL ORDER FOR £11.50 (INC VAT) TO:-

CASPER, 23/25 PRAED STREET, LONDON W2 1NJ
NO OTHER CHARGES
300/300.1200/75.1200/1200.2400/2400.BAUD
7 BITS, EVEN PARITY, 1 STOP BIT ON LINE
PHONE (01) 724 8000 (65)

C16 + PLUS 4 OWNERS "20 USER" NEW

The only Magazine dedicated to Commodore C16 and Plus 4 Users is "20 USER" (C16 Plus 4 = 20), the official magazine of the C16 & Plus 4 Users Club. For too long now C16 and Plus 4 Users have been treated badly by the majority of the Computer Press, now with the advent of this club, C16/Plus 4 owners can get the most out of their computers.

"20 USER" is a monthly magazine which features all the latest C16 and Plus 4 news, reviews of the latest hardware and software, features, articles, program listings, readers' letters, competitions, special offers, advertisements from trade advertisers and much much more!

To receive a years' subscription to "20 USER" you have to join the C16 & Plus 4 Users Club, one years' membership costs just £10 and this entitles you to 12 issues of "20 USER", a membership card, free classified advertising and various club mailings throughout the year.

If you would like to subscribe to "20 USER" then please send Cheque/Postal Order International Money Order for £10 (UK Membership) or £15 (Foreign Membership) made payable to Micro Media to the following address.

C16 & PLUS 4 USER CLUB (20 USER),
C/O MICRO MEDIA,
42 MOUNT STEWART STREET,
CARLUKE,
LANARKSHIRE,
ML8 5EB

BBC OWNERS!

★ 25% OFF R.R.P. ★

TRUST ONLY £3.75 (disc), £5.95 (tape)

"SPEECH" ONLY £5.95 (disc), £7.45 (tape)

(Prices include of postage and packing)

(For return of post service, send cheque/P.O. to:

PILLAR BOX SOFTWARE

11 Ravenscroft Park,

Barnet, Herts EN5 4ND

Thrust and Speech are BBC B/B+/Master 128 compatible (53)

SCRABBLE £4.00. Tasword 2 £4.00. Micropursuit £2.50. Mastermind £2.50. Howe Hunter £2.50. For 48K Spectrum. Cheque or P.O. to E. Lewis, 36 Surrey Tower, Graveney Grove, London SE20 8UW.

SOFTWARE MAILBAG

QUIT	RRP	PRICE	COMMODORE	RRP	PRICE	AMSTRAD	RRP	PRICE
SPECTRUM 48K	7.95	5.70	Ghost and Goblins	9.95	6.80	Ghost and Goblins	9.95	6.80
Ghost and Goblins	7.95	5.70	Jack the Ninja	9.95	6.80	Chess Bares	9.95	6.80
Green Beret	7.95	5.70	Alleykat	9.95	6.80	Leaderboard	9.95	6.80
Paper Boy	7.95	5.70	Parasit	9.95	6.80	Jack the Nipper	9.95	6.80
Soft Personalities	7.95	5.70	Tau Cat	9.95	6.80	Knights Games	9.95	6.80
Jack the Nipper	7.95	5.70	Indybar	9.95	6.80	Highlander	9.95	6.80
Highlander	7.95	5.70	Leaderboard	9.95	6.80	Power Play	9.95	6.80
Ace	7.95	5.70	Jack the Nipper	9.95	6.80	Paper Boy	9.95	6.80
Zytrun	7.95	5.70						

All prices include free fast delivery and same day despatch when available. Cheques/P.O.s payable to SOFTWARE MAILBAG, Wharfedale, Daxham, Rufford LE15 8DZ (Overseas add £1 for P&P). (56)

LOOK!!!

—PRIVATE SALE—

ATARI 1040ST, plus 14" ATARI COLOUR MONITOR, plus 10MB HARD DISK, plus MOUSE, JOYSTICKS (2), SOFTWARE, etc. TOTAL WORTH OVER £1800. Quick sale needed £1000. TEL: (01) 386 8021 ANYTIME (almost new - boxed with manuals) **DON'T MISS THE BOAT!!** (56)

QL BACKUP SUITE V5.3

Corrupted masters? What are they? Byte for byte mdv duplicator is keys for all known mdv software in as little as 1 min. 10, inc. format. Detect invisible files, dates and file len. Swap strings in file. User relocatable EPR0M's from mdv. + "Fancy" window editor 100K+ £9.95 to **Steve Jones, ZITASOFT, 93 FOXBOURNE ROAD, LONDON SW17 6EN.** P.S. Advise update prior V5.0 (43)

AMSTRAD CPC. Planets positions, Eglyptic, Equatorial, Horizon co-ordinates, Printout, Star charts, £7. Webber, Cummal Fayle, Ballaterston, Ballaugh, Isle of Man.

"UNIQUE" drawing system for Spectrum 48K-plus programmers. Section 1 draws and calculates the area of any shape you choose. Section 2, a new way of drawing DATA. On cassette, just £1.50 post free. Y. T. Services Ltd, 54 Grand Avenue, Lancing, W. Sussex BN15 9PZ.

LOOK!!!

—PRIVATE SALE—
ATARI 1040ST, plus 14" ATARI COLOUR MONITOR, plus 10MB HARD DISC, plus MOUSE, JOYSTICKS (2), SOFTWARE, etc.

TOTAL WORTH OVER £1800
Quick sale needed £1000

Tel: 01-386 8021 anytime

Almost new - boxed with manuals!
DON'T MISS THE BOAT!!! (60)

GAP SOFTWARE

37 ST. JOHN'S TERRACE, LONDON E1 8B1 TEL: 01-552-5152

Designer - Version 2.7 of the graphics utility now available. Even easier to use, still points up to 52 screen lines. For business cards, letters, basic PCB design etc. Still only £9.95.

Character Designer - Now with 14 character sets. Still only £4.95.

Dumpy (Bradway Software) - Spreadsheet Designer - For Spectrum/Compaq, supports 13 popular interfaces. Many high/width variations. Still only £7.95.

OR BUY ALL THREE FOR £11.95!

All our cassette, microdrive, and tape compatible, and fully micro-driven: All a double to use Designer and Character Designer have an automatic hard-disk printer ribbon up.

RRD £4.25, M1000 £5.80. Ring for other prices. (300)

400/800 NOW

LOOK

XL/XE ST

ATARI OWNERS

Are you having difficulty finding suitable software, if so, then look no further. We have available for both sale and purchase one of the largest selections of both UK and American titles to choose from. Games and Utilities for all ages. Newware and software titles at discount prices and special offers regularly being offered. If you would like further information please send a card to:-

CHARWOOD PRODUCTS AND SERVICES
50A Warwick Avenue, Queens, London W9 3JH
Luton Luton LU1 5BZ
Tel: 0508 418264

SIGMASOFT character-set collection. 20 sets on tape only £4.00. 8 Pine Dale, Rainford, Merseyside WA11 8DP.

BROTHER EP/44 electronic typewriter with a 4000 character memory. Cost £240 May 1986. Will sell for £150 o.n.o. Tel: Colchester 575009.

POOLSMASER

GUARANTEED WINS • GUARANTEED WINS • GUARANTEED WINS

ASIRUS SOFTWARE presents the most up to date method for winning the POOLS ever devised. So much so that the company has decided to LIMIT the number of copies available to 3,000 which means it is **FIRST COME FIRST SERVED**. Whatever method you have used in the past, whether it be FORM, MAGIC NUMBERS, or UP DATING OF DATA you can now forget: **WHY**: because POOLSMASER eliminates all CHANCE, giving you a method which can be used ALL YEAR ROUND, with consistent returns of DIVIDENDS.

Developed over the past 2 years accuracy was our aim in finding a WINNING method, we did it, and called it POOLSMASER; Coupled with easy to follow on screen instructions, which enables the user to see how POOLSMASER operates, and why it works, and also showing how to STAKE and PERM your coupons to give MAXIMUM returns, making it a complete package.

To obtain a copy of POOLSMASER, and remember there are only 3,000 copies available, fill in the form below and together with a remittance of £30 send to:

ASIRUS SOFTWARE
54 Doverhouse Road, Putney,
London SW15 5AU

P.O./cheques payable to
ASIRUS SOFTWARE price
includes POST and PACKAGE

GUARANTEE

ASIRUS SOFTWARE guarantees that POOLSMASER will give you a winning dividend/dividends within 12 weeks or less. Should POOLSMASER not perform as stated above, then return the program for a £30 refund.

POOLSMASER is available for: ALL SPECTRUMS, ALL AMSTRAD CPCs, ALL BBCs, and COMMODORE 64/128 (all programs supplied on cassette)

I enclose cheque/P.O. for £.....

NAME.....

ADDRESS.....

Computer.....



Postcode.....

PLEASE ALLOW UP TO 28 DAYS FOR DELIVERY

POOLSMASER © 1986

There's a Dealer near you . . .

ESSEX

ESTUARY
PERSONAL COMPUTERS

318 CHARTWELL NORTH
VICTORIA CIRCUS SHOPPING CENTRE
SOUTHEND ON SEA
Tel: (0702) 614131

PL484

NOBLES

14-17 EASTERN
ESPLANADE
SOUTHEND-ON-SEA,
ESSEX
Tel: (0702) 63377/8

PL500

GLASGOW

THE COMPUTER DEPOT
205 BUCHANAN STREET
GLASGOW G1 2JZ
Tel: (041) 332 3944

PL706

MEGABYTE

12 ETRICK SQUARE
CUMBERNAULD
G7 1ND
0236 738398

(58)

INTERCHIP

3 MILLER STREET
GLASGOW
Tel: 041-248 6667
Dealers for Amstrad/Atari
and PC clones (290)

KENT

ANIROG COMPUTERS
29 West Hill
Dartford
Kent
Tel: (0322) 91649

PL404

MICROWAY COMPUTERS

39 HIGH STREET
RAINHAM, KENT
Tel: (0634) 376702

PL812

LEEDS

MICROPOWER

NORTHWOOD HOUSE
NORTH STREET
LEEDS LS7 2AA
Tel: (0532) 458800

PL483

LONDON

GALLERY SOFTWARE
1st FLOOR
THE ARNDAL CENT,
WANDSWORTH,
LONDON SW18
Tel: 01-870 4941

27PL29

GAMES WORLD

129 KING STREET
HAMMERSMITH
LONDON W6
Tel: 01-741 4467

PL516

LIVERPOOL

NABITCHO
COMPUTING

SPECIALISTS IN AMSTRAD
PCW8256 - PCW8512
SOFTWARE & HARDWARE

MEGABYTE INNOVATION CENTRE

131 MOUNT PLEASANT
LIVERPOOL L3 5TF
051-709 0123/708 8775

Software Design Service Available

26PL1

Microbyte

We talk business, not bits & bytes
NO. 1 ON MERSEYSIDE FOR
ATARI AND AMSTRAD
71 SEAVIEW ROAD, WALLASEY,
MERSEYSIDE L45 4QW
(051) 630 6933/638 1420
10 am - 6 pm

MAIL ORDER
SERVICE AVAILABLE



(310)



YORKSHIRE

YORK COMPUTER CENTRE
7 STONEGATE ARCADE
YORK
Tel: (0904) 641862

PL810

NORFOLK

THETFORD MICROS
SPECIALISTS -
COMPUTER REPAIRS
21 GUILDHALL STREET
THETFORD
NORFOLK
(0842) 61645

PL812A

HEREFORDSHIRE

HONEYSETT COMPUTERS
17 UNION STREET
HEREFORD HR1 2BT
Tel: (0432) 279404
ASK ABOUT
CLUNKER SALE

PL824

SURREY

ULTIMA
UNIT 28

WHITE LION WALK
GUILDFORD
(0483) 506939

26PLK04

SCOTLAND

FOR BARGAIN DISCS
CALL

GRABACOIN
9 LOW ROAD,
CASTLEHEAD,
PAISLEY,
SCOTLAND
PA2 6AQ
Tel: 041-889 0885

(64)

COMPSWAP

SPECTRUM PLUS, VTX5000, modern, joystick and interface, recorder, Beta Plus disc interface, Cumana drive, 50 discs in box, super working system worth £300 will consider reasonable offer. Tel: 01-529 0071.

EINSTEIN + green colour monitor, Spectrum emulator, speech synthesiser, software worth £350, including: Einstein basic, BBC basic, Logo Word-pro, database, spreadsheet, tutorial (basic), utilities, games, built-in disc drive, £375. Contact Peter 0952 582275.

ATARI 1040 STF + Hi-Res mono monitor and basic in Rom includes twenty + discs and original packing (cost £1150+), £900. Tel: Bill 01-572 2917. (Take QL Clone as part payment.)

WANTED: Disc interface/drive for Spectrum. Also cheap Spectrum (16 or 48K) and accessories, interface 1, microdrive, twelve cartridges with latest programs, £70 o.n.o. Haydn Barker. Tel: Rotherham 813042 (6pm). Betalpus interface or Opus preferred. **SHINVA CP80** lookalike but called Cosmos 80. Cracked cover, slight repair also, hence £60. Perfect working order. Centronics with lead, manual and paper. Will deliver in London. Tel: Ian 01-530 4333.

BBC B, 1-2 OS, basic 2, data recorder, games books and mags. V.g.c., £250. Tel: 0372 378897 after 6pm (Surrey).

ATARI 800XL, 1050 drive, XCI cassette including discs, software and 2 books. Worth over £250 - only 6 months old, have to sell - bought ST. Asking £180 o.n.o. Also Enterprise 64 - offers. Tel: 065 671 4304.

QL complete CST dual disc system. ICE Rom, joystick, parallel printer interface, manuals and many books, over £200 software. £450. Tel: Ash-tead (03722) 74410.

ATARI 1050 disk drive with Happy Enhancement, £200. Atari 810 disc drive with Happy Enhancement and unfitted upgrade, £150. Also Commodore colour monitor, £100. All reasonable offers considered. Tel: 01-577 6568.

ATARI 520 STM, plus Cumana 1MB disc drive, plus software, plus books, plus magazines, plus 12 ds/dd discs, plus monitor lead. All bought Sept 1986 and perfect. £540 quick sale. Tel: Jim 01-771 9115.

C64 disc drive, cassette, joystick, software, worth over £700, includes Simons basic, Logo Mercenary, PSI 5 cassette and disc based games, sell £450 o.n.o. Tel: 0222 752345 evenings.

WANTED CBM 64, C2N, disc drive, will pay approx. £200, can collect in the Manchester area. Tel: 061-790 0655.

OLIVETTI link jet printer, 2 months old, hardly used, in perfect condition. Must sell. £65 or nearest reasonable offer. Tel: 01-986 8378.

COMPLETE computer system. Spectrum 48K, lots of peripherals, books, software, ex-programmer's system. Also CBM 64 system. Cost in total £1400. All in v.g.c. Must sell quickly, only £450 o.n.o. Tel: 0656 712626 evenings only.

COMMODORE MPJ-801 printer for sale, hardly used, in original box with manual and paper, only £100. Tel: 0932 65107 or write: J.R., Corinth House, Broad Highway, Cobham, Surrey KT11 2RR.

CBM 64, disc drive, 1541 Express tape deck, printer, plotter, modem, 2 joysticks, dust covers, plus Super-base, Easy Script, Easy Spell, Quill, Elite and lots of discs. Tel: M. Hirst day 0274 308493 or 0274 573981 evenings. £400 o.n.o.

ACORN ELECTRON with twin disc drives plus one Rombox, Joysticks, Rom and tape s/ware, books and mags. All excellent condition, worth £1,050, yours for £600. Won't split. Tel: 0895 55497 (Martyn).

TI 99/4A MINI MEMORY £30. Logo 2 Editor Assembler £20, Assembler manual only £12. Number Matic, Mission Impossible, Voodoo Castle, Early Reading £2 each, new. 32 Glenshesk Park, Dumurry, Belfast BT17 9BA. Tel: 0232 623001.

New Releases

John Cook looks through this week's new arrivals

Amstrad CPCs

Program Prodigy Type Arcade Adventure **Micro** 464/664/6128 **Price** £9.99 464/664/6128 **Supplier** Electric Dreams, 31 Carlton Crescent, Southampton SO1 2EN.

Program Doomdark's Revenge Type Adventure/Strategy **Micro** 464/664/6128 **Price** £9.95 tape, £14.95 disc **Supplier** Beyond, 74 New Oxford Street, London W1.

Program Speed King Type Simulation **Micro** 464/664/6128 **Price** £1.99 **Supplier** Mastertronic, 8-10 Paul Street, London EC1.

When it was released on the Commodore 64 a couple of months ago, *Speed King* quickly became one of my favourite games.

Now out on the Amstrad, it's lost very little in the translation. It's still fast, addictive and packed with features.

There are ten international circuits to test all your skills from the flat-out Silverstone, to the treacherous turns of Daytona.

The graphics are only a little cruder than on the 64 - still colourful and very nicely animated.

There are quite a few more expensive race games around at the moment, but they offer very little more for the money.

Speed King must be the bargain of the year.



Program Formula One Simulator Type Simulation **Micro** 464 **Price** £1.99 **Supplier** Mastertronic, 8-10 Paul Street, London EC1.



Program The Eidolon Type Arcade Adventure **Micro** 464/664/6128 **Price** £9.99 tape, £14.99 disc **Supplier** Activision, 23 Pond Street, London NW3.

Program Street Hawk Type Arcade **Micro** 464/664/6128 **Price** £8.95 **Supplier** Ocean, 6 Central Street, Manchester M2 5NS.

Program Bactron Type Arcade **Micro** 464/664/6128 **Price** £9.99 tape, £14.99 disc **Supplier** Activision, 23 Pond Street, London NW3.

Program Space Shuttle Type Simulation **Micro** 464/664/6128 **Price** £9.99 tape, £14.99 disc **Supplier** Activision, 23 Pond Street, London NW3.

Space Shuttle has been around for quite a while - notably on the Commodore 64 where it made its appearance around two years ago. So, the Amstrad version has been a long time coming. How has the conversion stood up?

Graphically, the game is excellent with a colourful display consisting of an out-the-cockpit view, various control panels and mini-displays, and some excellent animation on satellite launches and the like.

I assume it's also very realistic. Which is to say, dull.

The whole point about fly-

Pick of the week

The Pawn Shop

Program The Pawn Type Graphic Adventure **Micro** CBM 64 **Price** £19.95 **Supplier** Rainbird, 74 New Oxford Street, London WC1.

The plot involves your quest to remove a silver arm-band, and the complex conspiracies into which you are unwittingly drawn.

Bob Stephenson's graphics are as charming and stunning as those on the ST/Amiga version, and to make up for the lack of pull-down scrolls there's an ingenious "camera" feature which can insert miniature versions of the current location picture at the top of the screen.

Forthcoming is a CBM 128 version on a single disc, which is faster and can display 80-column text. Both versions include the off-the-wall novella "A Tale of Kerovnia" which will introduce you to Gringo Baconburger, the Roobikyoub Dvarves, the whinging Princess and the ineffectual Prince Malcolm.

This is the adventure for people who hate adventures. At last transferred from the airy heights of the 68000 - QL, ST, Amiga - to a micro within the reach of ordinary mortals, *The Pawn* survives the transition not only well, but astonishingly well.

In many ways a straightforward text 'n' graphics adventure, *The Pawn* is transformed by an unusually powerful parser (text interpretation system) and a de-ranked sense of humour. None of your two-word commands and endless "I don't understand that" - the most complex English sentences can be interpreted and acted upon, and the computer will always come up with a sensible reply.

You tend to forget that this is just a computer game, when commands like "take the plant, plant it in the plant pot, then get all the garden tools except the hoe and rake and go north" are acted on without a qualm by the computer.

The game's humour is usually based on in-jokes - the Irrelevant Maze, the Unimplemented REM Statement - and should have both hardened adventurers and neophytes chuckling into their mead. For all that, this is a challenging adventure and sets new standards in parsers, graphics, and programming sophistication on the 64.

Take gold to software shop - buy game.

ing the space shuttle is to follow a flight plan to the last detail. So all you have to do is keep your flight path as near as possible to the pre-ordained version.

Landings are quite gripping, as you jockey to keep the machine on line, but even here the novelty soon pales.

Real shuttle flying is probably quite exciting, since - as we know - the stakes are the highest imaginable. When the only penalty for failure is to redo the launch sequence yet again, and the only reward for success is the pretty screen display, there's not a lot to commend it.

Make believe spaceships - as in *Elite* or *Mercenary* - or ordinary aircraft simulations are much more exciting.

Atari ST

Program Hacker II Type Ad-

venture **Micro** Atari STs **Price** £24.99 **Supplier** Activision, 23 Pond Street, London NW3.

Program Tass Times in Tontown Type Graphic adventure **Micro** Atari STs **Price** £24.99 **Supplier** Activision, 23 Pond Street, London NW3.

Program Shanghai Type Strategy **Micro** Atari STs **Price** £24.99 **Supplier** Activision, 23 Pond Street, London NW3.

Commodore

Program Black Hawk Type Arcade **Micro** C64 **Price** £1.99 **Supplier** Sparklers, Unit B11 Armstrong Mall, The Summit Centre, South-

wood, Farnborough, Hants GU14 0NP.

Program GBA Championship Basketball Type Simulation **Micro** Commodore 64/128 **Price** £9.99 tape, £14.99 disc **Supplier** Activision, 23 Pond Street, London NW3.

Sports simulations came into vogue about two years ago, and there's still no sign that they're about to go out of favour.

The latest is *Two-on-Two Basketball* from US company Gamestar, producers of the wonderful *On-Field Football*.

Distributed by Activision, *Basketball* is a tour-de-force with splendid animated graphics, excellent gameplay, and enough strategy to keep you interested.

You can name your own team, choose a second player



as your team-mate, allocate skills to dribbling, stealing, shooting and so on, and then compete in a league against a number of teams at different skill levels.

Great stuff.

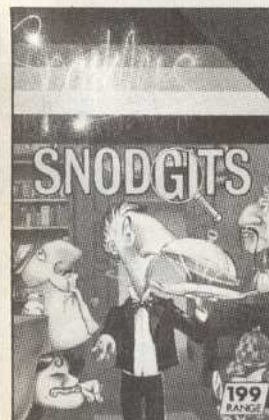

Program Hacker II Type Adventure **Micro** Commodore 64/128 **Price** £9.99 tape, £14.99 disc **Supplier** Activision, 23 Pond Street, London NW3.

Program Snodgits Type Arcade Adventure **Micro** Commodore 64 **Price** £1.99 **Supplier** Sparklers, Unit B11 Armstrong Mall, The Summit Centre, Southwood, Farnborough, Hants GU14 0NP.

Program The Rocky Horror Show Type Arcade Adventure **Micro** Commodore 128 (enhanced version) **Price** £9.99 tape, £14.95 disc **Supplier** CRL, 9 Kings yard, Carpenters Road, Stratford, London E15.

A special treat for Commodore 128 owners this week: an enhanced version of *The Rocky Horror Show*, one of CRL's greatest games.

It's an animated arcade adventure based on the cult movie, and the graphics are stunning. If you've been wondering what use all that extra memory was, here's a good answer.

Program Prodigy Type Arcade Adventure **Micro** C64/128 **Price** £9.99 tape, £14.99 disc **Supplier** Electric Dreams, 31 Carlton Crescent, Southampton SO1 2EN.

Program Sanxion Type Arcade **Micro** Commodore 64 **Price** £9.95 tape, £14.95 disc **Supplier** Thalamus, Front Office, First Floor, Advance Works, 44 Wallace Road, London N1 1PQ.

Program Assault Machine Type Arcade **Micro** Commodore 64/128 **Price** £9.95 tape, £12.95 disc **Supplier** Nexus, DSB House, 30 High Street, Beckenham BR3 1AY.

Program Tass Times in Tone-town Type Graphic Adventure **Micro** Commodore 64/128 **Price** £19.99 (disc) **Supplier** Activision, 23 Pond Street, London NW3.

Program Shanghai Type Strategy **Micro** Commodore 64/128 **Price** £14.99 (disc) **Supplier** Activision, 23 Pond Street, London NW3.

Program Street Hawk Type Arcade **Micro** Commodore 64/128 **Price** £8.95 **Supplier** Ocean, 6 Central Street, Manchester M2 5NS.

Commodore Amiga

Program Hacker II Type Adventure **Micro** Amiga **Price** £24.99 **Supplier** Activision, 23 Pond Street, London NW3.

Program Tass Times in Tone-town Type Graphic Adventure **Micro** Amiga **Price** £24.99 **Supplier** Activision, 23 Pond Street, London NW3.

Program Shanghai Type Strategy **Micro** Amiga **Price** £24.99 **Supplier** Activision, 23 Pond Street, London NW3.

Spectrum

Program Black Hawk Type Arcade **Micro** Spectrum 48K **Price** £1.99 **Supplier** Sparklers, Unit B11 Armstrong Mall, The Summit Centre, Southwood, Farnborough, Hants GU14 0NP.



Program Prodigy Type Arcade Adventure **Micro** Spectrum 48/128K **Price** £7.99 **Supplier** Electric Dreams, 31 Carlton Crescent, Southampton SO1 2EN.

Program Dragon's Lair Type Arcade **Micro** Spectrum 48/128K **Price** £7.95 **Supplier**

Software Projects, Bearbrand Complex, Allerton Road, Woolton, Liverpool, Merseyside L25 7SF.

Program Street Hawk Type Arcade **Micro** Spectrum 48/128K **Price** £7.95 **Supplier** Ocean, 6 Central Street, Manchester.

One of the longest-running sagas in the software business has been the 'coming soon' story of Ocean's *Street Hawk*. Well, it's here at last and sadly it must be said that it wasn't worth the wait.

You drive this motorbike, see. And the screen scrolls from top to bottom, while other vehicles drive from bottom to top.

Some of these vehicles are baddies which you should zap with your laser. If you kill civilians, the police come after you. If you hit anything, you lose damage points.

Every once in a while, you get a shift of scene to the outside of a liquor store (an off licence, to you and me).

This must be a big store because it takes about ten blokes to rob it. Their punishment for this villainous activity is disintegration with your laser. Then it's back on the bike for more car shooting.

Frankly, it's awful. The graphics are nice, but sooo slow. When you're supposed to be doing 120 mph, the screen crawls along. A gran-

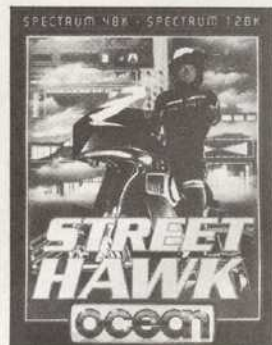

ny in an electric wheelchair would give *Street Hawk* a good run.

Superficially similar to *Spyhunter*, but nowhere near as good, *Street Hawk* should have been buried and forgotten.

QL/Brother explained

Further to the problems concerning connection between the Sinclair QL and the Brother EP44 printer (*Popular*, May 1, and Letters, July 31), I too have sweated

Baud Rate	1200
Bit Length	8
Parity	N
New Line Code	CR
Code (run program in all 3)	Y
ER	

blood trying to achieve the desired results.

The EP44 is supplied in many different character versions, not all of which are shown in the handbook and dependent on the country of purchase and this article may well be helpful to overseas readers.

Before selecting the final

	7-Bit & T/W Modes	8-Bit Mode
Driver Name	EP44	EP44
Port	ser1	ser1
Baud Rate	1200	1200
Parity	None	None
Lines/Page	59 (or to suit)	59 (or to suit)
Characters/Line	80	80
Continuous Forms	Yes	Yes
End of Line Code	CR	CR
Preamble Code	None	None
Postamble Code	None	None
Bold On	Def	Def
Bold Off	Def	Def
Underline On	ESC, E	Def
Underline Off	ESC, R	Def
Subscript On	ESC, U	None
Subscript Off	ESC, U	None
Superscript On	ESC, D	None
Superscript Off	ESC, D	None
Translate 1	£, 35 (if "£" avail.)	£, 156 (as desired)
Translate 2 to Translate 10	(as desired)	(as desired)

data code settings (7-bit, 8-bit or T/W) for the EP44 and the *Install.Bas* data for *Quill*, it is a good idea to switch the EP44 to terminal mode and

10 BAUD 1200
20 OPEN#8, ser1
30 FOR n=32 to 255
40 PRINT #8, chr\$(n)
50 NEXT n
60 CLOSE#8

then run the simple Program X, to establish the character set available in each data code setting. Compare with the handbook to find out which version of the EP44 you have (the 7-bit setting is probably best disregarded for the QL).

If all the characters required are printed in the T/W setting, then this is the best choice, being the only way to achieve sub- and superscript.

The best option, in my opinion, is to utilise the 8-bit mode, which gives you a plethora of different characters, although not the same set which is available when using the EP44 as a typewriter. These characters are broadly the same as those listed in the concepts section of the QL manual (table 3).

In 8-bit mode, of course, superscript and subscript are not available, but this is a minor disadvantage. The *Install.Bas* data for this mode is then acceptable in the form recommended by Barry Ashfield (May 1), but I am surprised he makes no use of a 'bold' function, which I find particularly useful.

The only essential translation in the *Install.Bas* routine is Barry Ashfield's Translate 1 to enable the £ sign to be printed normally. I would recommend that the *Install.Bas* data (table two) be used for the 8-bit mode setting, with

additional translations to suit individual needs.

Finally, in case of difficulties, I have always found the staff of Brother in Manchester (061-330 6531) to be very helpful, particularly Dave Stockley of Brother International.

Jim Bissett

Table 3 - character differences

Decimal	Keying	Chr (QL)	Chr (EP44)
96	£	£	
127	Shift ESC	©	none
128	Ctrl ESC	à	ù
129	Ctrl Shift 1	á	ú
130	Ctrl Shift 2	â	û
131	Ctrl Shift 3	ã	ü
132	Ctrl Shift 4	ä	ý
133	Ctrl Shift 5	å	ÿ
134	Ctrl Shift 7	ç	ä
135	Ctrl Shift 7	ç	ä
136	Ctrl Shift 9	ñ	è
137	Ctrl Shift 0	ñ	è
138	Ctrl Shift 8	ñ	è
139	Ctrl Shift -	¿	¿
140	Ctrl -	à	ù
141	Ctrl -	á	ú
142	Ctrl -	â	û
143	Ctrl -	ã	ü
144	Ctrl 0	ä	ý
145	Ctrl 1	å	ÿ
146	Ctrl 2	í	í
147	Ctrl 3	í	í
148	Ctrl 4	í	í
149	Ctrl 5	T	ó
150	Ctrl 6	ó	ó
151	Ctrl 7	ó	ó
152	Ctrl 8	ó	ó
153	Ctrl 9	ó	ó
154	Ctrl Shift:	ú	ú
155	Ctrl Shift:	ú	ú
156	Ctrl Shift:	ú	ú
157	Ctrl Shift:	ú	ú
158	Ctrl Shift:	ú	ú
159	Ctrl Shift /	í	í
160	Ctrl Shift 2	À	À
161	Ctrl Shift A	À	À
162	Ctrl Shift B	À	À
163	Ctrl Shift C	À	À
164	Ctrl Shift D	À	À
165	Ctrl Shift E	À	À
166	Ctrl Shift F	À	À
167	Ctrl Shift G	À	À
168	Ctrl Shift H	À	À
169	Ctrl Shift I	À	À
170	Ctrl Shift J	À	À
171	Ctrl Shift K	À	À
172	Ctrl Shift L	À	À
173	Ctrl Shift M	À	À
174	Ctrl Shift N	À	À
175	Ctrl Shift O	À	À
176-224	Various	Various	no
225	Alt Capslock	none	no
230	Shift Ctrl Lock	none	no
237	Ctrl F2	none	no
241	Ctrl F3	none	no
246	Shift F4	none	no
248	F5	none	no
253	Shift Tab	Back Tab	no

NEXT WEEK

Special Supplement The Commodore 64

Commodore's Connoisseur's Compendium - this year's package deal on the new 64C machine. Chris Jenkins takes his pack to pieces... disc drives: the 1541C compared to First-Line's independent Commodore 64 drive, the Enhancer 2000...

... Plus software galore: programming utilities - which will suit you best? Wigmore's *Artist 64* - how does it compare to current graphics programs? *Print Shop* from Precision - a document designer par excellence? *The Pawn* arrives on the 64 - has the standard been maintained?

Tune in next week for the answers.

Chess Board

More moves in *Popular* vs *Colossus* game, and Martin Bryant's monthly column. A must for chess fans.

Games

Feast your eyes on these reviews: *Deep Space* and *Arena* from *Psychonosis*; *Aliens* and *Dandy*.

Hackers

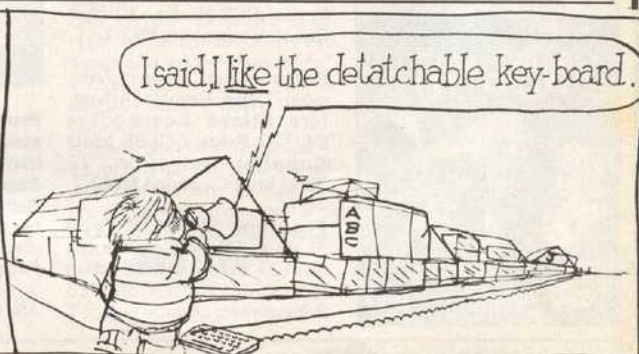

FROST BYTE

by

~~mikro~~
GEN

Spectrum Amstrad
Cassette
£8.95
Amstrad Disc
£13.95



Steinar

C64
 VERSION
 ZZAPI 64
**'FLIGHT
 SIMULATOR
 OF THE YEAR'**
 OUT NOW — £9.95
 SPECTRUM VERSION — £12.95
 (FULL 64K PLUS4 VERSION)
PLUS4 DISK VERSION
FREE POSTER WITH EVERY COPY



"AT LAST YOU CAN REALLY FLY!"

"I JUST COULDN'T BELIEVE HOW MUCH THERE WAS IN IT" ZZAPI 64
 "ACE IS ONE OF THE BEST SIMULATORS I HAVE EVER PLAYED" CCI
 "THERE ARE FLIGHT SIMULATORS AND THERE ARE FLIGHT
 SIMULATORS — AND THEN THERE'S ACE"
 COMPUTER AND VIDEO GAMES



CASCADE GAMES LTD,
 HARROGATE, HG1 5BG,
 ENGLAND
 TEL: (0423) 504663

Screen shots are taken from the C64 version

Available from all good software suppliers or direct from
 Cascade - 24 hour ordering service on (0423) 504663
 Versions available for: SPECTRUM, 88K,
 COMMODORE C64, VIC20, PLUS4
CASSETTE £9.95
DISK £12.95
 C64/128, Plus4 only