

NEW ZEALAND'S LEADING COMPUTER MAGAZINE

# BITS & BYTES

July 1986. \$2.25.

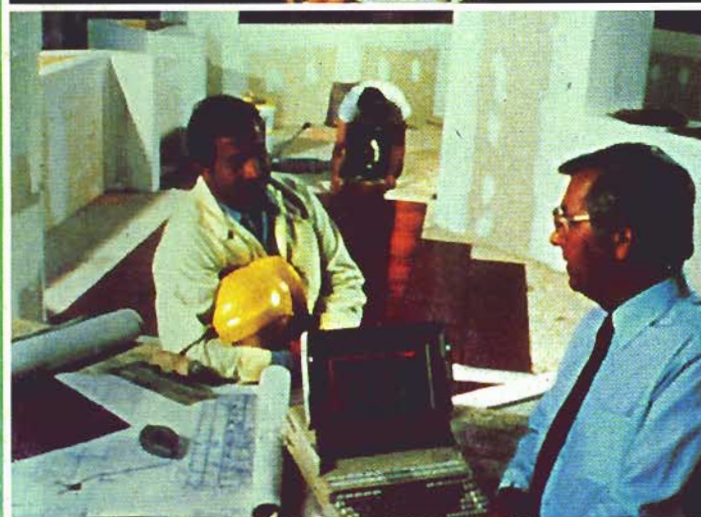

**REVIEWS :**

**Data General's DG2 lap-top.**

**Toshiba arrives with T1100.**

**Superscript for C64**

**Also featuring: Speech!**

**Bank-switching debate.**

**Soft-Tech: NZ software "gold".**

**UK Report – computer-video link.**

**Plus columns for Atari, Amstrad, Apple, BBC, Commodore, Sega, Spectravideo, Spectrum, machine language, education, and business.**

**New series: Q + A**



# PORTERFIELD

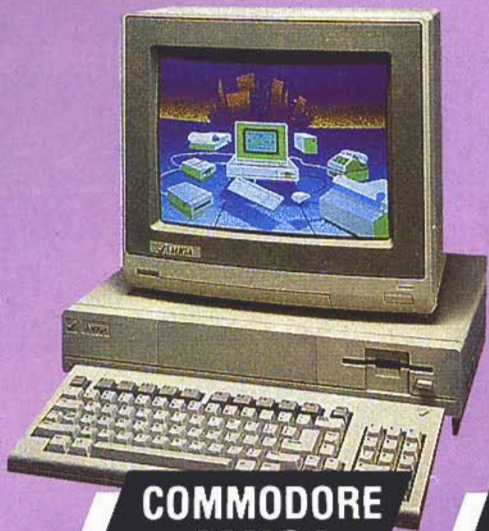

**COMMODORE  
AMIGA**



**ATARI  
520 ST**



**AMSTRAD  
8256**

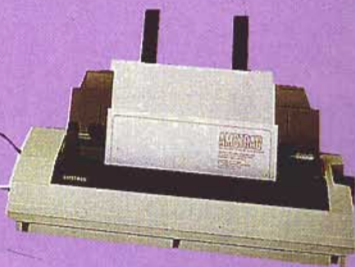

**COMMODORE  
128/D**

ALL MAJOR CREDIT CARDS WELCOME

WELLINGTON:  
Porterfield Computers  
84 Victoria St.,  
Ph: 731-097

**Latest Hardware  
Hottest Software  
Fastest Service**

AUCKLAND:  
Porterfield Computers  
415 Dominion Rd.  
Ph: 686-084

# PORTERFIELD



# To finance your future in tourism

When you are ready to turn your vision into a commercial reality, you'd see the people who have financed New Zealand businesses for over 40 years.

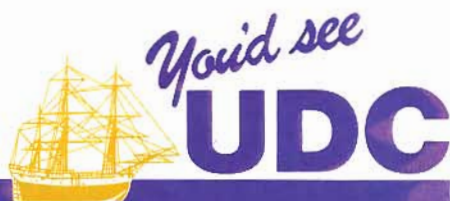

UDC Finance Limited





IT'S HERE!

# Now making an intelligent decision is easy!

## COMMODORE 128 Personal Computer

### Bridging the gap between home and office!

Commodore have done it again. With three computers in one, the Commodore 128 is the turning point in personal computing. Powerful versatility. Crammed full of brilliant options. Amazing sound and graphics and three times the user-available memory of its competitors with 128k of RAM. Well established software for every home, educational and business use. Now for the first time ever you can bridge the gap between home and office with the flick of a switch to run your business, assist with home education, or even take a break and play games with the kids. Commodore 128; powerful versatility in a personal computer.

#### 64K Mode

In this mode the Commodore 128 reproduces all the features of the Commodore 64, the worlds top-selling home computer, making it ideal for the first time user or for experienced 64 owners wanting to upgrade. Best of all - existing 64 software and peripherals are instantly compatible.

#### 128K Mode

In its native mode the 128 really begins to break new ground with 119.5 KRAM available to the user to program in BASIC. Expandable to 512K. Over 140 commands in BASIC 7.0 for logical, structured programming making sound and graphics easy to master. Built in machine language monitor, 80 or 40 columns display (ideal for word processing). A 14 key numeric keypad, and more!

#### CP/M Mode

Using the Z80A microprocessor the 128 transforms into a business computer running CP/M Plus version 3.0, the latest version of the most popular business operating system for 8 bit micro computers. Famous programs such as dBase II, Wordstar, Calc-star and all of the most used applications together with many specialist packages; 80 columns. The C128 CP/M mode reads various 5 1/4" CP/M disk formats.

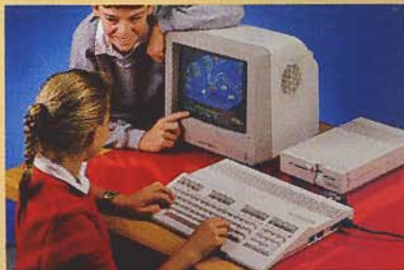

**Business Partner, Manager, Artist, Poet, Novelist, Mother of 3, Game's Master, Teacher, Student, Mechanic, Musician...**



**Commodore 128 Personal Computer is Your computer**

*Find out more!*

**COMMODORE 128**  
Personal Computer  
the intelligent decision!

COMMODORE COMPUTER (NZ) LTD  
P.O. BOX 33-847, TAKAPUNA  
AUCKLAND. PHONE (09) 410-9182

**Yes!** Please tell me more about the amazing C128

NAME \_\_\_\_\_

ADDRESS \_\_\_\_\_

\_\_\_\_\_

PHONE \_\_\_\_\_

**MAIL TODAY!**

AG88 7



# Order now and Save!!

Overleaf are order forms for subscriptions, back copies, books and binders.

Simply enter what you require and place one or both forms in an envelope with your payment.

No stamp is required if you address your envelope.

**FREEPOST No. 125  
BITS & BYTES  
BOX 827  
CHRISTCHURCH**

(Credit card holders don't even need an envelope. Just fill out the card details, seal the two forms together with sellotape and post ensuring our Freepost address is on the outside.)

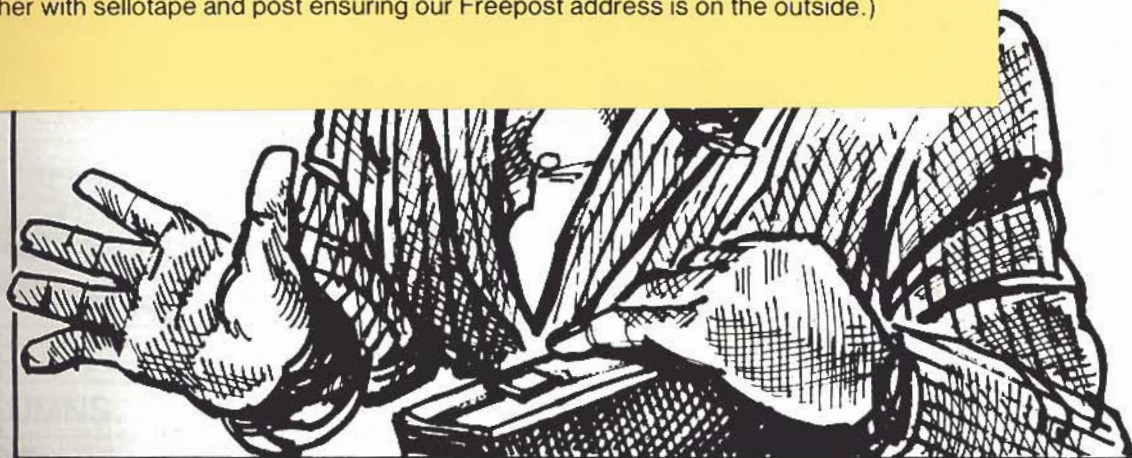

**If the salesman tells you he doesn't stock STAR printers — you better think twice about buying his computer!**

When we select a dealer for our Star printers, we ask ourselves the following questions:

- One — Would WE buy a computer off this guy?
- Two — Is he going to be here this time next year?
- Three — Is he just out there to make a fast dollar?
- and Four — Would we let one of our daughters marry him?

**When you buy a STAR — you buy the best.**

**star** 

Distributed by:  
Genisys Systems Ltd.,  
47 Station Rd, Otahuhu.  
Ph. 276-734, 276-6361  
P.O. Box 6255, Auckland.

Distributed in Australia by:  
Genisys Systems Pty Ltd.,  
26 Norton Street,  
Leichhardt 2040.  
N.S.W. Australia.



# How much should you spend on computers?

Look at these prices and then decide.

|   | Retail Price |  | Retail Price |
|---|--------------|--|--------------|
| <b>SYSTEM UNITS</b>   |              | <b>STREAMING TAPE SUBSYSTEMS</b>   |              |
| IPC-XT 256K/2x360K Floppies/Par/Monitor.....  | \$2,275      | 10 MByte Irwin Tape Backup (Internal) PC/XT/AT.....  | \$1,650      |
| IPC-XT 640K/2x360K Floppies/Par/Ser/Game/Mon/Clock.....   | \$2,575      | 24 MByte Irwin Tape Backup (Internal) AT only.....   | \$1,825      |
| IPC-XT 640K/2x360K FI/Par/Ser/Game/Mon/Clock/10Mb.....  | \$4,150      | 24 MByte Irwin Tape Backup (External) AT only.....   | \$2,600      |
| IPC-XT 640K/2x360K FI/Par/Ser/Game/Mon/Clock/20Mb.....  | \$4,450      | 10 MByte Irwin Tape Backup (External) PC/XT/AT.....  | \$2,000      |
| IPC-AT 20Mb Hard Disk/1.2Mb Floppy/Mon.....   | \$6,850      | 60 MByte Archive Tape Backup (Internal) PC/XT/AT.....  | \$3,225      |
| MAGNUM TURBO 4.77/8.0MHz/640K/1x360K FI/Mon/MS-DOS.....   | \$2,290      | 60 MByte Archive Tape Backup (External) PC/XT/AT.....  | \$3,575      |
| MAGNUM TURBO 4.77/8.0MHz/640K/2x360K FI/Mon/MS-DOS.....   | \$2,590      | All Streaming Tape Subsystems include: Cables, Manuals, Operating Software and (for external models) Case and Power Supply.  |              |
| MAGNUM TURBO 4.77/8.0MHz/640K/1x360K FI/10Mb/Mon/MS-DOS.....  | \$4,290      | <b>REMARKABLE DISKETTES</b>  |              |
| MAGNUM TURBO 4.77/8.0MHz/640K/1x360K FI/20Mb/Mon/MS-DOS.....  | \$4,790      | DSDD Premium Quality 5 1/4" (Suitable for most PC's).....  | each \$4.50  |
| MAGNUM TURBO 4.77/8.0MHz/640K/1x360K FI/40Mb/Mon/MS-DOS.....  | \$7,190      | QUAD Premium Quality 5 1/4" (To 1.2Mb).....  | each \$8.50  |
| GALAHAD PORTABLE 512K/1x360K/80x25 LCD/Par/Ser/CI/PC-DOS.....   | \$4,995      | SSDD Premium Quality 3 1/2" (To 400K).....   | each \$7.00  |
| <b>MONITORS AND GRAPHICS CARDS</b>  |              | DSDD Premium Quality 3 1/2" (To 850K).....   | each \$8.50  |
| MAGNUM Green Monitor.....   | \$295        | Remarkable Diskettes are US-made, come boxed with Tyvek Sleeves, Labels, Write Protect Tabs, exceed all ANSI standards. Each track certified 100% error free, non-woven dust free internal liners, Replacement Guarantee.  |              |
| Thomson Mono Monitor (Composite).....   | \$395        | <b>GENERIC DISKETTES</b>   |              |
| White Knight Hi-Res (TTL) Mono Monitor.....   | \$420        | DDSD 5 1/4".....   | \$3.50       |
| MAGNUM Flat Green Screen.....   | \$450        | Japanese made, Boxed, Write Protect, Labels, Replacement Guarantee.  |              |
| MAGNUM Flat Amber Screen.....   | \$495        | <b>UPGRADES</b>  |              |
| Thomson RGB Colour Monitor.....   | \$1,070      | Multi I/O Card - Floppy Drive/Par/Ser/Clock/Game.....  | \$175        |
| White Knight Hi-Res Colour (640x350) plus controller.....   | \$2,345      | 4.77 MHz Multifunction Board 0K.....   | \$275        |
| White Knight Colour Graphics Card (2 RCA Ports).....  | \$150        | 8 MHz Multifunction Board.....   | \$375        |
| White Knight Mono Graphics Card.....  | \$195        | 4.77 MHz Multifunction Board WITH 384K.....  | \$475        |
| MAGNUM Colour Graphics Card.....  | \$350        | 8087 Co-Processor.....   | \$445        |
| MAGNUM Mono Graphics Plus Printer Card.....   | \$395        | Hercules Compatible Graphics Card.....   | \$325        |
| <b>WINCHESTER DRIVES</b>  |              | RS232 Card.....  | \$125        |
| 25 Mb Seagate, HH, ST225, 65ms.....   | \$1,535      | Parallel Card (Centronics).....  | \$49         |
| 38 Mb Seagate, FH, HiPerf, Self Park, 38ms.....   | \$2,525      | 64K Chips - 64K 150ms DRAM.....  | \$190        |
| 51 Mb Seagate, FH, HiPerf, Self Park, Plated, 38ms.....   | \$2,880      | 240v 135 Watt Power Supply.....  | \$495        |
| 85 Mb Miniscribe, FH, HiPerf, Self Park, Plated, 28ms.....  | \$5,545      | <b>PRINTERS</b>  |              |
| 85 Mb Toshiba, FH, HiPerf, Self Park, Plated, 22ms.....   | \$6,825      | Panasonic KXP1090-10", Par., 100cps, NLQ, 80-132 Col.....  | \$595        |
| 190 Mb Maxtor, FH HiPerf, Self Park, Plated, 27ms.....  | \$15,900     | Panasonic KXP1091-10", Par., 120cps, NLQ, 80-132 Col.....  | \$745        |
| Omti HD Controller Card.....  | \$495        | Panasonic KXP1092-10", Par., 180cps, NLQ, 80-132 Col.....  | \$1,150      |
| <b>HARD DISK SUBSYSTEMS - PC/XT</b>   |              | Panasonic KXP1592-15", Par., 180cps, NLQ, 136-230 Col.....   | \$1,550      |
| 20 Mb HH Seagate ST225 65ms.....  | \$1,995      | Dataproducts 8020/21/22-15", Par./Serial, NLQ, 180cps.....   | \$1,295      |
| 31 Mb FH Seagate 40ms Self Park.....  | \$2,895      | Dataproducts 8070/71/72-15", Par./Serial, - Colour Avail.....  | \$3,795      |
| 42 Mb FH Seagate 40ms Self Park, Drive Splitting BIOS, Plated.....  | \$3,935      | Dataproducts DP-295 Daisywheel Par./Serial.....  | \$1,295      |
| 71 Mb FH Toshiba 22ms Self Park, Drive Splitting BIOS, Plated.....  | \$6,400      | Toshiba P1351 24 Pin Dot Matrix, 15", NLQ, Par./Serial.....  | \$2,675      |
| 160 Mb FH Maxtor 28ms Self Park, Drive Splitting BIOS, Plated.....  | \$16,600     | Toshiba Bin Sheet Feeder.....  | \$1,650      |
| <b>HARD DISK SUBSYSTEMS - AT</b>  |              | Toshiba Tractor Feed.....  | \$280        |
| 20 MByte HH (with AT rails) 65ms.....   | \$1,825      | Mitsubishi DX120 10", 18 Pin, 120cps, Par., 80-132 Col.....  | \$995        |
| 31 MByte FH (with AT rails) 38ms.....   | \$2,880      | Mitsubishi EP180EX 10", 18 Pin, 180cps, Par., 80-132 Col., 3K.....   | \$1,095      |
| 42 MByte FH (with AT rails) 38ms.....   | \$3,250      | Mitsubishi EP180 15", 18 Pin, 180cps, Par., 136-230 Col., 3K.....  | \$1,495      |
| 71 MByte FH (with AT rails) 22ms.....   | \$6,050      | Mitsubishi DX180 10", 18 Pin, 180cps, Par., 80-132 Col., 15K.....  | \$1,345      |
| For all external Half Height Drives add.....  | \$760        | Mitsubishi DX180W 15", 18 Pin, 180cps, Par., 136-230 Col., 15K.....  | \$1,695      |
| For all external Full Height Drives add.....  | \$950        | Juki 6100, Daisywheel, 15", Bi-Directional, 18cps, Par.....  | \$1,520      |
| All hard disk subsystems include: Drive, Controller, Cables, Manuals, Hard Disk Booting BIOS ROM, Firmware Hard Disk Preformat program, Park Utility on Oxide media drives and (for external models) Case and Power Supply. |              | Juki 6300, Daisywheel, 15", Bi-Directional, 40cps, Par.....  | \$3,450      |
| ALL DISK SUBSYSTEMS FITTED FREE OF CHARGE.  |              | All prices subject to change without notice.<br>All prices include Sales Tax.<br>Computers are 100% MS-DOS Compatible with 12 Month Guarantee.<br>Diskettes carry No-Questions-Asked Replacement Guarantee.<br>Printers carry 90 Day Guarantee.<br>DEALER ENQUIRIES WELCOME. |              |
| <b>FREIGHT AND PACKAGING</b>  |              |  |              |
| 5% for orders under \$100. \$7.50 for orders over \$100.<br>Systems, Printers, Monitors \$50 per package.   |              |  |              |

## To order use this form:

Please supply the following:

NAME: \_\_\_\_\_  
 COMPANY: \_\_\_\_\_  
 ADDRESS: \_\_\_\_\_  
 CITY: \_\_\_\_\_  
 PHONE No: \_\_\_\_\_  
 Cheque Enclosed  Please charge my credit card   
 Visa  American Express  Diners Club  Bankcard   
 Card Number: \_\_\_\_\_  
 Expiry Date: \_\_\_\_\_

Signature: \_\_\_\_\_  
 All orders must be accompanied by a cheque, money order, postal note or credit card number.  
 All orders must be signed. Your money will not be banked until after your order is despatched.

For even faster service call (024) 774 464

## REMARKABLE ENTERPRISES LTD

(Computer Division)  
 7 Crawford Street, Dunedin  
 Freepost 191, P.O. Box 1415, Dunedin  
 Telephone (024) 774-464, FAX (024) 772-948  
 Telex NZ 5406 REMPAP

For further information and a complete price list of MS-DOS Computers, Tape Units, Diskettes, Printers and Software, call or write today.





# BITS & BYTES

July 1986 Vol. 4, no. 10



## COLUMNS:

|                  |    |
|------------------|----|
| Amstrad          | 58 |
| Apple            | 59 |
| Atari            | 61 |
| Commodore        | 62 |
| BBC              | 65 |
| Sega             | 67 |
| Spectrum         | 69 |
| Spectravideo     | 71 |
| Machine Language | 73 |

|   |       |
|---|-------|
| NEWS  | 8-12  |
| REVIEW: Portables in vogue again, says Peter Biggs  |       |
| Data General One / Model Two  | 13    |
| Toshiba T1100   | 16    |
| SOFTWARE AWARD: a close-up of<br>NZ Software Award winner, Soft-Tech                          | 20    |
| UK REPORT 2: Micros joined with video graphics,<br>as seen by Pip Forer.                      | 21    |
| MICROS AT WORK: a business perspective  | 25    |
| REVIEW: The Star SG 10 dot matrix printer,<br>tested by Grant Collison                        | 26    |
| REVIEW: Superscript for the C64, by Andrew Mitchell   | 27    |
| CATALOGUE:<br>for The 1986 WELLINGTON COMPUTER SHOW,<br>this year focussing on communications | 29-52 |
| QUESTIONS and ANSWERS:<br>Geoff McCaughan's class   | 54    |
| PASCAL: Two "real" Pascal options for the C64,<br>run by Andrew Bevin                         | 56    |
| BANK-SWITCHING: How come 80K ram is actually<br>21K of useable ram, eh? The debate...         | 74    |

**BITS AND BYTES** magazine is published monthly (excepting January) by Bits and Bytes Ltd, Denby House, third floor, 156 Parnell Road, PO Box 9870, Auckland 1. Phone 796-776, 796-775. **EDITORIAL:** managing editor, Gaie Ellis; editor, Steven Searle; Christchurch reporter, Dion Crooks, 66-566. **ADVERTISING:** Auckland - PO Box 9870, 796-775; Wellington - Vicki Eckford, 753-207; Christchurch - Jocelyn Howard, PO Box 827, 66-566. **SUBSCRIPTIONS:** First floor, Oxford Court, 222 Oxford Tce, Christchurch, PO Box 827, Phone 66-566. Manager, Mavis Shirtcliffe. **SUBSCRIPTION RATE:** \$18 for 11 issues, school pupils rate \$16. Overseas subs are \$27/year surface mail, and airmail rates of \$59 (Australia, South Pacific), \$86 (North America and Asia), and \$108 (Europe, South America, Middle East). **BOOK CLUB:** manager, Dion Crooks, at above Christchurch address, 66-566. **DISTRIBUTION INQUIRIES:** bookshops to Gordon and Gotch Ltd, computer stores to publisher. **PRODUCTION:** graphic designer, Roger Guise; Typesetter, Monoset; printer, Rodney and Waitemata Times. **DISCLAIMERS:** The published views of contributors are not necessarily shared by the publisher. Although all material in Bits and Bytes is checked for accuracy, no liability is assumed by the publisher for any losses due to use of material in this magazine. **COPYRIGHT:** All articles and programmes published herein are copyright and are not to be sold or distributed in any format to non-subscribers of Bits and Bytes.



## Remarkable sale to film industry

Remarkable Enterprises is renown for its direct mail business based in Dunedin, delivering IBM-compatible hardware and imported software.

But Remarkable announced this month an outstanding sale of its own software, developed specifically for the film and drama production industry.

The Australian Broadcasting Corporation has confirmed its purchase of \$250,000 worth of Remarkable's Film Management System and FilmTrack.

FMS is an accounting and budgeting suite of programmes, and FilmTrack provides a breakdown, analysis and

scheduling of film or drama production work.

The software concept was designed by Remarkable director Noel Ferguson, and the programme engineering was by software engineer Laurens Meyer, who is full-time with Remarkable.

ABC bought 45 of the units and will establish them in offices of ABC and amongst production departments.

The project has been under development for four years, FMS first being introduced to the US market in 1982. A few sites were installed.

The latest version is a Clipperised

dBase version, rewritten completely since August.

Remarkable's marketing director, Richard Barker, says he believes ABC took some six months evaluating a dozen programmes.

The sale was through an affiliate, Remarkable Film Computers, in Sydney, where back-up, training and support facilities are being extended.

"We now feel this software could be accepted as a film industry standard worldwide," says Barker, adding that the ABC purchase had already aroused new interest in the US.

## How much should you spend on software?

Look at these prices and then decide.

| SOFTWARE  | Retail Price | PC-SIG LIBRARY SOFTWARE  | Retail Price |
|---|--------------|--|--------------|
| Samna III.....  | \$995        | Catalogue - Hundreds of titles that will save you money.....       | \$49.95      |
| Samna Legal Dictionary.....   | \$399        | PC-Write Ver. 2.6 - Top Word Processor.....                        | \$29.95      |
| Samna Plus.....   | \$1,295      | PC-Deskmates - A super alternative to Sidekick.....                | \$29.95      |
| Word Perfect 4.1.....   | \$895        | PC-Outline - Similar to "Ready" and "Thinktank".....               | \$29.95      |
| Typing Tutor.....   | \$85         | PC-Calc - General Purpose Spreadsheet.....                         | \$29.95      |
| dBase III.....  | \$1,095      | PC-General Ledger - Complete audit trail available.....            | \$29.95      |
| Clipper.....  | \$950        | PC-DOS Help - Online Help for DOS commands.....                    | \$29.95      |
| Lotus 123 Ver. 2.0.....   | \$995        | PC-Draw #1 - Create and edit graphics screens.....                 | \$29.95      |
| Open Access.....  | \$1,345      | 123 Worksheets #2 - Loans/Chequebook/Stocks/Printer Control.....   | \$29.95      |
| Borland Sidekick Ver. 1.5 (Unprotected).....                        | \$175        | 123 Macros - Ratio Analyser, Loan Payoff Calculator & more.....    | \$29.95      |
| Borland Sidekick Ver. 1.5 (Protected).....                          | \$125        | Touchtype - Typing Tutorial, Turn you PC into a typewriter.....    | \$29.95      |
| Borland Turbo Editor Toolbox.....                                   | \$145        | Ultra Utilities - Useful Tools for every PC Owner.....             | \$29.95      |
| Borland Turbo Database Toolbox.....                                 | \$139        | Patches - Allows you to make backups of selected software.....     | \$29.95      |
| Borland Turbo Gameworks.....  | \$145        | Diskette Utilities - Includes RAMDISK Utilities.....               | \$29.95      |
| Borland Turbo Graphix Toolbox.....                                  | \$100        | Best Utilities - A collection of the best in the library.....      | \$29.95      |
| Borland Turbo Tutor.....  | \$99         | Copy Protection/Unprotection Utilities.....                        | \$29.95      |
| Borland Lighting.....   | \$225        | Best Games - A collection of the best in the library.....          | \$29.95      |
| Borland Turbo Pascal Ver. 3.0.....                                  | \$150        | Spacewar - Excellent asteroid type arcade game.....                | \$29.95      |
| Borland Turbo Pascal with 8087 Ver 3.0.....                         | \$225        | Arcade Games - Colourful games - great on JX.....                  | \$29.95      |
| Borland Reflex.....   | \$275        | Game Mixture - 12 games on Disk.....                               | \$29.95      |
| Borland Prolog - NEW.....   | \$325        | Miscellaneous Games - Educational, video and adventure.....        | \$29.95      |
| Microsoft Windows.....  | \$190        | ANY TWO LIBRARY DISKS ONLY \$19.95 EACH. BULK DISCOUNTS AVAILABLE. |              |
| Microsoft Pascal.....   | \$625        |  |              |
| Fastback.....   | \$295        |  |              |
| Keyworks.....   | \$195        |  |              |
| Ready.....  | \$125        |  |              |
| Norton Utilities Ver. 3.1.....                                      | \$245        |  |              |
| Crosstalk XVI.....  | \$335        |  |              |
| Profax (N.Z. made) - Top software - GL/AR/AP/PO/Inv - NEW.....      | \$1,495      |  |              |
| Dac Easy (US Ver.) GL/AR/AP/PO/Billing/Inv./Forecasting.....        | \$250        |  |              |
| Timeline Ver. 2.0 Project Scheduling Easy to use/Top Performer..... | \$845        |  |              |
| Before You Leap - Cocomo-based Software Dev. Cost Model.....        | \$995        |  |              |
| Generic CADD - NEW.....   | \$495        |  |              |
| Ribbon Re-inking.....   | CALL         |  |              |

All prices subject to change without notice.  
All prices include Sales Tax.  
DEALER ENQUIRIES WELCOME.

**FREIGHT AND PACKAGING**  
5% for orders under \$100. \$7.50 for orders over \$100.

### To order use this form:

Please supply the following: \_\_\_\_\_

NAME: \_\_\_\_\_

COMPANY: \_\_\_\_\_

ADDRESS: \_\_\_\_\_

CITY: \_\_\_\_\_

PHONE No: \_\_\_\_\_

Cheque Enclosed  Please charge my credit card   
 Visa  American Express  Diners Club  Bankcard

Card Number: \_\_\_\_\_

Expiry Date: \_\_\_\_\_

Signature: \_\_\_\_\_

All orders must be accompanied by a cheque, money order, postal note or credit card number.  
All orders must be signed. Your money will not be banked until after your order is despatched.

For even faster service call (024) 774 464

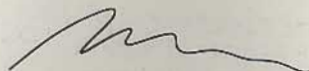

### REMARKABLE ENTERPRISES LTD

(Computer Division)  
7 Crawford Street, Dunedin  
Freeport 191, P.O. Box 1415, Dunedin  
Telephone (024) 774-464, FAX (024) 772-948  
Telex NZ 5406 REMPAP

For further information and a complete price list of MS-DOS Computers, Tape Units, Diskettes, Printers and Software, call or write today.



## Symphony and ITT for NZ News

NZ News Ltd has recently purchased 28 Symphony packs of software and 44 ITT Xtra micros.

Tony Burns, PC specialist for the company, which controls more than 40 other companies, said the choices were based on having well-supported, upgradeable and reliable standards adopted for NZ News' microcomputer systems.

Burns also preferred dealing directly with a micro manufacturer, through NZ subsidiary STC, rather than through intermediaries or independent distributors.

The software, he says, was also well supported, by Imagineering, and their

training facilities would mean NZ News users of Symphony would not be totally dependent on in-house expertise.

"If I leave, for instance, this system will not be affected but keep running on 'off the shelf' expertise," says Burns.

Symphony was chosen as a product, he says, because it had spreadsheet enhancements like a macro library, and an excellent tutorial.

The integration of "relatively decent" database and wordprocessor was also important because training requirements for these additions were minimal.

A bonus was Symphony being readable by Paradox (a database manager) and enabling programming to format

Symphony data acceptable to NZ News' DEC VAX minis... the programming by an ATI student, Tim Sutton, took just nine days using Paradox.

NZ News' computer centre manager, Pat Rossiter, says management and accounting micros enabled work functions not available on the seven VAX minis except at a higher price - for example, a resource accounting package on VAX costs \$10,000-plus compared with Superproject on the micro for under \$1000.

The micros and Symphony are to enable the group's companies to individually create dependable budgeting plans.

## Microbee buzzing again

After two jerky starts in the NZ micro market Microbee (Australia) has again opened the doors for business at its base in Auckland's Avondale.

The new premises (leased) had been unmanned since last December for several months while more urgent business in Australia was sorted out.

Then about April Microbee's projects manager, Trevor Smith, arrived here to wave his company's flag.

Among Smith's initial moves was to find a manager for Microbee Systems NZ Ltd, a company whose presence in the interim had been represented by a sole salesperson in Wellington, working from home.

Recently Smith announced the appointment of Jason Fletcher, a Kiwi with a predominant sales (not micros) and management background, as the new manager. Smith is now seeking a technical consultant to work in tandem with Fletcher.

The Wellington representation will also be strengthened.

Giving the latest push added impetus is the early July launch of a new IBM-compatible portable from Microbee which was intended to retail for less than \$1900.

The Microbee/Mitac Portable PC is a keyboard-and-computer unit selling in Australia for A\$1495, and Smith says he wants the NZ pricing to be at the same level (plus exchange rate differences and shipping).

The unit, resulting from a technical exchange deal with Mitac in Taiwan, is manufactured in Taiwan and has only one obvious disadvantage - no monitor.

An LCD option will come in a few months, but Smith says there will be more interest in hooking such a low-cost portable to standard monitors. Microbee's choices are its mono at \$199, and colour at \$549.

In concept it is like the Apple IIC, with a built-in disc drive, but the M/M portable will be sold on the strength of running industry standard (IBM) software.

Other standard features of the Microbee/Mitac portable are:

- \* 80C88 c.p.u.
- \* MS-DOS 3.1
- \* colour graphics adaptor
- \* 256 K ram (640 K option)
- \* a 360 K floppy drive (5.25 inch)
- \* undetached keyboard with numeric pad
- \* real-time clock
- \* two serial ports
- \* a centronics port
- \* expansion port for second drive
- \* expansion port for hard drive

Options are a mouse, and carrybag. Smith says the NZ company will have "heaps of support" from its Australian parent.

Market targets are various, he says, and one new direction is to bundle locally developed business software (from MLS) with Microbee's CPM micros - a hardware and software bundle to cost less than \$4000.

## Toshiba busy

Toshiba has declared "the semiconductor depression is over." Toshiba's overall output of semiconductors, including diode and 256K DRAM, has exceeded one billion sets.

Currently Toshiba is meeting a flood of purchase orders for its semiconductors from manufacturers in the South-east Asian countries.

## THE FLOPPY DISC EXPRESS

Schools, universities, Government Departments and over 3,000 hackers have been taking advantage of the sharpest prices available on our peripherals for over 3 years.

JOYSTICKS (for 2+, 2E & PC): \$69.95  
Is self-centring & free floating.

512K/80 COLUMN ENHANCE FOR 2E: \$450  
Runs PRODOS, CPM, DOS 3.3, & PASCAL.

NUMERIC KEYPAD FOR 2E: \$85  
For quick and easy numeric entry.

GRAPHIC MOUSE FOR 2+ & 2E: \$125  
Draw on screen, save, & print.

DISC NOTCHER - DISC DOUBLER: \$14.95  
Now use both sides of a disc.

EBONIZE RIBBON RE-INKER: \$49.95  
U.S. made ink aerosol spray. Reinks up to 20 printer ribbons.

GENESIS S6-10 PRINTERS: P.O.A.  
Best value draft & NLQ dot-matrix.

APPLE SLIMLINE DRIVES: \$375

APPLE 5MEG HARD DISC & I/F: \$1200  
Runs both PRODOS & PASCAL.

Plus we stock dozens of different Apple compatible expansion cards, surge suppressors, paper, floppies and disc storage boxes. Write for FREE catalog. All goods guaranteed. We accept Visa, Bankcard, or cheque. Ph: (09) 760-150 (7 days), or write:

*The Floppy Disc  
Express Co.*

BOX 39-163, AUCKLAND



## Computer Imports carries on

Computer Imports Ltd, the distributor of IBM-compatible Sigma and Exzel micros, recently announced a new machine, the Exzel XL.

This is despite a High Court injunction, according to IBM, ordering CIL to cease importing and trading any computer silicon chips reproducing IBM BIOS or Mega BIOS programmes.

CIL also had to cease selling PCs having similar cabinet fronts to IBM's.

A court hearing is due.

But Computer Imports has reported the injunction effectively being "reduced", enabling CIL to continue selling its Exzel XT because of a changed cabinet front, and different ("better") BIOS.

The BIOS was apparently changed four weeks before the court injunction was initiated.

The Exzel XT, with a 10 Mb hard-

drive, is selling for \$3990 – a \$2000 drop on the former XT price. The drop, says CIL, is due to a good deal on hard drives from the US.

CIL reports it is still selling bulk orders of the XT; another 30, for example, recently bought by the Broadcasting Corporation of NZ. CIL has also established a shop in Willis Street, Wellington.

Meanwhile the Exzel XL has the "functionality of a normal (IBM) XT", but is readily upgradeable to AT specifications, claims CIL.

With a 20 Mb hard-drive it sells \$6,500 (including mono screen).

Meanwhile, in Taiwan, IBM Taiwan Corporation has claimed agreement with 13 local manufacturers in connection with alleged violations of IBM copyright.

Legal action has been taken against six other Taiwanese manufacturers by IBM Taiwan.

## Monopoly over

Unlike the US, with its three main dial-up data networks – Telenet, Tymnet and Uninet – British Telecom has had the monopoly on data networking in the UK.

Mercury Communications looks like changing that as their network comes gradually onstream during '86.

Now the market for dial-up communications look set to take another turn as the Midland Bank get in on the act!

Starting this August, Midland Bank plan on expanding their data network to include public access.

The new network will be called Fas-trak and offer 3,000 access ports at more than 70 locations dotted around the UK, thus catering for 99 per cent of the UK with local call access – something with which BT's Packet Switch Stream currently cannot compete.

## Australian award

Auckland's Cowan Bowman Associates has won the business software section of the PC86 PC Awards in Melbourne.

The winning package, CBA, is now a top-selling accounting package in both New Zealand and Australia and was rated above entries from several countries, including the USA.

CBA has recently established a joint company in Australia, going halves with Intelligence (Aust) Pty, a former CBA distributor, in Automation One.

## ST to Mac, but then where?

"MacCartridge", being funded by Data Pacific in California, was shown to make "nearly 99%" of Macintosh software run on the Atari ST.

It is composed simply of a plug-in cartridge installed with 64K Macintosh ROM chips, and software. But "MacCartridge" may never see the light of day because Apple attorneys, who have the case in hand, may see the product as a copyright violation.

## Apple lops dealer network

Apple has told about 600 Apple dealers in the US that they are no longer authorized to sell Apple products.

This leaves some 2,000 current dealers, which Apple says represent 90% of its sales.

Among those eliminated was the Sears Business Systems chain of 106 stores.

Meanwhile, for the chosen 2,000, Apple is offering an "Apple Fund" which will provide them with \$10 million in advertising and marketing funds.

## Price bashing

The price bashing in the PC market is now escalating into the super-micro and mini markets, according to dp consultancy Arthur Young and Associates.

Again the Asia-based manufacturers are leading the assault, offering super-micros, for instance, at 60 percent of competitors' prices.

Young's Richard Ord says the Asian products are gaining acceptance even at this higher level of the computing market.

At the PC level, Ord says one building society recently sourced 200 micros from Taiwan.

Similar pressures would be applied in the mini market, says Ord, when buyers compare the typical cost of \$300,000 for a mini installation with an Asian system costing \$150,000.

## Flat-panel display

Hitachi has developed a prototype of an ultra-large plasma display with a screen size of 40 inches.

It is only 8-mm thick.

The power consumption rate is low, while the screen gives an extremely clear image.

According to a published report, Hitachi has applied for 50 or 60 patents on this plasma display, and plans to release a "wall-hung" colour TV with this display within three years.

## City links

The Manukau City Council is installing a Case network to link its property, land and library databases to enable more flexible access from staff terminals.

## HP drops prices

Hewlett-Packard NZ had dropped its Vectra PC prices by 12 to 22 percent, the entry level now being \$6989.

The Touchscreen II dropped \$1400 to \$7319.

## Control in repairs

Control Electronics has announced its specialisation in the maintenance of computers of various brands (including clones) and their peripherals.

The Mt Eden workshop is manned by three engineers, and service manager Barrie Reynolds says most repairs would be completed within one day of receipt.



## Future for Atari

Atari executives Sam and Leonard Tramiel, in a panel discussion at the US West Coast Computer Faire, offered a few hints of things to come.

"Atari will move aggressively into desktop publishing," said Leonard, who said several companies are preparing an imminent release of computer-aided design products for the ST.

He promised that the new version of Digital Research's GEM operating system will not be released for the ST "until all the bugs are worked out of the system."

The younger Tramiel also said that the CD ROM player, which was due out last December, is totally in the hands of Gary Kildall's KnowledgeSet (formerly Actventure); its release date is unknown. "Atari is not getting aggressive in CD ROM," Leonard revealed.

He said an 80-column card for the company's 8-bit line of computers is "almost finished" and will show at Comdex in Atlanta with production scheduled for late June.

A module that allows the ST to run CP/M programs, now for sale in Europe, will be more widely available.

## 3 1/2 inch momentum

Is there a hint of a new drive standard in IBM's installation of 3 1/2 inch disc drives in first the JX and now the PC Convertible?

IBM has revealed also that 16 major software producers have agreed to put their programs on 3 1/2" format to accommodate the Convertible and 3 1/2" drives for the XT and AT. Among them are Microsoft, Lotus, Living Videotext, Microstuf, Ashton-Tate and Alpha Software.

Both Borland International and MicroPro have also announced that their entire product lines are now available in 3.5" diskette formats to accommodate the new IBM Convertible.

MicroPro is offering owners of its current word processing software on 5.25" disks a chance to exchange their originals for 3.5" format at a cost of US\$20 plus materials.

Borland is doing the same but at a lower price - \$10 disk.

## Ashton-Tate to spread risks?

Software manufacturer Ashton-Tate claims that the dBASE II and III families of data base management products comprise at least 79% of the firm's overall annual sales.

This disclosure was part of a new 1.3-million share public stock offering the company launched recently.

Ashton-Tate also markets Framework and Framework II. In addition, the company's MultiMate product line accounted for only 5% of Ashton-Tate's annual sales last year.

A new product, Javelin, has been acquired for the Ashton-Tate stable and can be seen as an attempt to diversify.

## Mac Flight

Microsoft has released a version of "Flight Simulator" for the Macintosh. There are five scenery data bases (starting with takeoff from San Francisco), and a player can view his progress from three different perspectives) the cockpit, control tower or spotter plane.

# 1,2,3 and 4 Screens on a single Personal Computer!

**MLS**
**SOFTWARE**

 PO BOX 83-091 EDMONTON.  
 AUCKLAND 8; PHONE 837-0305

- \* Integrated Accounting Software from \$1595
- \* Integrated Manufacturing Software from \$2495
- \* Integrated Wholesalers Software from \$1595

 MAIN MENU  
 STOCK  
 DEBTORS  
 CREDITORS  
 ETC.

+

 MAIN MENU  
 STOCK  
 DEBTORS  
 CREDITORS  
 ETC.

+

 MAIN MENU  
 STOCK  
 DEBTORS  
 CREDITORS  
 ETC.

+

 MAIN MENU  
 STOCK  
 DEBTORS  
 CREDITORS  
 ETC.

=

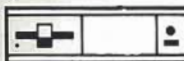
**MLS**  
 SOFTWARE

 Standard Single  
 user P.C.

2nd Screen

3rd Screen

4th Screen

**BOTH USER AND DEALER ENQUIRIES PROMPTLY ANSWERED**



# Orienteering – computing challenge

by Bill Irvine

I was feeling anxious as I ran the program which I had been working on for some months. The computer was set up in a forest near Kawerau some miles from the nearest power source.

The generator which had powered the computer over the previous week drowned away in the background.

500 orienteers were waiting for the results of the seven day event in which they had competed over the previous week in May. In some cases the difference between winning and losing would be small. The prizegiving was scheduled for an hour's time and the program took about half an hour to run.

My computer, a TRS 80 Model 1 is getting old now. It was manufactured in 1978 and on occasions had proved to be a bit unreliable. I hoped that it would not now falter or that my program, tested over and over in my office at home, would not crash.

Members of the organising committee who had kept out of the computer team's way all week, gathered round. They did not share my anxiety. They had faith in computers. They knew what they were capable of. I knew however, of all the things that could go wrong.

Thankfully nothing did go wrong and the results did come out on time. The scheduled prizegiving went ahead and nobody stood up and said that the results weren't correct (that was my worst fear). It was only then that I relaxed a little and reflected on what I had accomplished.

## Seven days

Orienteering is the sport which involves running through forest and over farmland using navigational skills and map and compass to cover a course in

the fastest possible time. Competitors in the seven day international event from May 10-18, came from Australia, Thailand, Switzerland, U.S.A. and Sweden as well as New Zealand.

The venues for the seven days were from Mount Auckland, north of Helensville in the north to an area off the Taupo-Napier road in the south.

The seven day event organising committee approached me to do the data processing for the event in October last year. I started writing the program immediately, had some time off over the Christmas holidays and got back into it in February when entries started coming in. As the event came closer it occupied all of my spare time (and some of my unspare time).

I had good support from a team of helpers during the event.

Computerisation was important because of the complexity of the points system and made the whole administrative task easier.

Competitors started at different times over a two and a half hour period. When a competitor finished, their elapsed time was calculated by the computer and posted on the results board.

Towards the end of the day the computer identified those competitors still out on their courses and gave the all clear when everyone was accounted for.

## Preparations

In the weeks before the event the computer had recorded all the entries and printed mailing labels. It allocated a start time for each competitor for each of the seven days, taking into account peoples' requests for early or late starts and introducing enough randomness to avoid too much consistency between



Bill Irvine – "running" with the TRS 80.

competitors' start time. Lists of competitors were printed numerically, alphabetically and by start time.

Each member of the computer team of three competed in the event. We arrived early and started about an hour before the first official start. We finished our course about an hour to an hour and a half later – just in time to start the generator and type in the first of the competitors' finish times.

Competitors' times were being posted on the results board as soon as ten minutes after they finished. About three and a half hours later, as soon as the last competitor finished, out came the official results for the day and progress points were printed.

At first I had mistrusted the generator, thinking that the power would not be smooth enough for the computer. One of the team who had previously run a computer on a generator for an orienteering event was reassuring. The power from the generator was fed through a power conditioner and proved most reliable.

It was a great experience – but it was a relief to get my computer safely home and know that the job had gone well.

## FASTER THAN A SPEEDING BULLET

Protect your computer with a U.S. made RKS SURGE SENTRY transient suppressor. The faster your PC runs, the more likely it is to be damaged, or data lost by mains conducted spikes. Recommended by leading software consultants for reliable computer operation. Price is only \$249 (freight paid), with 7 days FREE TRIAL.

This unit will stop and dissipate in excess of 1.5 Megawatts of surges over 100 microseconds, and reacts to incoming transients in a super damn fast 5 pico-seconds. To express it another way, a high powered rifle has a muzzle velocity of 3,000 feet/sec (910 m/s), nearly 3 times the speed of sound. In 5 pico-seconds the bullet would have travelled only 5 millionths of a millimetre! What a dawdler!

Simply plugs into mains wall outlet. We run a free advisory service to help solve your surge problems. Plus we stock dozens of different Apple expansion cards, paper, drives, floppies, and disc storage boxes. Write for FREE catalog. All goods fully guaranteed.

We accept Visa, Bankcard or cheque. Phone (09) 760-150 (7 days), or write to: BOX 39-163, AUCKLAND

*The Floppy Disc  
Express Co.*



# Portables again in vogue

by Peter Biggs

Now that summer has come to the Northern Hemisphere and folks are travelling again, two laptop portables have washed up to our shores. One is a genuine laptop and the other an improved version of an already popular standard.

In this review I will look closely at the Toshiba T1100 portable and give a quick preview of a pre-release version of the next Data General portable to follow the DG One – the DG One Release 2.

## DG/One Model 2

Firstly, to the Data General One Model 2.

My review version was a pre-release version of the successor to the well known Data General One laptop.

DG have really tried hard with this one and have listened to at least some of the customer complaints about the original DG/One.

One of the most common was the 'difficult to read' screen.

Two computers arrived here with each of the options now offered by Data General – their latest backlit LCD screen and an electroluminescent screen.

### New screens

The backlit LCD screen was a pale yellow/green with text appearing as dark blue, providing a definitely improved contrast against the background.

The screen size is the same "large size" as on the DG One.

The electroluminescent screen was orange against a stark black background. It could even be read in direct sunlight, but was smaller. I preferred this option for readability. The EL version requires an external rechargeable battery, while the LCD version runs off an internal battery. AC power is also standard for both, as is an output to external monitors.

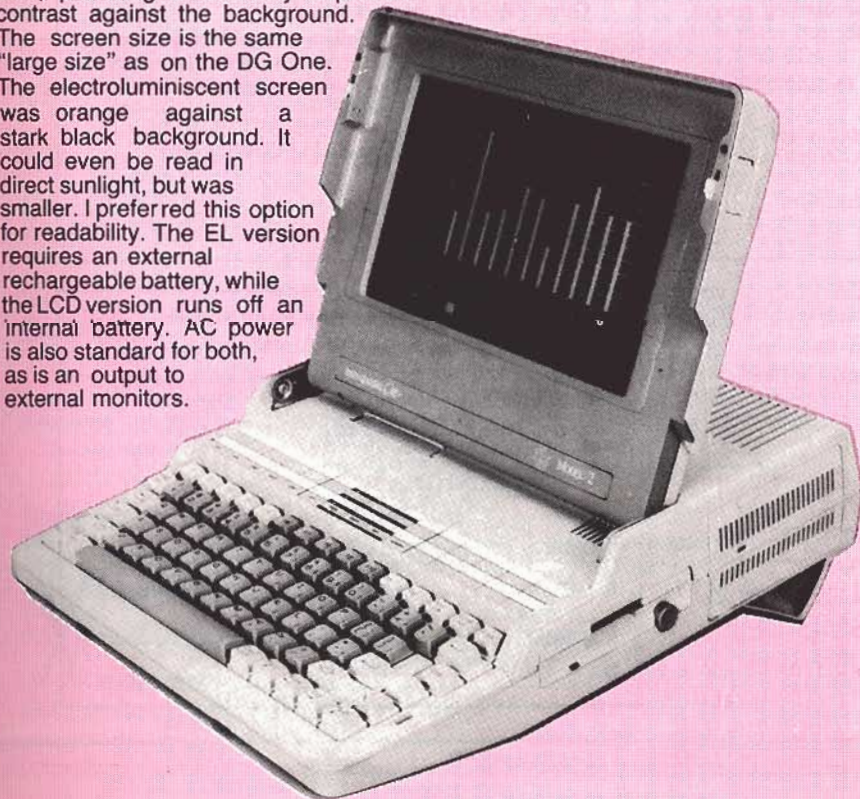

This version had two built-in 3.5 inch drives (standard is one drive), as did the original DG One.

A 5.25 inch drive arrived with it but could not be connected to either computer so I could not test the system much further.

Expansion options also include a portable printer, an expansion box for five IBM PC option cards, and 10 Mb fixed-disc drive.

The keyboard has a quality-feel with small scooped keys and two special keys labelled CMD and SPCL.

Pressing F1 to F4 does not give the usual keyboard buffer commands but F6 gives CTRL Z.

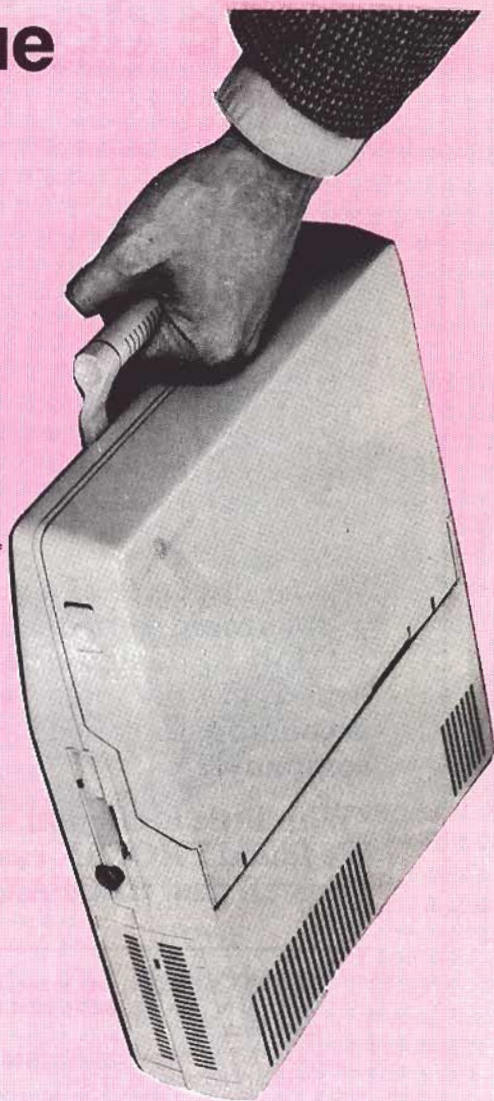

### Ran 'Flight'

The boot disc contained diagnostics. The ROM BIOS was Revision 2 dated 1984/85. Both computers ran Flight Simulator – the only 3.5 inch software I had.

Standard RAM is 256Kb and additional 256 + 128 Kb cards can be installed inside the case for a maximum 640Kb of RAM.

The only other ports were a parallel printer port and a phone port (for a modem). An internal 1200/300 baud modem is another option.

An unusual hole was in the back of the computer which contained two connectors.

No documentation came with the computers so I can say nothing about their use, although the usual DG/One package includes a tutorial disk and easy-to-read manuals.



**“We decided on PROFAX because it gave us the most cost effective solution to streamlining our accounting system.”**

Mr Robert B. Mackeley,  
Managing Director,  
Active Components Ltd.



**“As an importer of a vast range of electronic componentry, we recently evaluated several brands of fully integrated accounting software for our company.”**

**“With little hesitation we decided on PROFAX. We found PROFAX easy to install and with little training our staff find PROFAX very simple to use in day to day operations.”**

PROFAX is the new, easy to use, accounting system designed in New Zealand to meet the real needs of the small business.

PROFAX is completely integrated to handle all your necessary accounting in one.

Accounts Receivable (Debtors Ledger)  
Accounts Payable (Creditors Ledger)  
Invoicing/Sales Analysis  
Inventory Control (Stock Control)  
General Ledger.

Other PROFAX features include:

Comprehensive, easy to follow manual • easy to read screen layout • on screen editing to eliminate errors • immediate selection of options • simple extraction of information for budgeting • no loss of essential data through power failure • handles GST in an efficient way • designed to run on IBM PC, XT and compatible computers.

Ask your local computer retailer to show you PROFAX. Put it side by side with any other accounting system and you will see the difference. Or, if you prefer, send in the coupon for more information.

**PROFAX**

**SMALL BUSINESS  
ACCOUNTING SYSTEM**

Designed and marketed in N.Z. by Logical  
Methods Ltd.

For a free copy of our brochure and for further information, call Auckland 398 105. Or, clip and post this coupon.

To: PROFAX  
Logical Methods Ltd,  
P O Box 37-623,  
AUCKLAND.

NAME: \_\_\_\_\_

COMPANY: \_\_\_\_\_

ADDRESS: \_\_\_\_\_

Ph \_\_\_\_\_ LM861-B&B





## Differences

The apparent differences, or enhancements, over the original DG/One are the screens, being far more legible, the IBM PC-style keyboard, and the options of a hard drive for internal installation, and an 8087 math co-processor.

Less obvious is the dust-free technology and "baked on" circuitry board construction enabling Model 2's crammed yet (hopefully) reliable packaging.

The DG/One M0del 2's communications options are highly relevant to intended sales strategies – initially the unit is to be offered to existing "sites" of Data General's desk-top and Eclipse mini installations.

The new laptop will connect to DG host systems and to other types of networks, including IBM mainframes and PCs.

The latter could be important buyers of this laptop, depending on when (or if) IBM releases its own laptop.

Data General claim their first DG/One has taken an 18 percent share of the laptop market since its launch 18 months ago – but admits the laptop market generally falling short of sales expectations "due in part to weak computer demand".

The Model 2, they say, will build on that market share because of its XT-like enhancements.



## Microcomputer summary

**Name:** Data General/One Model 2

|                           |  |
|---------------------------|--|
| <b>Dimensions:</b>        | 37 x 30 x 8cm  |
| <b>Weight:</b>            | 10.5 lbs., LCD version<br>11.5 lbs., EL version  |
| <b>Processor:</b>         | 80C88, 4 MHz   |
| <b>Memory:</b>            | 256 KB NMOS RAM, expandable to 640 KB  |
| <b>Battery life:</b>      | 2 to 7 hours of normal use, depending on options   |
| <b>Storage:</b>           | 720 KB formatted-capacity compact diskette drive (another 720 KB with second drive, or additional 10 MB with optional hard disk drive)                                   |
| <b>Display:</b>           | EL, 4.8 x 7.6 in (12.2 x 19.5 cm) 640 x 200 pixels with full bit-mapped capabilities. LCD, 7.5 x 10.5 in (19 x 26 cm) 640 x 256 pixels with full bit-mapped capabilities |
| <b>Keyboard:</b>          | DIN standard 79-key alphanumeric   |
| <b>I/O:</b>               | One synchronous, one asynchronous port; bus extension is IBM compatible  |
| <b>Operating System:</b>  | MS-DOS   |
| <b>Power:</b>             | Batteries or AC adapter  |
| <b>Power consumption:</b> | 6 watts average (LCD version); 12 watts average (EL version) @ 20% disk drive duty cycle   |

Review machines from Data General NZ Ltd.

## Myriad grows

The Post Office's videotex service Myriad, hosting the local bodies money market service and a "real time" news service from Radio New Zealand, has recently added "Isaac on Technology".

The column, written by Peter Isaac, has been on the Aditel database for almost two years and appears regularly on Australia's Viatel network.

Myriad is "subscription free" but still costs: \$30 as a one-time registration fee, and time-based charges of 19c per minute (day) and 10c/min (night).

## \$300 grants

National Advanced Systems NZ Ltd, a US-sourced supplier of mainframes, is offering three \$300 grants to third year NZCE students at Auckland Technical Institute, with the option of further assistance.

## Barson booms

Barson Computers Australasia Ltd has scored a supply contract for PCs to the New South Wales Public Services Board, which provides equipment to government and local-government institutions.

Barson will supply Apricot PCs, and peripherals, over the next two years.



## Toshiba T1100

Now, the Toshiba T1100.

Toshiba, the giant Japanese consumer electronics corporation, has certainly packed a lot into a very small space to achieve a genuine laptop portable.

The T1100 is a 256K 16-bit IBM PC compatible micro with an 80 column by 25 line liquid crystal display (LCD) and one 3.5 inch disc drive all packed into a cream coloured shock-resistant plastic package measuring 31.1 x 6.6 x 30.5 cm and weighing only 4.1 kg.

It will fit easily inside a briefcase or alternatively, inside the carry bag available as an option.

Internal NiCad batteries give the T1100 about 8 hours running per charge with moderate disc use, and they can be recharged over 1000 times.

That is, if you used it all day every day for three years the batteries may need replacing – that's not a bad life. A red warning light on the keyboard comes on when the battery gets low at this point only 20 minutes usage remains. Recharging takes about 8 hours and the T1100 can be used while recharging.



### DOS and manuals

The DOS that comes with the computer is MS-DOS 2.11 but it is PC DOS 2.1 and 3.1 compatible.

IBM's BASIC will of course not run on the T1100 and no BASIC is included on the DOS disc.

Two manuals, an Introduction manual and an MS-DOS Manual, come with the computer. The DOS Manual is basically a typewritten copy of the standard DOS manuals and is spiral bound.

The DOS disc also contains a diagnostic utility to check out the computer hardware. A very useful extra.

\$3720 is the price for the standard configuration – a price that is bound to attract interest from a wide range of people who need portability along with an industry standard.

To bring the computer up to 512 K and add a 5.25 inch disc drive will bring the price up to \$5344. There are a full range of optional accessories.

### Keyboard OK

Now to the computer itself. The keyboard has been cut down in size yet all of the standard 83 keys are there. The keys have a good clear touch, are large enough to work with and have the symbols clearly marked.

The main keyboard keys are pale buff while the surrounding function and extra keys are a dark grey. The function and numeric/arrow keys are above the main keys yet I found them reasonably convenient to use.

However, long periods of data entry would be trying – but then this is not its prime function.

The ENTER/CR key is large and conspicuous and the keys are clearly marked with large symbols.

Keyboard appeal is also a matter of personal likes and dislikes, and I found this keyboard satisfactory considering the size of the computer.

### Low power use

In keeping with a small size and true portability, the T1100 has a low, low power consumption – the DRAM memories and CMOS chips consume just 1 watt of power and the disc drive uses just 50 mA of current when operating!

The main processor is a CMOS 80C88 and three special gate arrays reduce the number of discrete components and cut power requirements to the bone.

The case is a tough, shock-resistant, cream coloured plastic. At the left side of the case are the on/off switch and the LCD contrast control wheel. I would have liked to be able to lock the on/off

switch so I could run in my software (eg. Lotus), leave it switched on, and then take it to a conference without the danger of it accidentally being turned off in transit.

### In/out options

There is a port on the back for a RGB colour-composite external monitor and a small switch toggles between the two screens.

(I would use this for reducing power drain while travelling with the computer switched on).

A connection for the special 18V AC adapter and ports for a parallel printer and external disc drive (either 5.25 or 3.5 inch drives) complete the input/output options.

An important feature is the switch to configure either the internal or external drive as the boot drive A.

This means that I could boot up Lotus 1-2-3 on the external drive and use the internal drive for files.

This I consider to be an absolutely essential feature in order to use a number of important software packages.

### LCD screen

The screen hinges down over the keyboard and is held secure by two red latches. It can be folded back and held



# LATEST SOFTWARE AVAILABLE IN N.Z. OR DIRECT OVERSEAS MAIL ORDER

| COMMODORE C64 |                        |          | SPECTRUM   |              |          | AMSTRAD     |                            |          | C 64/PLUS 4 |                       |          |
|---------------|------------------------|----------|------------|--------------|----------|-------------|----------------------------|----------|-------------|-----------------------|----------|
| REFERENCE     | TITLE                  | T/D NZ\$ | REFERENCE  | TITLE        | T/D NZ\$ | REFERENCE   | TITLE                      | T/D NZ\$ | REFERENCE   | TITLE                 | T/D NZ\$ |
| CMICROPR95    | Acrojet                | D 55.95  | REFERENCE  | TITLE        | T/D NZ\$ | REFERENCE   | TITLE                      | T/D NZ\$ | REFERENCE   | TITLE                 | T/D NZ\$ |
| CMASERT75     | Action Biker           | T 14.95  | SMASERT55  | Action Biker | T 14.95  | RMICROGE65  | 3 weeks in Paradise        | I 45.75  | PAUDIDGE15  | 3D Glooper            | T 31.95  |
| CPROBE25      | Adv. Of Basidon Bond   | T 45.95  | SELITE25   | Airwolf      | T 33.95  | RMSOF45     | 3D Grand Prix              | I 39.95  | PCOMMOD015  | Ace                   | T 24.95  |
| CELITE5       | Airwolf                | T 35.45  | THOR15     | Arc od Yesoo | I 41.20  | RAMSOF55    | 3D Grand Prix              | D 59.95  | PAMERGA75   | Asylum                | T 40.50  |
| GAMERICAS35   | Asylum                 | T 40.65  | STRAINBR15 | Art Studio   | T 49.50  | RELITE85    | Artist                     | D 59.95  | WMASERT25   | BMX Racers            | T 24.95  |
| GAMERICAS35   | Asylum                 | T 40.65  | STHORNEM55 | Astronome 2  | I 59.60  | RC.C.S25    | Arnhem                     | T 47.95  | PADESS15    | Beachhead             | I 41.20  |
| CMASERT75     | BMX Racers             | D 49.50  | SC.P.S.14  | Shewson55    | T 36.60  | RACVI24     | B. McGuigans Boxing        | T 39.95  | PBLUDGE15   | Beacomando            | T 37.65  |
| CELECTR165    | Back To The Future     | T 48.20  | SMICROSP75 | SMASERT35    | T 14.95  | RACVI335    | B. McGuigans Boxing        | D 48.75  | POCEAN15    | B.F. Star Events      | T 24.95  |
| CMIROR85      | Biggles                | T 45.75  | SELECTR115 | SMICROSP75   | T 36.20  | ROCEAN165   | Batman                     | T 41.20  | PGPERS55    | Flight Simulator 0-15 | T 33.00  |
| CELITE115     | Biggles                | D 59.55  | SOCEAN135  | SMICROSP75   | T 43.95  | RSOLAR15    | Battle Beyond The Stars    | T 40.50  | PSLARS015   | Galaxions             | T 24.95  |
| CELITE120     | BombJack               | T 36.60  | SMIKROGE75 | SMICROSP75   | T 36.60  | RDKTRN055   | Benny Hill's Mad/Chase T   | 34.00    | PCOMMOD465  | Games Designer        | T 46.00  |
| CEACTI195     | BombJack               | D 68.75  | SACCESS45  | SMIKROGE75   | T 45.80  | RELITE115   | BombJack                   | T 45.75  | PANIROG85   | Ghost Town            | T 35.80  |
| CDATAB115     | Borrowed Time          | T 42.95  | SDKTRN055  | SMIKROGE75   | T 42.95  | RELITE120   | BombJack                   | D 68.75  | PGREMLIN15  | Grand Master          | T 29.95  |
| CGREMLIN75    | Boulder Dash II        | T 39.95  | SELITE45   | SACCESS45    | T 39.75  | RSILVERS45  | BombJack                   | T 36.00  | PWARNERB15  | Gremkins              | T 24.95  |
| CGREMLIN75    | Boulder Dash II        | T 39.95  | SMIROR115  | SACCESS45    | T 45.75  | RZISQFT15   | Boulder Dash               | D 49.50  | PGREMLIN15  | Gulwing Falcon        | T 24.95  |
| CMIGINE85     | Boulder                | T 54.00  | SOXFOR25   | SACCESS45    | T 114.80 | RBIQFIE15   | Bounty Bob Strikes Back I  | T 39.95  | PTYNESOF45  | Gunslinger            | T 39.95  |
| CELITE55      | Boulder                | T 54.00  | SELITE45   | SACCESS45    | T 36.60  | RHEEDGE     | Bounty Bob Strikes Back II | D 52.00  | PCOMMOD035  | Harbour Attack        | T 24.95  |
| CELITE95      | Commando               | T 39.95  | SBUBBLEB25 | SACCESS45    | T 18.95  | RMASERT45   | Caves Of Doom              | T 14.95  | PGREMLIN15  | Home Office           | T 29.95  |
| CBALJUL95     | Commando               | D 54.95  | SC.P.S.24  | SACCESS45    | T 39.95  | RDOMARK45   | Codename Matt II           | T 38.00  | PGREMLIN15  | Home Office           | T 29.95  |
| CBALJUL95     | Commando               | D 54.95  | SUSGOLD115 | SACCESS45    | T 39.95  | RC.D.S25    | Colossus Chess 4           | T 47.95  | PAUDIDGE15  | Kactus                | T 31.95  |
| CDURRELL45    | Computer Hits          | T 39.95  | SLUCASF15  | SACCESS45    | T 38.95  | RBEAUJUL35  | Computer Hits              | T 39.95  | PGREMLIN35  | Kung-Fu Kid           | T 35.45  |
| CUSGOLD85     | Computer Hits          | T 39.95  | SPLACAE15  | SACCESS45    | T 36.95  | RBEAUJUL45  | Computer Hits              | D 52.00  | PMASERT35   | Mr Puniverse          | T 14.95  |
| CMICROP105    | Critical Mass          | T 43.95  | SELITE75   | SACCESS45    | T 36.00  | ROCEAN155   | D.T. Super Test            | T 41.95  | PTYNESOF55  | Mount Vesuvius        | T 31.95  |
| CSYDNEY45     | Crusade in Europe      | D 60.00  | SBUIDGE15  | SACCESS45    | T 11.50  | RPROBE45    | Devils Crown               | T 39.95  | PTYNESOF35  | Olympiad              | T 24.95  |
| CELECD/DR15   | Decision In The Desert | D 60.00  | SFIREB115  | SACCESS45    | T 36.60  | RAMSTRAD15  | Electronic Studio          | D 73.95  | PATLAN115   | Panik                 | T 27.40  |
| CMICROP035    | Desert Fox             | D 62.60  | SOURRELL65 | SACCESS45    | T 38.00  | FRIBERID5   | Empire                     | T 45.75  | PGHANNEL15  | Pogo Pete             | T 31.95  |
| CSYDNEY45     | Desert Fox             | D 62.60  | SSYDNE11   | SACCESS45    | T 39.95  | RMEI/HOU55  | Ex/Fist and F/Warrior      | D 82.50  | PGHANNEL15  | Pulsar 7              | T 24.95  |
| CELECD/DR15   | Deux Ex Machina        | T 43.95  | SCASECOM15 | SACCESS45    | T 46.95  | REDGE15     | Fairlight                  | T 51.75  | PRZORSO25   | Raider                | T 30.00  |
| CMICROP035    | Doc. Who/Mines/Terror  | T 43.95  | SMASERT15  | SACCESS45    | T 14.95  | REDIGITAL45 | Fighter Pilot              | D 52.95  | PGREMLIN95  | Reach For The Sky     | T 36.95  |
| CACTV75       | Eldon                  | T 45.95  | SMASERT15  | SACCESS45    | T 32.00  | RMSERT25    | Flags Keepers              | T 14.95  | PCOMMOD035  | Script/Plus           | C 89.95  |
| CACTV115      | Eldon                  | D 60.10  | SHWSON21   | SACCESS45    | T 36.60  | RMIROR25    | First Steps With Mr Men    | D 49.95  | PRZORSO15   | Sea Strike            | T 30.00  |
| CEGLISH25     | Elektra Glide          | T 41.20  | SORPHEUS25 | SACCESS45    | T 40.30  | RMASERT15   | Formula 1 Simulator        | T 14.95  | PBUDGE15    | Sky Hawk              | T 33.00  |
| CEGLISH35     | Elektra Glide          | D 53.95  | SFIREB15   | SACCESS45    | T 54.95  | RELITE75    | Franko Bruns' Boxing       | D 52.00  | PATLAN125   | Space Escort          | T 18.95  |
| CEZIBIRD5     | Empire                 | T 45.75  | SFIREID5   | SACCESS45    | T 45.75  | ROCEAN125   | Frankie Goes/Hollywood     | T 42.95  | PADVENTU15  | Spiderman             | T 24.95  |
| CMIKROGE35    | Empire                 | D 62.25  | SCRL55     | SACCESS45    | T 36.60  | RP.S.S25    | Get Dexter!                | T 43.30  | PC.D.S.15   | Sleve Davis           | T 24.95  |
| CMIKROGE35    | Empire                 | D 62.25  | SBEYOND14  | SACCESS45    | T 49.35  | RINCENT135  | Graphic Adv. Writer        | D 87.40  | PGREMLIN25  | Sword Of Destiny      | T 24.95  |
| CADDICT145    | Everyone's A Wally     | T 49.95  | SMIROR645  | SACCESS45    | T 45.80  | RIMAGINE75  | Green Beret                | T 41.20  | PANCO15     | Thai Boxing           | T 39.95  |
| CMASERT35     | Football Manager       | T 14.95  | SP.S.S.45  | SACCESS45    | T 36.60  | RVORTEX25   | Highway Encounter          | D 52.00  | PMEL/HOU25  | The Wizard & Princess | T 24.95  |
| CHUTCHIN15    | Formula 1 Simulator    | T 59.60  | SBRABIT15  | SACCESS45    | T 36.00  | RVORTEX55   | Highway Encounter          | T 38.00  | PANIROG95   | TomThumb              | T 27.40  |
| CACTV105      | Fourth Protocol        | D 68.95  | SMASERT25  | SACCESS45    | T 14.95  | RIMAGINE85  | Hypersports                | T 39.95  | PCITISOF25  | Torpedo Run           | T 42.00  |
| CPUBLICD15    | Game Maker             | T 24.95  | SFIREB45   | SACCESS45    | T 36.60  | RIMAGINE15  | HyperSports                | D 59.95  | PIMAGINE15  | W.S. Baseball         | T 39.75  |
| CPUBLICD25    | Gazette Feb 1986       | D 24.95  | SODMARK35  | SACCESS45    | T 38.00  | RELECTR85   | Juggernaut                 | T 36.60  | PTYNESOF25  | Winter Olympics       | T 39.75  |
| CPUBLICD35    | Gazette March 86       | D 24.95  | SC.P.S.55  | SACCESS45    | T 39.95  | RC.R.L.55   | Juggernaut                 | T 36.60  |             |                       |          |
| CFIREL25      | Gazette April 86       | D 24.95  | SIMAGINE45 | SACCESS45    | T 42.00  | ROCEAN195   | Knightrider                | T 41.20  |             |                       |          |
| CFIREL25      | Gazette April 86       | D 24.95  | SULTIMAT65 | SACCESS45    | T 47.95  | RMEI/HOU75  | Lord Of The Rings (+BK)    | T 66.50  |             |                       |          |
| CFIREL25      | Gazette April 86       | D 24.95  | SADV/INT15 | SACCESS45    | T 47.95  | RDATABAS45  | Mini Office II             | T 29.95  |             |                       |          |
| CFIREL25      | Gazette April 86       | D 24.95  | SCOLECTR15 | SACCESS45    | T 45.80  | RDATABAS65  | Mini Office II             | D 72.40  |             |                       |          |
| CFIREL25      | Gazette April 86       | D 24.95  | SGILLSOF35 | SACCESS45    | T 62.95  | ROCEAN85    | Movie                      | T 41.20  |             |                       |          |
| CFIREL25      | Gazette April 86       | D 24.95  | SSYSTEM315 | SACCESS45    | T 29.90  | ROCEAN65    | N.O.M.A.D.                 | T 41.20  |             |                       |          |
| CFIREL25      | Gazette April 86       | D 24.95  | SARTIC15   | SACCESS45    | T 38.70  | RGEIMIN55   | Office Master              | T 82.95  |             |                       |          |
| CFIREL25      | Gazette April 86       | D 24.95  | SOCEAN175  | SACCESS45    | T 36.60  | RGEIMIN65   | Office Master              | T 66.95  |             |                       |          |
| CFIREL25      | Gazette April 86       | D 24.95  | SALLIGAT15 | SACCESS45    | T 24.95  | RGEIMIN115  | Office Mate                | T 62.95  |             |                       |          |
| CFIREL25      | Gazette April 86       | D 24.95  | SBUIDGE15  | SACCESS45    | T 14.95  | RCENTR15    | Office Mate                | D 64.95  |             |                       |          |
| CFIREL25      | Gazette April 86       | D 24.95  | SOCEAN165  | SACCESS45    | T 45.95  | RARIOL465   | Panzadrome                 | T 41.20  |             |                       |          |
| CFIREL25      | Gazette April 86       | D 24.95  | SMEL/HOU65 | SACCESS45    | T 49.95  | RARIOL465   | Panzadrome                 | T 41.20  |             |                       |          |
| CFIREL25      | Gazette April 86       | D 24.95  | SQU/SILV35 | SACCESS45    | T 43.30  | RDIS/SOF15  | Ping Pong                  | D 82.50  |             |                       |          |
| CFIREL25      | Gazette April 86       | D 24.95  | SIMAGINE75 | SACCESS45    | T 39.75  | ROCEAN145   | PyraDev                    | D 82.50  |             |                       |          |
| CFIREL25      | Gazette April 86       | D 24.95  | SMEL/HOU95 | SACCESS45    | T 42.95  | RACESS55    | Raid!                      | D 54.00  |             |                       |          |
| CFIREL25      | Gazette April 86       | D 24.95  | SOCEA55    | SACCESS45    | T 36.60  | ROCEAN145   | Rambo                      | T 43.95  |             |                       |          |
| CFIREL25      | Gazette April 86       | D 24.95  | SGEIMIN75  | SACCESS45    | T 69.00  | RADV/SOF45  | Rebel Planet               | T 68.75  |             |                       |          |
| CFIREL25      | Gazette April 86       | D 24.95  | SARIOLAS25 | SACCESS45    | T 36.00  | RLEISURE45  | Scrabble                   | T 39.95  |             |                       |          |
| CFIREL25      | Gazette April 86       | D 24.95  | SIMAGINE85 | SACCESS45    | T 69.00  | RLEISURE55  | Scrabble                   | D 52.00  |             |                       |          |
| CFIREL25      | Gazette April 86       | D 24.95  | SDKTRN045  | SACCESS45    | T 34.00  | RARIOLAS55  | Skyfox                     | T 48.60  |             |                       |          |
| CFIREL25      | Gazette April 86       | D 24.95  | SHWSON85   | SACCESS45    | T 37.85  | RMASERT35   | Souf Of A Robot            | T 14.95  |             |                       |          |
| CFIREL25      | Gazette April 86       | D 24.95  | SOCEA85    | SACCESS45    | T 38.70  | RMIROR45    | Spfire 40                  | D 49.95  |             |                       |          |
| CFIREL25      | Gazette April 86       | D 24.95  | SADV/SOF45 | SACCESS45    | T 45.75  | RVIRGIN35   | Strike Force               | T 41.20  |             |                       |          |
| CFIREL25      | Gazette April 86       | D 24.95  | ROD ARMS25 | SACCESS45    | T 42.95  | RMIROR35    | Strike Force Harrier       | D 54.00  |             |                       |          |
| CFIREL25      | Gazette April 86       | D 24.95  | SALPHABA15 | SACCESS45    | T 36.60  | RMIROR15    | Strike Force Harrier       | T 43.30  |             |                       |          |
| CFIREL25      | Gazette April 86       | D 24.95  | SBUIGYTE   | SACCESS45    | T 18.95  | RMSOF35     | Stunt Rider                | T 43.20  |             |                       |          |
| CFIREL25      | Gazette April 86       | D 24.95  | SMASERT45  | SACCESS45    | T 14.95  | ROCEAN175   | Superbowl                  | T 41.20  |             |                       |          |
| CFIREL25      | Gazette April 86       | D 24.95  | SOURRELL85 | SACCESS45    | T 38.00  | RBEYOND65   | Superman                   | T 39.95  |             |                       |          |
| CFIREL25      | Gazette April 86       | D 24.95  | SMIROR105  | SACCESS45    | T 36.60  | RGARGOYL35  | Sweevo's World             | T 45.80  |             |                       |          |
| CFIREL25      | Gazette April 86       | D 24.95  | SMARTECH55 | SACCESS45    | T 42.95  | RGARGOYL55  | Sweevo's World             | D 53.25  |             |                       |          |
| CFIREL25      | Gazette April 86       | D 24.95  | SALLIGAT25 | SACCESS45    | T 39.00  | RMSOFT15    | Tank Commander             | T 48.00  |             |                       |          |
| CFIREL25      | Gazette April 86       | D 24.95  | SMIKROGE15 | SACCESS45    | T 39.95  | RTASMAN15   | Tasword 464                | T 54.95  |             |                       |          |
| CFIREL25      | Gazette April 86       | D 24.95  | SEL/ART45  | SACCESS45    | T 45.60  | RTASMAN35   | Tasword 6128               | D 99.95  |             |                       |          |
| CFIREL25      | Gazette April 86       | D 24.95  | SSTBRIDE15 | SACCESS45    | T 41.20  | RC.R.L.85   | Tau Ceti                   | D 54.00  |             |                       |          |
| CFIREL25      | Gazette April 86       | D 24.95  | SBEYOND75  | SACCESS45    | T 34.95  | RC.R.L.     | Tau Ceti                   | T 45.75  |             |                       |          |
| CFIREL25      | Gazette April 86       | D 24.95  | STASKET45  | SACCESS45    | T 36.60  | RPS25       | Theatre Europe             | T 45.75  |             |                       |          |
| CFIREL25      | Gazette April 86       | D 24.95  | SMIROR85   | SACCESS45    | T 36.60  | RP.S.S45    | Theatre Europe             | D 49.95  |             |                       |          |
| CFIREL25      | Gazette April 86       | D 24.95  | SQU/SILV45 | SACCESS45    | T 34.95  | RULTIMAT45  | They Sold A Million II     | T 45.75  |             |                       |          |
| CFIREL25      | Gazette April 86       | D 24.95  | SOCEAN125  | SACCESS45    | T 45.95  | RULTIMAT55  | They Sold A Million II     | D 68.75  |             |                       |          |
| CFIREL25      | Gazette April 86       | D 24.95  | SBEYOND24  | SACCESS45    | T 39.95  | RMEI/HOU65  | Way Of Exploding Fist      | T 39.95  |             |                       |          |
| CFIREL25      | Gazette April 86       | D 24.95  | SGARGOYL45 | SACCESS45    | T 38.95  | RGREMLIN25  | Way Of The Tiger           | D 54.95  |             |                       |          |
| CFIREL25      | Gazette April 86       | D 24.95  | SPSS25     | SACCESS45    | T 49.35  | RALLIGAT35  | Who Dares Wins I           | D 49.95  |             |                       |          |
| CFIREL25      | Gazette April 86       | D 24.95  | STASMAN25  | SACCESS45    | T 45.55  | RELECTR145  | Winter Sports              | T 41.20  |             |                       |          |
| CFIREL25      | Gazette April 86       | D 24.95  | STASMAN35  | SACCESS45    | T 25.30  | RELECTR155  | Winter Sports              | D 54.75  |             |                       |          |
| CFIREL25      | Gazette April 86       | D 24.95  | STASMAN15  | SACCESS45    | T 75.95  | RIMAGINE65  | Yie Ar Kung Fu             | T 38.00  |             |                       |          |
| CFIREL25      | Gazette April 86       | D 24.95  | SC.R.L.45  | SACCESS45    | T 42.50  | RIMAGINE55  | Yie Ar Kung Fu             | D 60.00  |             |                       |          |
| CFIREL25      | Gazette April 86       | D 24.95  | SARGUS15   | SACCESS45    | T 45.95  |             |                            |          |             |                       |          |
| CFIREL25      | Gazette April 86       | D 24.95  | SMARTECH85 | SACCESS45    | T 45.75  |             |                            |          |             |                       |          |
| CFIREL25      | Gazette April 86       | D 24.95  | SULTIMAT95 | SACCESS45    | T 45.75  |             |                            |          |             |                       |          |
| CFIREL25      | Gazette April 86       | D 24.95  | SARIGAS85  | SACCESS45    | T 39.75  |             |                            |          |             |                       |          |
| CFIREL25      | Gazette April 86       | D 24.95  | SMIKROGE65 | SACCESS45    | T 47.95  |             |                            |          |             |                       |          |
| CFIREL2       |                        |          |            |              |          |             |                            |          |             |                       |          |



in position up to an 180 degrees tilt. The screen measures 23 x 10 cm and has a maximum resolution of 640 x 200 pixels.

Although the LCD display is not backlit, it is quite readable with suitable lighting.

There is no auto screen powering off feature – not essential but a useful power saving feature.

However, back in the office I would use an external monitor to process my results and Toshiba offer a colour monitor at a good price when purchased with the T1100.

### System test

Powering on with a full memory check and loading in DOS takes about 30 seconds with a 512K memory.

The system test utility program included on the DOS disc checks the system, memory, character sets and attributes, display modes, disc and printer (if attached).

I would find this very useful if I was in trouble, and a long way from home.

The documentation, as mentioned, is the standard kind of documentation for DOS.

It's a pity no-one has yet documented clearly the DOS commands one needs to know at the start of owning a computer. Plenty of examples are needed for first time users.

Maybe I'll get around to doing that for all those who suffer DOS for the first time.

The 3.5 inch drive holds the standard 3.5 inch disks which can be formatted double-sided with 720K. To do so though requires the format command `FORMAT /3` for an 80 track format – not easy to dig out of the documentation for first time users!

A yellow light on the keyboard and a red light on the side of the drive light up when the drive is working.

### LCD upgrade

Silicon Technologies in El Sobrante, California, claims to be able to upgrade all laptop LCD screens to electroluminescent (ELD) displays.

Because ELD displays are AC (alternate current) devices, power supply "inverters" are added on – the US cost of upgrades stawring at about US\$200 per unit.

### Musical sponsor

AWA Computers has given Auckland's Mercury Theatre \$30,000 for production of a the musical West Side Story, and an additional \$30,000 for promoting the show.

## Microcomputer summary

**Name:** Toshiba T1100

**Processors:** CMOS 80C88, 82C37 DMA controller, 82C53 timer, 82C59 interrupt controller.

**Memory:** 256 KB standard  
256 KB on expansion card (option)

**Peripheral interfaces:** Color graphics, RGB 9 pin D, monochrome composite, Parallel printer, SEcond FDD port.  
**Display:** 640x200 pixels, 80 characters x 25 lines, 9.1x4.2 inches. Aspect ratio: 1.4. Position adjustable 0° to 180°

**Keyboard:** 83 keys, mechanical contact switches

**Floppy disk drive:** Integrated: 640/720 KB capacity. Optional external FDD (3.5 or 5.25")

**Dimensions (WxHxD):** 31.1x6.6x30.5 cm

**Weight:** 4.1 kg (9 lbs)

256K System, Manuals, Power Supply \$3720

Accessories: 3.5 inch disc drive (battery operated) \$ 999, 5.25 inch disk drive \$ 999, RS232 card and cable 280, 256K additional memory \$ 625, power supply (18V) \$ 55, carry bag \$ 50, monitors – colour & composite mono \$ POA.

Distribution/agents: Fairbairn Wright Ltd, Auckland.

### Compatibility

The T1100 is definitely PC compatible and the only problems will come with software that uses the IBM PC version of `BASRUN.EXE` or `BASICA`.

Use the MS-DOS versions of both and you'll be OK. Note that software must not be configured for the Hercules Hi-Res Mono Card.

All of your software can be copied on to the 3.5 inch disks provided you buy either the 5.25 inch drive or an RS232 interface to connect between your PC and the T1100. For novices, I suggest the drive – pushing files through the RS232 is full of traps for first-time users.

If you want to use Lotus, DBase III or other software that is protected by physical damage you'll need to get a 3.5 inch version of the software or the 5.25 inch drive accessory.

Sidekick, Flight Simulator and Lotus 1-2-3 all run perfectly well on the T1100, which gives a good idea of its compatibility.

Benchmarks show that disc access is a little slower than the PC but not enough to be concerned.

### Add-ons

Peripherals include the memory upgrade to 512K, an RS232 card, the 5.25 and 3.5 inch disk drives (the 3.5 inch is battery driven), a carry bag and colour and composite monitors.

The latest Toshiba '3 in 1' letter quality

printers run like a dream off the T1100.

The RS232 card would be essential if you need direct data transfer from a PC or if you plan on using a modem.

### Conclusion

Overall, the T1100 is an efficient, well designed and compact little computer with the full features of a PC compatible – and the screen is reasonably readable. It is well priced and genuinely a laptop. I liked it for its clean, well thoughtout design and its PC compatibility.

I would score it 5/5 for an excellent implementation of an industry standard laptop computer.

### Export HQ in NZ

British manufacturer Bishopsgate, which has supplied the NZ Post Office with its VTX-One Prestel-ASCII videotex terminals, has decided to establish its export headquarters in Wellington.

The Asia and Pacific regions are considered prime growth areas for videotex systems.

### Takeover attempt

Shareholders of the Sperry Corporation in the US have been advised by the company's directors not to sell to Burroughs, and instead have been offered the option, if necessary, of a cash buy-back of their shares by Sperry.



# QUME

Quite simply, more for less



## QUME ALPHANUMERIC TERMINALS

By direct emulation of the features of most leading brands of terminals, the Qume meets market requirements for conversational terminals or as part of a multi-user microcomputer system. In addition to direct emulation the **Qume terminals provide many extras as standard features** such as editing keys, user-programmable functions, and memory.

Models immediately available:

QVT 101 emulation Televideo 910  
QVT 103 emulation VT 100/, VT 131/  
QVT 108 emulation Televideo 912, 920, 925,  
QVT 109 Adds Viewpoint

Plus the QVT 211 and 311 mono-chrome graphics terminals, and the QVT 511 colour graphics terminal which meet every need of engineering and business professionals at most attractive prices.

**STC DATA PRODUCTS (NEW ZEALAND) LIMITED**  
AUCKLAND PH 500-019, WELLINGTON PH 857-985  
P O Box 26-064 Auckland, P O Box 40-140 Wellington

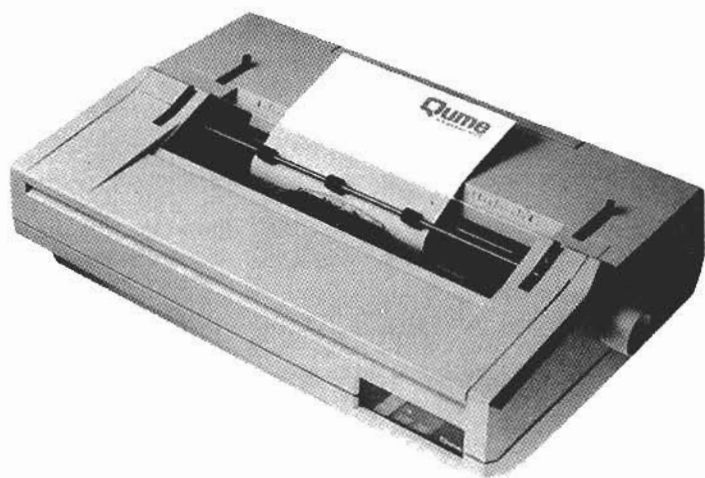

## SPRINT LETTER QUALITY PRINTERS

A range of daisy-wheel printers. 22cps, 40cps, 55cps – up to the amazingly fast SPRINT 11/90 90cps. **You can't buy a faster daisy-wheel printer.** Designed for business applications, Qume Sprint daisy-wheel printers offer a full range of paper handling systems and carriages up to 22". Qume printers will stand up to the pressure.

**Qume**<sup>®</sup>  
A Subsidiary of **ITT**

Printers & Terminals

**Quite simply, more for less**

The best ideas are the ideas that help people. **ITT**



# Soft-Tech pieces it together

Our software awards winner, Soft-tech, is now a thriving company of software developers with a product causing a stir.

But its beginnings were hardly inspiring – two young programmers on their own with a programming contract others had put down as near-impossible to complete.

But three years later David Price and Rex Doran were negotiating further sales of "the impossible", and this year their fledgling company struck gold again in winning our NZ Personal Computer Software Awards contest – which is sponsored by Bits and Bytes, NZ Post Office, and NZ Advanced Technology Trust.

Here is Soft-Tech's story:

Soft-Tech began four years ago with two guys working from home (probably should have been from the garage!) – David Price and Rex Doran, two young and ambitious programmers, hungry for a challenge.

The challenge came from one of their early clients, Hamilton Joinery Ltd, which needed to cost windows and doors on their computer and have scale drawings on the screen so they knew what they were costing.

Hamilton Joinery got their system, all "hard coded". David and Rex then started developing a "full database" version to sell as a package to other manufacturers.

## Sponsorship

Late in 1984 AHI Aluminium Franchising Co commissioned John Ball, a systems consultant, to investigate software packages available for their industry – the results to be presented at a series of conferences scheduled for early 1985.

Early in the investigations it became obvious that no system was comprehensive enough to recommend, but that the Soft-Tech system did show promise.

On this recommendation AHI adopted the Soft-Tech system, offering to bulk buy and to provide their own installation and support.

In exchange Soft-Tech were required to bring the system up to AHI's requirements, and to this end AHI's technical manager Chris Hopper became involved.

The result was a full database system, with costings, and bar and glass cutting specifications, tailored to the aluminium industry's needs. It was well received at the conferences, and 25 systems were sold to AHI franchisees.

Soft-Tech now had a strong user base and credibility in the marketplace.

As the users came on stream so the feedback started, and a period of rapid development followed.

Much of the screen handling was writ-

ten across to assembly language to speed the response time. (The system was developed in compiled Basic).

A quoting module was then released, allowing users to accumulate a houselot of joinery for quoting and economic cutting. A raking-frames module provided costing and cutting of non-90° angles. And a standard configuration module allowed them to draw and cost 3-dimensional units, such as bay windows and the popular greenhouse windows and conservatories.

Inevitably there were teething problems. On several occasions such rapid development led to significant bugs being discovered. But during this period also some excellent management systems were established.

Software Performance Reports (SPRs) were supplied to users. These gathered information on problems encountered and suggested improvements. The reports were reviewed by a committee with representation from both Soft-Tech and the users. Their recommendations formed the basis of future modifications to the system.

## Marketing

The package could now be offered as a total solution to the costing and cutting aspects of the aluminium industry. A marketing policy was established, based on:

- The system being offered only on a WANG PC. The Wang was chosen because of its excellent performance and graphics capabilities. Restricting the market to one machine, and one version of the software, has made development and support far more effective.
- A data loading service being established. For a one-time fee of \$1000 the customer can have a "turn key" operation, complete with one day's training.
- Training courses to run regularly at the main centres. Both 'Operator' and 'Database' courses are available.

Marketing was handled by Office Resource Centre Ltd, the largest WANG PC dealer in NZ. ORC organised direct mail drops with telephone follow-up. Demonstrations at the customers' premises were organised as required.

Early this year the product was introduced to Australia. Distributors have been established in Sydney and Melbourne, using the same marketing and pricing policy.

There was initially scepticism amongst the Australians because credible software developers had previously attempted to tackle such computing problems – resulting in some expensive disasters.

But once they had tested the Kiwi version, their scepticism turned to enthusiasm.

To date nine Australian companies have bought the Soft-Tech system.

So what makes this product special?

First is speed. The operator can cost up a houselot of joinery in less than a third of the time it takes to do it manually. A full range of factory reports to produce the units is then instantly available – in itself a major task for most joinery factories.

Second is simplicity. The costing and cutting calculations require skill and practice when done manually, but the computer can tackle these tasks at the hands of a person with little or no industry knowledge.

Third is flexibility. Being a 'full database' system, the program used by a small domestic manufacturer in a provincial town in NZ is exactly the same as that used by a large commercial manufacturer in Sydney. And both companies can add new products without needing a programmer.

## The future

Soft-Tech is committed to staying the market leader in joinery software development.

Within the next few months a factory scheduling module will be released, and later this year the system will be linked directly to digital saws – the software will calculate economic cuts and also set the stops and angles of the saws.

Soft-Tech is also investigating other potential markets requiring multi-dimensional costing systems, with graphics. Several negotiations are currently under way in areas such as the manufacture of reinforcing steel, security screens, timber joinery and office partitioning.



# The micro and living graphics

by Pip Forer

Teachers have long sought to provide effective visual material for students.

Video is a powerful medium for this and one that can embrace both animation and sound. It is however an unresponsive medium, in that normally there is little choice in how any specific user sees a video clip and very little interaction with it.

Teachers have also searched for tools which allow them to offer a customised learning resource to students, i.e. a resource where support and guidance would be tailored to the individual needs and response of the user. Microcomputers offer some possibilities in this area, but are restricted to the kinds of text and graphics material that can be displayed.

## Interactive potential

It has always been on the cards that someone would put the two technologies together as Interactive Video (IV), thus giving the video intelli-

gence and the computer real-life imagery.

For some six years this has been possible, starting way back with the Apple II and videotape. The potential of such a development seems quite considerable.

The pitfalls however are also there, and so far have slowed progress. Where has Britain reached with IV in 1986?

I started seeking the answer at a session on interactive video at a conference on computers in higher education. Three things became apparent quite quickly:

- video tape was out
- intelligent tutors are still fairly dumb and
- quite a lot of IV was going on in, but not of, education

The last point deserves some clarification. IV is a new star which has caught the eye of the one area of education in the UK still with access to development money: the business training sector.

Training, as opposed to education, generally involves simpler teaching

tasks with much clearer concepts and 'right' and 'wrong' answers. Such tasks so far have been adequately handled by some of the existing authoring languages.

Business trainers have gone for an enhancement: the use of Interactive Video. Educationalists have got involved both to research issues in development of learning systems and to work on areas of their own disciplines where the 'training' component is strong.

## Why IV?

Why IV? Because it offers the learner real-world images in which tone of voice, body language or environmental appreciation can be communicated and form part of the learning experience. For many personnel skills and applied technical skills this is a significant dimension, especially when combined with helpful guidance from the microcomputer.

Some said too hard.  
Others said impossible.  
Soft-Tech won an  
award for it.

For putting people ahead of computers and perfecting a software package of real benefit to the joinery and building industries, Soft-Tech win the 1986 N.Z. Personal Computer Software Award — and our congratulations.

**WANG**

**We put people in front of computers.**



# TOSHIBA T1100

## Portable Personal Computer.

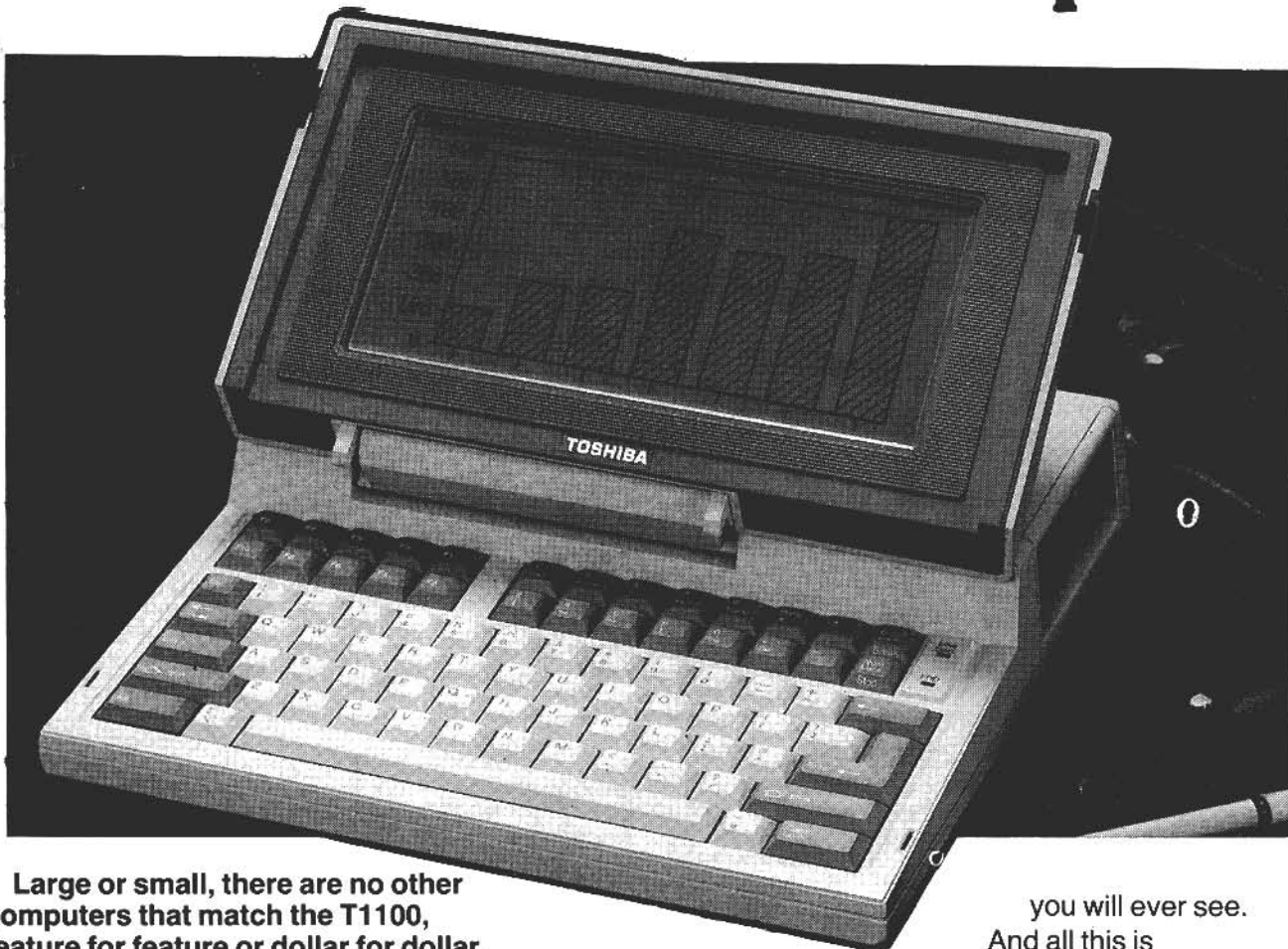

Large or small, there are no other computers that match the T1100, feature for feature or dollar for dollar.

So small, it'll virtually fit in a briefcase, yet the T1100 gives you all the features of a powerful desk-top machine for easy, handy efficient operation.

The T1100 is packed with features that put bulky desktop machines to shame. Weighing in at only 4.1kg, the T1100 comes standard with 256KByte of RAM, an inbuilt 720KByte 3.5 inch floppy disk drive, ports for printers, extension FDD, monochrome and colour monitors.

The T1100 has a full IBM PC fullstroke keyset and a 640 by 200 pixel liquid crystal display that will look up at you from any angle. The lot is packaged in the smartest 31.1 x 6.6 x 30.5 cm case

you will ever see.

And all this is

available for a full eight hours running on rechargeable batteries.

There is a range of accessories to enable the computer to grow for any application. Additional 5.25 in or 3.5 inch FDD's, 256KByte memory expansion, RS232 interface, Monochrome and colour monitors.

Regardless of your application, desktop computing or portable, you owe it to yourself to look at the Toshiba T1100. It's the computer that can make room for itself in your life.

Toshiba technology, one less thing to go wrong.

Available now from  
**FAIRBAIRN WRIGHT LTD**  
**TOSHIBA**

Contact us now for details about the T1100 or any Toshiba computer or printer products.

**Auckland**  
59-63 Main Highway  
Ph 597-162  
Telex NZ60295  
PO Box 11-096

**WELLINGTON**  
11 Raroa Rd  
Ph 692-019  
PO Box 44-112

**CHRISTCHURCH**  
135-139 Ferry Rd  
Ph 69-589

MS-DOS is a Trademark of Microsoft Corporation  
IBM-PC is a Trademark of International Business  
Machines Corporation



## UK Report No. 2

What has happened to Videotape? As an interactive medium it is showing its limitations. Videotape is easy to produce and cheap but the videotape player suffers from the time it can take to reach a given piece of imagery. This severely constrained IV until video disk emerged.

### 'A project combining computers and video'

Disks offer access to any image within a second and can hold a totally stable still-frame display (so a disk can contain tens of thousands of still shots as well as animated sequences and computer generated annotation can be superimposed onto a visual image effectively without judder or interference).

Disks' current disadvantage is their need to be 'mastered' permanently, a process which makes the disk inflexible and costing perhaps \$5,000 a master.

In practice this disadvantage has not deterred big business. The sum is often small compared to the costs of producing the video material itself and it is minuscule compared to some training budgets (the Coal Board's annual training bill alone is over \$150 million a year). The benefits of video disk have however proved extremely attractive.

## Artificial intelligence

All of this has greatly enhanced what interactive video can achieve. The disappointing aspect has been the progress towards an intelligent tutor to drive it. The dream of a combination of hardware and software so sensitive to the user that the average punter would seek guidance and insights from it as easily (or more so) than from a traditional teacher is still a long way from realisation.

In fact the dream was created by the academic hopes of researchers and the economic and administrative hopes of manufacturers and educational bureaucracies.

In the last few years progress to produce this intelligent tutor has been slow.

The great optimism that artificial intelligence concepts would provide a new dimension of flexibility in the near future has largely evaporated.

In the United Kingdom the vaunted Prolog in Education project has suffered reversals (including the much-publicised resignation of Richard Ennals, who has toured New Zealand twice promoting Prolog).

Even the Defence funded developments on display seemed limited. One Lisp based project deserves mention. It was a system to teach the Highway Code to the Royal Air Force.

Asked why the RAF wanted a Highway Code trainer, it was revealed that

their actual need was to teach the 'rules of engagement' (the rules governing when you attack unknown aircraft).

However the rules of engagement were too secret to let the programmers work on, and the Highway Code was considered to be a suitable substitute.

In part this retreat from early dreams represents a more sober appreciation of how hard it is to model an appropriate conversation for learning. However this has not proved too distressing for IV. The original authoring languages designed to permit teacher's to construct a teaching dialogue may have proved largely unattractive because of their reliance on dull text or time-consuming computer graphics, but some are proving quite adequate for authoring IV sessions for training.

## Ingredients

What does an IV session require? Firstly you need the system.

A typical one has three parts: a microcomputer (almost any respectable flavour will do), a video player (usually industrial standard to get the right interfaces) and tutoring/control software (to mediate between the user and the images).

Such systems have been around quite a long time based on video-tapes. Christchurch Polytechnic have developed such a system and Massey University's Business Studies use them extensively.

Then you need a video-disk with suitable material. Let's take a look at one of a series put out by British Telecom on 'Using the Telephone'. This series includes 'Using a Push-Button Phone', 'Making a Sale by Phone' and the inviting 'Innovative Use of the Telephone'. Our unit is 'Handling Difficult Callers'.

The unit commences with a few text screens making sure that we know how the micro works (you do know where the RETURN key is don't you?)

Then suddenly we see an attractive secretary (in fact the beautiful Eurasian from Tenko) dealing with a sequence of abusive or incompetent telephone calls from a variety of callers, most of whom appear to be mates of Arthur Daley.

This unit, we are told, helps you develop skills in handling awkward calls, like from Arthur's mates. Some principles for successful management of awkward callers are explained (including: use the caller's name, show sympathy, keep detached, although not the well-tried one of pretending you are an answering machine).

Then using split screen techniques we get to see Christina Cambell again, now dealing with Mr Bluster. This time she is much more effective. 'How do you rate her performance out of Ten' we are asked (I give a six and am chided as

hard). 'What techniques did she use effectively?' (a menu is provided for us to tick... I miss one and am rehearsed, both textually and with a re-run of the relevant video sequence).

The full unit lasts 30-45 minutes. At the end what we do have? British Telecom hope to have someone with positive attitudes to the phone. Commerce hopes to have a more effective receptionist. The users hope to have insights into skills they didn't have before... and more interestingly also gain insights into how others are manipulating them (I am sure my behaviour both as called and caller has altered).

The cost is not cheap, but given the large number of potential trainees the cost per head is pretty attractive - if it works. The evidence suggests that for many areas of training it works very well.

This unit, and the others I saw, certainly made an impact on me.

Their actual tutoring capabilities in terms of programming are fairly naive, but their success comes from the empathy, communication and impact that the video component can provide when combined with some fairly elementary guidance (which is pitched some way back from the forefront of intelligent tutoring).

## IV in Education

To assist the introduction of IV in training, UK industry and government have jointly sponsored a National Interactive Video Centre (NIVC) in London which co-ordinates studies and encourages developments.

The production and design of training units has become a significant industry in itself. There is too an educational component.

NIVC have sponsored six projects to explore the use of IV in schools. Two of these are related to geography and the environment, where of course the video component has great potential for displaying landscapes, environmental processes and human activity.

Another is in French, where you will get to wander around a village (using your videodisk and a mouse) as you attempt to purchase the ingredients for a picnic. I am told that the prices of goods will vary from shop to shop, as will the availability of certain choice vintages and cheeses. Only nine out of ten if you miss the special on Mouton Cadet '79 down at the corner cellar.

These projects have just begun and will be complete towards the end of 1987. They are only the beginning of what IV can offer.

There is already a project which goes much further in combining computers and video and is due for release late this year. This is the Domesday project. More news of it in a couple of months.



# AS NOT SEEN ON TV!

## YOU DON'T PAY FOR ANY FANCY OVERHEADS!

This is it! The truly IBM software compatible that's affordable enough for small business and personal users. Backed with an exciting range of software for any application: compatible with virtually all IBM software! With the all new DSE Multitech a whole new world has been opened to the computer user. Multitech gives you the choice — the best choice for a system that can be as powerful and versatile as you need! Start with a system which offers more power and better value than anything else around, a system the family can play with and you can put to work! And when you need it — it will expand to give your performance you'd never dream of at the price.

### SYSTEM 1

This is the low cost entry level version. It comes complete with 360K floppy disk drive, 128K of RAM, MS-DOS version 2.11 and three months warranty. Cat X-8000

**\$1995**

### SYSTEM 2

With this system we start to get serious. Two 360K floppy disk drives, 256K of RAM, MS-DOS 2.11 and three months warranty. Cat X-8001

**\$2495**

### SYSTEM 3

The complete expanded system — 10Mb hard drive (internal), one 360K disk drive, 512K of RAM, MS-DOS 2.11. A range of business software packages is available to suit all of your needs Cat X-8002

**\$3495**

**SAVE \$295**  
ALL SYSTEMS.



The Power/Price Alternative

## DSE Multitech

Now there is a choice in the computer field that offers power, features and performance — at an affordable price! DSE Multitech is ideal for small businesses that need to be competitive, reduce costs and increase efficiency. The list of software application is virtually limitless.

### Now double hard disk storage capacity!

With a massive 20Mb hard disk drive there's virtually no amount of data you can't store on one disk. Just imagine the convenience and time saved... no disk swapping... added efficiency. Together with your Multitech, you have one of the most powerful and yet affordable systems available! Cat X-8020

**\$4795**

### Turn your system one or two into a powerhouse!

If you need more power, greater memory capacity of your Multitech One or Two, a 10Mb hard disk is the ideal way! It's capable of storing nearly all your business data on one disk... brilliant 10 million character storage capacity saves time and trouble. Cat X-8005

**\$2295**

**PLEASE ENQUIRE ABOUT OUR UNBELEIVABLE BULK PURCHASE PRICES**

- AUCKLAND  
Downtown  
Newmarket  
Papatoetoe  
Avondale
- HAMILTON
- WELLINGTON
- LOWER HUTT
- CHRISTCHURCH
- DUNEDIN

Cnr Fort & Commerce Sts, Ph: 38 9974  
98 Carlton Gore Rd, Ph: 54 7744  
26 East Tamaki Rd, Ph: 278 2355  
1795 Great North Rd, Ph: 88 6696  
450 Anglesea St, Ph: 39 4490  
154 Featherstone St, Ph: 73 9858  
440 Cuba St, Alicetown Ph: 66 2022  
Cnr Victoria St & Bealey Ave., Ph: 50 405  
Cnr Manse & Stafford Sts, Ph: 74 1096

Want to know more about the DSE Multitech?  
Send for your FREE information pack.  
It's obligation free.

Name .....

Address .....

..... Phone .....

Drop into any Dick Smith Electronics store or send to:  
DSXpress, Private Bag, Newmarket, Auckland

**Dick Smith Electronics**

# COMPUTER CITY





# Whose BIOS is it anyway?

The war between IBM and the IBM clones is warming up. Both locally and in Taiwan itself IBM is taking steps to prevent other suppliers from marketing PC clones which include IBM's Bios chip.

In Auckland, Computer Imports, who for some time have been selling the Sigma/Exzel brand and gained a significant section of the traditionally IBM market, have weathered the first round of court action.

Their product, to all intents and purposes, is an IBM – some would say without the reliability of IBM. But it is up to 'Big Blue' to convince the court that there has been an infringement of copyright.

If nothing else, these IBM look-alikes that have swamped the NZ market have led to considerable price reductions in the PC market. IBM have two or three times, since September last year, dropped their prices.

What the buyer must do now is to take advantage of this pricing, but purchase a reliable brand.

We can't see PCs getting cheaper.

## PC86

Well, we've had a most interesting time at our first show: Bits & Bytes-organised PC86.

We were the only stand with a "genuine" IBM PC AT, although you could hardly move for clones.

Noticeable for their absence were Apple – come on guy's, we know you've had a hard time lately, but we had a lot of people asking us where you were?

Or was it just that it was a PC show and not a MAC one? Amstrad and Commodore didn't seem to mind.

Commodore released the AMIGA at PC86 – and about time too. We can vouch for the quality of it's sound generation – our stand was next to Commodore's and we had the thing repeating the same tunes over and over.

Certainly it has impressive graphics and sound, and the price is a little better than originally thought – \$3995. Still high for a US\$1295 machine, but better than \$5000.

Thanks to everyone who reads our column and who popped into the stand – it's nice to know you're out there!

And thanks to the folks that contacted us regarding last month's plea for some job costing software for the small tradesman – we've had a number of "hot" leads, and we'll report back when we've had a chance to look at them in more depth.

Big buck promotion at PC86 was Paradox – the new database program from ANSA, which Imagineering were debuting.

It's a very powerful tool, with a Lotus-like, menu driven, interface, and the macro capability.

In fact, one of the job cost programs we'll be looking at has been developed using Paradox.

They're waiting for a runtime version before they release their application, and the rumours are that there's a multi-user version in the pipeline too.

## Training

Our new series of MicroLab training courses attracted a lot of interest, and lots of people took away enrolment forms.

We are offering introductory and advanced courses on spreadsheets, databases, and word processors.

Products covered include Lotus 1-2-3, Supercalc, Wordstar, Multimate and Dbase. We can organise sessions in almost any well known product (like Paradox, or Framework) if you have a special need.

We are also offering advanced courses in PC/MS DOS, networks, and telecommunications.

For those of you that feel a bit daunted by all this high technology, or have a boss who's vowed never to get anywhere near the infernal thing, we've developed a special all day course that explains all the jargon, and introduces the attendees very gently into word processing, spreadsheets, databases and general purpose business accounting software. For further information call Auckland 773-470.

## Reflex

A new Borland product, Reflex Database, is available in New Zealand.

Reflex is designed to be an easy to use database for the smaller business and will run on an IBM PC, XT, AT or compatible with a minimum of 384K memory.

Although the manual is out of date concerning installing the software, a look at the Readme file allows quick installation.

The manual leads the new user through a comprehensive tutorial. Options are selected with pull down windowing or commands.

Function keys are used to scan records, list choices and access the help screens.

*In this regular column we keep the business person in touch with developments in the microcomputer industry.*

*The research reports are from Phil Ashton and Grant Furley at MicroLab, a "neutral" d.p. consultancy established by the accountancy KMG Kendons, in Auckland.*

Reflex also offers a mouse interface.

A major feature is the ability to put information into a spreadsheet-like format for modelling and 'what if' projections, and can be used for break-even analyses or summations.

As well as using windows for menu choices, Reflex also makes good use of them on the data entry and viewing screens.

You can window your screen to show you one file set out as a form, while the other window shows a list of records.

You can jump between them and scan or alter information. A third window could allow you to graph what you are looking at.

Reflex has a useful record selection where you can choose to find all information that fits the criteria or that which doesn't fit.

Sorting can be specified for up to five different sort levels.

While you can list selected information to the printer through the Reflex program, you are required to exit the program and run another one (Reflex2) if you want to set up a formal report, print your graphs or export (or import) information from other programs.

It would have been easier to have been given a start up menu to give the options of Database or Reporting functions. But despite this, Reflex's report writer is very thorough in the options it offers.

The fact that Reflex doesn't work from disk, but instead resides in memory, is definitely a drawback for the program. This means the file is limited by memory size.

The other major drawback was the inability to link files together.

A database where you can have a 'Product' and a 'Transaction' file linked together offers much more versatility than an unlinked database.

Overall I found Reflex extremely easy to use and to learn with some very nice features that some of the larger databases could do with incorporating.

For the smaller business or as a management tool for anyone wanting to do data manipulation, it would have to be worth having a good look at.







# C64 Superscript has mail-merge

by Andrew Mitchell

Super by name and super by performance, and that's no exaggeration. As the name implies this is a word processor and it comes from Precision Software, who also produced Superbase 64.

All the usual commands and facilities are there but there are some extras which, to me, make this package a definite must.

There is a built-in spelling checker which, although a little slow, is acceptable.

However, a better facility is being able to view all the words used in a particular document, in alphabetical order, together with the frequency of use.

In this way if a word is spelt wrong by accident then you are very likely to pick it up faster than the spelling checker.

A statistical breakdown of your document is also given.

If you are producing a document that involves maths tables or accounts, the programme will do the addition down and across the page for you.

You will have already prepared your totals of course, but this facility allows you to check that all the figures have been typed in correctly.

You can also prepare a mailing list as a Superscript file and then produce the letter you wish to send to them all.

By using the Merge command you can then personalise the letter, not only by address but anywhere in the text. This includes a 'conditional' marker which means the Merger will skip over a particular insertion if you wish.

Formatting the page layout is really easy, just one control character, followed by letters and numbers to set the required setting - this, as opposed to the control character for each part of the layout. Right justification can be turned on and off as required.

You can also define each of the keys so that they reproduce a line of text or programme commands (up to 24 characters), at will. This can be set up temporarily for each session or built into a Default file which loads automatically with the programme.

Superscript can also use other sequential files within reason. Of course some control commands from other

programmes will cause problems. I was able to produce a file from one of my Superbase datafiles using the Superbase 'Export' command, load it into Superscript and then print it. A nice touch.

Easyscript files can also be loaded, but as mentioned before the control commands have to be removed before printing.

By the way, if you're a crossword fan then you are able to put in the known letters of a word, with wild cards for the unknown (eg. cr\*s\*w\*rd) and the dictionary will produce all the words that fit that pattern. If you're a real fan, this facility may be worth the price on its own.

The programme also allows for the setting up of a default file which allows for the peculiarities of your own printer. If, for example, your printer supports underlining, then this can be called for. If not, then it can't do the impossible.

Summing-up, I can recommend this package as being a word processor of business proportions at home market prices (\$159.95 for the disc package).

Review package loaned by  
Commodore Computer NZ Ltd.



**BUSINESS OPERATING SOFTWARE**

**Now in New Zealand**

**BOS software gives you true multi-user function even on single user PCs**

(e.g. SANYO • WANG • PC • CANON • IBM • PC/XT)

- ★ BOS has 30% of multi user micro sites in the U.K.
- ★ 10,000 sites in 30 countries
- ★ Ease of use, an untrained person can install a complete system in minutes
- ★ Transportable on over 100 computers, guarantees future expansion

**BUSINESS SOFTWARE**

**OFFICE SOFTWARE**

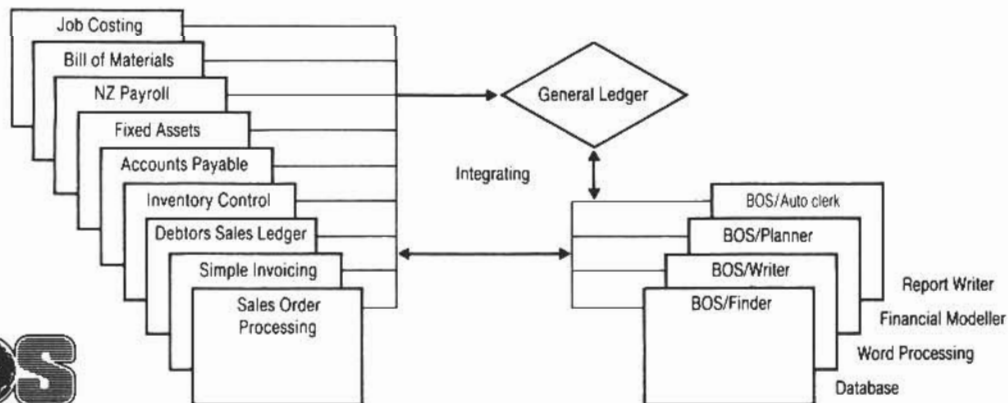

**Software (NZ) Ltd, P.O. Box 221, Auckland. Phone (09) 798-178**



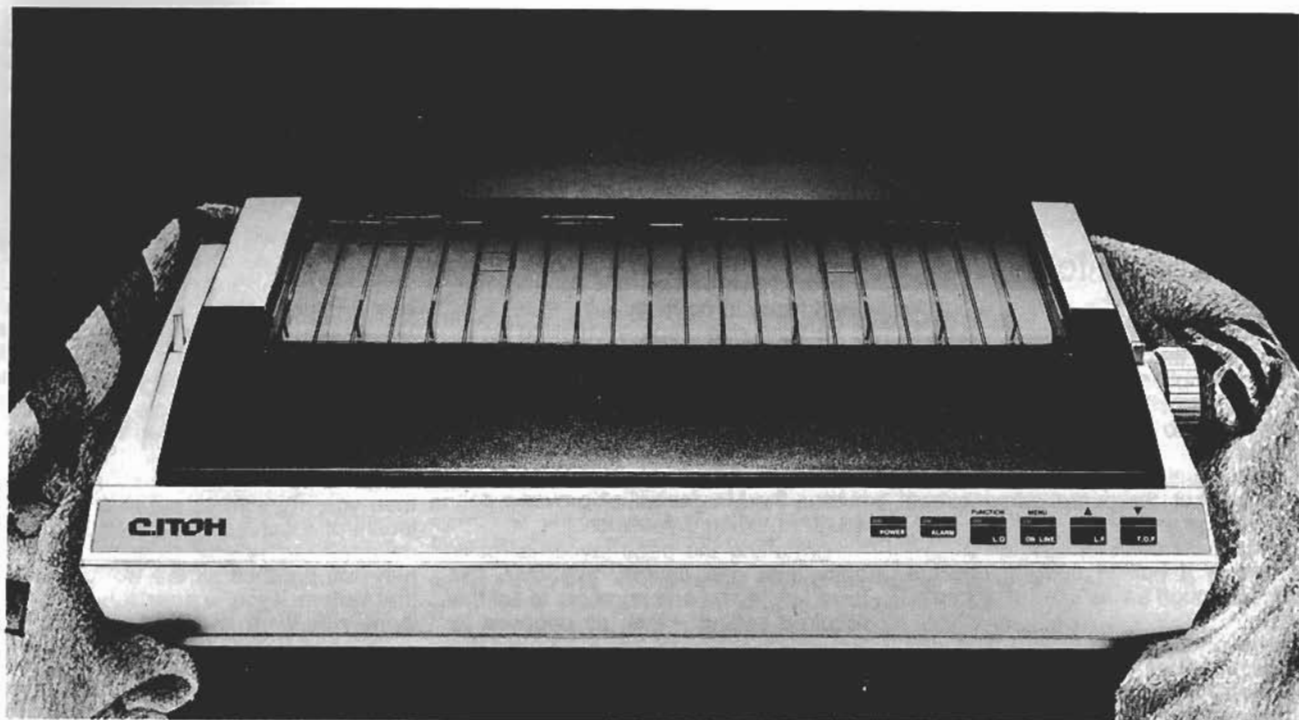

# TRIATHLETE!

Data processing – NLQ – Letter Quality

C.Itoh's new C-315 printer.

Speed, versatility and endurance.

Teamed with your IBM-PC, compatible or minicomputer, the **C-315** prints at a blistering 87 full lines per minute (250cps) in data processing mode. And gives C.Itoh's renowned clear print quality. In near-letter-quality mode it hums along at 50cps. And letter quality mode produces a smart 33cps – all with logic seeking bi-directional printing.

#### Three-way paper feed with autoloading.

1. Bottom feed with pull out tractor.
2. Push in tractor feed allows output to be torn off 1" above the print head – perfect for invoices.
3. Friction feed of letterheads while tractor holds sprocketed paper.

Optional 1 or 2-bin Automatic Sheet Feeders. Set up is by printed menus not DIL switches. And its "quiet level" is only 55dBA.

#### Invest in colour!

C.Itoh's **C-315C**, gives you vivid 7 colour printing for crisp, accurate charts and graphics from 1-2-3, Symphony etc. It costs little more and converts to black and white automatically when the standard ribbon cartridge is used.

#### Compact models too.

The C.Itoh **C-310** with 10" wide paper feed has all the same features for letter size printing. If your business needs an all-round printer with the speed, versatility and endurance to win – put the C.Itoh **C-310** or **C-315** "Triathlete" to the test.

For the name of a dealer near you contact:

## CONTROL

PO BOX 68-474 AUCKLAND, NZ TELEX NZ 61102 'DATASYS'  
45 NORMANBY ROAD, MT EDEN, AUCKLAND 3. PH (09) 600-687.



# **THE 1986 WELLINGTON COMPUTER SHOW**

## **CATALOGUE**



**OVERSEAS PASSENGER TERMINAL**

**Thursday 10th July**

**Friday 11th July**

**Saturday 12th July**



# microbee update:

Microbee Systems NZ are pleased to announce a further addition to our range of 128K computers. The new Premium Series offers all the features of the Standard 128K computer, plus an upgrade in performance and even more features.

For a small increase in cost, the Premium Series offers you a standard Videotex and colour video; greatly

This shows the graphics resolution of the new Premium microbees. It is possible to display 131,072 individually controlled pixels.



enhanced graphics capability; four extra keys for cursor control; improved video circuitry and a volume control for the internal speaker.

These improvements increase the flexibility of a Modular Microbee

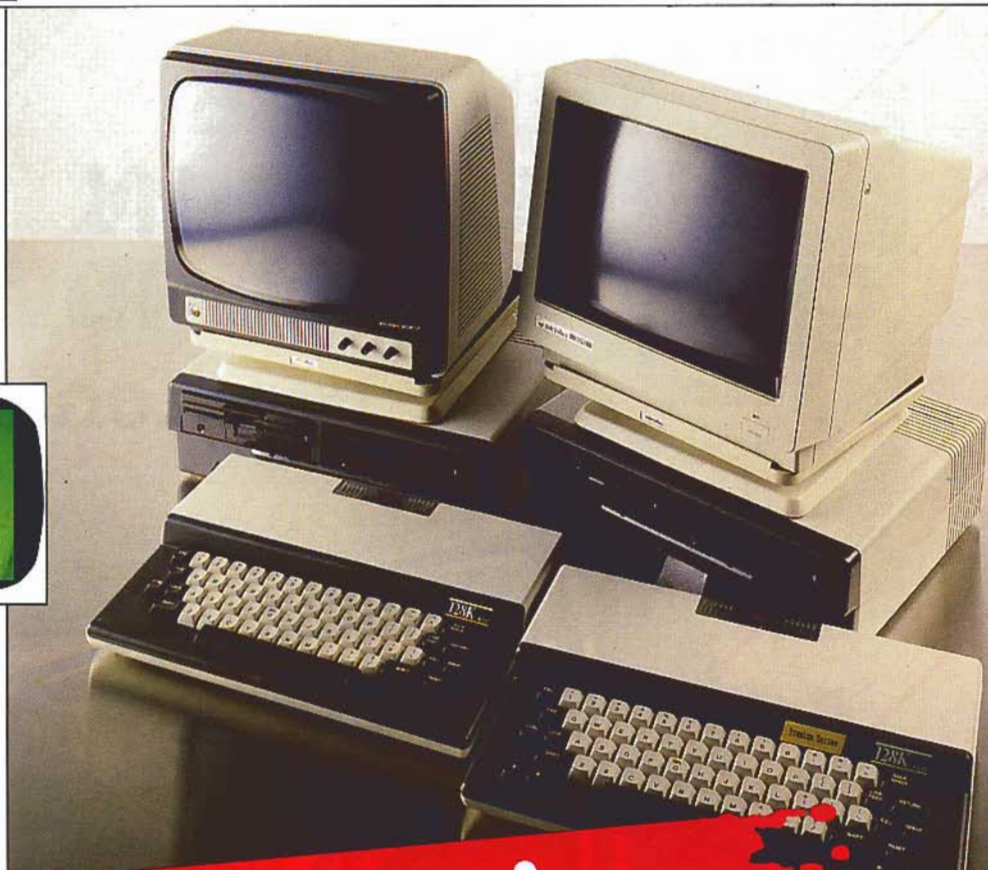

## New Premium version available - all microbees.

computer, by letting you choose the computer that's right for you.

Microbee Systems NZ can also supply a comprehensive software range that includes Aust. Educational Software, world class wordprocessing, as well as Small Business Software especially designed for New Zealand.

Whether it's in the home, school or for business, Microbee offers high performance at a lower cost.



**Microbee Systems NZ Ltd**

438 b Rosebank Road, Avondale, Auckland  
Telephone: (09) 88 1138 or 88 1139.

Wellington: P.O. Box 26 045 Newlands,  
Wellington. Telephone: (04) 78 5548.

### Example: Microbee Modular 128K Computer

#### Standard

The 128K floppy disk based system designed for serious home or business work. With 128K of user RAM memory it is compatible with your choice of 5.25-in or 3.5-in disk drives and comes with an enhanced CP/M operating system and user friendly icon menu shell with Telcom communications programme.

Choose from Microbee's range of monitors, printer, modern and world class software to build the system that suits you. Software available includes Wordstar 3.3 Professional Pack, Microsoft Multiplan, BASIC Turbo Pascal and a vast range of Educational Programs.

#### Premium

The Premium version of the 128K Computer provides all of the features of the standard model.

#### PLUS

- Videotex and colour video inbuilt
- Greatly expanded graphics: 131,072 pixels
- Four extra keys for cursor control
- Upgraded colour and keyboard circuitry
- Sound volume control

\*Standard model above shown with economy monochrome monitor



# Cash registers have just become obsolete!



Meet the new  
**Canon**  
**TX-50 II**  
RETAIL MANAGER

- As compact as a cash register
- Easier to use than a cash register
- Keyboard, integrated printer & cash drawer like a cash register
- Does far more than a cash register

**A unique retail system for sales & inventory management. Based on leading computer technology, with the new, smart, Canon Micro Disk.**

- Simple to use — sophisticated results
- Ready for GST
- Programmed for your business — ready to work now!

Just some of its features . . .

- Automatic inventory control, updating & analysis
- Detailed receipt generations
- Restricted password access to prices & update facilities
- Can integrate with other accounting software
- Can interface with other computers
- Features can be customised to meet your special requirements
- Ultra-user friendly — no special training needed
- Comprehensive sales analysis — including season, last year, payment type
- Security control by key & password
- Programmed keyboard for operator sequences & many automatic functions

Not just a cash register, but by using the unique Canon Micro Disk — a smart retail business manager as well! More information about your business for better management, control & profit!



**SEE US  
ON STAND  
No.1**

*Brand New From . . .*

**Canon** **COMPUTER SYSTEMS**  
*Your business partner*

Canon Data Products 10-14 Como St, Takapuna, PO Box 2191, Auckland Phone (09) 492-176  
Embassy Theatre Building, Marjoribanks St, Wellington, PO Box 9548, Wellington Phone (04) 850-449  
A division of Keridge Odeon Business Equipment Ltd





The world's best promise  
of reliability, from the world's  
biggest seller of floppy disks.

By consistently producing better technology, Verbatim rapidly became the world's biggest seller of floppy disks.

These days, *new* Verbatim disks are so reliable we can confidently warrant they'll last a *lifetime* in constant use.

That's a *human* lifetime, not some vague disk lifetime expectation. Only the world's biggest seller of disks could offer such a warranty.

Exceptional accuracy and reliability is built into every single disk we sell, because every disk is individually tested.

Every Verbatim disk is, therefore, as perfect as a disk can be.

Which is probably why we sell more than any other disk maker in the world.

**Verbatim.**  
Word perfect. For life.



Verbatim.

25/2D-MD 550-01

Double-Sided/Double-Density  
Soft-Sectored With Hub Ring

DataLife

**Verbatim.**  
*DataLife.*

Minidisk



**The 1986 Wellington Computer Show**  
organised by  
**Wellington Shows & Exhibitions Ltd**  
and  
**Bits & Bytes**  
New Zealand's leading computer  
publication

CATALOGUE FOREWARD

It is with pleasure we welcome you to the third annual computer show in Wellington.

When the concept for dedicated computer shows in Auckland, Wellington and Christchurch was first mooted, there were many people in the computer industry who felt these would not be supported; because of our small population they believed there would not be a lot of people interested in specialised shows, as opposed to more general exhibitions.

However, the continued high interest at each of our shows (attendances in excess of 10,000) is clear evidence that the computer industry is alive and well and that interest in the innovative and high tech developments that the industry introduces each year has not waned, as it has in other countries.

In each centre, Bits & Bytes combines with an on-the-spot organiser who is able to bring together an exhibition which is relevant and which caters to the needs in the local environment.

We are fortunate that Mark Heymann has returned from Australia especially to organise the Wellington Show this year. A special feature which Mark has been responsible for is the added dimension of Communications. This rapidly growing aspect of computer activities will be highlighted with a number of specialist exhibitors presenting displays focussing on communications.

As well, a day of seminars on some of the many facets of communications is likely to prove of high interest to those exploring the new advantages this rapidly developing field has to offer.

Our thanks to Mark for his capable participation and best wishes to attendees and exhibitors alike for a successful three days.

Regards,



**Gaie Ellis**  
Managing Director *Bits & Bytes Ltd*

**JENNESS**

**HUTT VALLEY'S  
AMSTRAD SPECIALIST**

*173 High Street,  
Lower Hutt.*

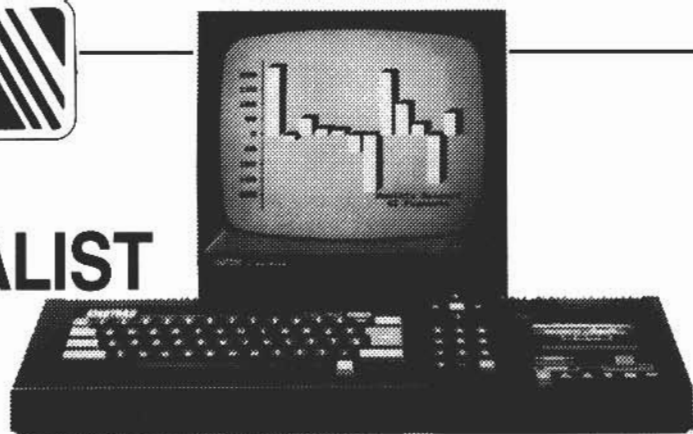



# HOW MANY COMPANIES CAN OFFER YOU ALL THIS?

- |                          |  |                          |   |
|--------------------------|--|--------------------------|---|
| <input type="checkbox"/> | <i>Financial/Banking Systems</i>                             | <input type="checkbox"/> | <i>EFT/POS Terminals</i>                    |
| <input type="checkbox"/> | <i>Business Computers</i>                                    | <input type="checkbox"/> | <i>Microcomputer Systems</i>                |
| <input type="checkbox"/> | <i>Word Processors</i>                                       | <input type="checkbox"/> | <i>Distributed Processing</i>               |
| <input type="checkbox"/> | <i>Printers: Daisy, Dot Matrix and Ink-Jet</i>               | <input type="checkbox"/> | <i>Local and Wide-area Networking</i>       |
| <input type="checkbox"/> | <i>Modems and Multiplexers</i>                               | <input type="checkbox"/> | <i>Teletex and Datex Access</i>             |
| <input type="checkbox"/> | <i>Videotex Terminals</i>                                    | <input type="checkbox"/> | <i>Digital-Optical Mass Archiving</i>       |
| <input type="checkbox"/> | <i>CD-ROM</i>  | <input type="checkbox"/> | <i>Interactive Laser Video Systems</i>      |
| <input type="checkbox"/> | <i>Video Projectors</i>                                      | <input type="checkbox"/> | <i>Dictation Equipment</i>                  |
| <input type="checkbox"/> | <i>PABX's</i>  | <input type="checkbox"/> | <i>Key Systems</i>                          |
| <input type="checkbox"/> | <i>Telephone Terminals</i>                                   | <input type="checkbox"/> | <i>Intercom Systems</i>                     |
| <input type="checkbox"/> | <i>2-Way Mobile and Portable Radio</i>                       | <input type="checkbox"/> | <i>Radio Pagers</i>                         |
| <input type="checkbox"/> | <i>Cellular Mobile Telephones</i>                            | <input type="checkbox"/> | <i>Mobile Digital Communication Systems</i> |
| <input type="checkbox"/> | <i>Comprehensive Training, Software,<br/>Service Support</i> |                          |   |

**PHILIPS — UNIQUELY QUALIFIED TO TALK TO YOU  
ABOUT COMMUNICATION AND AUTOMATION**

**PHILIPS NEW ZEALAND LIMITED  
TELECOMMUNICATION AND DATA SYSTEMS DIVISION**

P.O. Box 2097, Wellington. Tel: 889-210 Data Systems  
Tel: 735-735 Business Communications  
Tel: 683-936 Mobile Radio  
P.O. Box 41-021, Mt Albert, Auckland. Tel: 894-160  
P.O. Box 1488, Christchurch. Tel: 798-030



**Professional  
Systems Group**

# PHILIPS

TC 647



# 1986 WELLINGTON COMPUTER SHOW

## ANDAS BUSINESS MACHINES LTD

P.O. Box 6139  
Wellington  
859-699

**HARDWARE:** Sharp MZ 5600 Business computer, Sharp PC 7000 Compact computer, Facit 9620 "The Typing Station", Juki Printers, Mitsubishi Printers.

**SOFTWARE:** (1) Full range of business control software supplied, free of charge.  
(2) Full range of IBM compatible software.

**PERSONNEL:** Kerry R. Huston, George J. Bright, Anna Geremia.

## BARSON COMPUTERS (NZ) LTD

1 Ngaire Ave  
P.O. Box 26-287  
Epsom, Auck. 3  
(09) 504-049

**HARDWARE:** BBC Master series micro, Apricot microcomputers, Tandon IBM compatibles.

**SOFTWARE:** Various including Xenix.

**PERSONNEL:** G. Briston, G. Magness, J. Joyce, T. Krzyzanski.

## BUSINESSWORLD COMPUTERS (WELLINGTON) LIMITED

11 Johnston Street  
P.O. Box 3351  
Wellington  
731-152

**HARDWARE:** IBM Personal computers and IBM system/36 PCs, IBM range of printers plus Epson, Star and Hewlett Packard. A wide range of components and accessories.

**SOFTWARE:** d Base III plus, Paradox, Framework II, Lotus 1-2-3, Displaywrite 3, Multimate Advantage (latest product), Wordstar 2000 plus CBA and other accounting packages, system and utility software, recreation software, accessories, networking.

**PERSONNEL:** Mike Amer, Paul Gilmore, Chris Macay, Nigel Blair, Greg Harbers, Paul Grealish, Mike Thompson.

## B.P.I. SYSTEMS LTD

P.O. Box 10099  
Wellington  
720-773

## CANON DATA PRODUCTS LTD

P.O. Box 9548  
Wellington  
850-449

**HARDWARE:** Microcomputers, full range of Canon models and full of range of printers. Retail Manager - point of sale system. Laser Beam Printers.

**SOFTWARE:** Full range of accounting and vertical market software.

**PERSONNEL:** Kevin Ennion.

## MALCRON COMPUTER SYSTEMS LTD "Computer World"

42 Manners St.  
Wellington  
720-989, 742-950

**HARDWARE:** Commodore PC, Bondwell PC, Commodore Home Computers, Amstrad Hardware, Hi Speed Printers, Plotters, P.O.S. system.

**SOFTWARE:** PC Software, Commodore Home Software, Graphics, Amiga Software.

**PERSONNEL:** Ronnie Magan, Malcolm Curson, John Algar, Geoff Thomason.

## Exhibition information

Hours: 9.30am-6.30pm daily

Admission: Business Pass \$1  
Adults \$3  
Children \$1

Cafeteria - First Floor  
Seminar Programme -  
Page 48, 49, 50.  
Floor Plan - Page 44.

## Customised CAD for professionals from Computers for People

With so many people talking about the benefits of CAD and different software and hardware options it can be confusing.

Computers for People take a different approach:

How can we put together a CAD system that best meets your individual needs? We can design a customized CAD System based on AutoCAD for NEC, WANG, IBM,

Kaypro or any MS DOS/PC DOS format, with Graphtec or Houston Instruments Peripherals.

Once we've established what you need we install the system and train you and your staff on how to get the best from your CAD system.

Because we offer much more than CAD alone we can integrate your CAD system into an office

management and procedures system that will support the CAD environment. Our in-house programmers can assist with any necessary software development or adaption of existing programmes.

Alternatively, we're always happy to act as consultants and evaluate any CAD system on your behalf.

### SEE COMPUTER-AIDED DESIGN AND DRAUGHTING WITH APPLICATION IN —

- Architecture
- Engineering
- Quantity Schedules
- Tool Design
- Electrical Layouts
- General Draughting



AUTOCAD™

35 Taranaki Street, Wellington  
Phone 859-675



IDEAS 911

# HIGH PERFORMANCE AND STAYING POWER FROM HEWLETT PACKARD

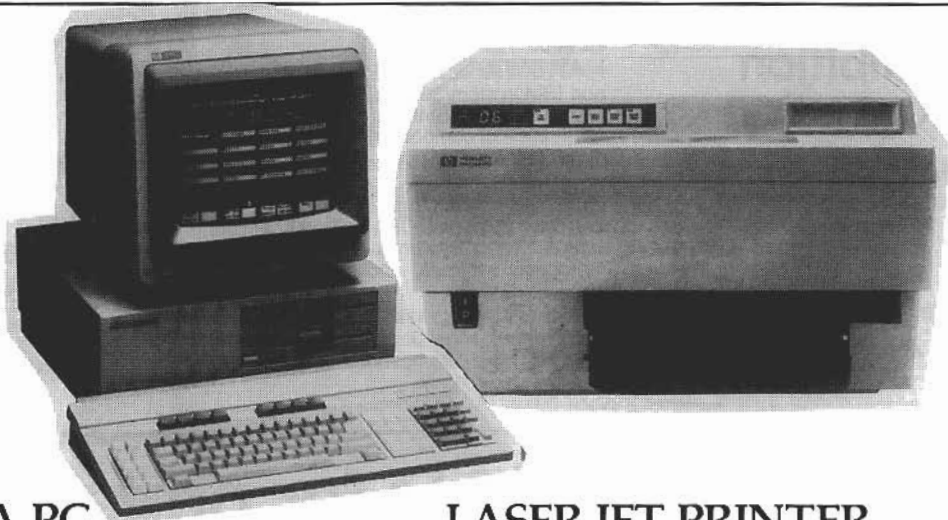

## VECTRA PC

Awarded 1986 Best "Business Hardware Desk Top" in Australia.



Made without compromise for people who won't.

## LASER JET PRINTER

World's Best selling desk top laser printer.

Auckland 5 Owens Rd, Epsom. Ph 687-159  
Wellington 186-190 Willis St. Ph 877-199  
Christchurch 75 Peterborough St. Ph 796-409

For your PC, Printer, Wordprocessor and Office Automation needs for '86 and long beyond — see Hewlett Packard now!

### AUCKLAND

Problex Research Ltd  
246 Hobson St. Ph 775-617  
Calculator Centre Ltd  
27 Lorne St Ph 790-328  
Computer Time Ltd  
Cnr Manukau & Owens Rd, Epsom. Ph 687-165  
Softworks Corporation Ltd  
27 Symonds St. Ph 773-732  
Business World Computers Ltd  
127 Symonds St. Ph 396-521  
Office Information Ltd  
145 Nelson St. Ph 396-226  
Financial Systems Ltd  
161-163 Jerovis Rd, Herne Bay. Ph 789-069  
Office Resource Centre  
T & G Building, Cnr Wellesley & Elliot Sts.  
Ph 794-706  
Power Corp Systems  
Commercial Union House, 12-14 O'Connell St.  
Ph 792-517

### TAURANGA

Office Automation Co.  
321 Cameron Rd. Ph 86-807

### PALMERSTON NORTH

Business World Computers Ltd  
45 Rangitikei St. Ph 79-255

### MASTERTON

Business World Computers Ltd  
AA Building, 89 Chapel St. Ph 80-963

### WELLINGTON

Business World Computers Ltd  
11 Johnston St. Ph 731-152  
Compu-Sales Software & Hardware Ltd  
75 Ghuznee St. Ph 844-146  
"Micro Shop" Office Requisites Ltd  
Cnr Waring Taylor & Featherson Sts. Ph 721-902  
Systems Technology & Associates  
49 Fitzherbert St. Petone. Ph 683-815

Campbell Systems Ltd  
11-13 Ghuznee St. Ph 727-773

Hands-on (Information) Ltd  
35-37 Victoria St. Ph 725-224

Power Corp Centres Ltd  
6th Floor, Nat West House, 132 The Terrace.  
Ph 729-792

### CHRISTCHURCH

C.C.L. Business Systems  
4 Oxford Tce. Ph 799-588

Computer Sth (CHCH) Ltd  
78 Oxford Tce. Ph 60-504

### INVERCARGILL

Invercargill Computer Services Ltd  
Cnr Kelvin & Spey Sts. Ph 86-959

### DUNEDIN

Business World Computers Ltd  
44 Filleul St. Ph 773-132

BURNETT 4428



## MURRAY'S COMPUTER VIL-LAGE

29 High Street  
Lower Hutt.  
693-313

**HARDWARE:** Commodore Miga, C64, C128, C128D, Commodore P.C.'s.

**SOFTWARE:** A full range of software for the above machines.

**PERSONNEL:** Murray Trickett, Antony Trapp, David Capie.

## COMPUTER BROKING SERVICES LTD

53 Boulcott Street  
P.O. Box 934  
Wellington  
(04) 723-481

**HARDWARE:** IBM compatible PC/XT/AT, with local area networking, printed circuit boards, Epson writers.

**PERSONNEL:** John Story.

## COMPUTER SCIENCES OF NZ LTD

64 Dixon St  
P.O. Box 929  
Wellington  
864-194

**SERVICES:** Training, Consultancy, Software support, Technical support.

**HARDWARE:** IBM Personal computers and PC36, IBM Baby 36PC, IBM Printers, NEC Printers, GTCO Plotters.

**SOFTWARE:** BRS/Search, ICIS - Insurance Consultants info. System Microsoft word, Microsoft Multiplan. IBM PC

Storyboard, IBM Displaywrite 3, Elke Plant Maintenance, Service management system, Inmagic text retrieval.

**PERSONNEL:** Colin Cook, Geoff Warren, Terry Lee, Farah Dwyer, Bill Doak.

## COMPUTER WORKS

Queens Arcade, Queens Drive.  
P.O. Box 30669  
Lower Hutt

693-998, 661-877, 664-944

**HARDWARE:** Sanyo and Commodore - IBM PC, Compatible Business Computers, Star Printers.

**SOFTWARE:** 'Controller' Job costing and accounting package. 'Breeze' Retail point-of-sale. 'GST Solution'. 'Power' accounting software.

**PERSONNEL:** Ralph Wilkinson, Dennis Turner, Warwick Brown, Angela Abbrhart, Diana Lusty.

## COMPUTERS FOR PEOPLE

35 Taranaki St  
Wellington  
859-675

**HARDWARE:** Sanyo, Wang, NEC, ICL.

**SOFTWARE:** Legal Systems, Dental Systems, Timber Systems, Plumbers Systems, CAD Systems, General Accounting and Productivity Packages.

**PERSONNEL:** John Foote, John Duncan.

## CONNECTOR SYSTEMS

23 Edinburgh St  
Newton.  
774-945

**HARDWARE:** On display will be products

for the reticulation of data as it relates to computer installations of all sizes. For RS 232, RS 422 connectors and cabling for terminal, patchfields and terminal blocks for larger installations.

**PERSONNEL:** Lewis Woodward, Maurice Trengrove, Alan Brown, Paul Devaney, Larry Olsen.

## DATA GENERAL

13th Floor, Grand Arcade Building, Willis St.  
P.O. Box 9735  
Wellington  
723-900

**HARDWARE:** D.G. Computers.

## GRANDSTAND COMPUTERS

P.O. Box 2353  
Auckland  
P.O. Box 37-206  
Lower Hutt  
637-539

**HARDWARE:** Amstrad Computers.

**SOFTWARE:** Full range of Recreation & Business Software.

**PERSONNEL:** Gary Thomas, Phil & Steve Kenyon.

## HEWLETT PACKARD

P.O. Box 9443  
Wellington  
(04) 877-199

**HARDWARE:** HP Vetra PC, Plotters, HP Touch Screen 2, HP3000 Mini Computer Series 37, HP Portable Computers, Laser Jets, Think Jets.

**SOFTWARE:** Advance Right, Executive Card Manager, HP Word, Gallery Collection, Execudesk, Executive Memomaker.

# We are a VAR dealer

## Our specialist systems include:

- Dentists, Medical
- Engineering
- Draughting
- Real Estate
- Legal
- Data FLEX
- Custom Systems
- Plumbing
- Timber Industry
- Furniture sellers

Our consultants aim to maximise the productivity our customers get from the complete systems we provide. We can evaluate any system on your behalf, integrate it into your environment and assist with any necessary software development or adaptation.



35 Taranaki St., Wellington. Phone 847-668, 847-628  
69a Rutherford St., Lower Hutt. Phone 664-069

IDEAS 910

**DEALERS:** Microshop, Systems Technology & Associates, Compusales Software & Hardware Ltd.

**PERSONNEL:** Glenys Tunnicliffe, Steve Brine, Andrew Jackson, D. Sykes.

### JENNESS HOME ENTERTAINMENT CENTRE LTD

173 High St  
Lower Hutt  
661-145

**HARDWARE:** Amstrad CPC 664, CPC 464, CPC 6128, MS 8256.

**PERSONNEL:** Ian Charles, Colin Charles, Kevin Billows.

### MAGIX COMPUTER SYSTEMS

65 Dudley St.  
Lower Hutt  
698-506

**HARDWARE:** Magix File Server AT, Magix Standard Profile AT, Magix XT, Magix PC, Magix Diskless.

**SOFTWARE:** Magix 4 GL Networking, Relational Data Base, Pathology, General Accounting, Motor Dealer, Software Packages.

### MICROBEE SYSTEMS NZ LTD

P.O. Box 26-045  
Newlands, Wellington 4.  
785-548

**HARDWARE:** Microbee 32K Standard & Premium Computers, Microbee 128K Standard & Premium Computers, Microbee Dot Matrix Printer.

**SOFTWARE:** Educational and Small Business.

**PERSONNEL:** Lyn Cruden, Trevor Smith.

### THE MICRO SOURCE LTD

46B Taharoto Road  
P.O. Box 33-797  
Takapuna  
491-760, 495-428

**HARDWARE:** Tallgrass - Disk Drives, Tape Drives, Network file server, Digital Communications, IRMA (3270 Coms Emulation), Smart Alec (IBM 536 Emulation), Keytronic - Keyboards ORCHID Technology, ORCHID P.C. net.

**SOFTWARE:** Open Access (V.2) New Release.

### MICROWARE (NZ)

P.O. Box 6309  
Wellington  
(04) 674-182

**HARDWARE:** Hardware and Software for the ZX spectrum, Q.L. and BBC Computers. Disc Drives and Interfaces for the spectrum and Q.L.. Modems, Printer Interfaces, and RAM Expansions. Q.L. Mouse and

"I.C.E." ROM Spectrum full size key boards from Saga.

**SOFTWARE:** Q.L. accounting package "Impact", which integrates Stock, Purchase, Sales and Nominal Ledgers.

### MICROPOST SOFTWARE & SUPPLIES LTD

Marac House, 105 The Terrace.  
Wellington  
736-265

**HARDWARE:** Plus Development Corp - HARDCARD Hercules Cards, Memory Upgrades, Hard disc Upgrades.

**SOFTWARE:** Extensive range of Business Software for the IBM PC, Apple or Macintosh computers at the lowest prices in New Zealand.

**PERSONNEL:** Fred Muys, Wendy Falconer.

### MITSUI COMPUTER SYSTEMS LTD

17-19 Wigan Street  
Wellington  
845-819

**HARDWARE:** Computers; CRDS, Sord, Toshiba. Printers; Diablo, Toshiba, Seikosha. Supplies.

**SOFTWARE:** CAD-CAM, WP-II, PIPS-III, DS. PIPS, RDS.

**PERSONNEL:** Valance Dimock, JTony Eastwood, John Hardwich, Greg Hall, Murray Bridge, Sandra Bogart-Grant, Sally Kavanagh.

### MITSUI COMPUTER SYSTEMS LTD, Sord Division

P.O. Box 9447  
Wellington  
845-819

**HARDWARE:** M343Sx2-20C Multiuser, M23EX/41 Standalone, M68 MX/20C and PL300.

**SOFTWARE:** "Plumbers Mate", General Accounting, Word-Processing and Data Base Management, Cad-Brain Mini and Graphics.

### MONTEK EQUIPMENT LTD

6 McElvie St.  
P.O. Box 78-118  
Auckland  
789-956

**HARDWARE:** Atari ST 520, Atari ST 1040.

For top performance  
your computer needs  
tender loving care...

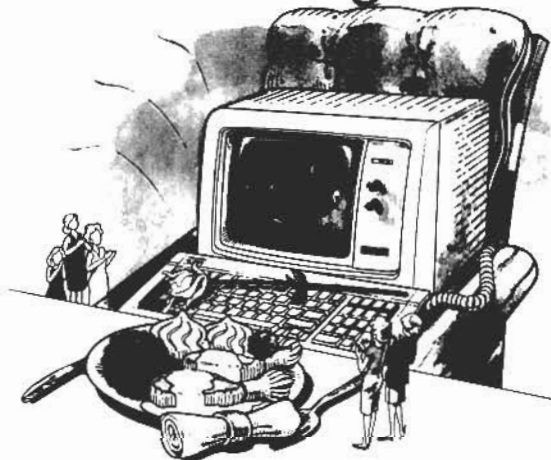

and a good  
'balanced diet'

WE SUPPLY THE TOP BRANDS...

- Maxell and BASF Floppy Disks
- BASF Computer Tapes
- PRECISION Printer Ribbons
- PRECISION Paper
- AFL Cleaning Products
- Disk Storage Units/Mailers
- Computer Furniture

**Compumedia Systems**

Auckland P.O. Box 3273 Tel (09) 444-6085 Telex 60835  
Wellington P.O. Box 11091 Tel (04) 851-548 Telex 31415

*We're No 1. in Computer Supplies!*

A MEMBER OF THE GASPARCORP GROUP OF COMPANIES



### AARDSOFTWARE

AARDSOFTWARE for your IBM-PC, C64 and Macintosh software requirements: competitive prices e.g. IBM Sideways \$85 Jet \$65 Flight Simulator II \$67 Norton Utilities \$98 C64 Print Shop \$58 Library Disc \$38 Prices Australian currency airmail extra \$3.50  
Enquiries:

**AARDSOFTWARE**  
P.O. Box 412  
Taylors Road  
NORFOLK ISLAND



# While the others make an exhibition of themselves, we'll offer REAL SAVINGS

In the final analysis, the only tangible difference between our competitors and an Exzel computer is the price.

Computer Imports have established the Exzel range as the most cost efficient IBM compatible computer on the market today. We've achieved this through our unique bulk buying facilities and minimal overheads — so that you, the customer, receive the price benefit.

With over 4,000 units installed, we have one of the largest user bases of business micro-computers in the country. Significant users include various Government Departments, and almost all the larger universities and technical institutes, as well as a wide spectrum of market leading companies and major corporations.

Apart from computers we have terminals, printers, add-ons, up-grades, networking, communications, C.A.D. and all at about half the price or less than IBM.

Every Exzel computer is covered by our comprehensive 12 months warranty and is subject to complete before and after sales service anywhere in New Zealand. Should you wish, an extended 5 year warranty is available when you purchase your Exzel.

The only thing that Computer Imports does by halves... is the price.

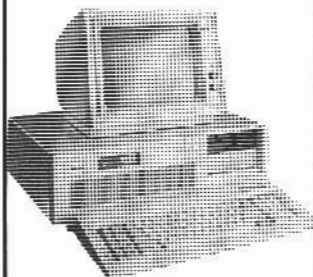

EXZEL AT  
\$8,150

**EXZEL** AT



EXZEL XT  
\$3,990

**EXZEL** XT

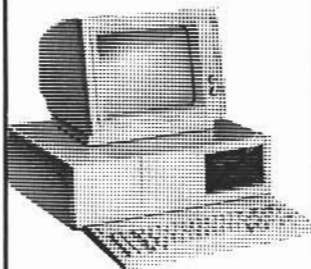

EXZEL PC  
\$2,750

**EXZEL** PC

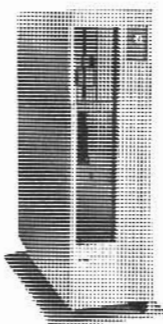

EXZEL MT  
FROM \$20,000

**EXZEL** MT

## from Computer Imports

We're the last people you should see  
at Stand 88-91, Overseas Terminal.



177 Willis Street, P.O. Box 2183, Wellington  
Telephone (04) 851-774

Contact us for local dealer information and client references.

CW1612

# BITS & BYTES LTD

## offers international news service plus software and computer services directories

In the four years since Bits and Bytes was launched, many changes have been recorded in the computer industry.

It has proved to be an industry being both volatile and tender as it determinedly moves through economic storms currently buffeting world trade.

But the computer industry is also separate. More than any other industry, it is the one often pointing to the way ahead for progressive businesses.

It has assumed a pioneering role – one which has taken its toll.

Bits and Bytes' prime objective is unchanged in charting those courses taken by computer companies, and presenting straight-forward, highly readable reports on both the machinery and the users.

It seeks to demystify the computer, and reveal opportunities for optimising useage of computers.

Today Bits and Bytes is New Zealand's most widely read computer magazine, because it is entertaining, and useful.

It therefore gives us pleasure to be able to extend this information service by offering three new services for computer users, distributors and dealers.

We look forward to your participation in these new ventures (described in this newsletter) – and we would welcome your comments and suggestions.

Regards



Gaie Ellis  
(Managing director, Bits and Bytes Ltd)



## NEWSBYTES

**NEWSBYTES** is an up-to-the-minute report on the computer industry, compiled from world-wide sources, which will be published fortnightly.

Included will be New Zealand industry reports, which will be subsequently fed into this global news service.

Newsbytes will enable New Zealand businesses to have almost immediate knowledge of important developments in the computer industry world-wide.

This information will be available exclusively to Newsbytes subscribers only.

A year's subscription to Newsbytes currently costs \$130 (for Bits and Bytes magazine subscribers) and \$150 per annum for those initiating subscriptions to both Newsbytes and Bits and Bytes. There will be 25 issues of Newsbytes within the year.

Enclosed is a subscription form.

Further contact for either subscription advice or to inform us of your company's news (or competitors' moves) can be through Bits and Bytes Ltd – contacts are Gaie Ellis and Steven Searle, at Auckland (09) 796-775.



## NEWSBYTES SUBSCRIPTION FORM

**NEWSBYTES**  
Bits & Bytes Ltd  
P O Box 9870  
Newmarket  
Auckland.

I wish to subscribe to Newsbytes. I am a current subscriber to Bits & Bytes. My subscription number is

.....  
Enclosed is my cheque for \$130.00.

I do not currently subscribe to Bits & Bytes. Enclosed is my cheque for \$150, being an annual subscription for Bits & Bytes and Newsbytes.

Name .....

Address .....

.....

.....

Machine type and/or particular interests

.....

.....

.....



# SOFTBYTES

MARCH

JUNE

SEPTEMBER

DECEMBER

SOFTBYTES is a directory of software available in New Zealand.

It is a quarterly up-date which will be published in March, June, September and December and distributed free to all Bits & Bytes subscribers. As well, it will be available generally on request, from Bits & Bytes.

Softbytes will be promoted in each issue of Bits & Bytes (70,000 plus readers).

The products will be listed alphabetically and in the following categories:-

1. Accounting
2. CAD-CAM
3. Communications
4. Databases
5. Entertainment/games
6. Education
7. Industrial
8. Spreadsheets

Each listing costs \$100 for the year; listings can be up-dated or changed before each publication release.

Listing MUST be accompanied by a signed order and conform to the format below:

**CATEGORY** (from above):

**Product Name:**

**Description** (up to 60 words):

**Distributor:**

**Address:**

**Phone No:**

## SOFTBYTES LISTING

SOFTBYTES  
P.O. Box 9870  
Newmarket  
Auckland

Please include the following listing/s in the next four issues of Softbytes. I understand that I will be given the opportunity to change or up-date the information up to one month prior to each issue.

Enclosed \$....., being \$100/listing (i.e.) \$25 for each listing per issue).

**Company:**

**Contact person:**

**Address:**

**Phone No:**

.....  
For and on behalf of the above-named company.

# COMPUTING SERVICE DIRECTORY

Do you provide services to the computer industry or computer consumers?

Then you should let them know about it.

In July we will introduce a new reference section in the magazine. Designed as a quick and ready reference for potential users, the directory will assume a regular place in Bits & Bytes.

Each directory listing space will be 6cm x 5.5cm in size

and is available at an INCLUSIVE price of \$85. You provide the copy and we will do the rest.

This directory is for the promotion of services. Product advertising is catered for elsewhere in our magazine.

Listings contracted for 11 consecutive issues will receive a 10% discount.

Bookings at Bits & Bytes: Auckland 796-775  
Wellington 753-207  
Christchurch 66-566



**BITS..&..  
..BYTES.**

NEW ZEALAND'S PERSONAL  
COMPUTER MAGAZINE

Third Floor, Denby House, 156 Parnell Rd  
P.O. Box 9870, Auckland  
Telephone: 796-775, 796-776

**SOFTWARE:** Range of business and recreational software, Cash link, Sound Synthesis.

**PERSONNEL:** Felix Meijer, Simon Page, Todd Somervell.

**NEW ZEALAND BIBLIOGRAPHIC NETWORK NATIONAL LIBRARY**

P.O. Box 696  
Wellington  
722-101

**HARDWARE:** Information Network consisting of texture database (mainly bibliographic) with links to INFOS - Statistics Dept. Expect to be showing CD - ROM showing British Books in print.

**SOFTWARE:** Western Library Network Bibliographic System plus BRS Search.

**NZPO - TELECOM**

P.O. Box 292  
Wellington  
737-625

**HARDWARE:** VTX-ONE Videotex Terminal, Computerphone.

**SOFTWARE:** Starnet - Electronic messaging service, Muraid - Public videotex service.

**PC POWER LTD**

Apex House, Queens Drive  
P.O. Box 44-161  
Lower Hutt  
(04) 693-050

**HARDWARE:** Joy Sticks, AST Boards, Maths Co-Processors, Mice, Digitizers, Plotters.

**SOFTWARE:** Largest range of Software in New Zealand. Send for free price list.

**PERSONNEL:** David Fleming, Adrian Marshall.

**PHILIPS NEW ZEALAND LTD**

68-86 Jervoice Quay  
Wellington  
(04) 735-735

**HARDWARE:** P2000 - YES, 3500 - 3800 multiuser, Printers, Videotex, modems.

**SOFTWARE:** CBA - POWER-SOFTWARE - STREDSHEETS - W/P.

**PROFESSIONAL COMPUTER SUPPLIES/Malam Equipment**

1st Floor, 3 Tennyson St.  
P.O. Box 6050  
Wellington  
859-073

**HARDWARE:** Malam Computer accessories. Input ez Ergonomic Computer, Furniture, Sunflex Voltfree Filters. Input ez Acoustic Printer Hoods

**PERSONNEL:** T. Steven, S. McLaren.

**RACAL-MILGO (NZ) LTD**

14-16 Manukau Rd, RTS Bldg, Epsom  
Auckland.

1st Floor, DB Hse, 10 Gilmer Tce  
Wellington  
AK: 504-309, WN: 730-313

**HARDWARE:** Intelligent soft strap network modems - Omnimode range of Data pump modems, short haul modems. CMS communications management system network contal, digital time division multiplexer.

Omnimix statistical multiplexers, data compressors, Dial up modems

**SOFTWARE:** ACMS system software - all software and resident firmware in equipment range.

**ROYCOM STSTEMS (NZ) LTD**

P.O. Box 3794  
Wellington  
856-674

**HARDWARE:** RCS Productivity, PC Equipment.

**SOFTWARE:** PC Software

**PERSONNEL:** G. Royal

**SCOLLAY COMPUTERS LIMITED**

Southpac House, 1 Victoria Street  
Wellington  
(04) 734-447

**HARDWARE:** Compaq Portable II, Compaq Portable 286, Compaq Deskpro 286, Compaq Deskpro, NEC APC III, NEC Pinwriters P6, P7, P5XL, NEC Spinwriters ELF, 8800.

**SOFTWARE:** Accounting Software, Word Processing, Spreadsheets, Financial Modelling, NEC - Nefax II

**PERSONNEL:** C. Barker, G. Hastie, C. Stuttle.

**SILCOM COMPUTER ACCESSORIES LTD**

4 Nelson Street  
P.O. Box 17-129  
Wellington  
(04) 851-331

**HARDWARE:** Acoustic Hoods for all

 **SANYO**  
BUSINESS COMPUTERS

 **commodore**  
PC BUSINESS COMPUTERS

**stair**  **printers**

# CONTROLLER

JOB COSTING and ACCOUNTING SYSTEM. For trades, manufacturing & all job orientated industries. Full system with costing, quotes, invoicing etc...

 **BREEZE**  
RETAIL POINT OF SALE SYSTEM

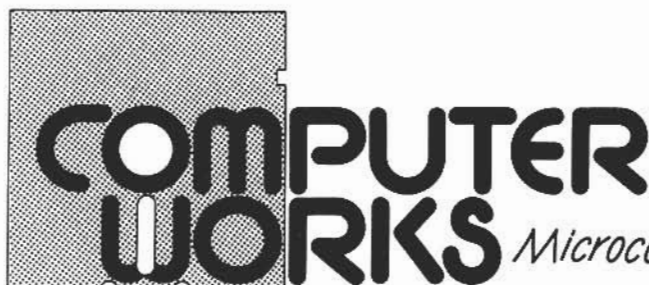
 **COMPUTER WORKS**  
*Microcomputers that mean business*

**THE GST\* SOLUTION**

Queens Arcade, Queens Drive · PO Box 30-669, Lower Hutt · Phone (04) 664-944 · 693-998 · 661-877



types of printers.

**PERSONNEL:** Graeme Gee

### SILKWOOD MANUFACTURING

8 Tironui Rd  
Papakura  
298-7089

**HARDWARE:** Full range of computer furniture for office or home, also ergonomic range of computer and typewriter work stations.

**PERSONNEL:** Kevin Shuker, Glen Hitch.

### SPERRY

13th Floor, Greenock House  
35 The Terrace  
P.O. Box 3960  
Wellington  
721-129

**HARDWARE:** Sperry Computers

**SOFTWARE:** Communications

### THE COMPUTER EXPERIENCE

C/- James Smith, Cuba Street  
Wellington  
730-348, 736-777

**HARDWARE:** Commodore 16, 64, 128, and Amiga, Atari 800XL, 130XE and ST 520 and 1040.

**SOFTWARE:** For C16/Plus, C64/128, Amiga, Vic 20, Atari 400/600/800/130, ST; Amstrad, Spectrum.

**PERSONNEL:** John Brocket, Rory Kilpatrick, Ian Ranford, Patricia O'Kane.

### VERBATIM NEW ZEALAND LIMITED

220 Willis St. Wellington.  
303 Broadway, Newmarket, Auckland.  
WN: (04) 858-615, AK: (09) 543-587

### STORAGE MEDIA & ACCESSORIES:

Datalife Floppy Discs and Diskettes, Datalife Microdisks, Datalife Head Cleaning kits, Full range of storage media and supplies.

### CALIBRE GROUP

3 Byron Avenue  
Takapuna  
Auckland  
491-764

**HARDWARE:** Novell local area networking, Tele CAT - 286

**SOFTWARE:** Essence business accounting suite

**PERSONNEL:** John Forser, Tony Dixon

### GENESIS SYSTEMS LTD

47 Station Road  
Otahuhu  
276-7349

**HARDWARE:** Full range Star printers.

**PERSONNEL:** S. Oswald, M. Weavers.

### COMPUTER IMPORTS

520 Queen St  
Private Bag  
Auckland  
395-344

### COMPEDIA SYSTEMS LTD

16 Woodson Place, Glenfield.  
Auckland  
171 Willis St, Wellington.  
P.O. Box 11-091  
WN: 847-623, AK: 444-6085

**HARDWARE:** Computer Supplies. Comprehensive range of computer supplies including: Maxell Flexible Disks, BASF Flexible Disks, BASF Computer Tape, Precision Computer Ribbons, Precision Computer Paper, Disk Minder Storage Units, AFL Cleaning Products, Acoustic Printer Hoods, Anti-glare Filter, Computer Furniture.

**PERSONNEL:** Peter

### DATATRONIC SYSTEMS LTD

16 Woodson Place  
Glenfield,  
P.O. Box 3273, Auckland  
(09) 444-6085

**HARDWARE:** Alloys Multi User PC Slave/16 allowing up to 31 Terminals to be supported from one server. Alloys Mass Storage Subsystems ranging from 20mb Hard Disk to 200mb Hard Disk with 60mb tape. Ampex range of ASCII & ANSI 3.64 Video Display Terminals. ABM range of Multifunction, Extended Memory, Input/Output, and Communications board.

**PERSONNEL:** Scott Green

### VIEWTEXT SERVICES LTD

P.O. Box 3956  
Wellington  
737-572

**PERSONNEL:** Russell Pickering

**Subscribe today and Save!!**  
*Up to 27 per cent on the cover price!!*  
**and have Bits & Bytes posted direct to you every month (except January)**

**YES! I wish to**  Subscribe  Renew my subscription **One year**

(Sub no. if known )  Adult \$18 + \$1.30 GST

School Student \$16  
+ \$1.60 GST

### Two years

Adult \$36 + \$3.60 GST  
 School Student \$32  
+ \$3.20 GST

NAME

ADDRESS

POSTAL ZONE

Invoice the above organisation

Do you own a microcomputer? Yes/No

If yes, which brand

I enclose cheque/money order No.

Please charge my credit card

Visa  Bank  Amex  Diners

No.

Signature

Expires / /

SUBSCRIPTION CARD

1. CANON DATA
2. PC POWER
3. ROYCOM SYSTEMS
4. COMPUMEDIA
5. COMPUTER CABLE SERVICES
6. COMPUTER SCIENCES N.Z.
7. NZ BIBLIOGRAPHIC NETWORK
8. COMPUTER SCIENCES N.Z. PHILLIPS
- 9.
- 10.
- 11.
12. MICROSOURCE
13. RACAL MILGO
14. IMAGINEERING
15. COMMODORE/COMPUTER VILLAGE
16. MICROWARE
17. GENESIS SYSTEMS
18. COMPUTER WORKS
- 19.
20. COMPUTER BROKING
21. CALIBRE GROUP
22. BARSONS
23. VERBATUM
24. MONTEK
25. CASE COMMUNICATIONS
26. NZPO TELECOMS
- 27.
- 28.
29. B.P.I.
- 30.
31. CONNECTOR SYSTEMS
- 32.
33. ASHTON TATE
34. PROFESSIONAL COMPUTER SUPPLIES
- 35.
36. GRAND STAND
37. MICROBEE
- 38.
39. SILKWOOD
40. MICROPOST
- 41.
42. SORD
43. MITSUI
44. ANDAS BUSINESS MACHINES
45. SPERRY
46. COMPUTERS FOR PEOPLE
- 47.
- 48.
- 49.
50. DATA GENERAL
88. - 91. COMPUTER IMPORTS
52. BUSINESS WORLD
53. HEWLETT PACKARD
54. NEC/SCOLLAYS
55. PHILLIPS
56. MITSUI/SEIKOSHA
57. MAGIX

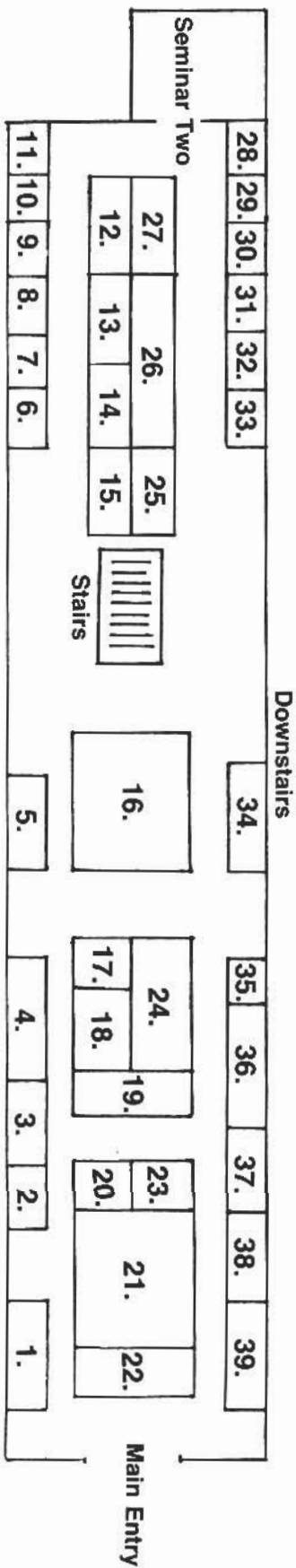
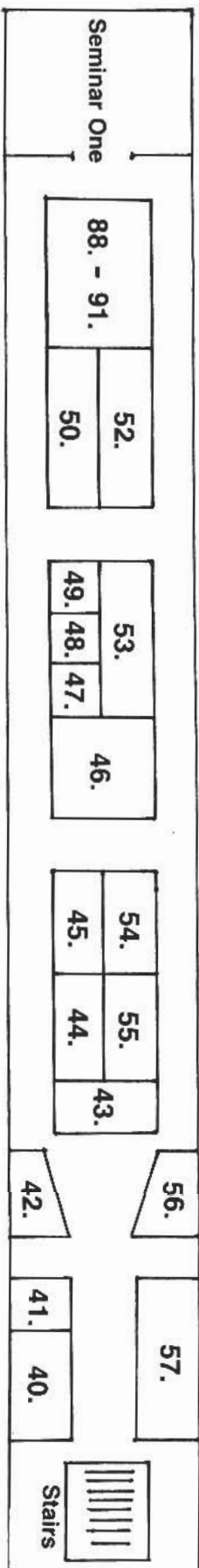



# In praise of networks

by Pip Forer

Local networks for microcomputers are potential nominations for the 'Slow-to-Grow' sleeping product award. In spite of anticipated growth in the business sector the preceived technical problems of integrating network developments into daily use seem to have raised significant reservations in buyers' minds.

In education however, networking was included as a desirable property for computer assessment in the Department of Education's first computer evaluation criteria. Networks, of various degrees of capability, are now firmly embedded in the education system.

We now have a situation where one significant group of schools runs stand-alone computers, another runs networked machines using a manufacturer's own network, and some schools operate third party networks on various machines.

## Hot debate

Debate is often heated on the value of networks, with strong loyalty often being determined largely on the experience and situation of the protagonists involved.

In the past, articles on networks have tended to be technical, with an underlying assumption that networking could only enhance a microcomputer configuration.

But the testing of network software, of running common software in a networking environment and administering a network have tempered this enthusiasm.

What are the real arguments for educational networking, and what issues does networking raise that are not raised by stand-alone machines?

## Three levels

Firstly we need to define "networking". Networked microcomputers are linked for the interchange of data and programs.

Networking does not preclude separate disk drives, and it does not mean computers must be together in one room.

It simply means any machine has direct avenues to others.

To do this, three levels of networks can be defined.

One is the **Uncouth File Server (UFS)**. The UFS allows a very simple form of resource sharing: several machines can address a single disk drive as if it were a normal, unshared drive.

In this way a single copy of a program can be accessed by several users. Problems emerge however in sharing data files.

The great benefit of the UFS is that one disk replaces many, so that both teacher or technician time and the number of disks required are minimised. Updates of a program, for instance, do not have to be copied for each machine.

Furthermore, progress records from all users can be kept on one disk, making class monitoring and administration a lot simpler since results from 10 or 20 disks do not need to be collated.

## Allocates space

The second level of network is the **Couth File Server (CFS)**. This embodies all the capabilities of the UFS and shares a disk, and maybe a printer, between users.

It also adds further capability by treating its network storage disk differently from a stand-alone one. In particular it allocates reserved space between users and usually has enhanced features to allow users to share files.

The benefit of CFS is that it too reduces disk need. It also (usually) offers security features and a control facility over space on the disk and access rights to different files.

The CFS is more useful for programs where interaction between users may be important.

Significantly, it can also support shared public files more efficiently. This is important when dealing with new information facilities like teletext systems in schools.

The final network option we can call the **Communications Network (CN)**.

This usually features a CFS as part of its capabilities but also allows direct communications between machines (for instance, message passing, or one machine solving part of another machine's problem).

Such capabilities allow more complex software to develop using distributed processing and resource management.

Users' current progress can be logged, programs can have users interacting in real time (as with a simulation featuring several players) and results in one machine can be made available to

several others very rapidly.

This permits the development of new forms of software in which the interaction between users becomes significant.

## Costs & benefits

All levels of networks offer the benefit of greater ease in managing larger numbers of users. This benefit is least significant with programs that are self-contained exercises where the user leaves the disk much as they find it (no student records are kept, no new data is input, no group project work involving inputs from several individuals is involved).

It becomes more crucial the more developed the application.

At the other extreme a whole body of applications cannot be run, or even conceived of, using stand-alone systems.

However some networks, like UFS, offer only restricted growth paths in offering more flexible computing.

On the other hand, networks require extra skill to utilise. This is often minimal for all users except for the individual who becomes the network manager.

Furthermore, not all software developed for stand-alone machines will work on all networks - so some skills in conversion, or a stand-alone option for users, is required.

In essence networks involve costs which are higher in the early stages of microcomputer use (when skill is scarce and software less sophisticated) and benefits which become more marked only as users become more mature.

The danger is that early users take the balance between costs and those limited benefits they perceive as inexperienced users and apply that measure to what they will want as time progresses. This judgement is almost certainly fallacious.

## Networks will grow

A supporter of educational networks could argue at least three significant trends are likely to swing the balance in educational microcomputing more and more towards network use.

One is the increasing use of the computer as a learning and information resource. The current trends are highlighting how useful data-bases are in a variety of learning contexts.

One can envisage various situations in which schools would like to have various data-bases on tap for various users: library resource files, local data files, joint project files, school news in an interactive videotext magazine.

All of these applications, which bring the computer in as a very relevant medium for education, function most efficiently and widely within a network.

If the computer is to become a power-

ful, widely used learning resource, then such a resource needs access to a powerful, local data source – as is availed by a network, rather than a constant shuffling of floppy disks.

Trends in mass storage technology enhance network options – the effective size of available disk storage on school networks is growing as schools move to 10 or 30 megabyte hard disks.

When mass storage devices offering gigabytes start to appear in the next year or two, such a trend will find plenty of momentum to sustain it. Schools will create significant local data bases for school community use.

Finally, more interactive software will emerge that utilises well-designed networks. At least three projects are underway here in New Zealand, aimed at providing network-oriented software featuring user interaction.

While the technical (and marketing) conditions necessary to allow such developments to happen are not existing for all machines, the trend for user-communities of network machines and software will continue.

In spite of these encouraging developments, several problems afflict network start-ups.

One is suitable software – a problem which varies in severity for different types of computers.

More significant are problems with training and support.

A network requires someone to be designated as the overlord. This role may not be too demanding of time but requires some time allocation in any organisation.

In general a network should reduce overall time required in presenting any given exercise, but the saving will often

be to individual teachers while the controller shoulders some overheads in reconciling the needs of different users.

The network can add capabilities and minimise overall administration time, but does require more formal institutional adjustment.

I would favour the argument that networks do complement the capabilities of computers in education.

Any application that seriously addresses Information Technology demands it: IT is about the pooling and use of information, not about students queueing around the only micro that happens to have data-base X on it at the time.

Most student uses benefit from being co-ordinated through a common system.

While the reader may differ I vote for the notion of networks, and Communications Networks at that.

The idea that in 1990 we will still only have isolated machines in any school is a depressing thought and will mean that we have missed many of the more exciting applications afforded in information technology.

Surely we will have a variety of communication links, of which an internal school network will be a significant component?

However, if networks are to be used, along with the sort of software applications that they allow, there are strong implications for education.

Support time needs to be made available for the overall manager. There are also considerable training implications.

Both college courses and in-service training need to prepare teachers for sophisticated network use and alert them to its potential, as well as cover the normal ground of stand-alone uses.

To date little training has been offered in this area at all. If one accepts the logic in support of networking then this situation should not persist.

This article has sought to argue that the choice to network is defensible on educational grounds, not from consideration of any least-cost bottom line.

As schools adopt the best ideas from wider society and move towards a transparent and widespread use of the micro, various forms of inter-machine communication will become commonplace in which networking will hold a significant position.

A more positive attitude is needed to the support and training requirements such a development will bring. ■

## Catalogue Advertisers

Canon Data  
Compumedia  
C.J. Battley  
Computer Broking  
Computer Imports  
Computers for People  
Computer Works  
Computer Sciences NZ  
Hewlett Packard  
Jenness  
Malcron  
Microbe  
Philips  
Scollays  
Southmark  
Verbatim

## EDITOR

Bits and Bytes, New Zealand's leading computer publication is seeking an enthusiastic editor to join our small and active team. We are looking for a person with a good grounding in the business market and the ability to become au fait with the computer industry. Our company is presently involved in expansion into electronic publishing and information dissemination and we would expect the appointee to become involved in the introduction of these new services. The rewards we offer are substantial and it is our practice to offer our staff shareholding and other benefits after an initial settling in period.

Phone: Gaie Ellis for a confidential interview on:

**796-775 or 534-9830**

Share clubs - companies - Individual investors

## SHARETRACKER

Check your bottom line with our **SHARETRACKER** spreadsheet template. Enter today's share prices and instantly recalculate your position, net of brokerage and stamp duty.

- Dollar and per cent gains and losses for individual shares and total portfolio.
- Capital gains (dollar and per cent) both for total portfolio and per shareholder (for share clubs).
- Share volumes, purchase dates and prices, cash assets, cash injections etc.
- Instructions and working sample included.

For IBM PC (Lotus 1-2-3), Apple II (AppleWorks), Macintosh (Multiplan, Excel), Commodore 64/128 (Multiplan), BBC (View). Price \$35-00 post free - Macintosh users add \$5-00. Send cheque or Visa/Bankcard number (include expiry date) with your order, to:

Infomedia Associates, Box 758 Wellington.



# PC POWER IBM SOFTWARE IMPORTERS

PC Power has the largest range of software and utilities for IBM PC's and Compatibles in the country. — If we haven't got it we'll get it

|                                  |         |                                |         |                                |         |
|----------------------------------|---------|--------------------------------|---------|--------------------------------|---------|
| BAKUP .....                      | 585.00  | The Hobbit .....               | 115.00  | Sideways Ver 3.0 .....         | 198.00  |
| Black Cauldron .....             | 125.00  | In *A* Vision .....            | 1495.00 | Sign-Master .....              | 695.00  |
| Chart-Master .....               | 945.00  | Javelin .....                  | 1495.00 | Speedreader II .....           | 225.00  |
| CopyII PC .....                  | 195.00  | Jet .....                      | 149.95  | Spreadsheet Auditor .....      | 395.65  |
| dBase III .....                  | 1295.00 | King's Quest II .....          | 149.95  | Symphony .....                 | Call    |
| Diagram-Master .....             | 1295.00 | Knowledgeman/2 .....           | 1588.75 | Timeline Ver 2.0 .....         | 1295.00 |
| Direct-Tree III .....            | 195.00  | Lotus 1-2-3 .....              | Call    | Turbo Lightning .....          | 225.00  |
| Dr Halo .....                    | 425.00  | Newsroom .....                 | 225.00  | Turbo Pascal Ver 3.0 .....     | 178.00  |
| Executive Presentation Kit ..... | 495.00  | Norton Utilities Ver 3.1 ..... | 245.00  | Typing Tutor III .....         | 159.95  |
| Flight Simulaotr Ver 2.12 .....  | 145.00  | Open Access .....              | 1185.00 | Volkswriter Deluxe Ver 3 ..... | 1125.00 |
| Framework II .....               | 1390.00 | PC Mouse .....                 | 550.00  | VP Planner .....               | 259.00  |
| Gem Collection .....             | 565.00  | PC Paint .....                 | 348.50  | Word .....                     | 895.00  |
| Gem Draw .....                   | 595.00  | Reflex .....                   | 275.00  | Wordstar 2000 .....            | 966.00  |
| Gem Graph .....                  | 725.00  | Sidekick .....                 | 165.00  | Word Perfect .....             | 995.00  |
| Hitchikers Guide to Galaxy ..... | 99.95   |                                |         | A.T.I. Training Packages ..... | Call    |

DEALER ENQUIRIES WELCOME

## LATEST RELEASES

|                |  |  |
|----------------|--|--|
| REFLEX         | * Superkey - \$195                     | Customise and automate your software, creates macros, data security. |
| TURBO LIGHT!   | * Lightning - \$245                    | Makes your PC Lightning Fast cuts disk access in half.               |
| DIREC-TREE III | * Norton Commander - \$195             | A quicker way to run your programs and take charge of your computer. |
| JET            | * Multimate Advantage - \$1195         | Popular Word Processor now includes Graphline and On-File.           |
|                | * Clide Art Personal Publisher - \$475 | Desktop Publishing for the IBM PC.                                   |

TO ORDER OR FOR  
FREE PRICE LIST ON  
OUR SEVERAL HUNDREDS  
PRODUCTS, CONTACT:—

## PC POWER LTD

1st Floor, Apex House, Cnr Queens Drive & Laings Rd.  
P.O. Box 44-161, Lower Hutt.  
Phone (04) 693-050.



**BOS** gives you true  
**MULTI-USER Accounting Software**  
...even on single-user PCs!

e.g., CANON, SANYO, WANG, IBM, etc.

**Previously on MINicomputers... now on MICROS!**

### BOS... PROVEN SYSTEM:

- BOS has 30% of all multi-user micro sites in the U.K.
- Reliability proven in more than 10,000 sites in 30 countries
- Transportable across more than 100 different computers
- High speed operation - from one to 25 VDU terminals
- FULLY SUPPORTED IN NEW ZEALAND

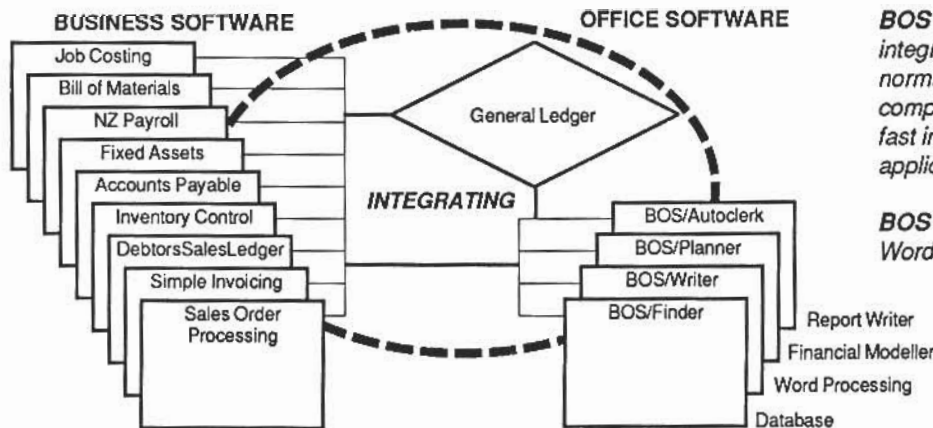

**BOS Business Software** is fully integrated and provides facilities not normally associated with micro-computers. These packages are very fast in operation and available for most applications.

**BOS Office Software** includes a Word Processor, Spreadsheet, Data Base package, and Report Writer which integrate with the business application software.

BOS Software (NZ) Limited • PO Box 221 • Auckland • Phone (09) 789 178 • Telex 60758

## Advice from the experts



Seminars – 1986 Wellington  
Computer Show

**SEMINARS HAVE LIMITED  
CAPACITY (100 people ONLY),  
ADMISSION IS TAKEN ON THE  
DAY AT THE SHOW ON A FIRST  
IN FIRST SERVED BASIS.**

### **COST:**

General Computing Series:  
\$5.00 each  
Communications Series:  
\$10.00 each  
OR \$35.00 for all 5.

**PRE BOOKING FOR COMMUNI-  
CATION SERIES ONLY (PHONE  
(04) 858-589)**

### **Corvus OmniNet LANs for**

- \*Apple Macintosh/Mac Plus
- \*IBM, Compatibles & Clones
- \*Apple IIe, DEC Rainbow
- \*Gateways to IBM & DEC
- \*Spooling/Disks/Back-up

### **IBM Compatible Clones**

- \*PCs from under \$2,000
- \*XTs from under \$4,000
- \*ATs from \$6-8,000

### **Bursters & Decollators**

- \*Extensive range from  
established manufacturers

**CBS: Est.1970, import directly  
from USA, UK and Asia.  
We service all hardware.**

**Computer Broking  
Services Limited**  
PO Box 934, Wellington.

### **NOTES:**

*Seminar notes will be provided.*

Seminar booking forms are a part of the BUSINESS PASS which can be obtained from WELLINGTON (04) 958-589.

### **VENUES:**

Main Seminar Room: Upstairs North  
End. (MSR)  
Seminar Room Two: North end  
exhibition hall. (SM.2)

### **GENERAL COMPUTING SERIES:**

#### **\* BUYING A BUSINESS COMPUTER**

- How to define your data processing requirements
- How to evaluate and select appropriate software and hardware
- HOW to organise a smooth installation

**Co-presented by Lawrence, Anderson & Buddle and Argos Data Systems**

- 1pm Friday (MSR)

#### **\* GUIDE TO GST AND COMPUTING**

- Defining your data processing requirements for GST
- How common accounting packages comply (or do not comply) with GST
- Efficient operating procedures

**Co-presented by Lawrence, Anderson & Buddle and Argos Data Systems**

- 2pm Friday 11th (MSR)

#### **\* PRODUCTIVE USE OF SPREADSHEET SOFTWARE**

- Overview of the functions and capabilities of a spreadsheet
- Evaluating what tasks are best performed by a spreadsheet

- 11 am Thursday (SR.2),  
11 am Friday (MSR)

#### **\* PRODUCTIVE USE OF WORD- PROCESSING SOFTWARE**

- Overview of the functions and capabilities of wordprocessing software
- Efficient implementation of wordprocessing in the workplace

**Presented by Polytech School of Secretarial Studies**

- 12 pm Thursday (SR.2),  
12 pm Friday (MSR)

#### **\* PRODUCTIVE USE OF DATABASE PACKAGES**

- Overview of the functions and capabilities of a database package
- Evaluating what tasks are best performed by a database package
- Comparison between database packages and 'dedicated' software

**Presented by Mike Wall, Consultant**

- 10 am Thursday (SR.2),  
10 am Friday (MSR)

# M A L C R O N



## Computer

## VILLAGE

**FOR PROFESSIONAL SERVICE –  
COMMODORE: AMIGA, P.C.'s, HOME.  
Business and Home; Software and Supplies.  
42 MANNERS ST., WELLINGTON  
PHONES: 720-989, 724-950**



New Zealand's  
leading  
highlighter



the marker  
that makes  
people read—  
and  
remember!

8 FLUORESCENT COLOURS—IDEAL  
FOR DEPARTMENTAL CODING

also available—

**STABILO  
BOSS 2**

The executive  
pocket model  
for those  
on the move



The only  
refillable  
highlighter

BOTH FROM  
YOUR STATIONER

Schwan · STABILO

**\* GUIDE TO COMPUTER  
AIDED DESIGN (CAD/CAE/CAM)**

- Overview of the functions and capabilities of the various CAD/CAE/CAM systems
- Efficient implementation of these in the workplace.

Presented by Tim McMahon, Cable Price.

– 3 pm Friday (MSR)

**\* COMPUTERS IN EDUCATION –  
ACHIEVING SUCCESS WITH  
SOFTWARE**

- How to recognise successful educational software
- Winning strategies in the educational use of software

- Common pitfalls
- Support from the Education Department

Presented by Ann Frampton, Curriculum Development, Department of Education

– 10.30 am Saturday (MSR)

**\* HACKERS GUIDE TO THE  
GALAXY**

Using your humble computer to communicate to the rest of the World from Home or the Office. This will cover the options and methods available and what can be accessed.

Presented by the Apple Users Group.  
– 1.00 pm Saturday (MSR)

CONFUSED?  
CALL  
**CHARLIES  
ANGELS**

The Caring  
Computer Company  
For friendly and  
personal service

TALK TO US about our  
full range of:-

- Ram Sets – Spreadsheets
- Memory & Multifunction boards – Databases
- Upgrade cards – Word processors – Accounting Pkgs
- Graphics cards & screens
- Utilities – Hard cards
- Networks – Programming tools – Tape backup units
- Cartridge refills – Printer ribbons – Diskettes – Printers
- Keyboards – EVEN FULL SYSTEMS!

**SPECIALS...**

**CASHBOOK** Just \$295

keeps a record of income & expenditure

**VERBATIM DISKS**

5.1/4" DS/DD \$55 for 10 OR  
\$150 for 30 plus storage box

**VP PLANNER** Only \$240

spreadsheet with everything  
1-2-3 has PLUS!

**WHO SAID BUSINESS  
HAD TO BE BORING?  
LET US BRIGHTEN  
UP YOUR FUTURE!**

**IF IT'S AVAILABLE, WE'LL GET IT!**

**C.J. Battley & Associates Ltd**

10 O'Connell St., Box 28-385, Remuera

(09)34546 / 34545

**PLUS  
FREE GIFT**  
worth \$30  
with every order  
over \$500

The company that takes the  
confusion out of computing



## COMMUNICATIONS SERIES:

These seminars are conducted by people who have a high level of practical expertise, both technically and from implementation.

### \* Integrating a Company's Communications into a Computer System.

Companies physically send documents, reports, data, both within their own operation and to clients and associated companies both locally and internationally. Is this necessary?

This seminar considers how and when computers can be used to meet these functions. It will cover dial-up or leased lines alternatives; interfacing to the telex, X.25, and electronic mail networks. How is it done, when is it useful, cost & efficiency justifications, software & hardware, domestic and international applications, the future, Common problems.

Presented by Ken Mortimer, Pacific-net Communications Ltd, & G. Freeth, Computing Technology Ltd, (Christchurch)

- 10 am Thursday (MSR)

### \* Local Area Networking

Covers the ability to connect any pc to any other pc or any other computer within the same building: Includes a look at the value of distributed processing, the types of networks offered, guide to network selection, evaluating software and hardware requirements.

Presented by Tony Dixon, Calibre Group

- 11.30 am Thursday (MSR)



**computer sciences  
of new zealand ltd**

Computer Sciences of New Zealand Ltd provides high quality professional products and services to many of New Zealand's largest and most successful organisations.

#### These include:

- **Consultancy**
- **Hardware**
- **Software**
- **Application development**
- **Training**
- **Total support**
- **Contract... programmers  
analysts  
operators**
- **Permanent placements**
- **Information engineering**

Consultants are available to discuss these services and demonstrate many state-of-the-art products on our stand.

**64 DIXON ST., WELLINGTON**

### \* WIDE AREA NETWORKING

The ability to connect any computer to any other computer anywhere in the world. This is a complex area with many technical and management issues.

#### Introduction

Where are such networks useful, what are the standards, what are the options, Telecom services and other network gateways, the use of dial-up, X.25 or leased lines, evaluation of needs, cost and benefit evaluation, common problems.

#### Software, Protocols & Gateways

Creating a network with different vendors hardware & software, interfacing problems and solutions, using different gateways and protocols, efficiently moving data around a network.

Presented by Bill Crighton, Comms Engineer, Case Communications.

#### Network Design & Management

How to design a network, design issues, implementation and control of the network and it's data...

Presented by Racal Milgo  
- 1.00 pm Thursday (MSR)

### \* Accessing Information Using Your Computer:

#### Using Videotex

- What videotex is and how it can be accessed
- Overview of major services available
- Advantages of videotex

Presented by Zealcorp, division of DFC.

#### Using Databases

Information databases presently accessible locally and internationally, and their usefulness.

Presented by Graeme Coe, NZ Bibliographic Network.

#### Using Electronic Mail Networks

Presentation of Starnet by George Bignall N.Z.P.O.  
- 3 pm Thursday (MSR)

### \* Case Studies in Implementing Computer Networks & Office Automation

Several companies who have implemented a O.A.S. and a network present their initial goals, the problems encountered, and the solutions, and how their system now operates. An ideal presentation for those wanting to relate networks to actual examples.

- 5 pm Thursday (MSR)



# The Colorful Solution to Data Organisation



## Colour is faster than words.

No confusion. Colour coded disks keep files organized and more efficient. Payroll on blue, accounts receivable red, accounts payable green, inventory yellow, customer files grey, backups orange. Less chance of backup/data disk confusion. 14 different colour options.

## Security

Store confidential data solely on a particular colour. Spot security violations immediately.

## Security identification

CenTech disks can be Foil Stamped on the diskette jacket for security identification in any of several different foil colours. Identify your disks at a glance.

## Warranty

Every CenTech Diskette is manufactured to the highest standards from the finest raw materials. They are as good as any and better than most. Each is warranted to be 100% error-free beyond 75% clipping level and manufacturing defect free or we will replace it at no charge.

**CENTECH**

## SOUTHMARK COMPUTERS LIMITED

2 Ngaire Ave. Auckland 3. P.O. Box 74-128, Auckland, N.Z. Telex NZ 60101 Telephone 504-609

DEALER ENQUIRIES WELCOME

TCC/SCL



“The COMPAQ Idea” in  
personal computers is now  
number one world-wide  
in Portables for business.\*



\*Source: Future Computing 1985

**COMPAQ<sup>®</sup>**  
**PORTABLE II<sup>™</sup>**

Let us show you why, at...

**SCOLLAY COMPUTERS LIMITED**  
SOUTHPAC HOUSE, 1 VICTORIA ST., WELLINGTON.  
P.O. BOX 4143. PH: (04) 734-447, TELEX: NZ3461, FAX: (04) 722-966

Your Authorized COMPAQ Dealer



# Why is Basic rubbished?

by Geoff McCaughan

## Subject: Disks

**[Q] What is the difference between 'Hard Sectored' and 'Soft Sectored' disks?**

**[A]** The uniform surface of a floppy disk must be divided into logical sections to enable the drive controller to quickly access a required piece of information.

The disk surface is divided into an arbitrary number of concentric 'tracks' each separated by a 'guard band' to prevent crosstalk between tracks.

Normally a disk will have either 40 or 80 tracks per side. Each track is further subdivided into an arbitrary number of 'sectors' each of which holds a fixed number of bytes — this number depends on the particular format, and might be anything between 128 and 1024.

A typical disk format might comprise 40 tracks of 16 sectors, each holding 256 bytes of data, for a capacity of 163,840 bytes per side.

On a hard sectored disk there are a number of timing holes which are used by the disk controller to determine the

location of each sector. These holes can be viewed through the small hole in the disk jacket beside the disk hub. The disk is said to be hard sectored because the number and location of the sectors is determined at the time of manufacture,

## Q & A: II

and cannot be changed by the end user.

A soft sectored disk on the other hand, has only one timing hole, the number and location of sectors being determined by the disk controller.

Typically the sectors are written on to the disk separated by sync bytes, only using the timing hole to determine the first sector on a track. A number of disk systems do not use the timing hole at all, but use a totally soft system.

As the soft sectored road is by far the most flexible (and we ARE talking about flexible disks!) it has gained considerable ascendancy over hard sectoring in recent years.

Soft sectored disks must be a boon indeed to the disk manufacturers, allowing them to come close to a 'one size fits all' disk in a sea of different formats.

## Subject: Modems

**[Q] I have a switch on my modem labelled 300 Bps Answer. I have never used it, what is it for? Will it answer the phone by itself?**

**[A]** Sorry, your modem will not answer the phone by itself. Auto answer modems are available, but it doesn't sound as if you have one, here's why:

A full duplex communication system requires at least two independent channels for data, one in each direction. Your modem does this by using one tone (or group of tones in the case of speeds over 600 Bps) for transmitting and one for receiving.

(Continued on page 54)

## Education

# Pluses and minuses "Book-keeping by Computer"

by Bill Heritage

The aim of this package is to learn book-keeping with the aid of a computer (using a computer for book-keeping tasks gets only an occasional mention).

The student is provided with a spiral bound paperback book and a floppy disk. The review disk was labelled "IBM format". Presumably other formats are available.

Having no access to an IBM PC I tried out the disk on a "compatible". The program did run, but I got a lot of strange characters on the screen or correct characters in the wrong places.

From the main menu the student selects one of five lessons.

Each lesson is split into a number of topics. Each topic is presented as one or more screens of text supplemented by key word lists and diagrams in the book.

Within a topic the student can move forwards or go back and re-read a screen.

At the end of the topic there is a multiple choice question,

## Sensible

I found this format very sensible. The text is clear and the questions demand pretty close attention to the topic.

Despite its title, this product will not teach you anything about the main feature of book-keeping, the double entry system.

Instead it describes the documents and records theoretically found in a simple business. Ledgers were not mentioned at all in the lessons I went through.

The methods described and terms used are as realistic as any textbook, though I've never met a "Register of Cheques Paid" in real life. The only error I found — and it occurs at least twice — is that chartered accountants are described as representatives of government!

When the lesson is completed the student is congratulated by the computer

and then told which questions were answered incorrectly.

What I wanted to do next was to go back to those specific topics and review them, but that was impossible. You have to plough through the entire lesson again to get to the topic you want to revise.

I found this a major drawback.

Another disadvantage is that there is no way (that I could find) of admitting to the machine that you are stumped and to ask what is the correct answer, please.

I suppose you could go through the entire lesson five times and select each answer in turn, but there should be an easier way.

The tutorial is clearly aimed at a level no higher than secondary school students. The lesson on The Bank Account is as basic as you can get.

Nor will this package, on its own, teach you much about book-keeping.

But it may get students started in a novel and interesting way.

A problem arises, when two computers wish to communicate, of deciding who will use a particular tone to transmit on.

Thus it was decided that the calling computer would use one set and the called computer would use the other, and the tones were labelled 'Originate' and 'Answer' accordingly. It is standard practice for a dial-up system (such as a bulletin board) to use Answer by default.

If you have only ever communicated with such a system, you will have only ever used Originate.

If you call a friend with a modem however, you will have to decide who is to use Answer and who is to use Originate. Note that it is purely a matter of choice, it doesn't matter if the calling party uses Answer, just as long as the other party uses Originate. It is however, good practice to follow the convention, as it helps to reduce confusion, which can be particularly important on long-distance calls.

## Subject: Communications

**[Q] I have tried calling a friend with my modem, but when I type something it appears on his screen and not mine. What's going on? My setup works fine when I call the BBS.**

**[A]** The setup for communicating between two terminals is a little different than when communicating with a host such as a BBS.

A computer acting as a host will normally echo every character it receives back to the terminal, so when you press a key, a byte is sent to the host, the host sends it back, and only then is it displayed on your screen. This is a useful method as it allows the terminal to verify the reception of every byte.

The important point to note, (a lot of people get confused on this one) is that the terminal does NOT echo characters back to the host. A little thought will show why this is so.

The terminal sends a byte, the host echos it back. The terminal, receiving a byte, echos it to the host, the host echos it back... and so on. It cannot work.

You can see from this that the host and the terminal operate in a fundamentally different manner, so when it comes to two terminals communicating we have to make some adjustments.

The standard procedure is simply to print characters to the screen of the terminal as they are typed. Most terminal programs can be configured to do this when set to Half Duplex (even though the communication is still, in fact, full duplex when talking with another terminal.) If you terminal has no Half Duplex option it is only useable in a terminal/host situation.

## Subject: Computer Video

**[Q] I have been thinking about buying a computer which I thought was good value, but a friend said not to as it was 'NTSC Video'. He said I should get one with PAL. What are NTSC and PAL and what is the problem?**

**[A]** NTSC stands for 'National Television Standards Committee' and is the acronym used to describe the colour television encoding system used in North America. NTSC is also referred to as 'Never Twice the Same Colour' because of the notorious lack of colour purity inherent in this system (contrary to popular belief, the U.S. of A does not always have the best of things).

PAL stands for 'Phase Alternation Line' (how's that for opacity?) and is used to describe the television system used in most of the rest of the world. An exception is France which vigorously promotes the home-grown SECAM system (trust them).

The crux of the matter is that the PAL and NTSC signals are incompatible, although one can usually obtain an acceptable monochrome signal. If the computer in question has its own monitor, and you are only planning to use it as a stand-alone system, the problem is not too great. If you ever needed to replace the monitor you may have some difficulty, as NTSC monitors are much harder to get (though not unobtainable).

A far greater problem arises if you have plans for sending the video signal to any existing device such as a TV, monitor, VCR etc, as this will just not work.

You will have similar problems if you wish to work with an incoming video signal; in either case my advice is, get a PAL unit.

It should be noted that the PAL/NTSC incompatibility is only a problem when using a composite video signal. An RGB monitor will normally give acceptable results when used with an RGB signal irrespective of the source.

## Subject: BASIC

**[Q] A lot of people rubbish BASIC. If it is so bad why is it so popular? Or, as it is so popular, how can it be bad?**

**[A]** You chose the right person to ask, as I am something of a 'BASIC basher' myself.

One of the reasons I make so much noise about other languages is that so many people I meet are unaware of the possibilities which different languages

can open up. BASIC is so common that many beginners forget that there is anything else.

Make no mistake, BASIC isn't all bad. It is fairly undemanding to learn, and its interactive nature can be a boon.

It is fairly flexible (surprisingly so in some cases) and is something of a common denominator between many different computers, although there are too many dialects for any hope of compatibility.

For a huge number of minor applications the convenience of BASIC wins out over any advantage another language might have. Plus, most computers either have BASIC supplied, or freely available.

But go to your friendly local computer store, and buy a program, any program. Ten to one it isn't written in BASIC. Why? I'll list three of the major reasons.

**Speed.** Even when compiled, BASIC is a bit of a slug. Obtaining acceptable results from a language which is not really designed to be compiled is only possible at the expense of very long compile times.

**Structure.** The thing that really weighs against BASIC in the minds of many programmers is the problem known as the 'Dreaded Spaghetti Syndrome'. It is possible, and sometimes necessary in the interests of efficiency, to write BASIC code which is convoluted, obtuse, and downright messy.

While such programming methods may produce the desired results, it can be a nightmare for anyone (even the original programmer) trying to modify the code at a later date.

In the hands of an inexperienced programmer these problems are magnified, and can become a serious liability, as BASIC will happily let you jump out of a loop or a subroutine, for a while.

**Efficiency.** In terms of programming effort, speed and memory requirements, BASIC can be quite inefficient. While it is true to say that almost any task may be undertaken by a BASIC program, it is also true that there is probably another language that can do the job better.

As for popularity, BASIC is more probably common than popular - after all, in the fourteenth century everyone had lice, but they still weren't very popular. It is axiomatic that a knowledge of BASIC does not a programmer make; I know many people who use BASIC, but only a handful of programmers.

And the 'real' languages? My preference is for Promal, C, Modula 2, Comal, and Prolog, and if you really want to get the job done, assembler is difficult to beat.

So if you have written a 9600 Bps terminal multitasking to a polyphonic synthesiser and a solid-modelling CAD package on a priority interrupt system, all in BASIC, don't write and tell me about it, just think what you could do with a real language. ■





# is here

# and



# is



## HARDWARE AND SOFTWARE IN STOCK NOW!

### SOFTWARE SELECTION:

#### Business Applications...

|                                       |          |
|---------------------------------------|----------|
| AMIGA TEXTCRAFT                       |          |
| Powerful wordprocessor                | \$149.95 |
| VIP PROFESSIONAL                      |          |
| Spreadsheet/Database 256 x 8192 cells | \$595.00 |
| LATTICE UNICALC                       |          |
| Fully featured spreadsheet            | \$249.50 |
| MAXIDESK                              |          |
| Sidekick type deskset                 | \$249.50 |
| MAXICOM                               |          |
| Communications package                | \$249.50 |

#### Graphics Applications

|                               |          |
|-------------------------------|----------|
| GRAPHICRAFT                   |          |
| Powerful entry level graphics | \$149.50 |
| DE LUXE PAINT                 |          |
| Advanced painting program     | \$375.50 |
| AEGIS ANIMATOR                |          |
| Metamorphic animation package | \$425.50 |

#### Lattice Programming Aids

|                                    |          |
|------------------------------------|----------|
| TEXT UTILITIES                     |          |
| Language independent utilities     | \$249.50 |
| SCREEN EDITOR                      |          |
| Enhanced programmer's editor       | \$239.50 |
| dbc III LIBRARY                    |          |
| Create dBaseIII compat. files in C | \$495.50 |
| MacLIBRARY                         |          |
| C routines Mac style!              | \$299.50 |
| MAKE UTILITY                       |          |
| Intelligent multiple file utility  | \$249.50 |

#### Entertainment

|                  |          |
|------------------|----------|
| MINDSHADOW       | \$ 86.95 |
| HITCHIKERS GUIDE | \$118.95 |
| MUSIC STUDIO     | \$ 97.95 |

\*List complete at copy deadline. Check for additions  
Overviews are available for all software packages on request.

## WE ARE THE LARGEST COMMODORE DEALERSHIP IN NEW ZEALAND!

**FIRST** for Specialised knowledge  
**FIRST** for Service, **FIRST** for **AMIGA**

### HARDWARE

Amiga 1000 System complete, comprising Computer with 512K RAM, 3.5" disk drive (880K) colour monitor mouse, keyboard, and software - Kickstart, Workbench. Microsoft Basic and Amiga Tutor, Kaleidoscope. \$3995.  
2nd 3.5" disk drive \$795.00 extra.

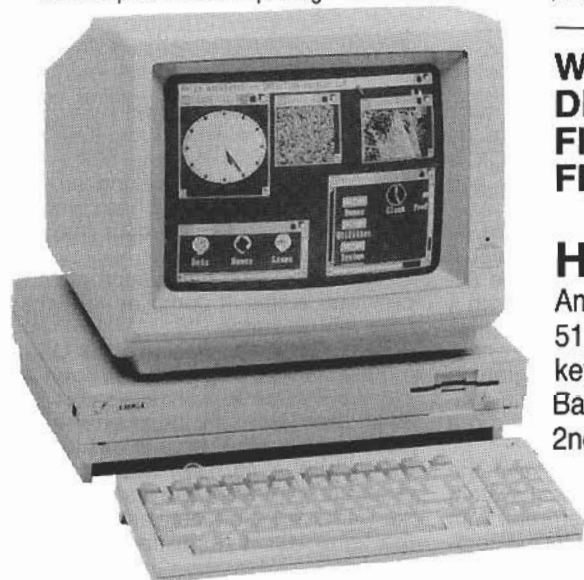

93 ASHBY AVENUE  
ST. HELIERS, AUCKLAND 5.

**To ASHBY COMPUTER CENTRE**  
93 ASHBY AVENUE, ST. HELIERS, AUCKLAND 5.  
TELEPHONE 588-301.

YES! I want to be among the first with an Amiga! Please record my order now to ensure delivery from the limited first shipment due end June.

|                                      |                         |
|--------------------------------------|-------------------------|
| Full system order at \$3995.00 ..... | Enclosed is 10% deposit |
| Extra 3.5" drive at \$ 795.00 .....  |                         |
| Software as per attached list .....  | \$.....                 |
| Information only than you .....      |                         |

# Two Pascal compilers for C64

by Andrew Bevin

Until recently serious Pascal programming had been out of the reach of the Commodore 64 owner.

Now, though, as the Commodore 64 reaches a ripe old age, full implementations of Pascal are appearing.

Most notably in New Zealand is Oxford Pascal for the C-64 and BBC micros. In the USA a small company has also released two Pascal compilers for the C-64, Kyan's standard and advanced Pascal.

Both Kyan and Oxford Pascal are full implementations of pascal, as set out by Niklaus Wirth. Virtually all pascal programs will run on both Kyan and Oxford with little or no modification. In fact, as both Kyan and Oxford Pascal store their text files in the same disk format I can compile programs written on the Kyan text editor with both the Kyan compiler and the Oxford compiler.

But despite these similarities there are big differences between the compilers.

## Oxford

Oxford Pascal is packaged in a book sized plastic cover, not unlike a video cassette box. Inside is one disk and a small users manual. The manual is about a 100 pages and is divided into two sections. The first section is a tutorial on pascal and Oxford's implementation of it. The second section is the reference manual.

The pascal system, on the disk, is copy protected, which is unfortunate as this makes it necessary to swap disks to save, load or compile programs, unless you have two disk drives.

Pascal compilers on larger computers generally are composed of two or more programs:

a text editor - to write the program  
and a compiler - to create the machine language program from the text file.

Oxford Pascal combines both into one program which gives a system that, when loaded, does not need use the disk drive again, except for file loading. This is an advantage on the C-64 due to its abysmal data transfer rate to and from the disk drive.

## Text editor

Once Oxford Pascal is loaded the screen comes up in what appears to be BASIC. But do not be fooled, BASIC no longer exists. The computer is now in the Pascal text editor.

To enter a pascal program it is typed in just as a BASIC program is typed in, with line numbers! The line numbers are ignored by the pascal compiler, they are used purely to allow Oxford Pascal to dispense with a full screen editor.

Pascal, quite simply, looks awful with line numbers but luckily this does not have to be endured. When a pascal text file is saved, it is saved (without line numbers) in a format that is exactly the same as used by the majority of C-64 word processors, including Easy Script.

So rather than use Oxford's line editor for large programs you can compose your programming master pieces on your word processor.

In Oxford Pascal's text editor you can compile programs and even run programs without losing the pascal system. This is as close as you can get to a BASIC-like interpreter with pascal.

As the user gets more advanced he may wish to write bigger programs than the available memory under the pascal system. This can be achieved by typing DISK.

This will blow away the compiler and leaves you with just the text editor, making available a lot of memory for program text.

## P-code

In DISK mode Oxford Pascal is more like the traditional pascal system. In order to compile a text program it is necessary to save the edited file and then load in the compiler.

Oxford Pascal does not compile its programs directly to machine code. It compiles to pseudo-machine code (P-code). In effect Oxford Pascal is both a compiler and an interpreter. It compiles pascal to P-code and the pascal system interprets the P-code as the program is running. This means that the pascal system always has to be present to run a program.

You can make programs have the ability to run without the pascal system by including the P-code interpreter with the P-code file. This is done by the command LOCATE. It has the disadvantage of adding, approximately, 12K to the program file, making even small programs rather heavy weight.

The use of P-code also affects Oxford Pascal's speed, as even partially interpreted systems run a lot slower than full compilers. The sieve of Eratosthenes bechtest bears this out (see table). Oxford Pascal is three times faster than BASIC, yet it is six times slower than Kyan Pascal.

## Graphics slow

Oxford Pascal has a number of extensions to the language to enable easy access to more machine specific tasks like graphics and sound.

I was disappointed with the graphics commands, they were very slow (compared to the graphic commands on Commodore's Super Expander) and, incredibly, it is only possible to use a portion of the graphic screen. The x-coordination in all of the graphic commands only allows values between 1 and 255, leaving positions 256-320 unable to be used.

It is possible in Oxford Pascal to link compiled programs together. This allows procedures that will be used by many programs to be compiled separately. This is a powerful feature, one that is absent on some professional systems that run on big micros.

Overall Oxford Pascal offers a full pascal system which is geared well for both the beginner and the professional programmer. It's drawbacks are the lack of a full screen editor, the copy protected disk, and poor graphic's extensions.

## Kyan advanced

Kyan Software released Kyan Standard Pascal in late 1984 and then Kyan Advanced Pascal in early 1985. Kyan Standard Pascal follows along the same lines as Oxford Pascal. It has combined the compiler and text editor into one, and compiles to P-code.

Kyan Advanced has a separate compiler and editor. It compiles straight to machine language.

Kyan Advanced Pascal costs US\$20 more than Kyan standard. If Kyan Advanced Pascal is purchased a copy of Kyan standard is included on the disk. Kyan Advanced Pascal is easily worth the extra cost so I will concentrate this review on it rather than the standard version. I have included Kyan standard in the benchtest, though, for comparison purposes.

Kyan Advanced Pascal comes in a large brown envelope from San Francisco. In it is an A4 sized manual of around 100 pages bound together with a plastic ringbinder, inside of which is a disk.

Along with the manual is six pages which comprise a newsletter on updates for the pascal system. The newsletter can be subscribed for US\$15 per year.

The manual is a tutorial on Kyan Pas-



cal with the reference material mixed in. Fortunately there is an index. The manual shows signs of being rather hastily put together, but despite its minor omissions it is suitable for both the beginner and the experienced programmer.

The disk contains Standard Pascal, Advanced Pascal's text editor, compiler and library files. Along with the Pascal language there is a whole pile of sample programs and 'include' files (more about these later). Best of all the disk is completely unprotected therefore as many copies as required can be made. This enables a copy of the pascal system to be on every work disk, avoiding any disk swapping.

Kyan Advanced Pascal's text editor is a full screen editor that is as good as a word processor. It only operates on 40 columns and it doesn't have a dedicated word processor's fancy features, but then it only uses up 3.5K of memory.

The compiler takes up about 35K of memory, but because of the way it accesses the program file it can compile a program that will use up to 40k of memory.

After the compiler is loaded it prompts the user with three questions:

```
FILE:
LISTING(Y/N):
HARDCOPY(Y/N):
```

The file is the program to be compiled. Typing Y to listing, incredibly, gives an assembler listing of the compiled code complete with comments! Hardcopy allows for the output of errors to the printer or if a listing is wanted, the output of the assembler listing to the printer.

The finished compiled program will run without the compiler and, generally, is only slightly larger than its text file. The library file has to always be on the same disk as any pascal programs, as every pascal program loads the library when it is first run. The library is approximately 10K in length.

## High speed

The speed of Kyan Advanced Pascal in the sieve of Eratosthenes benchtest is rather amazing. It is 6 times faster than Oxford Pascal and 19 times faster than BASIC. I have also included the time Kyan takes to load in the library on the first run. Even with this taken into account it is still three times faster than Oxford Pascal.

Kyan Advanced Pascal does not have the graphics and sound extensions of Oxford Pascal built in, but it does have "include files" that contain graphic procedures and other extensions.

An "include file" is a text file which will be merged with a program at compilation time by the compiler if the program specifies it. Kyan Advanced Pascal does not have the ability to link compiled programs together, but this is partially compensated for by includes.

### Table of sieve of Eratosthenes results

| Language                               | Time to find all Primes between 1 and 7000 |
|--|--|
| Kyan Advanced Pascal                   | 14 seconds                                 |
| Kyan Advanced Pascal with initial load | 38 seconds                                 |
| Kyan Standard Pascal                   | 85 seconds                                 |
| Oxford Pascal                          | 88 seconds                                 |
| C-64 BASIC                             | 268 seconds                                |

One extension to Kyan Advanced Pascal that is worth noting is its ability to write inline assembly language as the main body of a procedure. This enables users to write hardware related procedures and use them in their pascal programs.

## Remarkable

Both Kyan and Oxford Pascal are remarkable products. Implementations of pascal like these are just not heard of in the game orientated market of home computer software.

These products cannot be classed as mere toys, and in many areas are directly comparable to their bigger, more expensive, brothers.

As Kyan Advanced Pascal and Oxford Pascal are both in the same price range they are both competing for the same market.

Oxford has the immediate advantage of being marketed in New Zealand. Whereas Kyan is only available by mail order from the USA. But for ease of use and pure power I would rate Kyan the better system.

Oxford Pascal retails for \$179. Kyan retails for US\$69 plus US\$12 air freight. With the Kiwi dollar at .52 US dollars that means a New Zealand price of \$157.60.

### Listings of the BASIC and pascal versions of the sieve of Eratosthenes benchtest.

```
10 size=7000
15 dim f(size)
20 print "1 iteration"
30 count=0
40 for i = 0 to size
50 f(i)=0
55 next i
60 for i = 0 to size
70 if f(i)=1 then goto 210
80 prime=i+i+3
90 k=i+prime
100 if k>size then goto 200
110 f(k)=1
120 k=k+prime
130 goto 100
200 count = count+1
210 next i
220 print count,"primes"
230 end
```

```
program prime;
const size=7000;
var
  f:array [0..size] of boolean;
  i,k,prime,count:integer;
begin
  writeln('1 iteration');
  count:=0;
  for i:=0 to size do f[i]:=true;
  for i:=0 to size do
    if f[i] then begin
      prime:=i+i+3;
      k:=i+prime;
      while k<=size do begin
        f[k]:=false;
        k:=k+prime
      end;
      count:=count+1
    end;
  writeln(count,' primes')
end. ■
```

## Remarkable library

Remarkable Enterprises, a clone distributor in Dunedin, has taken on the massive software library service of US-based PC Special Interest group (PC-SIG).

It features low-cost discs of utilities and various programmes, mainly public domain, and title directories for IBM, Apple, Commodore and other computer brands.

## Datacom busy

Datacom Group has successfully installed three major projects recently.

For the Ministry of Ag and Fish it has installed for in-house use (initially) a videotex network with daily updates of commodity prices, research and news reports.

For Renouf and Partners, a Wellington stock-brokerage, it has an accounting system soon to be linked with the stock exchange's new computer system.

And for the NZ Stock Exchange, Datacom has installed a system linking the country's four trading floors, computing share quotations and trade information.

The next phase will be on-line broker-to-broker accounting.

The brokerage system is being run on three Tandem computers.

# Driving spreadsheets & racers

by Craig Beaumont

Spreadsheets are one of the most versatile types of application programs.

A spreadsheet is basically a grid of pigeon holes or cells into which you can place either a piece of data or a formula that operates on the data in other cells.

From such a framework comes the ability to perform tasks like financial planning, accounting, data analysis and other types of number crunching.

If you have a 464 without diskdrive then you have a choice between Mastercalc by Campbell Software and Easi-Amscalc by Saxon Computing.

They have similar abilities in terms of sheet size, number of functions and ability to produce bar graphs.

They have only basic windowing facilities but will work in mode 1, unlike the disk based CP/M spreadsheets described later.

Both perform calculations and other operations quickly – often faster than the CP/M spreadsheets which pull their instructions off disk.

## Standard operation

Of the two I would recommend Easi-Amscalc because it is more standard to operate than Mastercalc. This is important if you upgrade to other spreadsheets.

Mastercalc indexes both rows and columns numerically so the first cell is called c1r1 in formulas when most other spreadsheets would call this cell A1.

Also Mastercalc stores its 99 formulae allowed outside the sheet itself.

This has its advantages – when you edit say Formula 1 then all the cells that use Formula 1 are adjusted.

After using other spreadsheets I found it took a while to get used to this system.

With a diskdrive and CP/M 2.2 you have the option of using Microspread by Saxon Computing as well as the two above under Amsdos. I have not used it but I expect it is more advanced than the other two.

When it comes to making graphs you will require Micrograph, which will display data from Microspread in a variety of ways and allow you to dump the graphs to printer.

## SuperCalc 2

CP/M Plus gives you access to the likes of SuperCalc 2 by Sorcim of California and The Cracker by Software Technology of Birmingham.

Overseas reports indicate the British

product wins in terms of quality with its looping facility and built-in graphics. I'm looking forward to seeing it – until then let's see why SuperCalc2 is worth \$200.

Moving between Lotus 123 and SuperCalc 2 isn't uncomfortable as SuperCalc2 has a similar approach to accepting commands.

Help is available at each stage by typing ? If you really get stuck the voluminous manual is always handy.

With about 40 functions including log, trig, financial, IF, boolean, error checking and calendar you can perform some complex operations. The calendar functions give some interesting replies on December 25th and July 4th!

SuperCalc2 lacks the ability to graph the results of these operations except in the most rudimentary way using a format that displays numbers as a row of stars.

The picture attached shows an example of this. Here Microspread used with Micrograph has a distinct advantage.

|   | A | B     | C     |
|---|---|-------|-------|
| 1: BREAKDOWN OF CASHFLOWS FOR JUNE 1985 |   |       |       |
| 2:                                      |   | TOTAL |       |
| 3: NET SALES                            |   | 21834 | ***** |
| 4: COST OF GOODS SOLD                   |   | 6415  | ****  |
| 5: -----                                |   |       |       |
| 6: GROSS PROFIT                         |   | 14969 | ***** |
| 7: RESEARCH & DEVELOPMENT               |   | 3421  | **    |
| 8: MARKETING                            |   | 4827  | ***   |
| 9: ADMINISTRATIVE                       |   | 2657  | +     |
| 10: -----                               |   |       |       |
| 11: TOTAL OPERATING EXPENSES            |   | 10905 | ***** |
| 12: INCOME BEFORE TAXES                 |   | 4064  | **    |
| 13: INCOME TAXES                        |   | 1626  | +     |
| 14: -----                               |   |       |       |
| 15: NET INCOME                          |   | 2438  | +     |

The ability to Copy, Replicate and Move pieces of the sheet around is standard but there is no checking of whether the operation will overwrite data you may in fact want. That is, unless you have used the Protect function on that area of the sheet.

Both horizontal and vertical windows are supported with a synchronisation option, which is useful when your sheet gets large.

Maximum sheet size is 63 columns by 254 rows, that's about 16000 cells compared to 3000 on Mastercalc and 7000 on the 6128 version called Mastercalc 128.

## 'Macro' files

Other features of SuperCalc2 include extending the real range from -9.9E-62 to 9.9E62. It can load segments of other sheets from disc. It has Execute files similar to macros found on other spreadsheets.

The sorting of columns or rows in either descending/ascending order is easy using the Arrange option. Also users can define their own formats – perhaps a percentage format with 3 decimal places.

In all SuperCalc2 is more able, professional and easy to use than its Amsdos counterparts.

## 3D Grand Prix

Wow!! is all I could think when playing 3D Grand Prix for the first time. To progress through the eight track international series you must come 1st, 2nd or 3rd in each three lap race.

Your competition can be very unsporting. They are slow through the corners, drive in the middle of the road, and if they bump you from behind you are the one that gets damaged. When the car is damaged either through crashing or skidding off the course there is a small delay before you start again. The car does not suffer except when you overheat the engine, it starts making a spluttering noise and you lose acceleration.

The sound is the best I've heard on the Amstrad – the skidding noise is especially effective. The graphics are very much like Pole Position on the Atari, maybe not so smooth. The four gears can stand a lot more punishment than any real racing machine could handle – with no brakes the only way to stop in a hurry is to crash down through the gears!

When you eventually make it to the 8th track you are faced with a night race against cars that you see only as passing blurs.

I've not actually got through this stage, but on the way I learnt a few tricks like slipstreaming, not changing down through corners and if necessary using the curb to slow down.

While talking about speed two products designed for this are Turbo Pascal 3.0 by Borland International and a hard disk system selling for £999 (\$2600) in Britain.

After using Turbo for only a week I have already filled a disk just exploring its abilities.

If you are serious about using pascal and have CP/M Plus then this is the answer – it makes Hisoft Pascal look like a toy.

The hard disk is being advertised as part of a network system for using Amstrads in education. It would be one of the most interesting peripherals to hang on the back – a little more expensive than your average mouse or modem though.



# Gaining extra disk space

by Paul Left

Apple's DOS 3.3 does not use the magnetic surface of a disk as efficiently as more recent systems.

For example, normal DOS is only capable of initialising and accessing 35 tracks, each of 16 sectors.

As each sector holds 256 bytes, each track holds 4K bytes and the capacity of 1 disk is therefore 140K. Take away the 3 tracks used by DOS and we are left with even less available space on disk.

As many Apple users continue to use DOS 3.3 rather than ProDOS for storing their own files or programs on disk, it is worthwhile making modifications to increase the storage capacity of disks.

Even though the amount gained may not be huge, the process is simple and educational.

## Extra track

Some of the limitations on disk capacity are brought about by the hardware itself; the Apple Disk II, for example, is only designed to access 36 tracks. This is one more than DOS allows, however, and it is easy to alter DOS to use this extra track.

Other disk drives are capable of accessing even more tracks than the original Apple drives, and if you have a 'foreign' drive attached to your Apple II you should check the manual (if available) to see how many tracks it can access.

If you are not sure, you'll have to find out your drive's capabilities by trial and error if you want to use it to the maximum. Otherwise, you should assume that any drive is capable of accessing 36 tracks, just like the 'official' Disk II.

Before starting, convert the number of tracks you can access to a hexadecimal figure. For normal DOS, this is \$23, and for 1 extra track the figure is \$24.

A 'Super 5' drive can access 40 tracks, and this converts to \$28.

This is the figure you must write to disk to alter DOS in order to gain the extra 4K per track.

Note, however, that because track numbering starts from \$00, the highest numbered track will be 1 less; that is, if you are using \$24 tracks, the number of the last track is \$23.

There are three steps necessary to alter DOS to use these tracks:

(1) Alter the DOS on a disk so that it will initialise the increased number of tracks;

(2) Use this new DOS to initialise a

blank disk;

(3) Alter this new disk so that it informs DOS correctly of its increased capacity.

Make sure you use a copy of a disk with normal DOS for the first step.

This disk can be full of files if you wish, but note that it will not have any extra tracks itself, just the capacity to format extra tracks on new disks.

First, boot your trusty sector editor and read in track \$00, sector \$08 of the disk you are going to use in step 1.

The second-to-last byte of the sector should have the value \$23; that's how many tracks DOS will format during an INIT. Alter this byte to \$24 (or whatever other maximum number of tracks your drive allows) and write the sector back to disk.

Notice that in Figure 1 the byte has been altered to \$28, as that's how many tracks my Drive 1 can access.

Figure One:

```

BB- 55 78 54 40 A0 B9 5A 4A
9C- 4A 4A 4A A8 60 19 A0 02
98- B1 40 6A 66 35 20 8E BC
A0- 68 0A 24 35 30 05 99 FB
AB- 04 10 03 99 79 04 60 A0
80- 03 B1 48 85 41 A5 AA 85
BE- 3E A0 56 A9 00 85 44 99
C0- FF DB 88 D0 FA 99 00 BB
CE- 88 D0 FA A9 50 20 95 BE
D0- A9 28 85 45 A5 44 20 5A
D8- BE 20 0D 5F A9 08 B0 24
E0- A9 30 8D 78 05 38 CE 78
E8- 05 F0 19 20 44 B9 B0 F5
F0- A5 2D D0 F1 20 DC BB B0
F8- EC E6 44 A5 44 C9 28 90
  
```

TRACK \$00, SECTOR \$8

That's all there is to the first step, but remember that the copy of DOS in the computer is still unchanged, and that this disk contains only the normal number of tracks.

Mark this disk carefully (eg 'Contains altered DOS for INIT'ing \$24 tracks') and boot it; this will load the altered DOS into RAM.

Load any BASIC program you want as the 'startup' program on your new disks, put a blank disk into the drive, and type 'INIT HELLO'.

This will format the new disk, place an image of the new DOS onto it, and prepare the increased number of tracks for storage.

If you want to format any more disks with extra tracks, INIT them now, preferably marking them to show that they contain more than the normal number of tracks.

## Final step

Now we need to perform the final step, altering the information on the new disks to show that they have extra tracks.

Reboot your sector editor and load in Track \$11, sector \$00 of one of your new disks.

Byte \$34 should have the value \$23, the normal number of tracks, so change this to the new number of tracks. Incidentally, the next byte is the number of sectors per track... \$10 equals decimal 16... so don't change this byte.

Looking further down the sector, you should see consecutive pairs of 'FF' and '00' bytes, as in Figure 2.

The 'FF FF' pairs are the 'bit maps' of tracks on the disk, which tell DOS which tracks and sectors are available for storage. The '00 00' pairs are merely separators between the bit maps for each sector.

Naturally, on a disk with files stored on it, some of the bytes will be less than 'FF', but when dealing with a new disk each pair will be 'FF FF', apart from the maps for tracks \$00, \$01, and \$02 (which contain the DOS image) and the map for track \$11.

Sector \$00 of this track contains the VTOC, or Volume Table of Contents, which is on your screen now, and will also store the CATALOG entries once files are stored on the disk.

We need to alter the VTOC bit maps to show that all the new tracks are available for use.

As the bytes after the map for track \$22 are normally all '00', DOS will think they are unavailable even though we told it to look for the increased number of tracks.

Refer to Figure 2 to see which bytes in the editor buffer refer to the new tracks, and change them to 'FF FF' pairs.

When the buffer on screen looks like Figure 3, write Track \$11, sector \$00 back to disk. If you formatted more than 1 disk with your new DOS, write this sector onto each of the new disks in turn.

That completes the process, but there are several points to note.

Firstly, some programs which create files on disk are not able to make use of the extra tracks and will not save to any track numbered greater than \$22.

Secondly, be careful not to alter the bit map for tracks \$00, \$01, \$02, or \$11.

Thirdly, don't expect copy programs to backup your disk unless you are able to specify the full range of tracks to copy. Most bit copiers will cope with track \$23 but no more.

Figure Two:

Track #11, Sector #00: The VTOC

```

00: 04 11 0F 03 00 00 FE 00
08: 00 00 00 00 00 00 00 00
10: 00 00 00 00 00 00 00 00
18: 00 00 00 00 00 00 00 00
20: 00 00 00 00 00 00 00 7A
28: 00 00 00 00 00 00 00 00
30: 12 01 00 00 23 10 00 01
38: 00 00 00 00 00 00 00 00
40: 00 00 00 00 FF FF 00 00 Track #03
48: FF FF 00 00 FF FF 00 00
50: FF FF 00 00 FF FF 00 00
58: FF FF 00 00 FF FF 00 00
60: FF FF 00 00 FF FF 00 00
68: FF FF 00 00 FF FF 00 00
70: FF FF 00 00 FF FF 00 00
78: FF FF 00 00 00 00 00 00 Track #11
80: 3F FF 00 00 FF FF 00 00
88: FF FF 00 00 FF FF 00 00
90: FF FF 00 00 FF FF 00 00
98: FF FF 00 00 FF FF 00 00
A0: FF FF 00 00 FF FF 00 00
AB: FF FF 00 00 FF FF 00 00
B0: FF FF 00 00 FF FF 00 00
B8: FF FF 00 00 FF FF 00 00
C0: FF FF 00 00 00 00 00 00 Track #23
CE: 00 00 00 00 00 00 00 00
D0: 00 00 00 00 00 00 00 00 Track #27
DB: 00 00 00 00 00 00 00 00
E0: 00 00 00 00 00 00 00 00
E8: 00 00 00 00 00 00 00 00
F0: 00 00 00 00 00 00 00 00
FB: 00 00 00 00 00 00 00 00
    
```

Figure Three:

Track #11, Sector #00: The VTOC

```

00: 04 11 0F 03 00 00 FE 00
08: 00 00 00 00 00 00 00 00
10: 00 00 00 00 00 00 00 00
18: 00 00 00 00 00 00 00 00
20: 00 00 00 00 00 00 00 7A
28: 00 00 00 00 00 00 00 00
30: 12 01 00 00 23 10 00 01
38: 00 00 00 00 00 00 00 00
40: 00 00 00 00 FF FF 00 00 Track #03
48: FF FF 00 00 FF FF 00 00
50: FF FF 00 00 FF FF 00 00
58: FF FF 00 00 FF FF 00 00
60: FF FF 00 00 FF FF 00 00
68: FF FF 00 00 FF FF 00 00
70: FF FF 00 00 FF FF 00 00
78: FF FF 00 00 00 00 00 00 Track #11
80: 3F FF 00 00 FF FF 00 00
88: FF FF 00 00 FF FF 00 00
90: FF FF 00 00 FF FF 00 00
98: FF FF 00 00 FF FF 00 00
A0: FF FF 00 00 FF FF 00 00
AB: FF FF 00 00 FF FF 00 00
B0: FF FF 00 00 FF FF 00 00
B8: FF FF 00 00 FF FF 00 00
C0: FF FF 00 00 FF FF 00 00 Track #23
C8: FF FF 00 00 FF FF 00 00
D0: FF FF 00 00 FF FF 00 00 Track #27
DB: 00 00 00 00 00 00 00 00
E0: 00 00 00 00 00 00 00 00
E8: 00 00 00 00 00 00 00 00
F0: 00 00 00 00 00 00 00 00
FB: 00 00 00 00 00 00 00 00
    
```

## 4-16K extra

The process completed, you now have a disk with between 4K and 16K extra capacity in which to store BASIC programs or other files. If you really need more, you can alter the bit maps for tracks \$01 and \$02 to 'FF FF' pairs, so that DOS will eventually write over the DOS image on the disk, making it unbootable but capable of storing another 8K of data.

If you have worked through this series of articles so far, you should have developed a familiarity with the way DOS 3.3 works with the disk and be able to confidently alter bytes on a disk (remember, make a backup first!) to customize the disk or salvage damaged or deleted files.

Armed with a sector editor, a little knowledge, and an enquiring mind, you will discover all sorts of interesting ways to 'fiddle' with DOS 3.3 or ProDOS to suit your ends.

Please write and share your discoveries with others!



# Enhanced Apple II

Enhancements to the Apple II line of personal computers include increased storage and memory capacities.

The enhancements include:

- the UniDisk 3.5, a 3 1/2-inch floppy disk drive capable of storing up to 800K of information - more than five times the capacity of Apple's current 5 1/4-inch drives;
- The Apple II Memory Expansion Card, an interface card capable of expanding the Apple II's maximum internal memory to over one megabyte - more than an eight-fold increase over the current 128K maximum.

The new 800K disk drive bridges the

storage and speed gap between Apple's low-end 143K floppy disk drives and the high-capacity 10mb Apple ProFile hard disk.

The extra memory could be used as an internal "RAM disk", allowing programmes to be directly loaded and executed in the computer's internal memory. The extra memory could also be used for more data space.

An obvious option is MouseDesk, a programme selector allowing several software programmes to be stored at once on either the UniDisk 3.5, Profile or the Memory Expansion Card.

With a desktop interface similar to Macintosh Finder, MouseDesk provides icon-based control for handling multiple programmes and files, using mouse or keyboard.

With existing Apple II software there can be compatibility problems.

The Apple IIc requires a modification (by dealers) to its internal disk control firmware in order to work with UniDisk 3.5.

## Test drive

The Apple Macintosh is on the road again, being offered with appropriate software on overnight loan to potential buyers willing to "test drive" the machine. The offer ends July 31.



# Atari disk drives and DOS's

by Savern Reweti

After years of frustration, lost programs and bad loads you have finally gone out and bought a disk drive.

There's no doubt that disk drives are comparatively fast and have more useful storage capabilities – but they are not foolproof. There has been many a long night I've spent trying to recover lost or erased files.

Before you discard that trusty cassette recorder, bear in mind that it still has its uses.

First, you need to copy your cassette library onto disk.

Also, disks cost more than tapes, and it is surprising how soon you will fill the discs – so back up your disks by copying new programs back to cassette and then storing them away in a cupboard.

If a disk does get accidentally erased or damaged, you have a back-up on cassette.

It may be time consuming but it is better than wasting valuable disk space with back-ups.

## Drive options

There are many disk drives that will work for Atari computers. The most common one is the 1050 Disk Drive.

Older computer buffs may have a 810, which was the first from Atari.

Third-party manufacturers produce single or double density drives; many of the latter based on the 815 format – a drive Atari intended to release, but didn't.

| Drive models –      | 810<br>(Single<br>Density) | 1050<br>(Enhanced<br>Density) | 815 Format<br>(Double<br>Density) |
|---------------------|----------------------------|-------------------------------|-----------------------------------|
| Sectors Per Track – | 18                         | 26                            | 18                                |
| Bytes per Sector –  | 128                        | 128                           | 256                               |
| Sectors per Disk –  | 720                        | 1040                          | 720                               |
| Capacity –          | 92K                        | 133K                          | 184K                              |

Both the 1050 and 815 format drives (eg Rana, Astra, Indus GT) can emulate

the 810 format. But apart from that the different drives are incompatible.

A summary of Atari disk drive specifications follows:

Of course we now have a disk drive but we require Disk Operating System (DOS) software to run it.

The most widely used is **DOS 2.0**, introduced in 1980. DOS 2.0s can read both 810 and 815 disks.

When Atari launched the 1050 drive they brought out **DOS 3.0**.

However DOS 3.0 turned out to be a lemon, and had a number of serious flaws. For example, you could convert all of your DOS 2.0 files to DOS 3.0 but you couldn't convert them back.

Also its memory storage was wasteful and bugs frequently appeared in the operating system.

If you are using DOS 3.0, my advice is to abandon it.

Another Atari-born successor to DOS 2.0 was **DOS 2.5**, which utilises the "enhanced density" mode of the 1050 drive and provides 43% more capacity than DOS 2.0.

There are a variety of separately developed DOS systems for the Atari which I briefly describe below:

**DOS XL 2.3** – supports single and true double density, extrinsic and intrinsic commands, many special features.

**SMARTDOS** – extra menu additions, drive speed checking, bad sector testing, drive reconfiguration.

**SPARTOS** – used in conjunction with ICD Doubler (converts 1050 disk drive into true double density), also runs different drives simultaneously (ie 8", 5 1/4").

**MYDOS** – preserves best features of DOS 2.0 and SpartaDOS.

**TOPDOS** – friendly, easy commands, customizing options.

Finally, the DOS system I recommend is **DOS 2.5**, used in conjunction with **DISKI PLUS**.

Diskio Plus is a DOS utility published by Antic and it replaces the DOS 2.5 DUP. SYS.

I find Diskio Plus an excellent utility and it is very user friendly.

In my opinion this DOS package is the best one for the home computer programmer.

## Microworlds — Tales of the Computer Age.

Edited by Thomas F. Monteleone

UK edition published by Severn House Publishers, 1985.

NZ agent: Hutchison Group Ltd.  
192pp hardcover. Retail \$31.95.

This is a collection of 18 science fiction stories by 18 famous SF authors around the theme of computers.

Only seven were published before 1981 and include such well-known delights as 'The Nine Billion Names of God' by Arthur C. Clarke (1953) and 'Computers Don't Argue' by Gordon R. Dickson (1965).

I thoroughly enjoyed this collection which ranged from the horror of 'Copyright Infringement' by David Bischoff to the philosophical 'The Last Question' by Isaac Asimov.

An ideal present for an SF/computer buff or for a library collection.

— Peter Biggs

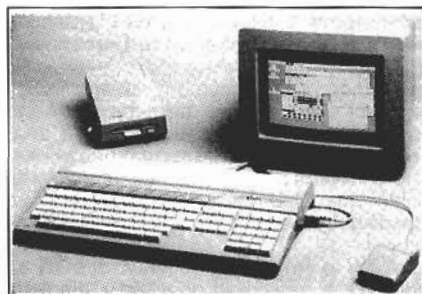

ATARI 520 ST

\*

**SURPRISE**

See Inside  
Front Cover

### Why are companies like MicroPro (creators of WORDSTAR) switching to MODULA-2?

Because they no longer 'C' any alternatives.

Discover why for yourself with one of these well proven compilers:  
HOCHSTRASSER Z80/CP/M \$320  
LOGITECH 8086/PC-DOS/MS-DOS/CPM-86/CCP/M-86, (IBM-PC/XT/AT and compatibles):

BLS (Basic Language System, requires 256K RAM) \$250

BLS/8087 (BLS with 8087 support) \$360

BLS/512K (requires 512K RAM, 80186/80286 code generation option) \$490

Debugger, Editor, Library sources, ROM package also available.

**TECHNOLOGY SOLUTIONS**  
COMPUTER ENGINEERS

Union Centre Building, 107 Armagh Street,  
P.O. Box 13-491, CHRISTCHURCH. PHONE (03) 792-455.

# Ink routine and others

By Graeme Fleming

This month I have a short routine which changes all the characters on the screen to a specified colour – lets call it the ink routine.

**Program one** is the BASIC loader. This can be added to the start of your programs as it is or saved by last months program using C200 as the first address and C216 as the last. If you use the latter method simply run program one first, new it, load the saver program, then use the above addresses.

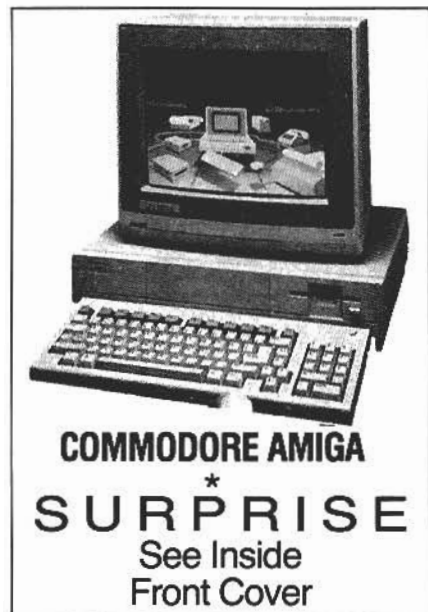

You may notice that this is easier than it was with the auto-run routine, but this program doesn't sit in the cassette buffer.

To use the ink routine first poke the colour, to which you wish to change everything, into location 49665 (ie. POKE 49665,6 for blue) then SYS 49964. Because it is in a different part of memory to your BASIC programs, they can be in memory at the same time, meaning that you can SYS this routine from the BASIC.

Underneath program one there is something which may or may not be totally foreign to you. It is the **assembly language listing** of the ink routine. The leftmost column of numbers are the memory addresses where the command is held, in base 16 (see September scrawl). The next three columns are the numbers held in these and finally commands these numbers stand for.

**Program three** is a use for the ink routine apart from the obvious. As an exercise try adding sound (okay, don't then).

**Program four** sorts words into alphabetical order. First of all you enter the number of words you have to unjumble, then enter them in one by one, pressing return after each. Note the method used in line 70, the <= can be changed to >= for a different result.

If you wish to be able to enter longer words, add more spaces to line 30.

**Program five** prints out a copy on a printer, if you have one. I advise you to

save this one, as you may use it more than you think.

## Joysticks

With a large number of joysticks available, I am sometimes asked "Which one should I get?"

It comes down to how much you are willing to pay.

Wico are the top. With metal mechanisms and the like they never die – but you may when you see the price!

For places where they see a lot of hard use, Wico is the only choice.

The best 'value for money' sticks available, in my opinion, are in the Spectravideo Quickshot range.

I have a Mark One from the earlier VIC 20 days, which still performs well. To accompany this I purchased a Mark Two (which features a rapid auto-fire) early this year, and I have had trouble with one of the fire buttons.

An investigation showed moisture in the micro-switch.

However, I do know people who have had very poor runs out of Quickshots; so remember, it cannot stand rough treatment.

A Mark Two can be purchased for \$24.95.

Also in the range is a Mark Three with a numeric keypad for certain games machines, a Mark Four with interchangeable handles (of dubious value) and a Mark Five with a large fire button.

READY.

```
5 REM *** PRO ONE ***
10 FORA=49664 TO 49685:PEHOB=T+T*B:POKER,B:NEXT
20 IF T<3725 THEN PRINT "ERROR IN DATA" LIST END
30 DATA 109,0,100,0,153,0,216,153,250,216,153
40 DATA 244,217,153,238,218,200,152,250,208,239,95
```

READY.

```
DC200
JC200 A9 00 LDA ##00
JC202 A0 00 LDY ##00
JC204 99 00 08 STA #0800,Y
JC207 99 08 08 STA #08FA,Y
JC209 99 F4 09 STA #09FA,Y
JC20D 99 EE DA STA #DAEE,Y
JC210 08 INY
JC211 06 FA CPY ##FA
JC213 00 EF BNE #C204
JC215 69 RTS
```

```
5 REM *** PRO THREE ***
10 FORA=0 TO 15:POKE 49665,A:SYS 49664:NEXT:POKE 49665,0:SYS 49664
```

READY.

```
5 REM *** PRO FOUR ***
10 0=1:Y=5:Y=5
20 INPUT "NUMBER OF WORDS: ";N
```

```
30 DIMA$(N+X):FORL=1 TO N+X:A$(L)="":NEXT
40 FORT=Y TO N+X-0
50 INPUTD$:A$(Y)=D$:Y=Y+0:NEXT
60 FORB=X TO Y-0:FORC=B+0 TO Y-0
70 IF A$(B)<A$(C) THEN S0
80 D=A$(B):A$(B)=A$(C):A$(C)=D
90 NEXT:NEXT
100 FORB=X TO Y-0:PRINTB-X+0:A$(B):NEXT
```

READY.

```
BITS & BYTES SORT
1 AND
2 BITS
3 BY
4 BYTES
5 G FLEMING
6 SORT
```

```
5 REM *** PRO FIVE ***
10 0=1:Y=5:Y=5
20 INPUT "NUMBER OF WORDS: ";N
30 DIMA$(N+X):FORL=1 TO N+X:A$(L)="":NEXT
40 FORT=Y TO N+X-0
50 INPUTD$:A$(Y)=D$:Y=Y+0:NEXT
60 FORB=X TO Y-0:FORC=B+0 TO Y-0
70 IF A$(B)<A$(C) THEN S0
80 D=A$(B):A$(B)=A$(C):A$(C)=D
90 NEXT:NEXT
100 OPEN#1,4:PRINT#1,"BITS & BYTES SORT"
110 FORB=X TO Y-0:PRINT#1,B-X+0:A$(B):NEXT
120 PRINT#1:CLOSE#1
```

READY.



# Computer games for primary classes

by Andrew Mitchell

What a New Year surprise! Nine new items of software, all educational, having a total of twelve programmes between them (for the C64).

The first bunch, available from Alpine Computing, are from that excellent publishing house MIRRORSOFT.

## Word Games With Mr Men

There are two programmes in this package — Mr Noisy's Word Game, and Read with Mr Bounce.

The Word Game is a way of introducing young children to reading, and goes on to opposites, comparatives, and superlatives using memory and judgement.

Now that may sound a lot, and it is, but there is a menu of 9 options from which you can go to the topic and level of your choice.

Read with Mr Bounce is the next stage, with the introduction of more words and a different concept of teaching to that of the first programme.

Once again there is a main menu this time offering 5 options. The first programme is said to be for 5 — 8 yrs and the second when your child has mastered most of the first, and I would say they have judged the age groupings well.

Both programmes play well, and make good use of colours and reasonable use of sound. There are rewards and incentives built in and it uses a familiar group of characters.

The only criticism would be that sometimes the reaction of the computer to the keyboard is a little slow.

## Look Sharp!

Another two-programme package, for two age groups; the first is Old MacDonald's Farm, a delightful programme, which itself has three options and is for 4 — 7 years.

Options are memory encouragement by the requirement to reconstruct a four picture layout of farm animals. If a part is chosen wrong then the whole picture is redisplayed and the choices start again.

Second is an Odd-One-Out game which is exactly that, good for encouraging observation.

Third is Snap using pictures of the farm animals, which can be played against the computer or another player. There is musical accompaniment and a reward incentive. A really good programme for the target age group.

The other programme is called S.O.R.T. and is for 7 yrs upwards. (It stands for Space Observer Recruitment Test).

This also has several options, a fairly fast comparisons test, an odd-one-out (quite difficult) test and a "build up the picture" as in the younger version except that here there are nine parts to the picture.

You can practise each of the above at slow speed and at "actual test" speed. The

actual test is a combination of all three and was fairly daunting to me.

One of the incentives throughout this programme is to try and launch a rocket ship with your correct answers before the computer launches one with your wrong answers. Another good package.

## Count With Oliver

Another two for the price of one, and the age breakdown is again 4 — 7 yrs and then upwards.

The task is to respond to Oliver's questions by counting the items requested. Sometimes the request is by colour, sometimes by shape.

The task gradually gets harder as both colours and shapes get mixed. This is the younger programme.

The older one is similar but the levels are more complex and now include addition and subtraction.

In both options, if the answer given is wrong then the items requested flash and the question is asked again.

There is a picture of Oliver who smiles for a right answer and blushes for a wrong answer.

The criticism of this programme is the awful "music". I think it's supposed to be "Girls and Boys Come Out To Play", but it sounds as though the BBC Radiophonic Workshop has got hold of it, worked on it and played it at the wrong speed.

The upper age limit on the first programme is probably a little high, as my 4½ yr old had no trouble playing this game to its conclusion.

A good programme to introduce counting and simple math.

## Caesar's Travels

This has been my daughter's favourite programme (age 4½) since we got it about six months ago. My 2½ yr old also loves it and there were often fights at the keyboard until we introduced a strict 'turn' system.

Basically it is an adventure game for young children.

Caesar is a cat who has a series of adventures directed by the operator.

The top two thirds of the screen is simple text, while the remainder is a graphic display of the action chosen. Each phase of the action ends with a two-choice question which the operator responds to by pressing the appropriate function key. There is a function key overlay with the commands pointing to the correct keys.

My daughter needs only a reader to play the adventure, she can operate the rest.

In addition to the reading (for older children), there are also colour, shape, number, and direction problems.

This is definitely the best reading

programme I have come across.

## Caesar the Cat

This is an arcade style game which features the cat from the previous programme, and I think it came first in the order of things.

It is pantry scene where the cat is trying to catch mice while avoiding the occasional item of crockery that will fall if a jump is attempted from the particular position it is sitting on. A bit of fun especially if you have the previous programme. Of limited potential on its own, but one of the better games for younger players.

That's all from Mirrorsoft — before you buy however, make sure you have seen your prospective purchase run. In this field of programmes it's more important to get the programme appropriate for the intended use.

Also reviewed is this selection from Blackwood Gayle Distributors:

## Snooper Troops

(Case #1 — The Granite Point Ghost) from Spinnaker. Ages 10 — adult.

What an interesting programme. It's an adventure game, deduction game, and investigation game with graphics thrown in.

The idea is to solve the mystery of who has been making scary noises at an old mansion house recently purchased by some out-of-towners.

You are given a list of suspects, a few of their personal details and a notebook which has a few suggestions on how to gather evidence, and which has ample room in which to write the information and clues as note.



**COMPUTERS  
FOR PEOPLE**



**SANYO MBC**  
**SALES AND SUPPORT**

35 Taranaki St, Wellington  
Phone (04) 859-675

407 Queen St, Auckland  
Phone (09) 393-408

There are a number of ways to gather information — including breaking into the suspects' houses! I won't say too much more as it may spoil it all.

This programme could be used by a family to work it out together; it was also suggested to me that in the classroom it could be used by groups of students as a competitive activity — groups against each other.

This would add another aspect to the learning features of this programme. At \$49.95 it's not too expensive considering the quality and versatility.

The rest from B.G.D. are all Fisher-Price products and knowing their reputation in the toy field is well earned, I looked forward to reviewing these three cartridges at \$39.95 each.

## Memory Manor

Probably the best of this bunch, for ages 4 — 8 yrs, although probably a little optimistic at the lower end.



## Speedy developer

BOS NZ Ltd, selling multi-user systems software, recently demonstrated Speedbuilder, a programme developer, and Speedbase, a network database manager.

The two combine as a programmer's "shorthand" and speed development of commercial BOS software.

You are presented with a multi-storied building with many windows. In some of the windows are prizes, in a couple a frowning face, the rest blank.

You have the opportunity to fill buckets with water but you are not able to fill all the buckets that are available.

A cloudburst then strikes the building and covers all the windows with a dirty film. The task is to clean the windows that have a prize behind them.

## Logic Levels

This is a maze (for ages 7 — 12 years) through which a ball will eventually roll. The task is to set up various barriers, springs and paint pots so that the rolling ball rolls over all of the prizes distributed throughout the maze.

## Linking Logic

Basically the same as the previous programme, except this is for 4 — 8 yrs. Instead of a ball there is Buddy or Betty who walks through a building picking up tiles which will complete the bottom floor.

As difficulty progresses there are tiles which can be ignored as they are not required; it can be difficult to spot which to leave and which to take.

My comments are similar for each of these programmes.

Firstly, the supporting instructions should be better in each case. As there are no screen instructions, unlike the MIRRORSOFT collection, you are dependent on the written word — and they should be fuller.

Secondly, the graphics are rather

blocky, and the joystick control is sluggish.

Lastly, the games themselves are not inspiring and the reward incentive is not sufficient. Not a recommended buy.

I would like to repeat that it is most essential in this area of software to be absolutely sure of what you are buying before you part with your money. Ask for a demo, and if it's refused find out the distributor's name, and let them know how their agents are treating the customers.



## Commodore desertions

Two vice-presidents of Commodore, both involved in marketing the Amiga and C-series, have resigned over "philosophical differences".

Meanwhile Commodore has laid-off 140 staff in the US as part of cost-saving measures.

The company reported a US\$36.7m loss for the first three months of this year.

## Village stores

Computer Village, a Commodore dealer, has opened its sixth store, in Palmerston North.

## Introducing Flip'n'File™ For Storage and Protection Of Diskettes

Sturdy compact design that swings open to an easel-type work station. Secure, dust free protection for 15, 5¼" diskettes. We also stock a full range of diskettes.

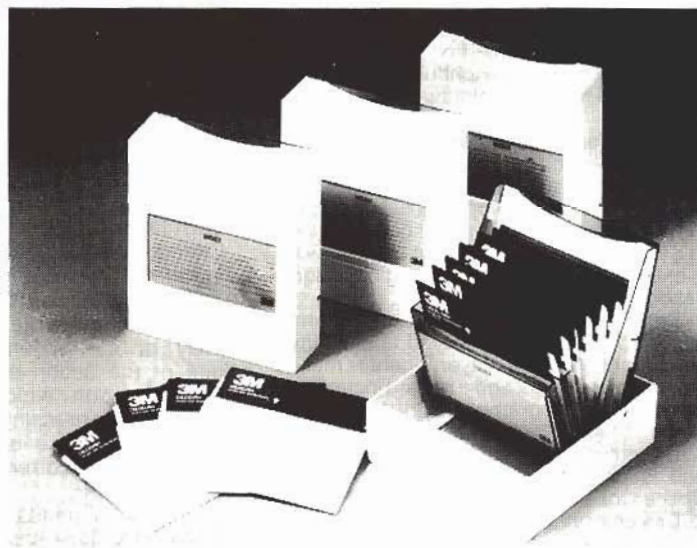

## MAGNETIC MEDIA GROUP

3M New Zealand Ltd. P.O. Box 33246, Takapuna. Ph (09) 444-4760.



# Value that speaks for itself

by Pip Forer

The generation of speech from a computer and the recognition of human speech are areas that have attracted much research.

The commercial applications are obvious. Accurate and flexible speech recognition permits the keyboard to be bypassed, so removing the need for all the incidental skills and restrictions associated with typing.

Executives (or students) could dictate straight to a printer, or could more intuitively control computer monitored devices.

Speech generation allows the computer to avoid the constrictions of using the screen to communicate. It could speak down a telephone or work more effectively with the illiterate. Obviously both aspects have great implications for the unsighted.

## Four options

Until recently both aspects of speech have been expensive and/or unsatisfactory. Over the last couple of years however systems have begun to emerge aimed at the microcomputer market.

The most successful low-cost options have been concerned with making the computer talk.

Four options have been offered. The first two are hardware based: a ROM or card is added to the machine.

In one case this ROM has a vocabulary of specific words. Programming speech consists of instructing the chip which word to produce. The official BBC voice chip used this option, which generally works effectively for the words in the vocabulary, but is not very useful for any other words, unless they are composite of its known words. It is, of course, easy to program.

The other hardware option uses phonemes, specific sounds, which the user must tailor together into a word. This is harder to program, but more flexible.

The problem with hardware systems is that they can be expensive, and to be able to use them in a program you need to feel sure that any machine you want to speak with has the particular hardware modification you need.

Software systems, by contrast, can be tailored to run on any standard model and can be easily installed as and when needed, say across a network. Typically they are loaded into an unused portion of memory and a protocol is provided to activate them.

## Speech!

Software fixes consist of three sorts. Two are parallels to the hardware options. The third, of which no more will be said, works by digitising sound through a microphone and replaying it through a micro's speaker when needed. It gives good quality but is far too memory demanding for small systems.

What one wants, of course, is a cheap, flexible system that is portable, easily programmed and runs on any BBC micro. And Speech! from Superior software comes very close to achieving this.

It is cheap: the disk version retails in the United Kingdom for about £12 (\$31). It is portable: all it needs is 7.5 K of memory somewhere in the machine. It is very easily programmed (it can be made to read this article from floppy disk by any elementary programmer). It is flexible: you can get it either to speak simple English phrases or you can use phonemes.

## 90% accurate

Before lauding it too far let me say what it is, quite reasonably, not. It is not completely accurate in translating normal spelling into speech: it is perhaps 90% successful using a reasonably rigorous criterion.

Getting it to read this column back to

me, it was at fault on about one word in ten. However only 3 or 4 of the thousand or so words here were unintelligible.

Most of the oddities were minor, such as the rather courtly way that the final 'ed' in some words became more prominent. A rather Elizabethan touch, me thinks.

Speech! certainly is not capable of producing a synthesised human voice with all its nuances. At the least however it probably can combine the English text reading skills of an average 10 year old with the intonation of a B grade Byelorussian interpreter. In short, for a minimal cost it is able to pick up the basic requirements needed to implement useful mechanical speech on a micro.

## SAY something

How does Speech! work? It is simple. You \*RUN it from disk.

Once installed it effectively adds several additional star commands to the BBC micro while it is in operation. Of these the two fundamental ones are \*SAY and \*SPEAK.

\*SAY is the simplest to use. Put simply it takes as input any English sentence and speaks it. Thus the line

**\*SAY Power mowers are thoroughly tough though**

has the effect of speaking the sentence correctly. As the example suggests this command can cope with some fairly tricky words, rhubarb and fascist amongst them. Some it does have problems with, for instance chaos and, iron-

## COMPUTER GAMES FOR HIRE

Games available for weekly hire for the following computers:

★ AMSTRAD ★ APPLE  
★ COM 64 ★ VIC 20 ★ BBC  
★ ATARI ★ TRS 80/SYS 80

Send for catalogue and membership details to:

COMPUTER GAME RENTALS LTD  
P.O. BOX 30947, LOWER HUTT.

Name .....

Address .....

Type of Computer .....

## VALUE FOR MONEY

If that's what you're after (and who isn't?), then call us — ANYTIME! (24hr phone)  
We only stock those computers which offer you the best value your dollars can buy,  
backed up by many years of experience in this specialised market.

OUR RANGE CURRENTLY INCLUDES:

AMSTRAD

ATARI

MULTITECH

**KANE AGENCIES LTD**

304A HARDY ST.  
Ph (054) 84-066  
P.O. BOX 710 NELSON

Orders supplied nationwide - FREIGHT FREE. Visa, Bankcard Accepted.



STB Systems, Inc.

TEXAS U.S.A.

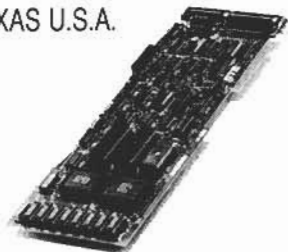

#### HIGH-PERFORMANCE GRAPHICS BOARDS

extend PC/XT/AT to new levels of flicker-free performance.

**\*EGA PLUS** - Enhanced Graphics 640 x 350 full screen color or mono AND 256K display memory AND standard IBM color support PLUS Features Pack listed below. Can support Roland CD-240 monitor.

**\*GRAPHIX+11** - 3 Video outputs: RGB, TTL mono and composite, graphics 640 x 200 colour, 640 x 352 mono, hi-res text, softswitching to appropriate monitor, PLUS Features pack listed below.

**\*CHAUFFEUR** - converts any graphics display to 16-level grey scale mono WITHOUT drivers or software modification. Supports 640 x 200 and 320 x 200 color and 640 x 352 display mode. Provides underline, blink, reverse and hidden attributes. PLUS Features pack listed below.

**\*SUPER RES 400** - 640 x 400 and 320 x 400 graphics. Also supports standard 320 x 200 and 640 x 200 graphics with double scan to enhance definition. Hor. scan 25kHz with switchable polarity, dual-port Video RAM deletes snow and flicker. With PC Accelerator. Supports many monitors, especially Roland CD-240.

**FEATURES PACK** included on most STB boards: Light-Pen interface. Parallel printer port. PC Accelerator software (provides up to 10 RAM-disks and 3 print buffers), optional clock/calendar.

STB Boards all come with advanced programming manual. They are ideal companions for ROLAND Hi-definition Monitors.

NZ Distributors:

**Roland DG**

Concord Communications Ltd.,  
9 Nugent St.  
Grafton, Auckland 1.  
P.O. Box 36-045,  
Phone (09) 398-715.

BBC

ically, Dalek.

Its success is good-enough-though that a program is provided that will adequately read any text file from disk for you.

### Raising the tone!

Some punctuation can be used to get additional effects. A question mark raises the tone at the end of the sentence, a full stop drops it. A comma gives a pause. You can alter the overall pitch of the voice using \*PITCH as a command. You can not control (on this version at least) speed or volume.

You can however pass the string to be spoken to \*SAY using the OSCLI call (the command line interpreter). This means that it is remarkably easy to use remarks already loaded into a string array or input by a user from the keyboard. Any normal text can be used.

Finally \*SAY works from a rule base that checks specific pronunciation rules via a dictionary. This dictionary can be easily improved or modified (although inadequate documentation is given on precisely how to achieve this). All in all, \*SAY is a very powerful option.

### SPEAK-a-da-'talian?

\*SPEAK works differently. It allows you access to 49 phonemes.

Using these you can get greater control of expression and pitch, for instance to produce a rising shriek of Heeeeelp or to give the Beeb a French accent.

With \*SPEAK you can control the spoken output much more closely, at the cost of losing simple access for using text strings.

The package is nicely rounded out by some useful demo programs and programs to relocate the utility to any memory location. There is also an option to place it into sideways RAM, offering access to the utility from any language environment. Want a talking turtle in Logo? You've just got it.

### Simply stated

Within the limitations you might expect of a low cost system Speech! is an excellent piece of software. It won't get your micro singing an aria like Dame Kiri, but it is so simple to use it invites being built into your programs.

At the price it deserves to be bought, not pirated. No one could claim that this company is ripping off its customers.

It works on the Master as well as the model B. Only limitation is that it will clash with anything using the space at &900 and &A00 on either model.

I have only one regret. The mandatory drop in tone caused by a full stop means

that when you replay your literary masterpieces from a word-processed file each sentence ends on a depressing down-beat. Marvin, the metal companion of Zaphod Beeblebrox, has at last found a soul mate.

\* \* \* \* \*

### Network medal

Econet continues to impress and deserve praise as a low cost network.

Anyone contemplating a hard disk file server (or running two file servers on a single network) will be pleased to know that the \*FS command works extremely well with more than one file server present, keeping users logged in to multiple file servers simultaneously.

The NETNET utility for transferring files between network file servers (for archiving or when moving to hard disk) is also extremely effective in operation.

### CAI for small business management.

The Small Business Agency, a division of Development Finance Corporation, has established a new computer-aided training service as an extension of its advisory and education services for small business.

Its clients will be able to choose from 10 different training applications depending on their particular needs.

Four are in the vital financial management field. They offer self-teaching to increase the business operator's understanding of such critical factors as financial accounts, the significance of financial ratios (and how to read the warning signs), case flow forecasting and measuring specific business performances.

The training is specially designed to give the small business manager the ability to apply the information directly to his or her own activity.

The six business management courses, or modules, will make small business operators more skilled in managing themselves and their staff by providing training in such areas as personal time management and defining goals and objectives.

Computer-aided training clients will be given a free introductory session on the equipment with an SBA counsellor.

After that, the client will be able to use the equipment to train on at a pace that he or she find suitable. The equipment can be used to solve problems or help plan the client's own business activity as the training is mastered.





# Viewing a 3-D house

by Dick Williams

Last month I introduced the subject of matrix transformations for 3D drawing and this month I have a follow on to that with a short demonstration program drawing a house in wire form.

The program contains some complicated mathematics to key in and I suggest you do one section and save it, then do the next section and save again. The program draws a four sided house with a pitched roof in wire form, that is just lines connecting up the corner points and having drawn it; allows you to move around the house and to move over the house and shows the house from the new position that you are looking from.

The time to calculate the new points and redraw is about 8 seconds. The time factor is not so important; what is important is that if you take the trouble to key this program in and get it running you will see a very simple example of viewing an object from different viewpoints, and gain an understanding of how this is used in industry.

It's probably not all that important to understand the mathematics because this is covered in more detail by others in maths text books.

There are 30 co-ordinates for the house points (10 X, 10 Y, 10 Z) and 17 lines required to join these points up in the correct order.

Lines 10-30 set up the graph screen and the variables A and B, which are used to set the screen printing position for prompts and messages.

Lines 40-90 dimension the variables.

Lines 100-290 read the data and lines 220-240 set the house size on screen. This can be altered by changing the multiplier (50) to anywhere between 25 and 75.

The next section (lines 300-440) receives your instructions from the cursor keys and either redraws the image in its new position or if you get lost, will go back to the beginning and draw the image afresh. The left/right arrow keys move you round the house and the up/down keys move you over or under it.

The numbers shown on screen only serve to give you an arbitrary position fix, so if you like a particular viewpoint you can note the x and y numbers and return to it.

Lines 450-750 take the sin and cos of the viewpoint angle and set up further variables and the 3 co-ordinates x(p), y(p) and z(p) are changed into 2 screen co-ordinates x(p) and y(p).

Lines 760-800 changes these into a(p) and b(p) and, as mentioned last

month, divided by W to finish the conversion to 2 screen co-ordinates.

Lines 810-850 does the actual drawing on screen and as you can see is only a very small part of the program.

I have laid the program out in a straight line manner, ie. each part follows on from the one before so that you can get a better idea of the steps involved, and have left spaces between each of the sections and spread some of the more complicated maths out a bit for easier reading.

You don't need to leave these spaces in (leave the ones between text inside speech marks) but you will find it useful to type the rem lines to keep your typing error free.

Be careful because one wrong line can be very hard to find.

In lines 690 and 700 the character that looks like a vee(v) or a ewe(u) is a vee. The variable in lines 300,310 and 840 is D (dee).

```
10 REM 3 D
20 SCREEN 2,2:A=20:B=100:CLS:ERASE
30 REM -----
```

```
40 TH=P1/4 : PH=P1/180*35
50 R=500
60 XC=500 : YC=500 : ZC=-2000
70 DIM A(20) , B(20) , X(20)
80 DIM Y(20) , Z(20) , S(20) , F(20)
90 REM -----
```

```
100 RESTORE :A$=""
110 DATA 0,0,0,0,0,2,0,1,0,0,1,2
120 DATA 1,0,0,1,0,2,1,1,0,1,1,2
130 REM -----
140 DATA .5 , 1.5 , 2 , .5 , 1.5 , 0
150 REM -----
160 DATA 0,4,4,6,6,2,2,0,1,5,5,7,7,3
170 DATA 3,1,0,1,4,5,6,7,2,3,2,9,3,8
180 DATA 7,8,6,9,9,8
190 REM -----
200 P=10:L=17 :FOR P=0 TO 9
210 READ X(P),Y(P),Z(P)
```

```
220 X(P)=X(P)*50
230 Y(P)=Y(P)*50
240 Z(P)=Z(P)*50 :NEXT
250 REM -----
260 X(P)=0:Y(P)=1:Z(P)=0:P=11
270 REM -----
280 FOR L=0 TO 16
290 READ S(L),F(L):NEXT:REM -----
```

HIGH QUALITY

## BINDERS! for BITS & BYTES

We now have available binders to hold your copies of BITS & BYTES. We have opted for the same type of binder used last year (pictured) as these provide high quality protection in an attractive finish.

These are available in two styles.

STYLE 1: With the words "BITS & BYTES, VOL 3, September 1984 - August 1985".  
(For those who have a complete volume.)

STYLE 2: With the words "BITS & BYTES" only.  
(For recent subscribers or those with a mixture of volumes)

Each Binder holds 11 magazines

**Order now as stocks are limited!!**

**Please use the book club order form in the centre of the magazine and be sure to note which style of wording you require.**

**Cost: \$17.95 per binder**

```

300 CURSOR A,B
310 IF D=0 THEN PRINT "PLEASE WAIT"
320 IF D=0 THEN 450
330 GOTO 400
340 A$=INKEY$ :IF A$="" THEN 340
350 IF A$=CHR$(28) THEN TH=TH-P/20
360 IF A$=CHR$(29) THEN TH=TH+P/20
370 IF A$=CHR$(30) THEN PH=PH+P/20
380 IF A$=CHR$(31) THEN PH=PH-P/20
390 REM -----
400 CURSOR A,B:PRINTCHR$(S);"X=";INT(T
HX*20);" Y=";INT(LPH*20);" N=NEW D=OR
IGINAL
410 IF A$="D" THEN D=0:GOTO 10
420 IF A$="N" THEN 440
430 GOTO 340
440 CURSOR A,B:PRINT CHR$(S);"NEWDRAW"

```

```

450 CT=COS(TH) :ST=SIN(TH)
460 CP=COS(PH) :SP=SIN(PH)
470 TX= -(CX+R*CP*CT)
480 TY= -(CY+R*SP)
490 TZ= -(CZ+R*CP*ST)
500 CX= -CP*ST+SQR(SP*SP*CP*CP*ST*ST)
510 SX= -SP+SQR(SP*SP*CP*CP*ST*ST)
520 CY= +SQR(SP*SP*CP*CP*ST*ST)
530 SY= -CP*ST
540 REM-----

```

```

550 FOR P=0 TO 10
560 IF P=10 THEN 600
570 X(P)=X(P)+TX
580 Y(P)=Y(P)+TY
590 Z(P)=Z(P)+TZ

```

```

600 X=X(P)
610 Y=Y(P)*CX+Z(P)*SX
620 Z=Y(P)*SX+Z(P)*CX
630 X(P)=X:Y(P)=Y:Z(P)=Z
640 X=X(P)*CY+Z(P)*SY
650 Y=Y(P)
660 Z=X(P)*SY+Z(P)*CY
670 X(P)=X:Y(P)=Y:Z(P)=Z
680 NEXT :REM -----
690 U=SQR(X(P-1)*X(P-1)+Y(P-1)*Y(P-1))
700 C=Y(P-1)/U : S=X(P-1)/U
710 FOR P=0 TO 9

```

```

720 X=X(P) * C -Y(P) * S
730 Y=X(P) * S +Y(P) * C
750 NEXT :REM-----
760 FOR P=0 TO 10
770 A(P)= -X(P) * ZC + Z(P) * XC
780 B(P)= -Y(P) * ZC + Z(P) * YC
790 W=Z(P)-ZC
800 O(P)=A(P)/W :B(P)=B(P)/W:NEXT:REM-
810 CLS : FOR P=0 TO 16
820 S=S(P) : F=F(P)
830 LINE(A(S),B(S)) - (A(F),B(F)),1
840 NEXT :D=1
850 GOTO 100 : REM -----

```

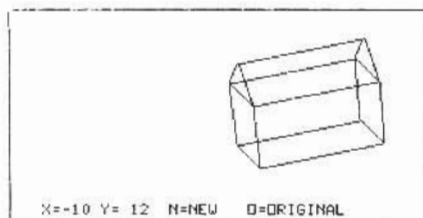
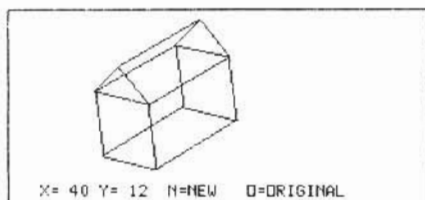
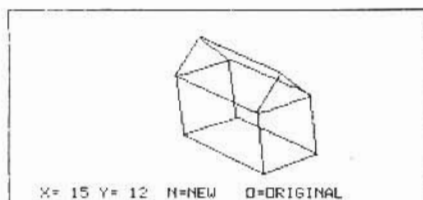



## MICRO SOFTWARE HIRE CLUB

OPEN WEEKDAYS & SATURDAY MORNINGS

### Commodore VIC20 & 64 – AMSTRAD

### ATARI – BBC – SPECTRUM – ELECTRON

☆☆ BRANCHES ☆☆

**AUCKLAND**  
C B CENTRE PH 444-8063  
15A Porana Rd., Takapuna  
THE COMPUTER TERMINAL PH 419-0543  
257 Hinemoa St., Birkenhead  
ABACUS VIDEO CENTRE PH 864-151  
16 New Bond St., Kingsland  
K ROAD COMPUTERS PH 399-655  
65 Pitt Street  
**MANUKAU COMPUTERS (NZ) LTD PH 658-002**  
Greenwoods Corner, Epsom  
**SOUTH AUCKLAND COMPUTERS PH 299-6030**  
214 Gt. South Rd., Papakura

**ROTORUA**  
CHANNEL FIVE PH 89-164  
87 Fenton Street

**NORTHLAND**  
GARNET KEENE PH 84-999  
36-40 Rathbone St., Whangarei

**TAUPO**  
Kiwi Computer Services Ph (074) 83-028  
C/- Terrys Tyre Services Runanga Street

**WAIKATO**  
COMPUTER ROOM LTD PH 437-876  
177 Ward St., Hamilton

**GISBORNE**  
PERSONAL & BUSINESS COMPUTERS LTD  
PH 88-256 115 Gladstone Road  
**NEW PLYMOUTH**  
TRIO BUSINESS CENTRE LTD PH 85-226  
635 Devon Road

**TOKOROA**  
AUDIO PH SERVICES LTD PH 68-922  
Dreghorn Place

**HAWKES BAY**  
COMPUTER CONNECTION PH 51 965  
18 Dalton St. Napier

**GREYMOUTH**  
Centrepoint Records  
Mackay Street  
Greyouth Ph 5956

**DARGAVILLE**  
D & J Computers  
Victoria St.

**DUNEDIN**  
Eclipse Radio & Computers  
134-136 Stewart St  
Ph 778 102

☆☆ Trade enquiries welcome ☆☆

A Branch Franchise may be available in your area.  
Please Contact Phone 444-8063 or write  
Box 33-196 Takapuna, Auckland.

**Mail Order other than through Clubs –**

**NORTH ISLAND**  
Kiwi Computer Services  
P.O. Box 822  
Taupo Ph (074) 83-028

**SOUTH ISLAND**  
Centrepoint Records  
Mackay Street  
Greyouth Ph 5956

## Framework start-up

"FRAMEWORK; An Introduction", by Bill Harrison, published by Ashton-Tate, \$39.90

The creation of a software instruction manual must be a thankless job. While adequately displaying the sophistication and power of the software it is describing, it must attempt to cater for the purchaser who is using a computer for the first time and who is having real difficulty understanding the operation of the NUMLOCK key.

This particular book is written for such a person and does quite a decent job of explaining a complicated package.

Although the book itself is large, the size of the typeface and the number of illustrations only leaves room for a medium helping of text. In a book pitched at beginning users, this is probably not a bad thing.

Two production features tend to detract from the book's appearance. Every page has large black stripes across the top and bottom which makes the whole thing feel slightly satanic, and the quality of the screen dumps is very poor.

Having a variety of books which tackle the same subject at different levels of difficulty is not a new concept... look at the 3672 books explaining Apple BASIC... but it is a new development for the publisher of the original software to also be directly involved.

Ashton-Tate is producing a series of FRAMEWORK books, and if the quality of subsequent ones matches this introductory work, FRAMEWORK users will be well satisfied.



# What are arrays?

## 'Imagine a shoebox...'

by Gary Parker

I recently received a request to write a column about arrays. The use of arrays and strings in Sinclair Basic is unusual and seems to give many people a bit of trouble, so this month I'll delve into this subject.

Arrays and string arrays are covered in chapter twelve of the Spectrum manual, but chapter twelve is only three pages long and doesn't explain things in much depth.

First of all, what is an array?

At its simplest, an array is simply a set of boxes used to hold numbers. Imagine a shoe shop. A shop assistant has a pair of shoes in his hand, and wants to store them. He puts them in a shoebox. This is like a variable being stored in a piece of a computer's memory.

Now imagine the assistant has ten pairs of shoes. He needs ten boxes to store them. If the boxes are arranged in a row, he can number the boxes 1 to 10, and refer to a box by its number.

So if a pair of brown brogues belongs in the fourth box from the end, the assistant could refer to the box as box (4), and note down "box(4) = brogues" to remind him of the fact.

In the same way, if we have an array of ten "boxes" called b, and we want to put the number 6 into the fourth "box", we can write LET b(4) = 6.

These "boxes" are called elements. The number which tells us which element we are referring to (in this case 4) is called a subscript.

### DIM means...

The computer needs to know how many elements your array is going to have before you attempt to use the array. You do this with the DIM statement.

DIM stands for Dimension; you are specifying the dimensions of the array. For a row of ten elements, we would have to say DIM b(10) to create an array called b with ten elements.

What is in the ten elements before you put any numbers into them? When you create an array with a DIM statement, all the elements are set to hold zero. Try it - set up an array and then print out the contents of any element. The answer will be 0.

Imagine our shop assistant had a great many pairs of shoes and boxes. He might not have enough space to ar-

range the boxes in one long row, so he might have to arrange them into several rows, one below the other, forming a grid of boxes. Then he would have to use two numbers to refer to a particular box - one for the row, and one for the column.

For example, if he wanted to refer to the sixth box in the second row, he could write box(2,6).

Similarly, we can have arrays which are made up of a grid of elements. To put the number 6 into the third box of the second row, we would write LET b(2,6) = 6.

### 3-D grid

Now what could our assistant do if he had still more boxes?

If the grid of boxes was stacked up vertically against a wall, he could stack another grid of boxes in front of that one, and another, and so on, so that he had several boxes deep.

To refer to any particular box he would need three numbers, one for the number of boxes down, one for the number across, and one for the number back. If he wanted to refer to the box 2 down, 6 across, and 3 back, he could write box(2,6,3).

Arrays behave in the same way. You can have a three-dimensional array which requires three subscripts to

specify a particular element. For example if you wanted an array 5 down, 10 across, and 8 deep, you would write DIM b(5,10,8). Then if you wanted to put the number 6 into the element 2 down, 6 across, and 3 back, you would write LET b(2,6,3) = 6.

Incidentally, arrays don't have to be called b. They can be any letter, but only a single letter. So Z is okay but BOX isn't.

A single element of an array also behaves very much like a variable. You can assign the value of other variables into it, and give it the value of other variables, and so on.

There are only three dimensions in the real world. So our assistant can only utilise up, down, and back to store boxes. But in the Spectrum, you can have an array with as many dimensions as you like. So you could write DIM b(3,2,10,6,7,8) if you wanted.

But arrays with lots of dimensions are seldom used. Perhaps this is mainly because they cannot be visualised. You can imagine a three-dimensional array as a block of boxes, but you can't apply a concrete analogy to a four-dimensional array.

As you add more dimensions, an array rapidly becomes large. The one-dimensional array created with DIM b(10) contains, fairly obviously, ten elements. But the six-dimensional array created by the DIM statement in the preceding paragraph contains 7560 elements - multiply the dimension sizes together.

The amount of memory dictates how big an array can be. Each element of an array takes up five bytes. Since you have around 41K available, the most elements you can have is around eight

*the Houston way*

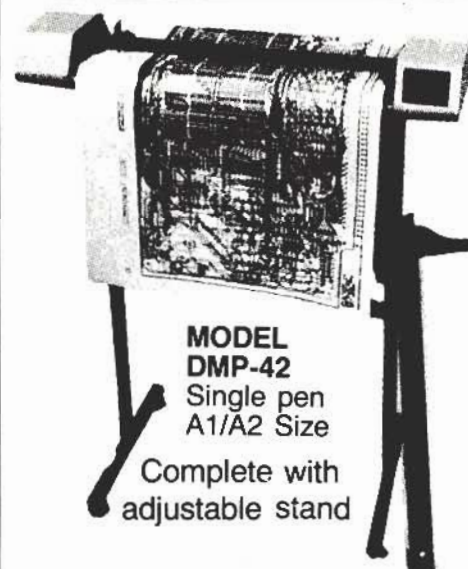

**MODEL DMP-42**  
Single pen  
A1/A2 Size

Complete with adjustable stand

**INTELLIGENT PLOTTERS**

Houston Instrument's DM/PL™ (Digital Micro/Plotter Language) is built into the DMP-42. This means the user has unlimited graphic capabilities. DM/PL enables the DMP-42 plotters to automatically generate curves, arcs, ellipses, and circles of various sizes. Straight and slanted (italic) characters can be drawn to follow any line or angle in 255 different sizes. These plotters draw solid lines, as well as combinations of solids, dots, and dashes. In addition, the user can plot only a portion of a drawing (window) when necessary or scale drawings up or down to suit his graphic needs. All these inherent characteristics make these plotters remarkably "intelligent".

Call NZ Representative for name of your nearest dealer.

**S. D. MANDENO ELECTRONIC EQUIPMENT CO.**  
10 WOODHALL ROAD, EPSOM, AK 3 PH 600-008 TELGRMS NUCLEONIC



thousand. Try it – turn on your computer and do DIM a(9000) as a direct command. It won't fit and you'll get an out of memory error.

Now try DIM a(8000) and it will be accepted. Of course you'll have practically no room for a program, but you can't have everything.

Arrays can hold strings as well as numbers. This is where Sinclair Basic becomes very unusual, but it is very powerful and completely logical. The Spectrum's powerful string handling can make certain programs much easier to write than on computers lacking such facilities.

Imagine you have the string "Sinclair". With an ordinary string, you can alter it to make it as long or as short as you like. But when used in an array,

you must specify how long it is going to be. Say we specify eight characters with DIM b\$(8).

Then if we try to put a longer string such as "Clive Sinclair" into the string, all it holds is "Clive Si" – the first eight characters. Try it. You'll have to dimension the array as above, assign the name to it using LET, and then print out the string array with PRINT b\$.

## More strings

That string array is not really very useful. It is too much like a weak version of an ordinary string. But you can also put lots of strings in a string array. The state-

ment DIM b\$(10,8), for example, would hold ten strings. Each string would hold a maximum of eight characters. So you could put "Sinclair" into the first string with LET b\$(1) = "Sinclair" and "Clive" into the second string with LET b\$(2) = "Clive".

You can also refer to any particular character in a string, simply by adding another subscript. So in the above example, b\$(2,1) would be "C", and b\$(2,3) would be "i". Get it? An array of strings really behaves very much like a two dimensional array.

So what advantages does a string array have over an ordinary array? Well, for one thing, you can process text easily. But I think that the main advantages are memory efficiency and speed.

First of all, let's look at memory efficiency. Each number in an array takes up five bytes. But each character in a string array takes up just one byte. So if you are dealing with single-digit numbers, a string array uses only a fifth of the memory of a number array. Try doing DIM b\$(40000). It works! With an ordinary array, the maximum number you could use was 8000.

From the point of view of speed, a string array is faster to print on to the screen. This is because you can print out a whole string at once, whereas with a normal array you must print out each element in turn. So, for example, if you want to print out "Clive" you need only write PRINT b\$(2), without having to use a loop which prints out each character in turn.

As far as I can recall, Sinclair Basic has the most powerful array and string features of any computer I have used. Even advanced languages on main-frame computers seldom allow limitless numbers of dimensions.

When you are trying to program a particular task involving large numbers of numbers or characters, be sure to think carefully of how you could use these features. They could make the job a lot easier.



**NEPTUNE I, II**  
2.5Kg at 1120mm  
Hydraulic using water



**MENTOR**  
1 Kg at 420mm  
DC servos

**ROBOTS from only \$2000 !**



**WORKCELL COMPONENTS**  
indexing table  
expandable conveyor  
sensors gauges etc

**UK's WIDEST Range of low cost robotic & FMS equipment**



**VICKER ELECTRICAL LTD**  
**P.O. Box 960 Wellington**

**Tel. (04) 856-158 Telex 3311**

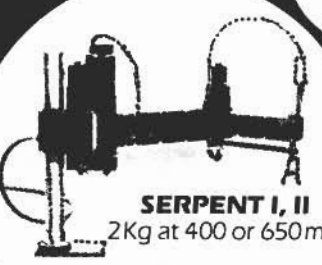

**SERPENT I, II**  
2Kg at 400 or 650mm  
DC servo/pneumatic SCARA

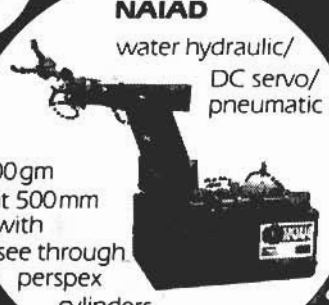

**NAIAD**  
water hydraulic/  
DC servo/  
pneumatic  
500gm at 500mm with see through perspex cylinders



**COMPUTERS FOR PEOPLE**

**AUTOCAD CAD/CAM SALES AND SUPPORT**

35 Taranaki St, Wellington  
Phone (04) 859-675  
407 Queen St, Auckland  
Phone (09) 393-408



# Erasing arrays and wasteful ways

## Saving Space – Part 2

by Don Stanley

Arrays are often only needed for a small part of a program, but frequently they are retained for the entire program.

The ERASE command removes an array and returns any space that it was using, back for use by Basic.

Another space saver for arrays is to always use a DIM statement, even if your array has less than 10 elements.

If your array has only 6 elements and is double precision, then not declaring it in a DIM statement as DIM (name) will waste 32 bytes which are reserved for storage of the remaining 4 elements.

Remember too that array indexes always begin at zero, not one, so if you are in the habit of starting your arrays at element 1, you are wasting the space assigned to element zero.

The CLEAR statement can have a drastic effect on memory. The effects of this statement are not undone by either ENDING a program, nor by NEWing memory.

To return CLEARed memory back to Basic, you need to type CLEAR 200 (the default). By the way of your program uses no strings at all, and no string functions, typing CLEAR 0 will give a further 200 bytes of space.

## LETs out

Many early (and even recent) versions of Basic required a LET statement when assigning values to a variable. SVI/MSX Basic do not require this, and using it is wasting a byte. So if you are converting a program with LETs in it, remove them.

For space saving considerations with the LPRINT command, refer back to the December issue, Page 54 and the OPEN CRT: command.

When branching to one of a large number of possible lines it is preferable to use the ON.. GOTO or ON.. GOSUB commands if possible. The option is IF.. THEN.. ELSE. Compare the following program chunks...

```
(1) 10 X$= INPUT$(1)
    20 IF X$ < "A" OR X$ > "Z" THEN 10
    30 IF X$="A" THEN GOSUB1000
```

```
ELSE IF X$="B" THEN GOSUB1100
ELSE IF.....
```

```
ELSE IF X$="Z" THEN GOSUB
3000
```

```
(2) 10 DEFINT X:X$ = INPUT$(1)
```

```
20 IF X$ < "A" OR X$ > THEN 10
```

```
30 X = ASC(X$) - 64
```

```
40 ON X GOSUB 1000,1100,....,3000
```

The program simply reads an uppercase letter typed at the keyboard, and then goes to a subroutine which is determined by whichever letter was entered.

Program (1) uses what I call brute force, the most obvious and memory gobbling method. It just uses IF/THEN/ELSE to compare X\$ with each letter of the alphabet and jump to the corresponding routine.

Program (2) reduces the character variable X\$ to a numeric variable X by subtracting 64 from X\$'s ascii value. An "A" has an ascii code of 65, so subtracting 64 from ASC(X\$) results in a value between 2 and 26. ("Z" has an ascii code of 90, so subtracting 64 gives 26).

In other words, we have mapped the character with its corresponding position in the alphabet, then used that position in the ON statement to decide where to branch to.

## Achieve More From Your Commodore 128 From COMPUTE! Books.

This guide to the powerful Commodore 128 computer contains a wealth of information for every programmer. Explore BASIC 7.0. Enter the world of CP/M. Learn how to create dazzling graphics and sophisticated sounds in both BASIC and machine language and much more.

\$42.95\*

Some of the best games, applications, and utilities from COMPUTE! Publications for the Commodore 64 and 128 in 64 mode, plus special sections detailing the advanced features of the 128.

An easy-to-use, complete small business/home accounting system that satisfies every accounting need — from income and expenses to property and investments.

COMPUTE!  
COMMODORE  
128  
ULTIMATE  
COLLECTION

\$32.95\*

COMPUTE!  
Personal  
Accounting  
Manager  
for the  
Commodore 64  
and 128

\$32.95\*

Available from leading bookshops. Coming soon — 128 Machine Language for Beginners, COMPUTE!'s Kids and the Commodore 128

## Holt Saunders

Box 22-245, Otahuhu, Auckland Ph: 276 2087

\*Prices quoted are recommended retail only.



Program (1) uses 616 bytes, program (2) requires 246 bytes.

There are other ways of saving space, which require a fairly good knowledge of Basic in order to use. For instance, using a 1 element array instead of variable, then ERASEing the array when you are finished with it; replacing PUT SPRITE with VPOKE (also speeds up sprite handling); using machine code instead of BASIC and a variety of other methods.

Disk users have the option of keeping data on disk rather than in memory. Generally this will slow down program speed, but may allow much larger programs to run, particularly when using random access.

The SVI/MSX disk drives are very fast, and I find using the disk rather than memory very efficient.

As well as saving space, its often of use to speed up programs, particularly where graphics is concerned.

This idea (below) for speeding up the line command was published about a year ago in the Wellington Users Group newsletter but seems to have bypassed many people in other groups.

When drawing a line horizontally, but not diagonally, use a BF on the end. For

instance:

```
LINE (0,30) - (255,30),1
takes 11 interrupts to run in (11/50
second), while
```

```
LINE (0,30) - (255,30),1,BF
takes just 5 interrupts (< 5/50 sec-
ond).
```

You can check how many interrupts are needed and see just how much quicker this method is, with the following program

```
10 SCREEN 1: TIME = 0
20 LINE (0,30) - (255,30),1,BF
30 X = TIME
```

then type ? X in direct mode after running the program. Then remove the ,BF and run again and note the difference.

The method doesn't seem to affect vertical lines, but some people claim it speeds them up as well. Decide for yourself!

Moving away from saving space and whizzing up lines, lets go MSX for a while. In fact, lets go Xpress and in particular, CPM.

CPM as implemented on the Xpress provides a means of getting around the lack of MSX-DOS software at present available. Note, that is MSX-DOS software, not MSX software (which is available in large quantities).

There are some noteworthy features of CPM which users may not be aware.

Firstly Xpress supports up to 9K print spooling under CPM. When you issue a print statement, say from Wordstar, the file is moved into 9k of spare video ram.

SpectraVideo has updated their original CPM - if your Xpress boots CPM and prints INTERNATIONAL KEYBOARD the feature is present, otherwise it appears to not be present.

Secondly, the Xpress supports a number of different disk formats. With only 1 drive (as is standard), you should be able to insert a Bondwell 2 disk, type I: , and then read that disk. With the addition of a second disk drive, connected via the built-in 25 pin second disk port, provided it is a 5.25" drive you can read MSX, Osborne ssdd, Kaypro2, Bondwell 12/14 dsdd, bondwell 12/14 dsdd, SV1328 ssdd and SV1328 dsdd disks. This feature is only available under CPM, and it's an SVI asset, not a MicroSoft feature, so does not appear under MSX-DOS.

The Xpress CPM has a utility called FILECOPY which can transfer software from MSX to CPM. Since MSX-DOS bios calls are similar to CPM (complete specifications are given in the manuals, including where the bios calls differ) applications can be written under CPM (taking care that differences in bios calls are heeded) then transferred to MSX-DOS for testing. This filecopy routine is only available on the Xpress and the SV 728, and makes up somewhat for the lack of software under MSX-DOS, enabling you to write your own assembler software.

For anyone interested in disassembling CPM on the Xpress, here's some useful information.

The 50 times a second interrupt is located from E43B to E539. This includes the printer spooler routines from E4D5 to E426.

Function key definitions are stored from E39B to E43A.

The cold boot code is between E543 and E5CA.

The base of the CCP is CC00.

A warm boot starts at E5CD.

If you want to alter the RS232 code to prevent parity bit stripping, null out bytes EB5C and EB5D (receive) and EB31 and EB32 (send).

The sign on message occurs from F0E5 to F161.

CPM's jump table begins at E200 with the cold boot address.

Software for the Xpress CPM includes all the MicroPro software (Wordstar etc). My versions of Turbo Pascal, DBase 2 and various other CPM programs and utilities all run happily after transferring them from the 328 with an RS232. There's no reason why any standard CPM software shouldn't run, and the built in 80 column capability ensures they run at the screen width they were intended for.

**Your products  
are our  
business. . . lets  
hear about them  
CALL —  
Bits & Bytes  
796-775**





# Arrays and a jump table

by Joe Colquitt

In previous articles, I've tried to explain how loops and simple data storage routines work. These two topics come together when handling arrays.

Because BASIC organises the orderly storage of variables and ML doesn't, it is imperative to keep even the vaguest of notes about which space has been allocated to your ML variables/data.

To start off, try a one-dimensional array, i.e. subscripted variables.

As you know from BASIC, a subscripted variable set is a series of variables with the syntax NAME(ELEMENT).

Using this type of data in ML is quite common, usually to store a set of parameters for a sprite, sound or similar.

Taking sound as an example case, a one-dimensional array can be used to hold all the register contents.

To extract data from this array, only one index register is needed, the data being accessed by the ABSOLUTE, X (or Y) instruction (LDA\$addr,X or Y), and can be similarly despatched to its destination by STA\$addr,X (or Y).

**Routine 1**, with its data, will clear all SID registers. To set the registers, substitute the 0's. One loop can access many different sets of data by changing the loop length the target address or both.

Change \$C000 to LDX\$C00D, and now the loop starts retrieving data from \$C100 indexed by the contents of \$C00D.

You could change \$C005/\$C006 to have a new target address, or \$C008/\$C009 for a new destination address.

It's a bit contrived, but **routine 2** shows the principle. This loop is now self modifying, and will store the contents of \$C100-\$C1FF into \$0400-\$04FF, and the contents of \$C200-\$C2FF into \$D800-\$D8FF.

**Routine 3** sets the elements of an array to random numbers, perhaps for a game, using the output of oscillator 3. To get a different range, change the parameters at \$C00F and \$C013. The 1ms delay allows the oscillator to move on to a new frequency.

If \$EEB3 isn't called, the ML loop runs faster than the oscillator, and so consecutive array elements have the same value.

By using these examples and your imagination, there are countless applications for this sort of routine. To side-track for a moment, here is a bubblesort for arranging a one-dimensional array into descending order.

In **routine 4**, I have used the screen (a valid area of RAM) to store the total array, and it means that you can actually see the program sorting. Use this small BASIC program with it, or an ML equivalent.

A BASIC sort with the same syntax took 23 minutes to do the job. A bit slow for data processing. However, sorts of arrays with less than about a dozen elements can be done in a couple of seconds using BASIC.

## Jump Tables

A Jump Table is a set of word-length (2 byte) addresses arranged as an 'array' which are accessed in pairs by an index.

I suppose it roughly compares to ON X GOTO.. in BASIC. To illustrate, **routine 5** will perform ten different functions, depending on the value (0-9) of an inputted number.

It could be used as part of a menu selection.

The best way to experiment with these sort of routines is in conjunction with a monitor, where you can retain control, but in deference to non-Commodore users and those who have 64's but haven't got a monitor yet, I'll just make the menu JMP to ROM routines. The 'Goto' addresses are at \$C100-, in 6502 format (l/h).

The doubling at C012 is necessary because the addresses are stored in pairs. Number keys 0-9 have CHR\$ values 48-57, so stripping 48 off the k/b queue value means that the number the routine works with is the same as that on the key.

Astute readers will have noticed that the addresses are all \$EAE8, a harmless scrolling routine in ROM. Naturally you put your JMP addresses in their place.

The range of number keys allowable can be set at \$C00E. More on arrays to come.

Anyone who would like a copy of the machine code monitor programme 'Supermon' should send me a disk or cassette and a return envelope. As I have an adjustable datasette, if you can include a small SAVE on your cassette, I can make sure that my SAVE will LOAD on your machine. I'm at: 6 Martin Ave, Mt Albert, Auckland.

### 1. Using a block

```
C000 LDX#10 :no. of elements
C001 LDA#100,X:residing at $....
C005 STA#100,X:destination
C008 DEY
C009 BPL#C00C
C00B RTS
Data (insert values needed)
C100 00 00 00 00 00 00 00 00
C101 00 00 00 00 00 00 00 00
C110 00 00 00 00 00 00 00 00
```

### 2. Shifting a block

```
C000 CLC :use 'carry' as a flag
C001 LDX#100 :set the index
C007 LDA#100,X :perform transfer
C006 STA#100,X
C009 INX
C00A BNE#C00C
C00C BCS#C01C :if carry set, restore loop
C00E LDA#100,X :if not, set new parameters
C00F STA#C005
C017 LDA#100
C015 STA#C00B
C018 SEC
C019 JMP#C001
C01C LDA#101
C01E STA#C005
C01F LDA#104
C013 STA#C00B
C016 RTS
```

### 3. Random number array (#20-#30)

```
C000 LDX#100 :set osc 1 to noise
C002 STA#D412
C005 LDA#1FF :set a high freq
C007 STA#D40F
C00A LDX#100 :set index
C00C LDA#D41B :get osc output
C00F CMP#10A :compare to range
C011 BCS#C00C :if > get again
C013 ADC#17A :add lower limit
C015 STA#C100,X :put it away
C018 JSR#EEB3 :delay 1ms
C01B INX :complete loop
C01C BNE#C00C
C01B RTS
```

### 4. One-block sort

```
C000 CLC
C001 LDA#100
C005 STA#FC :set #FC/FD to 0400
C006 ADC#101
C007 STA#FE :set #FE/FF to 0401
C009 LDA#104
C00B STA#FF
C00D STA#FD
C00F LDA#C100 :test low = 1
C012 CMP#10C
C014 BCC#C0A2
C016 DEC#C100 :low-1, last item has no successor
C019 LDX#C100 :# of lines through inner loop
C01C LDV#100 :beginning index
C01E STY#C101 :initialise exchange flag
C021 LDA#C101,Y
C023 CMP#(FE),Y :compare two adjacent elements
C025 BCS#C024 :if e2 > e1 no exchange
C027 PHA :otherwise store e1
C028 LDA#(FE),Y :store e2 in e1
C02A STA#(FC),Y
C02C PLA :retrieve e1
C02D STA#(FE),Y :store in e2
C02F LDA#101 :set exchange flag
C031 STA#C101
C034 INX :next element
C035 DEY
C036 BNE#C021
C038 LDA#C101 :get exchange flag
C03B BEQ#C0A2 :if no exchange exit
C03D DEC#C100 :continue if low = 0
C040 BNE#C019
C042 RTS
```

### Set-up BASIC for one-block sort

```
10 FOR I=0 TO 255:POKE5296+I,I:NEXT I
20 FOR I=0 TO 255:POKE1024+I,RND(1)*255:NEXT I
30 FOR E=4000 TO 5500:POKE49152
40 GOTO 1:IF NOT THEN 40
50 GOTO 20
```

### 5. 0-9 Menu

```
C000 LDA#100 :clear keyboard buffer
C002 STA#CA
C004 LDA#C :test for a key press
C006 BEQ#C004 :loop if none
C008 SEC
C009 LDA#0277 :get value (CHR) in k/b queue
C00C SBC#430 :convert to value 0-9
C00E CMP#10A :if = 10 then go again
C010 BPL#C000
C01C ASL :double
C015 TAX :set index
C014 LDA#C100,X:iget address low
C017 STA#C040
C01A INX :iget address high
C01B LDA#C100,X
C01E STA#C041
C021 JMP#(C040):do indirect JMP
Data (insert jumps here)
C100 EB EA EB EA EB EA EB EA
C10B EB EA EB EA EB EA EB EA
C110 EB EA EB EA 00 00 00 00
```



# How come 80K is actually 21K Ram?

Dear Sir,

I am a subscriber to your magazine, which I have found to be very informative. However, I feel it is time for magazines such as yours to start producing information for the beginner. I am speaking from experience after having learned some facts about computers the hard way.

I will start by explaining those experiences.

I first gained interest in programming through using programmable calculators as an employee of the Dannevirke County Council. The first computer I purchased was a VIC 20.

At the beginning of last year I decided a spreadsheet program would make my life a lot easier at work. At the same time I wanted an upgrade with a good version of Basic.

My starting budget was \$1300, so after reading through various reviews I decided the Spectravideo 328 was the one to buy. After all, it had an excellent version of Basic, the capability of running CP/M software, 80K of RAM (16K video and 64K user), of which I thought at the time was more than enough for programming purposes, and excellent graphics facilities.

## SPREADSHEET DELAY

For \$900 I received the computer, cassette recorder, joystick, and ten software tapes. At the time of purchasing I also ordered the CP/M spreadsheet "Calcstar", which I was assured would work perfectly well on this computer.

After four months I finally received a version of Calcstar.

I had already purchased the 605 Super Expander with one disk drive for running this software - and then I learned an essential fact: that Calcstar required an 80-column screen to work properly. I therefore ordered a \$350 80-Column Card.

When I received this and plugged it into the expander I learned something else - with the card inserted the only screen available is the text screen. Neither of the graphics screens is available.

In using Calcstar I discovered another problem on which information was lacking. CP/M makes full use of the 64K in the computer but even with this there are only 684 cells available, making for a rather small spreadsheet.

The way around this is to split the spreadsheet into several sections and store these on disk, calling the relevant section when required.

The problem arises that if a disk is inserted in the disk drive while a program is running, the disk is automatically set to

## Bank-switching debate.

'read only' - meaning a second disk drive is needed.

But the real crunch came in running out of memory for a database.

The review article in the December/January 1983-84 issue of Bits & Bytes stated the Spectravideo 328 to be "a very competitive business machine". The summary section stated that the system was expandable to 144K (bank switched).

I had no idea at the time what the term "bank switched" meant, and I assumed that 144K would be available for use.

## HOW 64K BECOMES 21K

In reality an eight bit processor can only address 64K of memory at one time.

Now for one of the real idiocies of the Spectravideo - when in Basic the system only has 32K available at one time and all 64K is only used under CP/M. Minus off this 32K the string and variable space, and the disk operating system, and you are stuck with something like 21K - much less than the advertised 64K.

The only way of using the other 32K is to purchase a machine code program and use a few switching commands to switch between the internal memory banks.

I was even fool enough to purchase a 64K RAM expansion. All that this succeeded in giving me was one more switchable bank of 32K. Wait a minute, didn't I purchase 64K? Well, that didn't really matter, as I still only had 32K, well 21K, available at any one time.

In an attempt to get the database program on to the computer I decided to try a piece of programming; to split the large program amongst the three memory banks.

This required the program to save variables on disk before switching to a new memory bank and then loading them back into this new bank before continuing with the program.

The main problem here was that a large portion of the program was contained in a For-Next loop, meaning that the program had to switch between the banks many times. This led to a program which ran very slowly and was horribly confusing to debug. In fact, I gave up trying.

## MACHINE CODE OPTION

Well, enough criticism, now for a little praise, for the November '85 issue of Bits & Bytes which has plenty of information in it regarding the above topics.

The Spectravideo column titled "How to get more RAM" explains how to use a machine code program to make the other memory bank in the Spectravideo available for use in Basic, in the same way that the CP/M operating system does. This is fine if you are a machine code programming buff.

The only other way of accessing the second bank is to purchase the program 'Memory Expansion', of which I have explained the non-usefulness.

The next column, on the S/video X'press, by Mark James, virtually sums up the situation I faced with the 328.

The appearances and advertising of these machines give them to be capable of carrying out small business computing, but...

The summary section on the X'press clarifies the amount of memory available under Basic - this sort of information should be in all computer reviews.

I must also congratulate Peter Biggs on his review of the Amstrad 6128.

I think the first two paragraphs titled "bank-switched" are essential reading on how the 8-bit computer uses 128K and how much is available for Basic programs at one time.

Finally the article on the Spectrum titled "A survey of memory" is very good. I wonder if it is possible to have an article like this for every brand of popular computer.

Your Commodore 128 review could have been more explicit in detailing the availability of 122K RAM.

I have now purchased a much more powerful computer, for a low price; a Sinclair QL. The four business programs supplied with it are excellent, and the database is already well on the way to being compiled.

*Yours faithfully,  
K.J. Warrington  
Dannevirke*

## DG in Hamilton

Data General recently opened its fourth full-service office in this country, at Hamilton.

Prior to the new branch, a resident customer-engineer catered to local DG customers, but support now extends to marketing, sales and systems.



# A question of knowledge

Dear Editor,

Thank you for your letter and the enclosed correspondence from Mr Warrington.

Here are some comments.

I will comment on your own points first then on Mr Warrington's letter - which I found interesting and indeed he put down in writing many comments which have been made to me over the last 3 years.

## CPM AVAILABILITY

The advertising for SVI and many other computers claim in some instances thousands, in others hundreds, of CP/M titles available.

But in the New Zealand market I have seen, at most, 50 titles: e.g. Wordstar, SuperCalc, Multiplan, Zork, and Turbo Pascal.

It has been my experience also that dealers often do not know where to get CPM software from - although I can find no excuse for taking over four months to obtain a copy of Calcstar.

CPM was designed as a business system and much of the available software was designed with this in mind.

It has in the last three years been picked up by the computer manufacturers in the home/small business market and suddenly exposed to a new and far less sophisticated group of buyers and retailers.

For a large number of buyers, CPM documentation (for both CPM and for CPM software) is often highly technical and beyond the comprehension of the average user and retailer.

This software is usually expensive, which is not too surprising when you consider that the software was written for a captive audience of business customers.

In the last three years, the tendency from CP/M manufacturers has been to boost sales by bundling this software (usually WordStar and the other MicroPro products).

However, I find dealers reluctant to become involved with CP/M, perhaps because they would need to read the highly technical documentation.

If dealers are finding the transition of CPM from business to home/small business applications too much then they should not be selling CPM computers.

## FURTHER PROBLEM

There is a further, unfortunate problem for CPM, namely that dealers still put emphasis on non-CPM computers for the home market, MS-DOS for the business market.

Go to virtually any dealer and ask for

information about CPM on the C128, Amstrad 6128, MSX Xpress or any other machine which runs CPM as well as other software and they will be able to tell you virtually nothing.

There are some who make the effort, usually by contacting a user group for help, to learn enough about CPM to be able to answer the very elementary questions a customer may ask. Likewise many take the sensible step of referring customers on to a user group when they have queries about CPM.

CPM's place is not rightfully in the home/small business market. MS-DOS and PC-DOS look like becoming the standards for business (but the AMIGA may alter that somewhat).

Software is available, it's not cheap by home standards, but there is masses of free software available in the public domain. This is mostly in the user groups.

## ACCESSIBILITY OF RAM

Eight-bit processors cannot access more than 64K ram/rom at one instant.

There is no reason why chips like the Z80 should not control more than 64K as bank switching will allow access to more data.

But... only CPM version 3.0 (as far as I am aware) will actually allow access to that extra memory without direct need for machine code programming by the buyer. All the bank switching capability is built into that system.

The Amstrad 6128 and Commodore C128 both run CPM 3.0 (also known as CPM Plus) so will have access to 128K under CPM.

But... this 128K is partitioned so that the user can use about 60K for data storage and programs, while the remainder is used as a ram cache - which means that disk accesses are less frequent as more than is needed is read at each disk access.

Subsequent disk accesses first look at the cache to see if the needed data is there, if so no real disk access need take place.

Individual systems may have their ROM BASICS extended to do automatic bank switching also - for instance, MSX has built in bank switching to control the disk system, and disk commands switch out 16K of the usual ROM, and switch it back in when the disk command is finished. If they cannot get that question answered then the machine is unlikely to have such software available.

## ADVERTISERS' ROLE

Advertisers should not advertise extra ram availability unless the software to transparently operate that ram is available.

I know that the extra ram for SVI is aimed only at 318 owners wanting to expand to a 328 easily, but I have never seen this mentioned in any advertising at all.

Likewise I know that the extra RAM advertised for MSX is aimed at MSX machines which are not 64K (e.g. the Yamaha).

The fact that SVI makes them implies that they will enhance SVI computers, but it should be made clear to customers that they will need to program the bank switching themselves.

Commodore advertise the C128 as offering CPM compatibility for under \$1000 - but without mentioning the additional cost of a disc drive in order to run CPM.

Other examples exist of assumptions about customer knowledge.

One of the local Amstrad dealers, when approached, was reluctant to tell me about CPM, and could tell me little more than that 60K was available for the user and the rest was a ram disk.

In fact only 32K is available under Basic on the 6128.

Distributors have the responsibility of informing their dealers that peripheral X is useless without software Y and so on.

## MR WARRINGTON'S LETTER

It's of little use, if you are an absolute beginner, trying to decide for yourself which machine to buy.

Last year I had several people contact me and ask me questions which the dealers could not answer (before buying) and several came to our user group meetings.

I take the attitude that users' groups should offer such advice.

I consider membership of a users' group a necessity for beginners, and most users' groups accept out-of-town members or pass their names on to a group who produce a newsletter.

Mr Warrington says he had a starting budget of \$1300, spent \$900 on the SpectraVideo family pack, then bought Calcstar, then bought an expander with one drive, then bought an 80 column card... in fact spent about \$4000.

At that time, an entire business system (computer, 2 x 155K disk drives,

*(Continued on page 76)*



expander with printer interface, 80 column card) cost under \$3500 – including Wordstar, Calcstar, Datastar and indeed the entire range of MicroPro's CPM standard business software (the Star range).

It is inexplicable that a dealer did not tell him that Calcstar requires an 80 column screen – as does all CPM software.

The comment about graphics and text screens and the 80 column card has arisen on many occasions. The comment about it not being mentioned in the documentation is correct and typical of SVI's early documentation.

Similarly, CPM was designed to run with two disk drives – and the SVI business pack is configured that way. This "idiocy" is designed to prevent any accidental disk file corruption.

Mr Warrington's comment about the lack of memory under Basic shows precisely why he should have joined a user group. '... 64K is available, why not use it...'. The answer is, it does use it.

An 8-bit processor addresses 64K of memory – 32K is ROM and 32K is RAM.

Dealers should have been able to tell Mr Warrington why it seems that Basic only addresses 32K – although few in Wellington know that answer.

Mr Warrington appears confused by the SWITCH command, which gives the ability to have two programs in memory at once, and to switch between the two.

The command also works with the 64K ram expansion, but of course can give only another 32K ram (as the rom must be there as well).

Memory Expansion allows you to use the remaining 32K of ram on an unexpanded 328, ie the 32K not used by Basic.

The 318 is just a home computer.

But the 328 is another story. We have people in the Wellington SVI user group using their machines for both business and other applications.

In the case of the Xpress, had I been reviewing I would have produced a totally different review.

The manuals are much better than the review implied and regretfully the reviewer (and distributor) did not seem to know that all CPM2.2 software is already available for the system... all that is needed is to get that software into Xpress format.

Some 100+ MSX titles are available here as well as the CPM titles, but comments about software would have put me right off the Xpress had I not known that CPM software is fairly simple to transfer.

In fact, I'm using Wordstar to write this, and also use Turbo Pascal, DBase 2 and Supercalc on the Xpress.

OK, again it comes down to a user's know-how...

Yours faithfully,  
Don Stanley,  
SVI Users' Group (Wgtn) Secretary

**SYSTEM-80** mailing list program \$30. Hold 3500-7000 names, addresses and phone numbers, Instant instr search on name. Machine language, includes FORTRAN source. Requires 48k NEWDOS/80 V2.0. Send \$5 and a blank 5.25" disk for demonstration program to PO Box 4032, Auckland.

**TANDY 1000** – One disk drive plus monitor \$2,500 ONO. Ph (09) 674-951.

**There is a minimum charge of \$8.00 for classified advertisements if Bits & Bytes. Classified advertisements must be accompanied by a full name, contact phone number and address. They are charged at 50 cents a word and where space is short, preference will be given to pre-paid advertisements.**

**Apple IIe copy 48kb for sale;** computer; disk drive; monitor; numerical key pad; lower case. Lots of the latest software including an assembler and a 3D flight and combat simulation. Joystick; dust cover; seven books. Price: \$2000.00 for everything. Write to Martin Searancke, R.D.4, Maungaturoto, or phone Taupū 850.

**NEW SPECTRAVIDEO SOFTWARE** for the SV.318 SV.328. Good quality! Write away with S.A.E. for a catalog to: "NBS Software", 313 Brougham St, Christchurch, 2. Ph 56-664.

**DOUBLE** the storage capacity of your single sided disks with this complete kit. Includes everything you need to halve your disk costs. Only \$14.95 from M.C.P., 15 Wilfrid St., ChCh 4.

**SPECTRAVIDEO 328**, Data Cassette, manual, Basic Reference Manual, Justwrite Jr (word processor) and 6 Tapes. \$500 ono. Ph 27157, Whangarei.

VZ200 Peripherals, Data Cassette \$50. 16K Ram Module \$50. Circus Tape \$8, Slot Machine Tape \$8. Demonstration Tape \$5. Program Book and Manual \$10. Ph 27157, Whangarei.

**COMPLETE APPLE II** plus copy system includes 64K Ram, numeric keypad, 12" green screen, 2 drives and PLENTY of software. \$1600 ono. Contact Peter on (062 4) 8562 MA.

**If you want to sell your product, we've got a readership of 96,000 people who want to read about it every month!**

## Advertisers index

|                          |             |
|--------------------------|-------------|
| Ashby                    | 55          |
| Battley                  | 49          |
| Bits & Bytes             | 40,41       |
| Bits & Bytes Bookbinders | 67          |
| BOS                      | 27          |
| Canon                    | 31          |
| Commodore Computer       | 4           |
| Compumedia               | 38          |
| Computer Broking         | 48          |
| Computers for People     | 63,70,33,37 |
| Computer Imports         | 39          |
| Computer Games Club      | 17          |
| Computer Sciences        | 50          |
| Computer Works           | 42          |
| Control                  | 28          |
| Datacom                  | 78,79       |
| Data General             | Cover       |
| Dick Smith               | 24          |
| Floppy Disc Co.          | 9,12        |
| Genesis Systems          | 5           |
| Hewlett Packard          | 36          |
| Hi Tech Micro            | 80          |
| Holt Saunders            | 71          |
| ITT                      | 19          |
| Jenness                  | 35          |
| Logical Methods          | 14          |
| Mandeno                  | 69          |
| Microbee                 | 30          |
| Micro Hire               | 68          |
| ML Systems               | 11          |
| PC Power                 | 45          |
| Philips                  | 34          |
| Porterfield              | 2,61,62     |
| Remarkable Enterprises   | 6,8         |
| Roland                   | 65          |
| Scollay                  | 52          |
| Solstat                  | 77          |
| Southmark                | 51          |
| 3m                       | 64          |
| Technical Solutions      | 61          |
| Toshiba                  | 22          |
| UDC Finance              | 3           |
| Verbatim                 | 32          |
| Vickery Electrical       | 70          |
| Wang                     | 21          |
| Wellington PC Show       | 29          |





# Dysan 3 1/2" Micro Diskettes

Industry standard 3 1/2" Micro Diskettes engineered with the Dysan Standard of Quality.

**A pocketful of miracles.** Even though a Micro Diskette fits in your pocket, Dysan packs in a full half megabyte of data storage – as much as a 96 TPI 5 1/4" diskette – without giving up one bit of performance and reliability.

This new generation Micro Diskette is compatible with the Apple® Macintosh™, Hewlett-Packard HP-150 and other personal computer systems.

**Each one is tested.** Dysan 3 1/2" Micro Diskettes are certified 100% error free. So every Dysan diskette you use will record and retain all your data all the time, for as long as you own the diskette and treat it right. That's our Lifetime Warranty\* to you.

Your data is protected by a rigid plastic case which does not bend, fold or crease. Potentially damaging dust and fingerprints are sealed out

by a "shutter door" that automatically covers the magnetic media when not in use. And a write/protect switch prevents accidental erasure but allows new data to be recorded when you wish.

**The Dysan Difference.** Like all Dysan products, the Micro Diskette is produced with exclusive manufacturing processes and equipment, delivering the highest quality data storage products that tomorrow's technology can produce.

Choose Dysan. The difference is ...  
The Quality.

**SOLSTAT INDUSTRIES LIMITED**  
32 Sheffield Crescent, P O Box 13-183, Armagh, CHRISTCHURCH  
CALL... (09) 444-7216 AUCK •• (03) 588-202 CHCH  
. (04) 856-260 WELLINGTON ..



# PC16-220

## Personal Computers



Simply the best value in personal computers.

Only available from:  
**HITEC MICRO LTD.,**  
91 Custom Street East, Auckland 1. Ph. (09) 399-183